

1:	9.5	↖
2:	10.6x	↙
3:	10.2	←
4:	10.3	↘
5:	10.5	↖
6:	10.3	↑
7:	10.8x	↘
8:	10.8x	→
9:	9.6	↗
10:	10.5	↖

Serie	98 (3x)
Total	98 (3x)

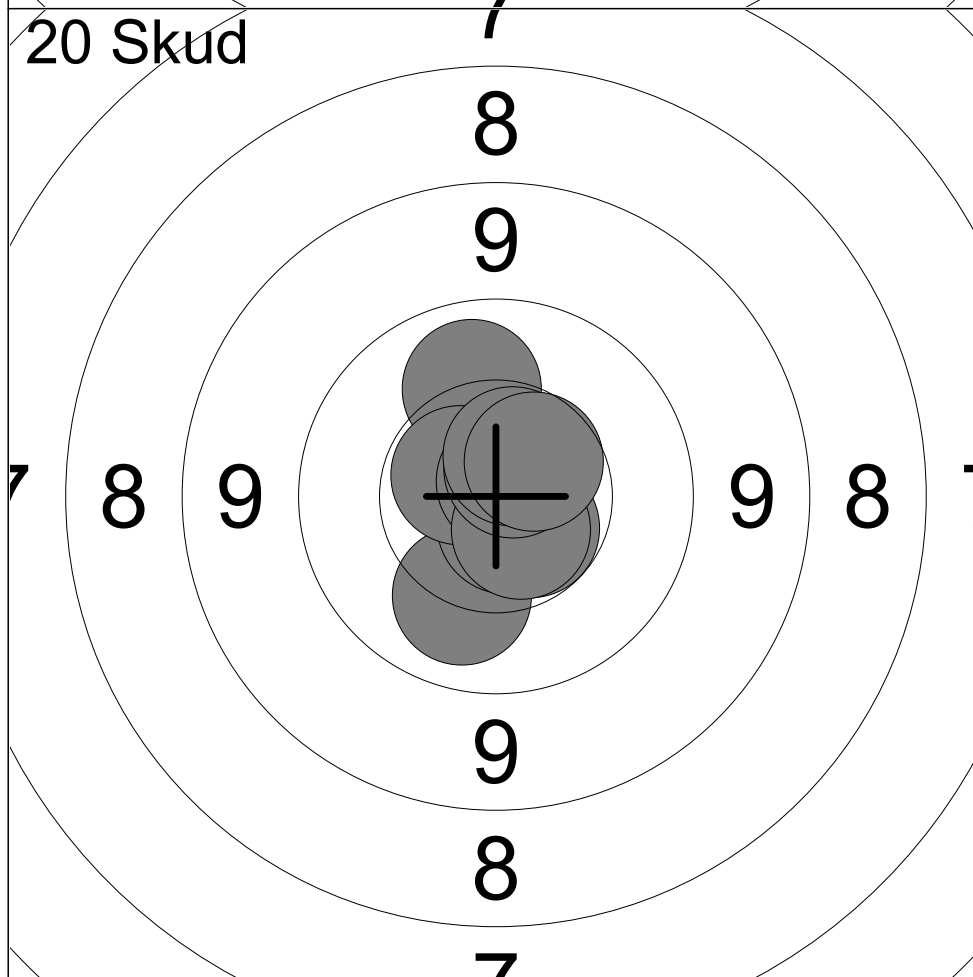

11:	10.6	↘
12:	10.1	↑
13:	10.1	↘
14:	10.7x	↘
15:	10.6x	↖
16:	10.8x	↗
17:	10.6x	↘
18:	10.7x	↗
19:	10.6x	↗
20:	10.5	↗

Serie	100 (6x)
Total	198 (9x)

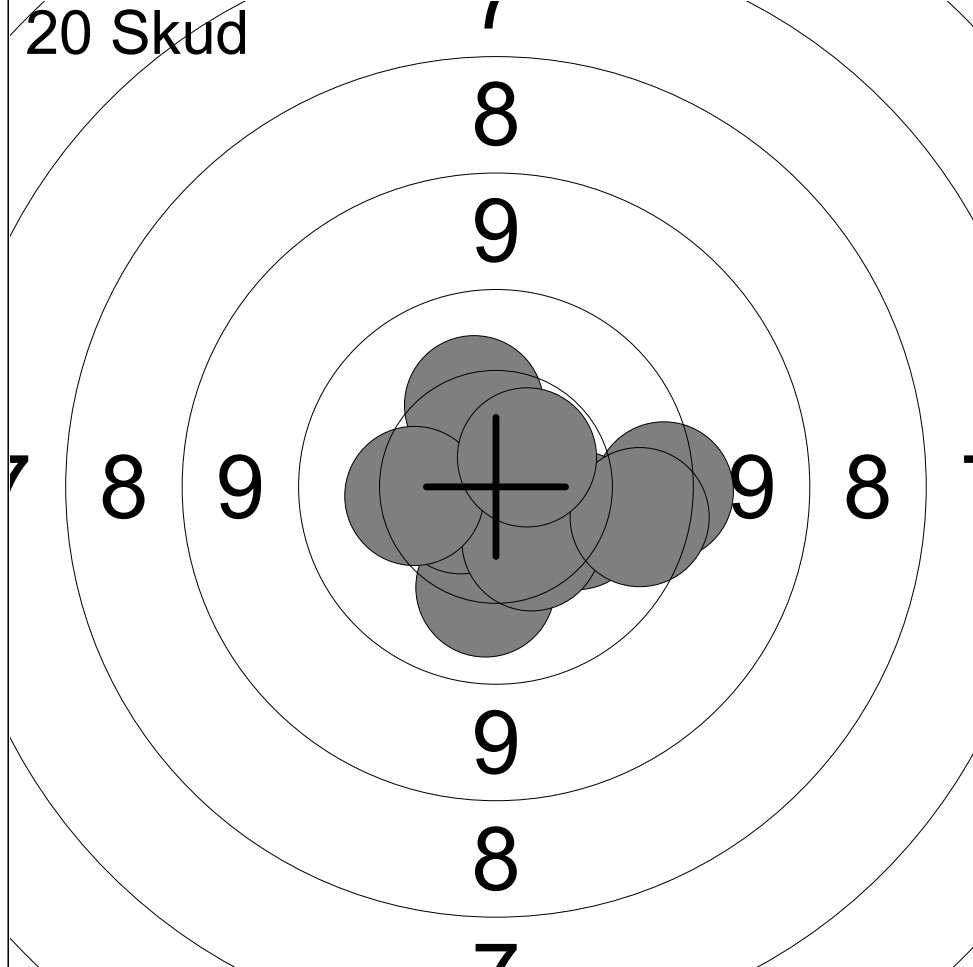

1:	10.2	↓
2:	10.6x	↙
3:	9.6	→
4:	10.3	↘
5:	10.8x	↗
6:	10.3	↗
7:	10.4	↘
8:	10.3	←
9:	9.8	→
10:	10.6x	↗

Serie	98 (3x)
Total	98 (3x)

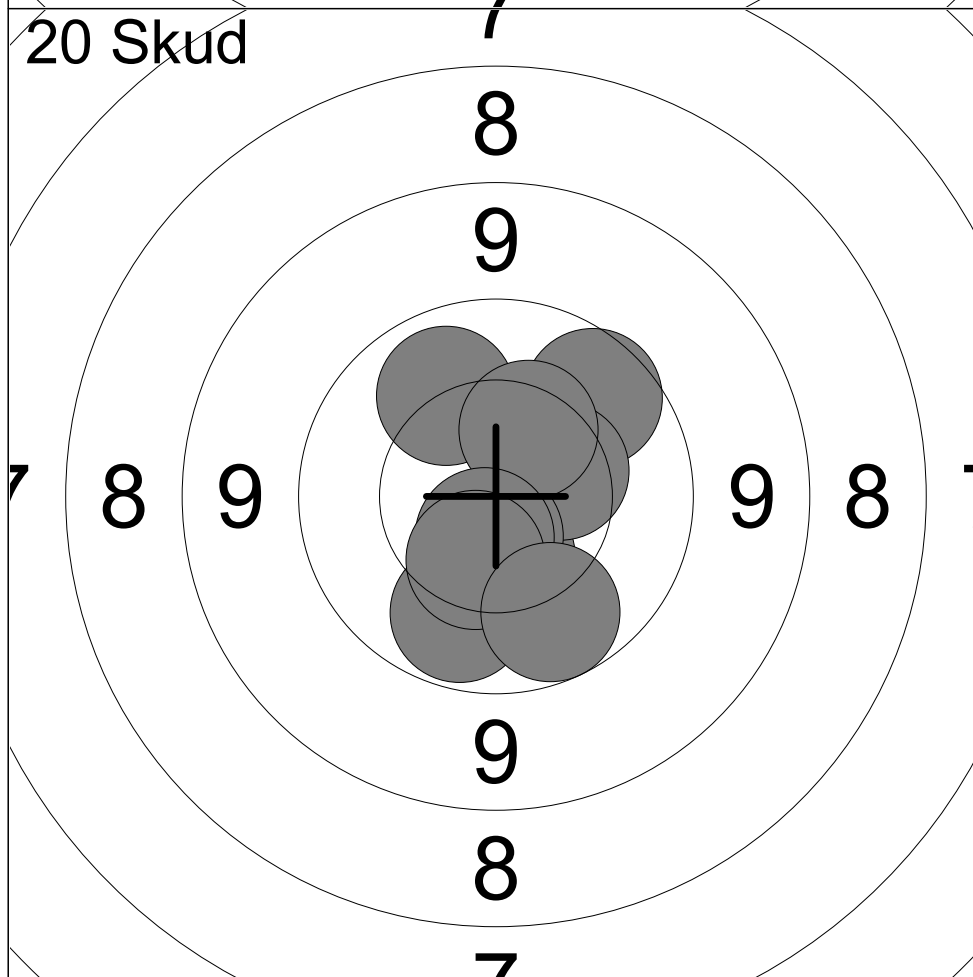

11:	10.5	↓
12:	9.9	↗
13:	10.1	↗
14:	10.4	↗
15:	10.0	↘
16:	10.6x	↓
17:	10.4	↗
18:	10.6x	↘
19:	10.4	↘
20:	10.0	↓

Serie	99 (2x)
Total	197 (5x)

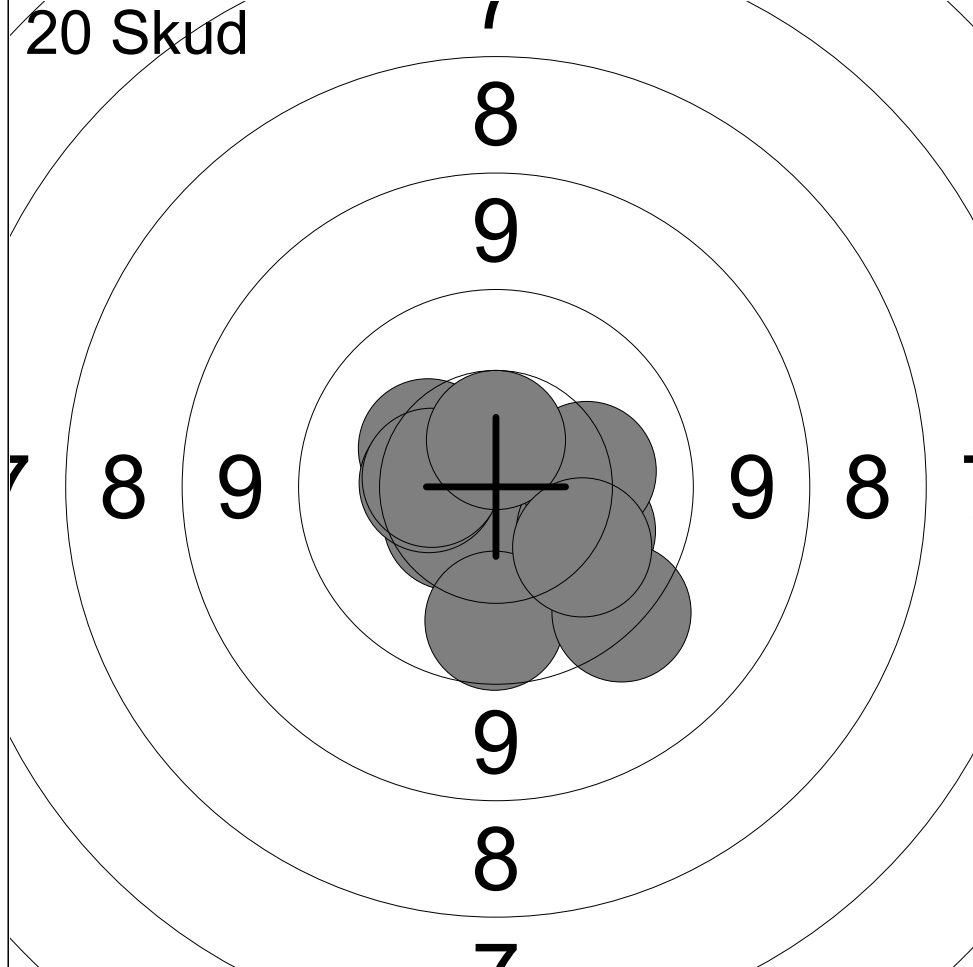

1:	10.5	↙
2:	10.3	↗
3:	10.4	←
4:	10.2	↘
5:	10.2	→
6:	9.9	↓
7:	10.4	←
8:	10.6	↑
9:	9.5	↘
10:	10.1	↘

Serie	98 (0x)
Total	98 (0x)

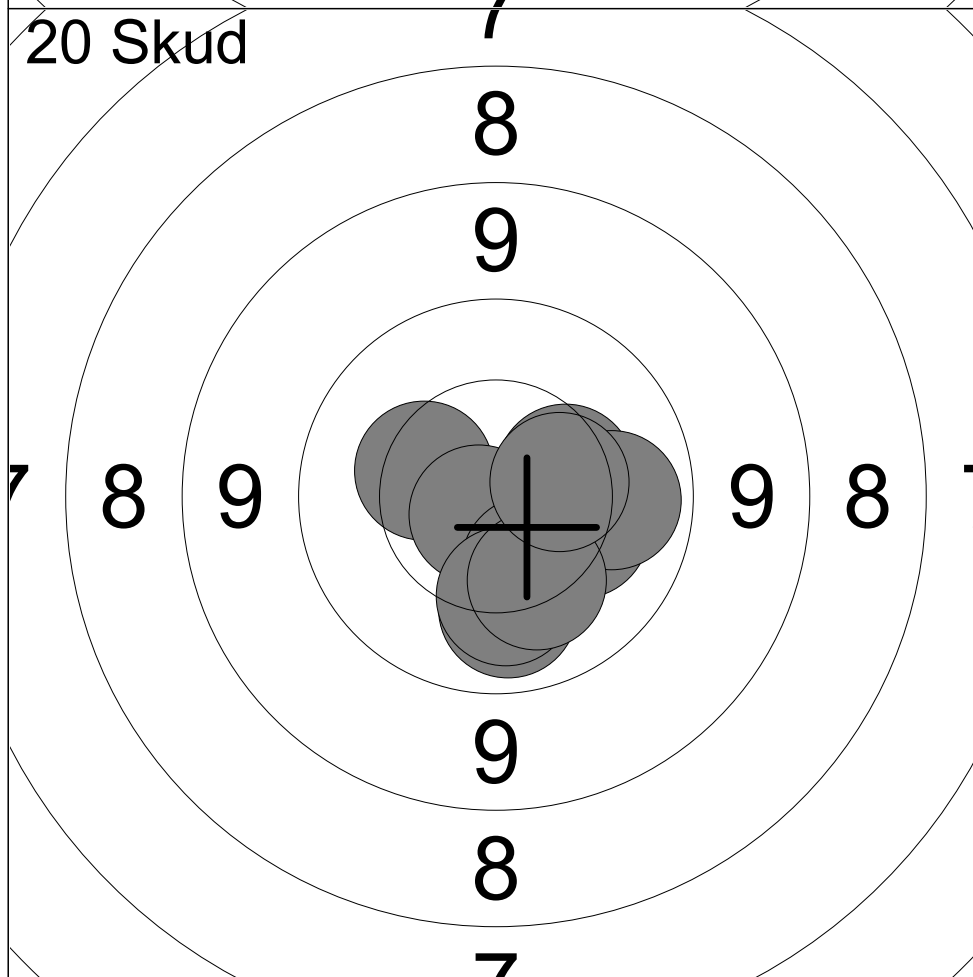

11:	10.4	↖
12:	10.1	↓
13:	10.4	→
14:	10.8x	↙
15:	10.2	↘
16:	10.3	↘
17:	10.2	↘
18:	10.0	→
19:	10.2	↘
20:	10.4	→

Serie	100 (1x)
Total	198 (1x)

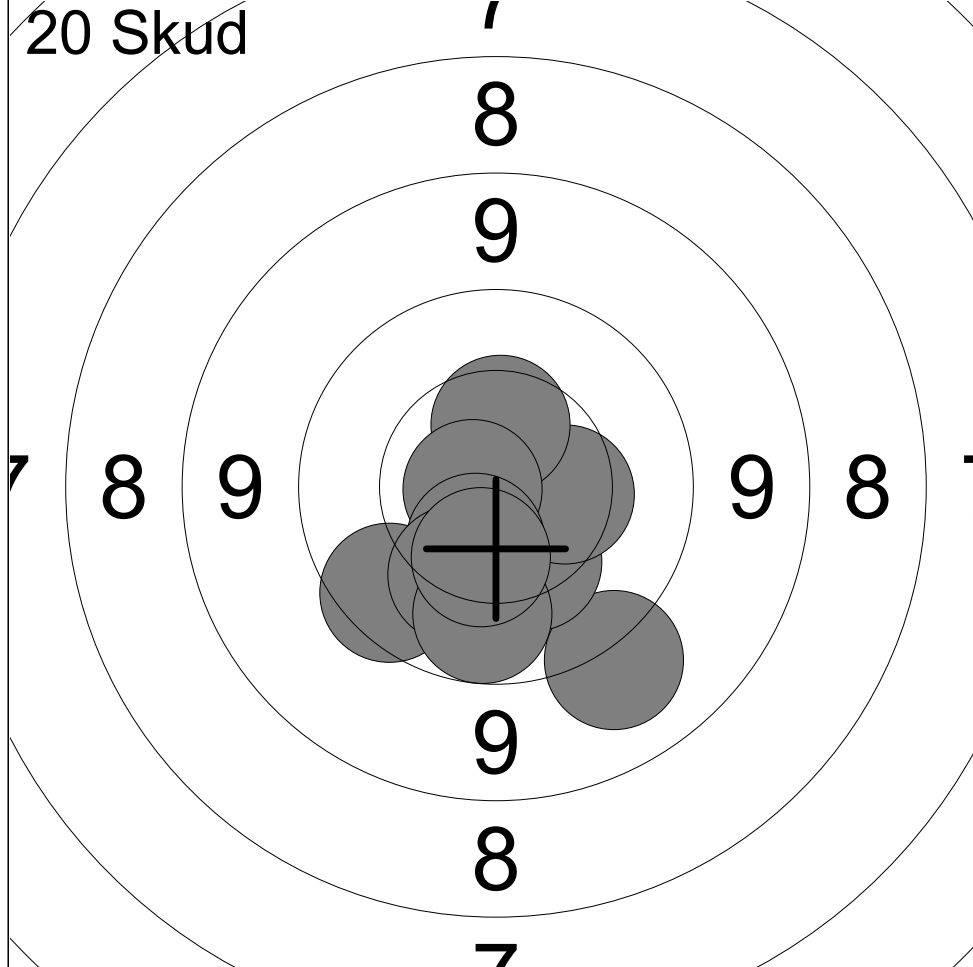

1:	9.2	↘
2:	10.3	↘
3:	10.4	→
4:	10.5	↑
5:	10.8x	←
6:	10.5	↘
7:	9.8	↙
8:	10.2	↘
9:	9.9	↘
10:	10.4	↘

Serie	97 (1x)
Total	97 (1x)

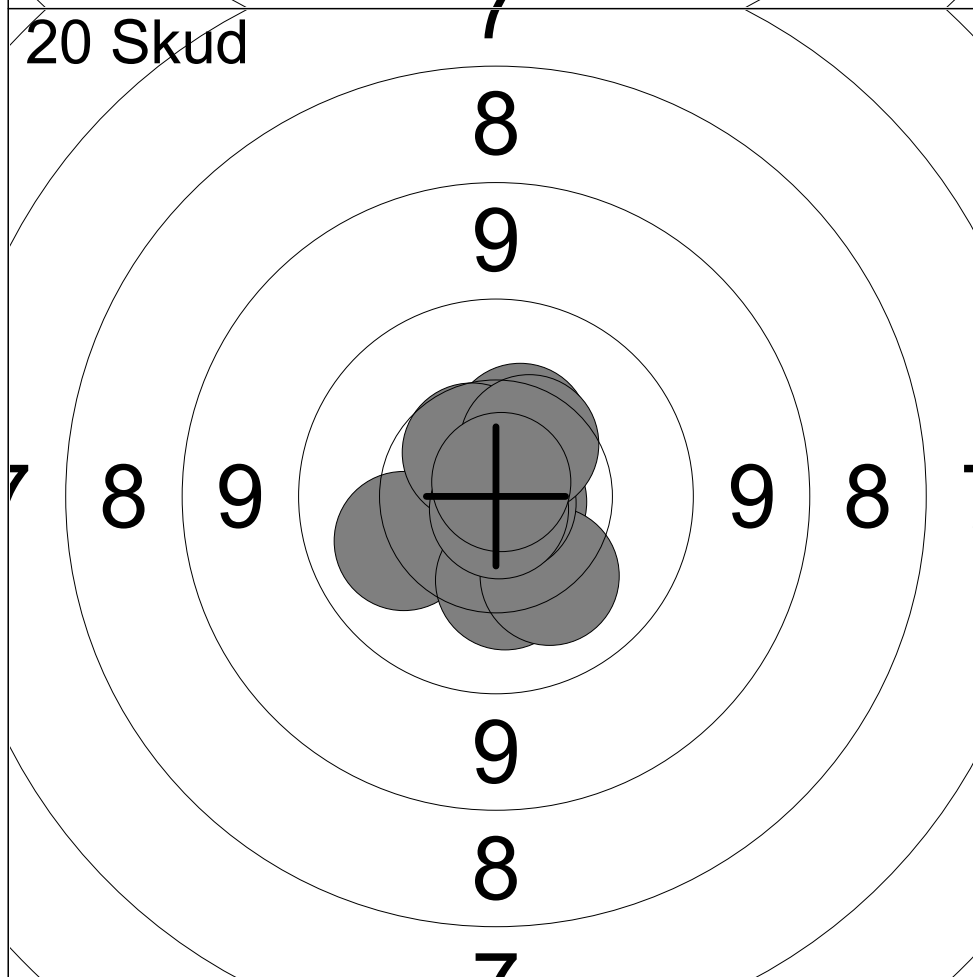

11:	10.1	↙
12:	10.8x	→
13:	10.3	↘
14:	10.2	↘
15:	10.4	↑
16:	10.9x	↘
17:	10.6	↗
18:	10.8x	↘
19:	10.5	↗
20:	10.8x	↗

Serie	100 (4x)
Total	197 (5x)

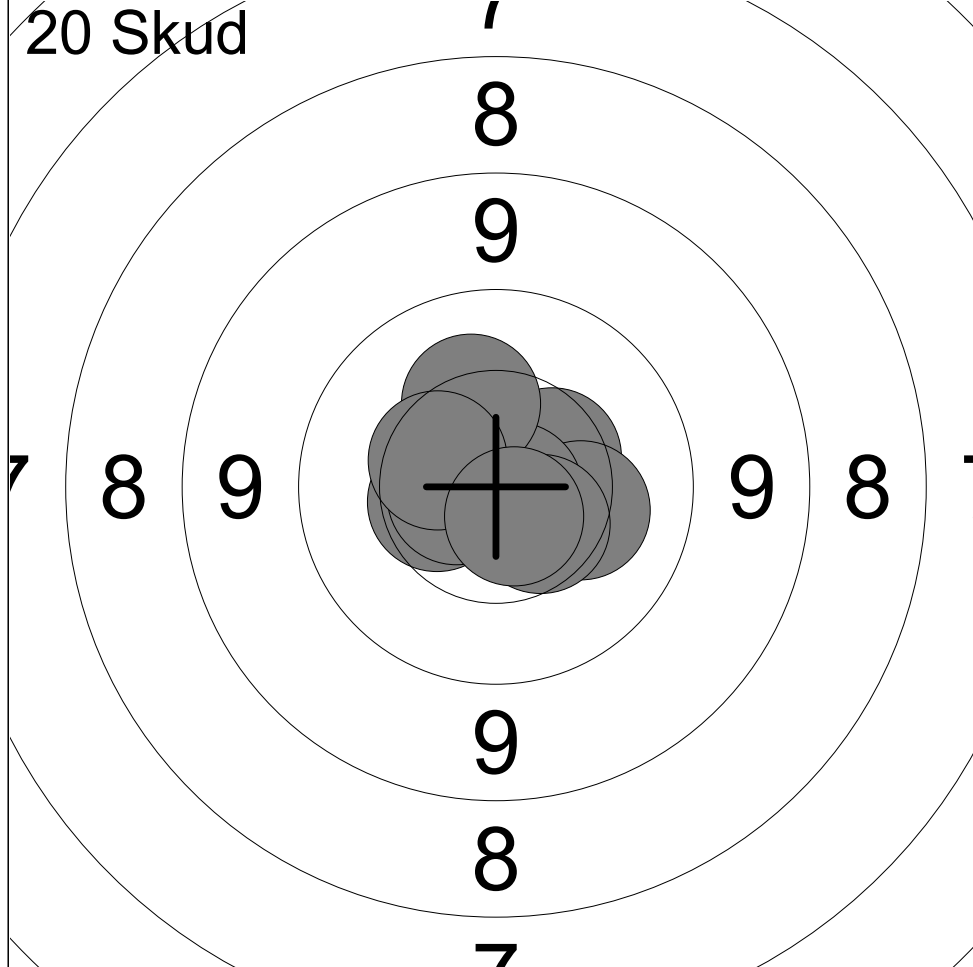

1:	10.5	↗
2:	10.7x	↖
3:	10.3	→
4:	10.5	←
5:	10.6x	←
6:	10.8x	↗
7:	10.3	↗
8:	10.4	↖
9:	10.5	↘
10:	10.7x	↘

Serie	100 (4x)
Total	100 (4x)

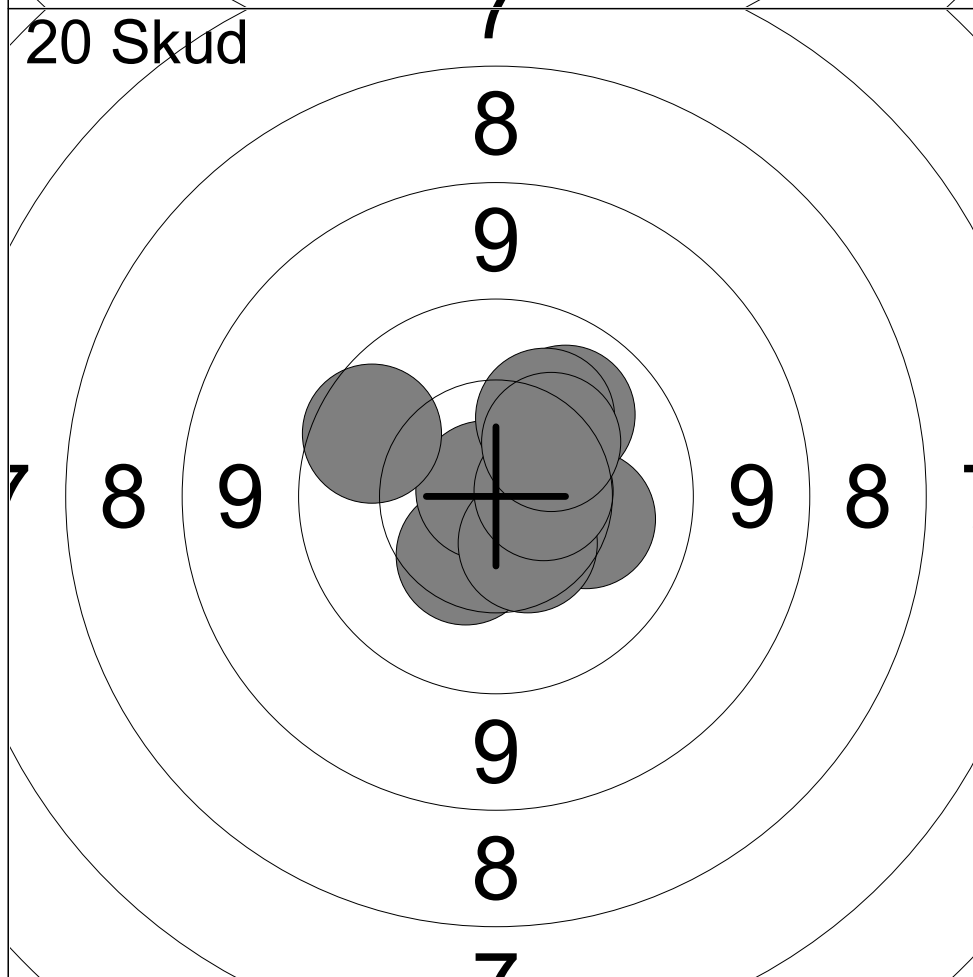

11:	10.6x	↓
12:	10.4	↘
13:	10.9x	↖
14:	10.2	→
15:	10.1	↗
16:	10.5	↘
17:	9.9	↖
18:	10.2	↗
19:	10.6	→
20:	10.3	↗

Serie	99 (2x)
Total	199 (6x)

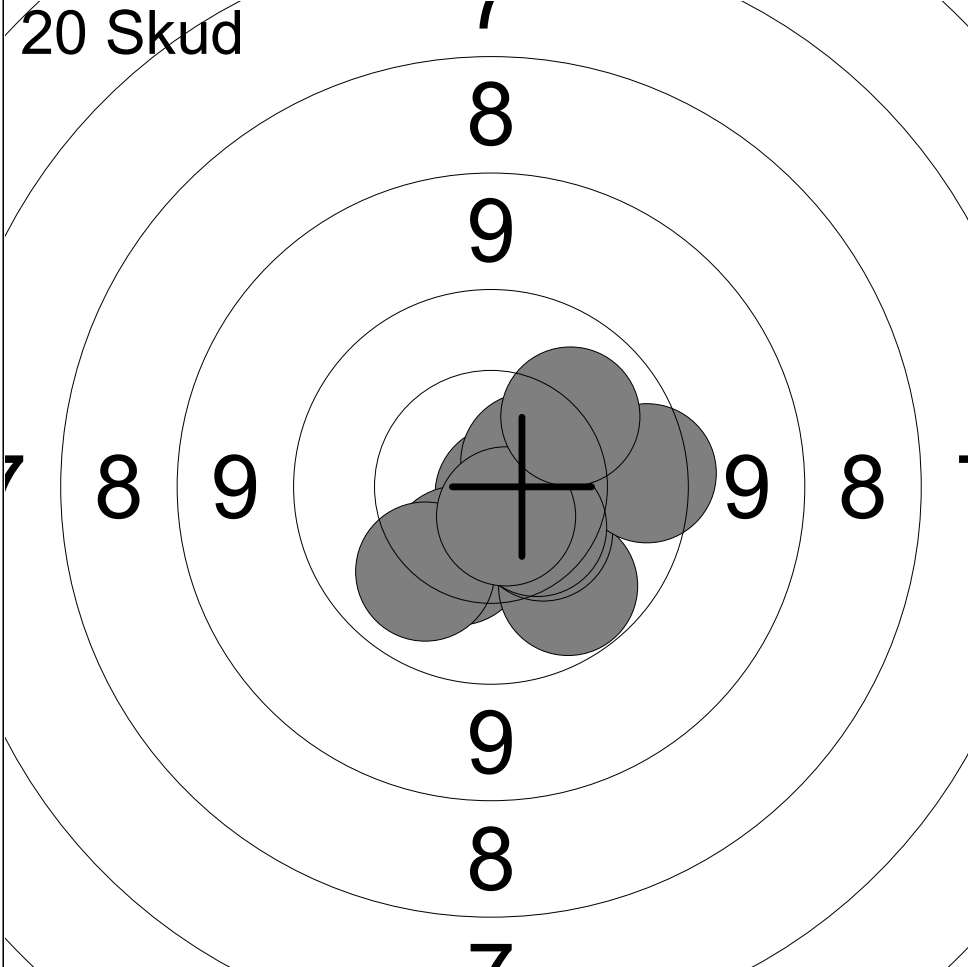

1:	10.8x	↘
2:	10.4	↙
3:	10.1	↖
4:	10.0	↙
5:	10.4	↘
6:	10.6x	↗
7:	9.7	→
8:	10.5	↘
9:	10.7x	↘
10:	10.1	↗

Serie	99 (3x)
Total	99 (3x)

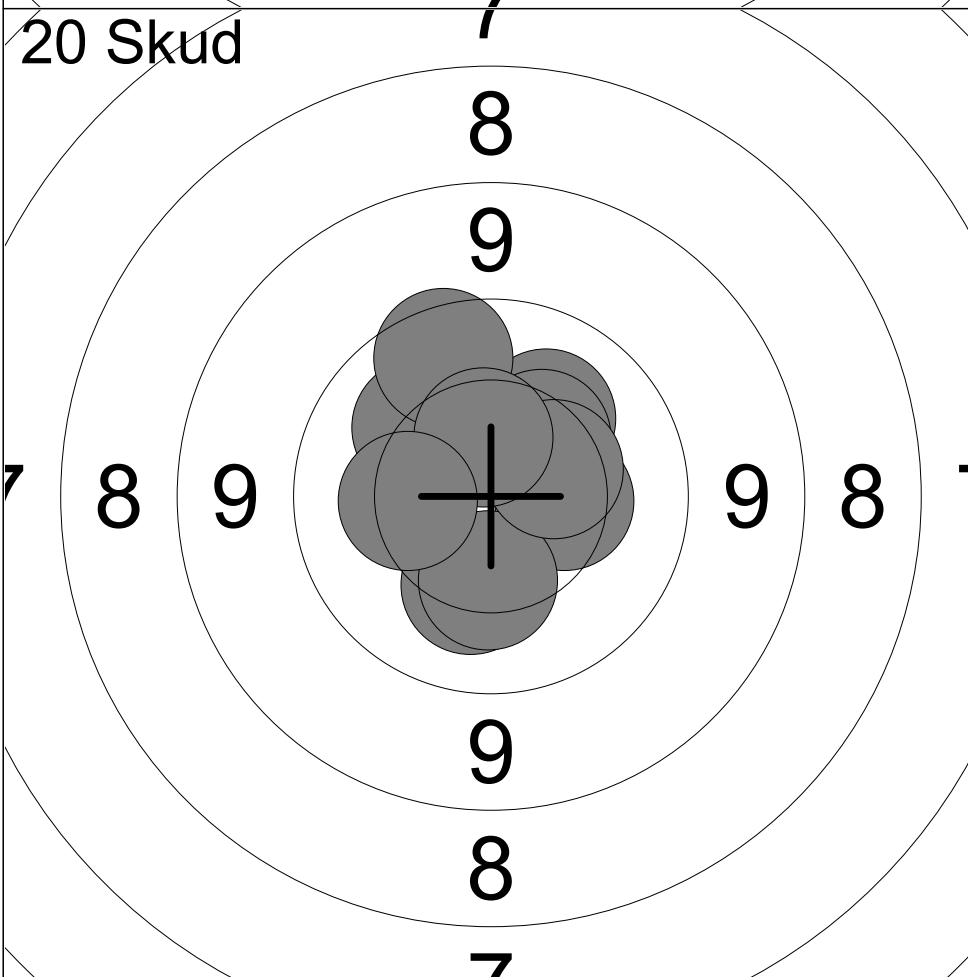

11:	10.2	↖
12:	10.4	→
13:	10.2	↘
14:	10.2	↗
15:	10.3	↘
16:	10.4	↗
17:	10.4	→
18:	9.8	↖
19:	10.5	↑
20:	10.3	←

Serie	99 (0x)
Total	198 (3x)

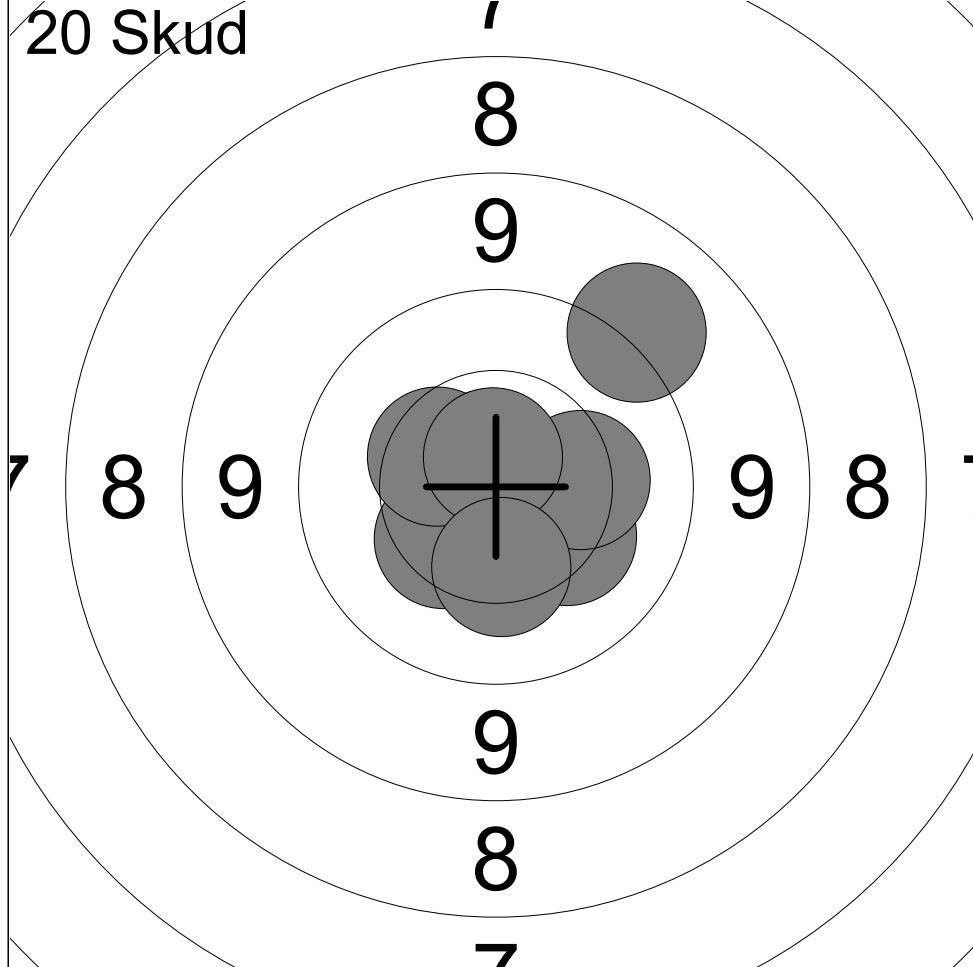

1:	10.7x	↘
2:	10.4	↙
3:	10.4	↘
4:	9.3	↗
5:	10.7x	↖
6:	10.4	↖
7:	10.3	↘
8:	10.3	→
9:	10.7x	↑
10:	10.3	↓

Serie	99 (3x)
Total	99 (3x)

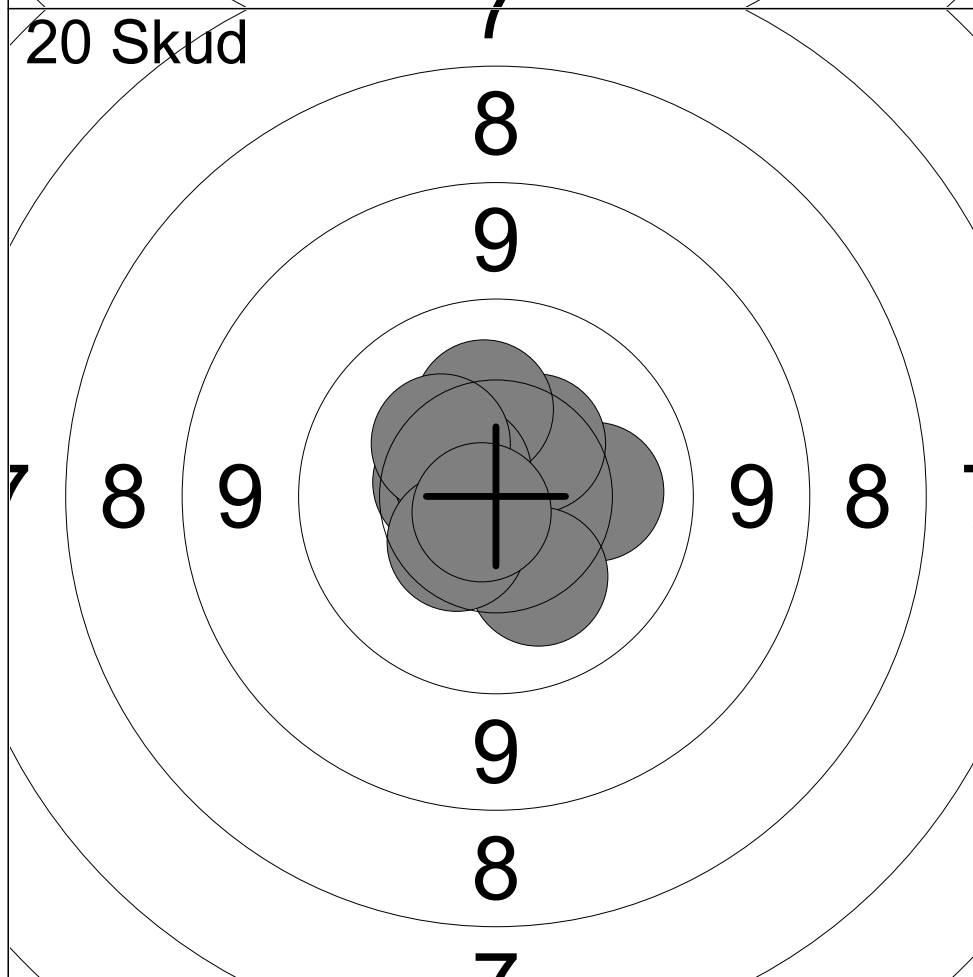

11:	10.6	→
12:	10.5	←
13:	10.2	→
14:	10.4	↗
15:	10.3	↑
16:	10.6x	↖
17:	10.4	↗
18:	10.2	↘
19:	10.5	↙
20:	10.8x	↙

Serie	100 (2x)
Total	199 (5x)

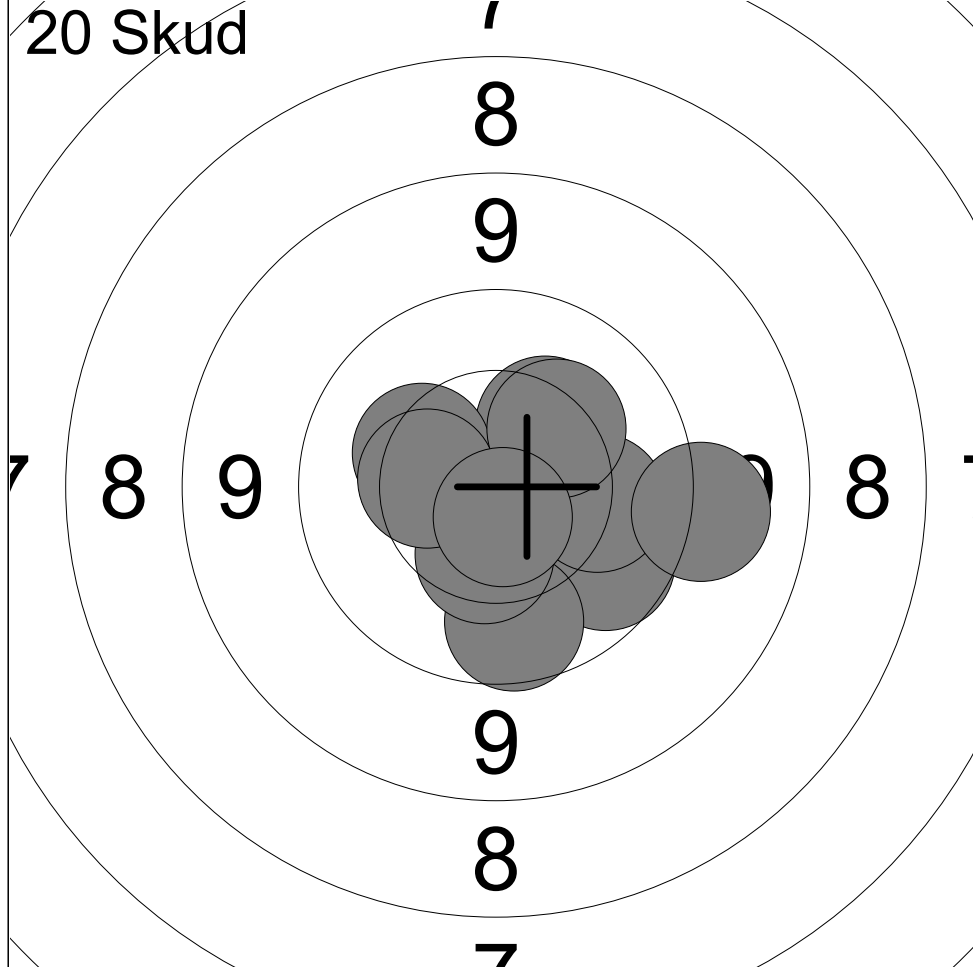

1:	9.9	↘
2:	9.9	↓
3:	10.1	→
4:	10.4	↓
5:	10.3	↗
6:	9.3	→
7:	10.3	↖
8:	10.4	←
9:	10.3	↗
10:	10.7x	↓

Serie	97 (1x)
Total	97 (1x)

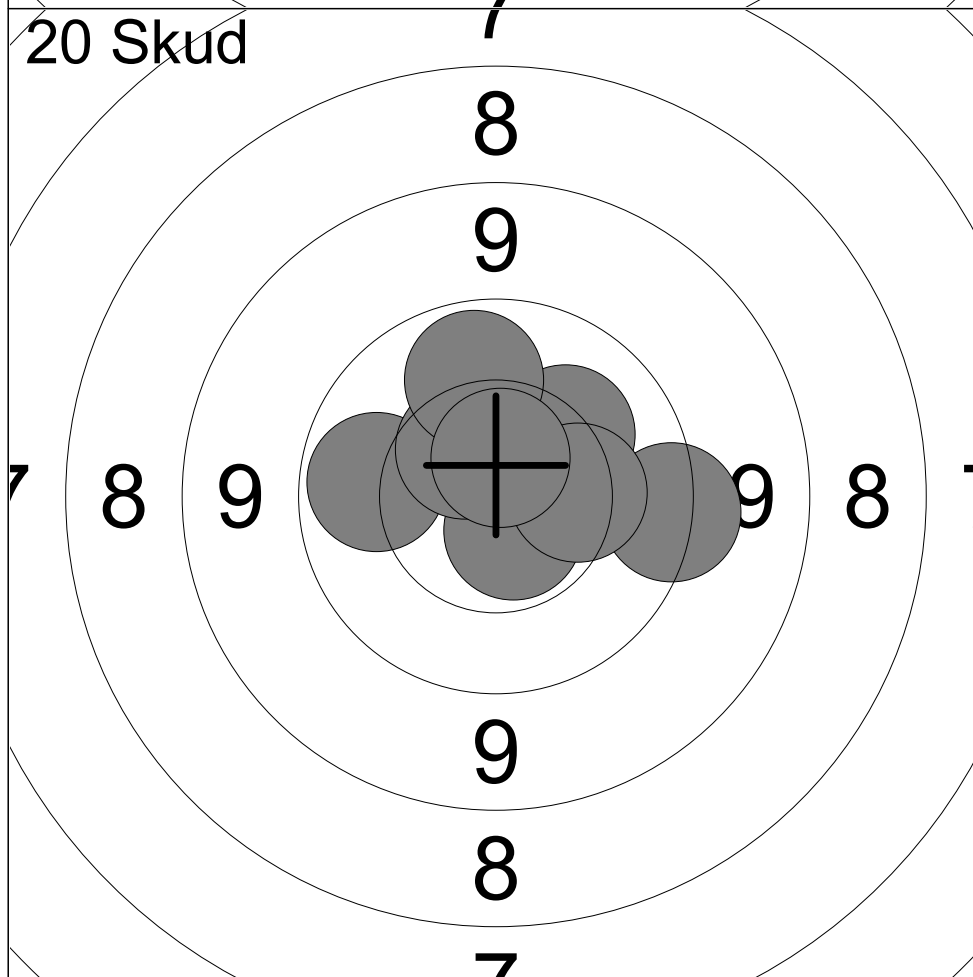

11:	10.0	←
12:	10.7x	↓
13:	10.4	↗
14:	9.5	→
15:	10.4	↑
16:	10.5	↖
17:	10.2	↗
18:	10.0	↑
19:	10.3	→
20:	10.6x	↑

Serie	99 (2x)
Total	196 (3x)

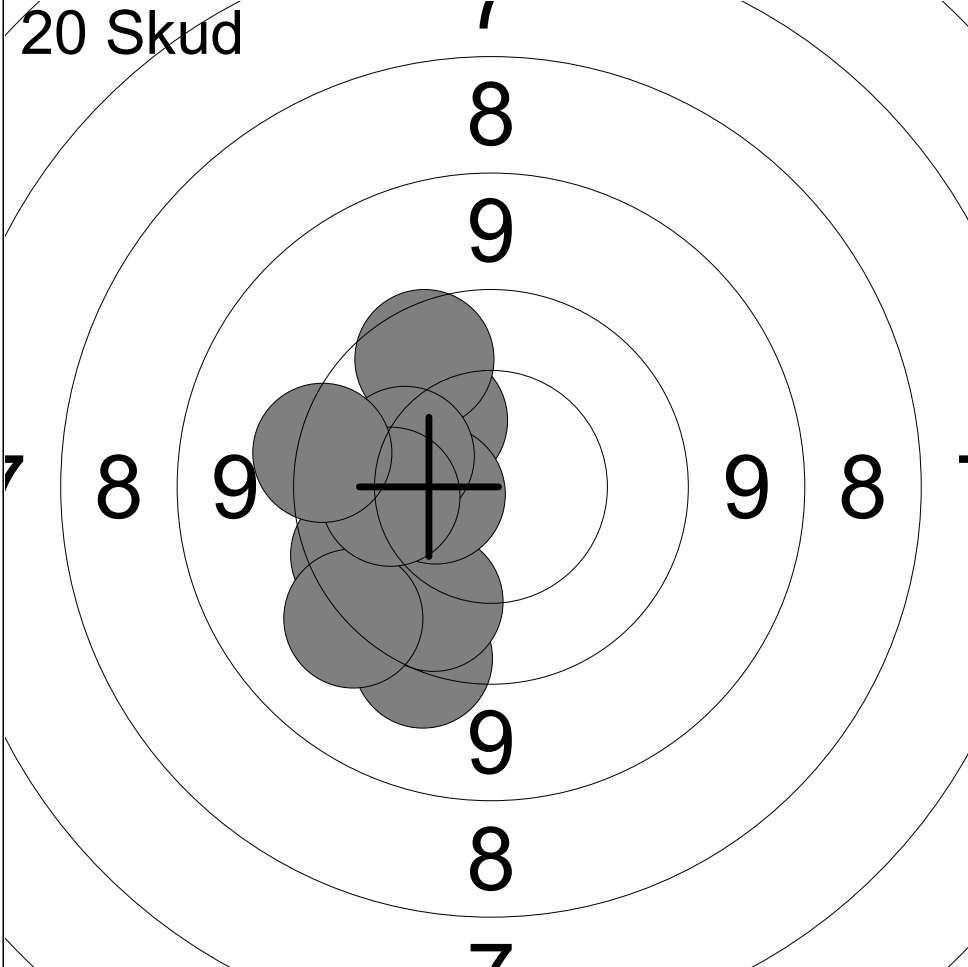

1:	9.8	↙
2:	9.5	↘
3:	9.9	↘
4:	10.3	↗
5:	10.5	←
6:	9.4	↘
7:	9.8	↗
8:	10.2	←
9:	10.2	←
10:	9.6	←

Serie	94 (0x)
Total	94 (0x)

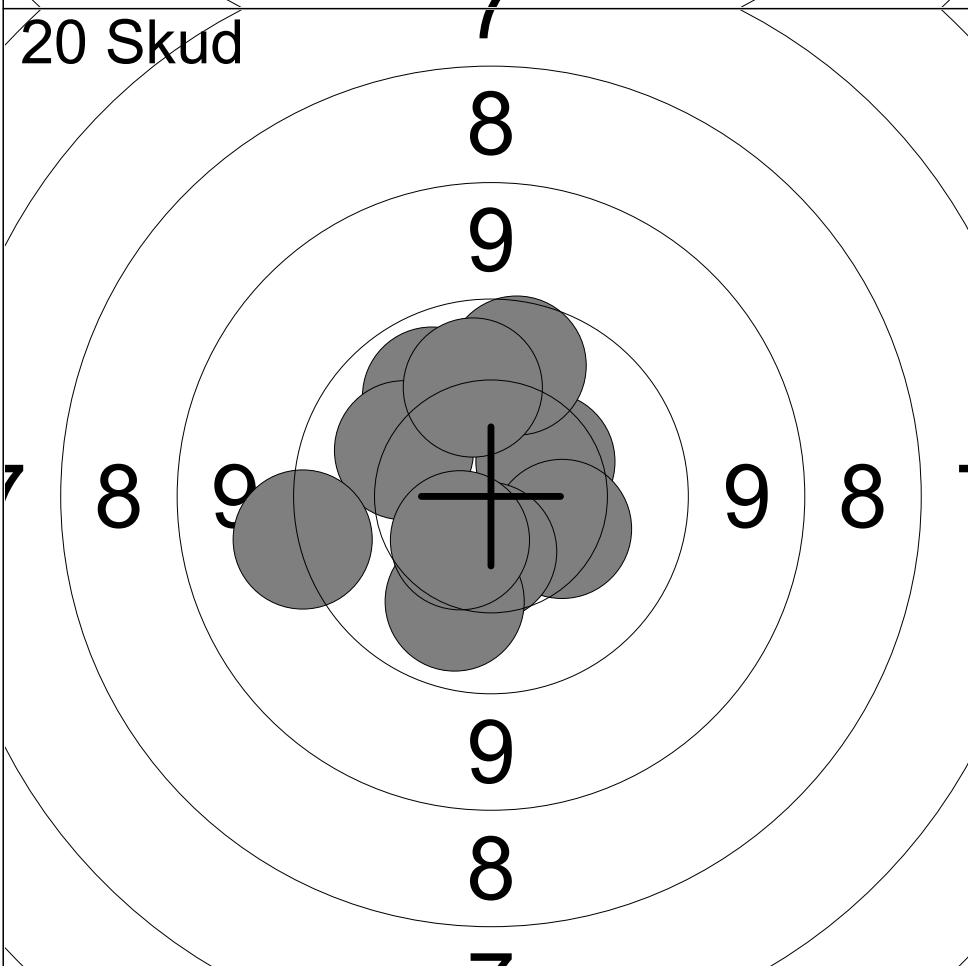

11:	10.0	↗
12:	10.4	↗
13:	10.3	↘
14:	10.5	↘
15:	9.9	↗
16:	10.2	↘
17:	9.4	←
18:	10.1	↘
19:	10.1	↗
20:	10.5	↘

Serie	98 (0x)
Total	192 (0x)

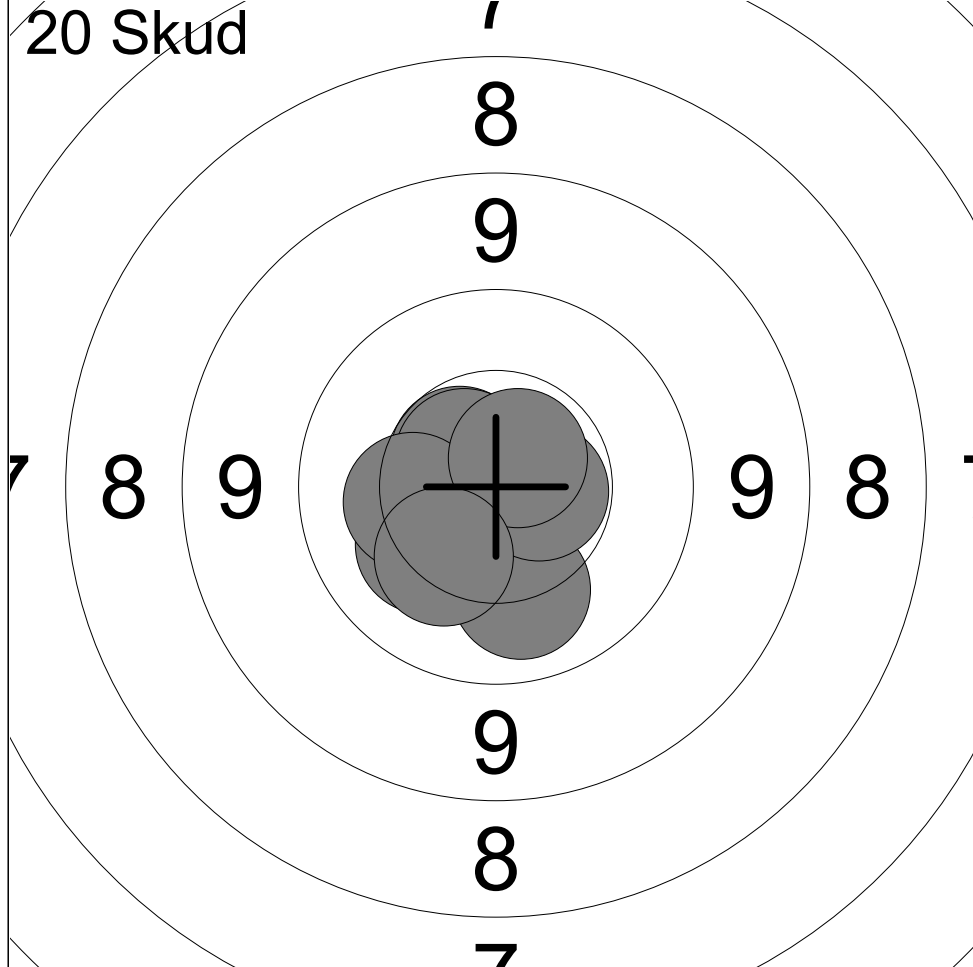

1:	10.6	↖
2:	10.5	←
3:	10.7x	→
4:	10.2	↖
5:	10.1	↓
6:	10.6x	↗
7:	10.3	←
8:	10.6x	→
9:	10.7x	↗
10:	10.3	↖

Serie	100 (4x)
Total	100 (4x)

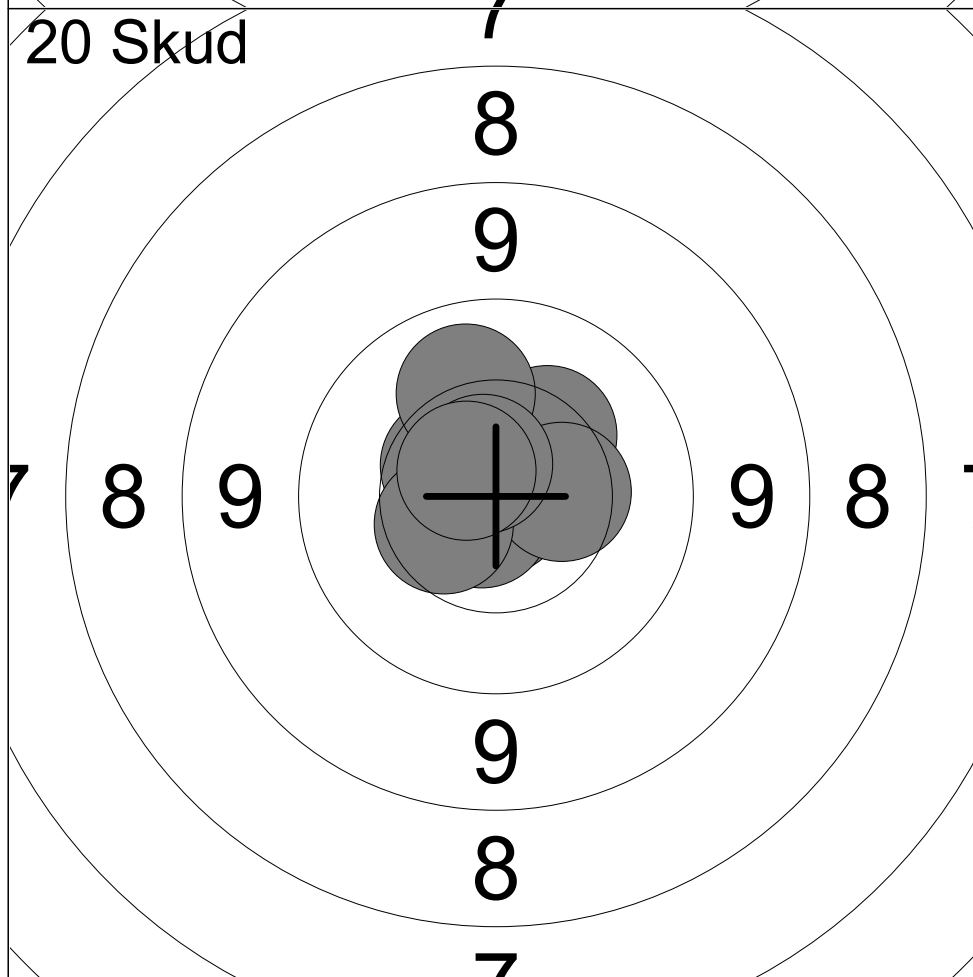

11:	10.3	↗
12:	10.7x	↖
13:	10.9x	↓
14:	10.5	↖
15:	10.7x	↖
16:	10.4	→
17:	10.5	↖
18:	10.1	↗
19:	10.7x	↗
20:	10.6x	↖

Serie	100 (5x)
Total	200 (9x)

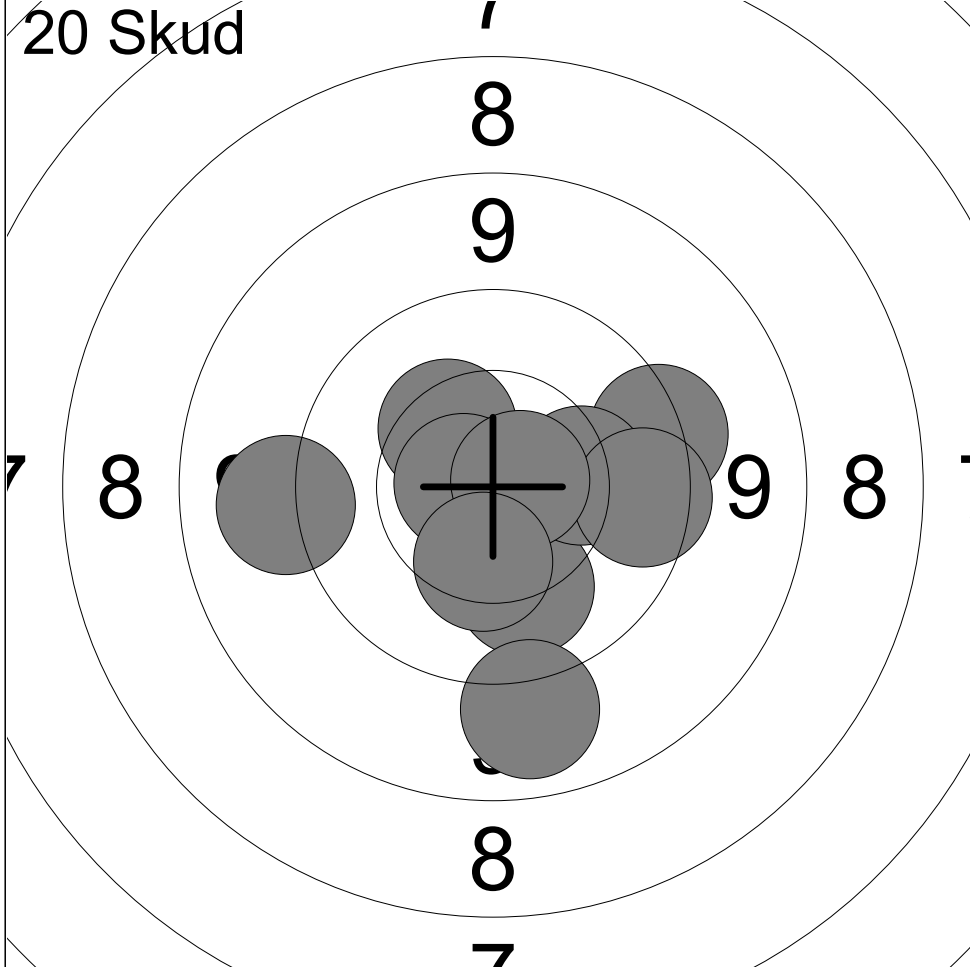

1:	9.6	→
2:	10.1	↓
3:	10.3	→
4:	10.4	↗
5:	9.3	←
6:	9.8	→
7:	10.7x	←
8:	9.1	↓
9:	10.7x	→
10:	10.4	↓

Serie	96 (2x)
Total	96 (2x)

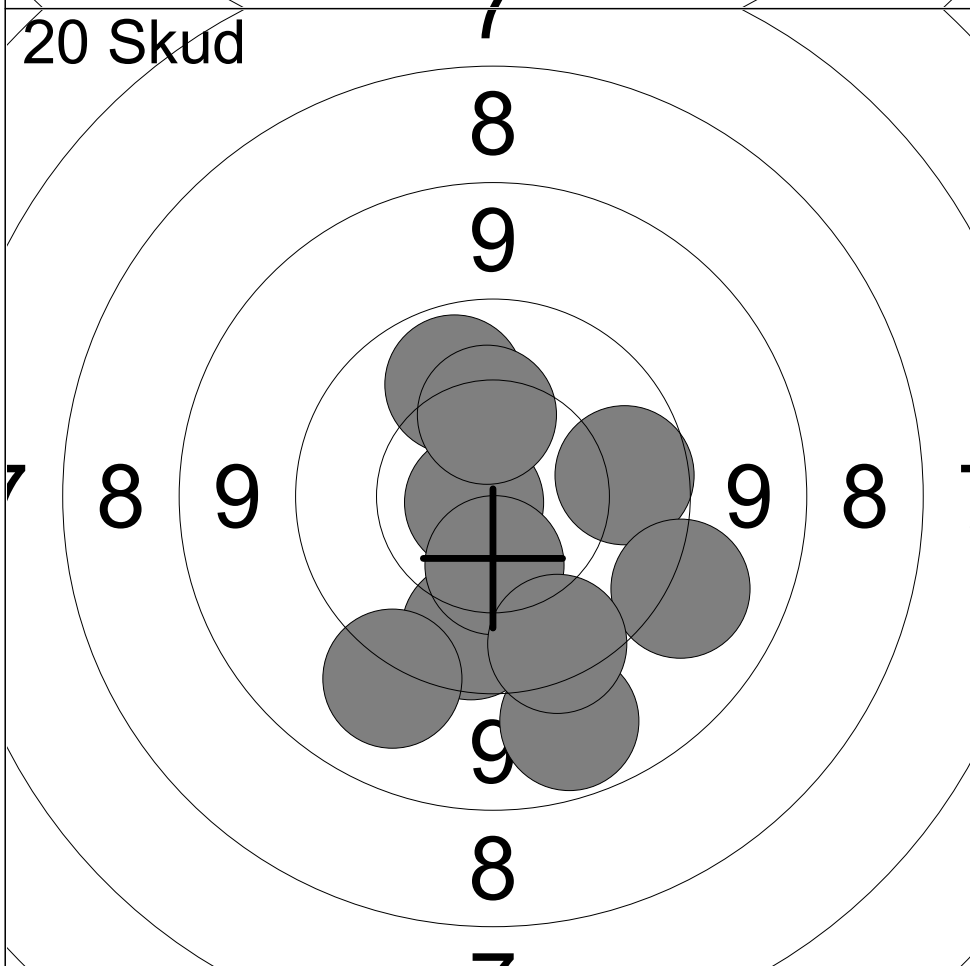

11:	9.9	↓
12:	10.8x	←
13:	10.4	↓
14:	9.3	↙
15:	9.9	→
16:	9.0	↓
17:	10.0	↗
18:	9.3	↘
19:	9.7	↓
20:	10.3	↑

Serie	94 (1x)
Total	190 (3x)

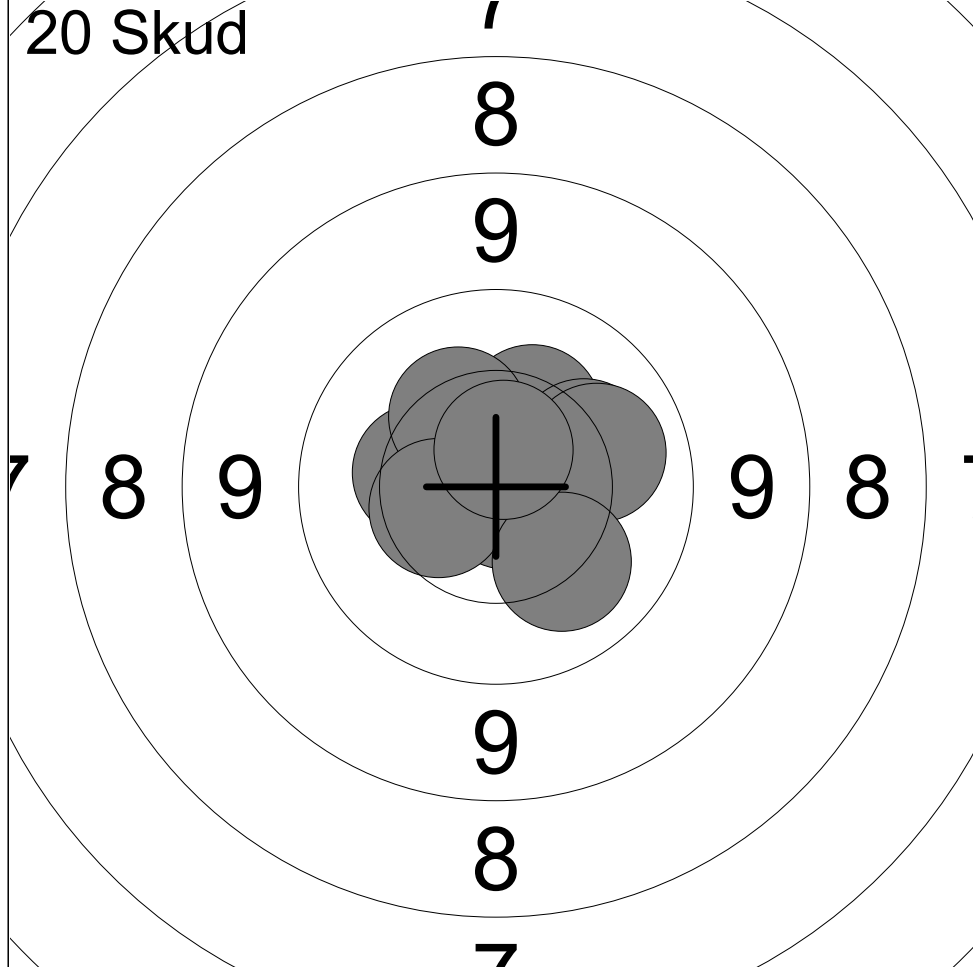

1:	10.6x	←
2:	10.8x	↘
3:	10.3	↗
4:	10.2	→
5:	10.4	←
6:	10.3	↗
7:	10.5	←
8:	10.1	→
9:	10.2	↘
10:	10.7x	↑

Serie	100 (3x)
Total	100 (3x)

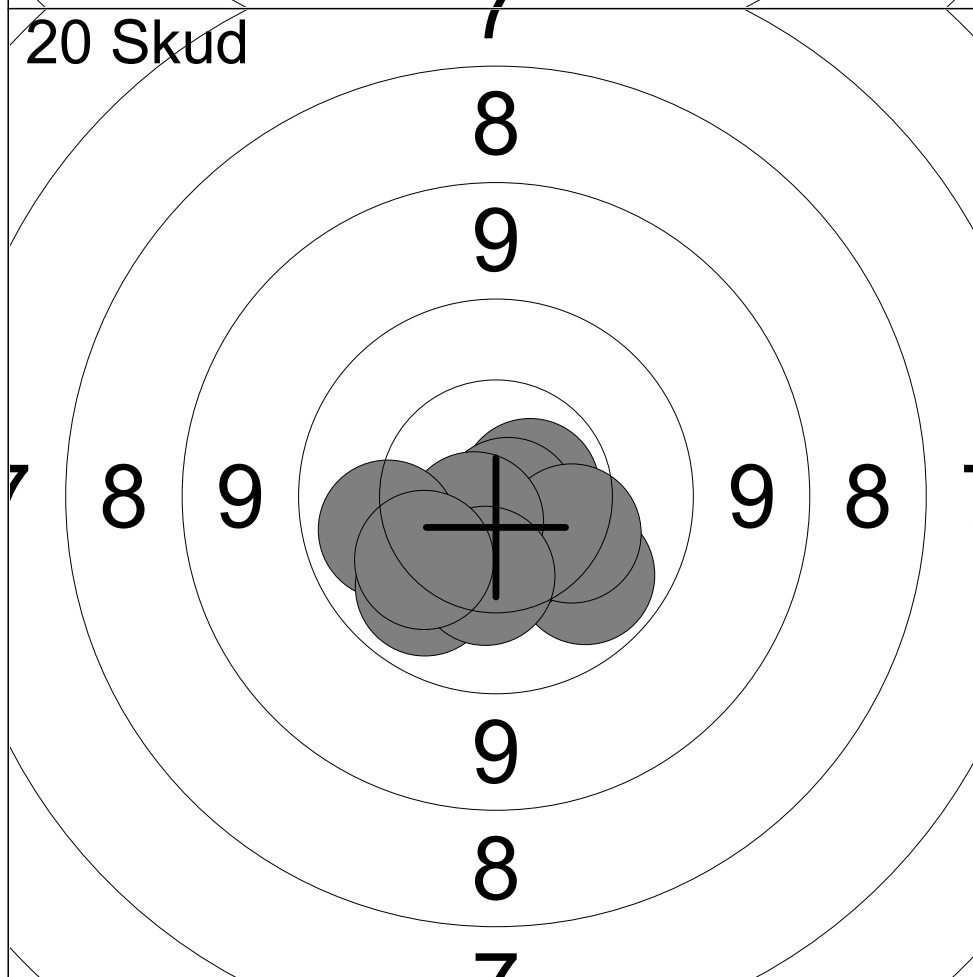

11:	10.7x	→
12:	10.0	↘
13:	10.5	↘
14:	10.8x	↘
15:	10.3	↘
16:	10.7x	↖
17:	10.1	←
18:	10.1	↖
19:	10.3	↘
20:	10.2	↖

Serie	100 (3x)
Total	200 (6x)

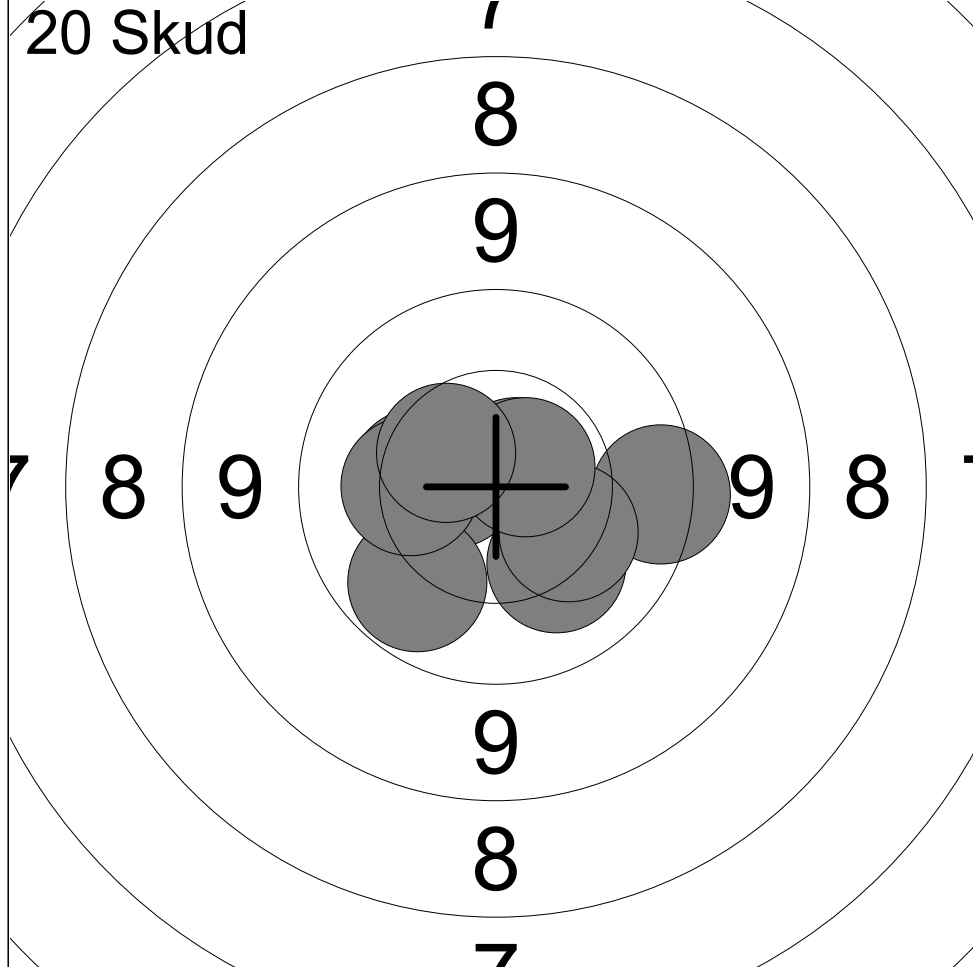

1:	10.3	←
2:	10.7x	↗
3:	9.6	→
4:	10.2	↘
5:	10.6x	←
6:	10.3	↘
7:	10.7x	↗
8:	10.0	↙
9:	10.3	←
10:	10.5	↖

Serie	99 (3x)
Total	99 (3x)

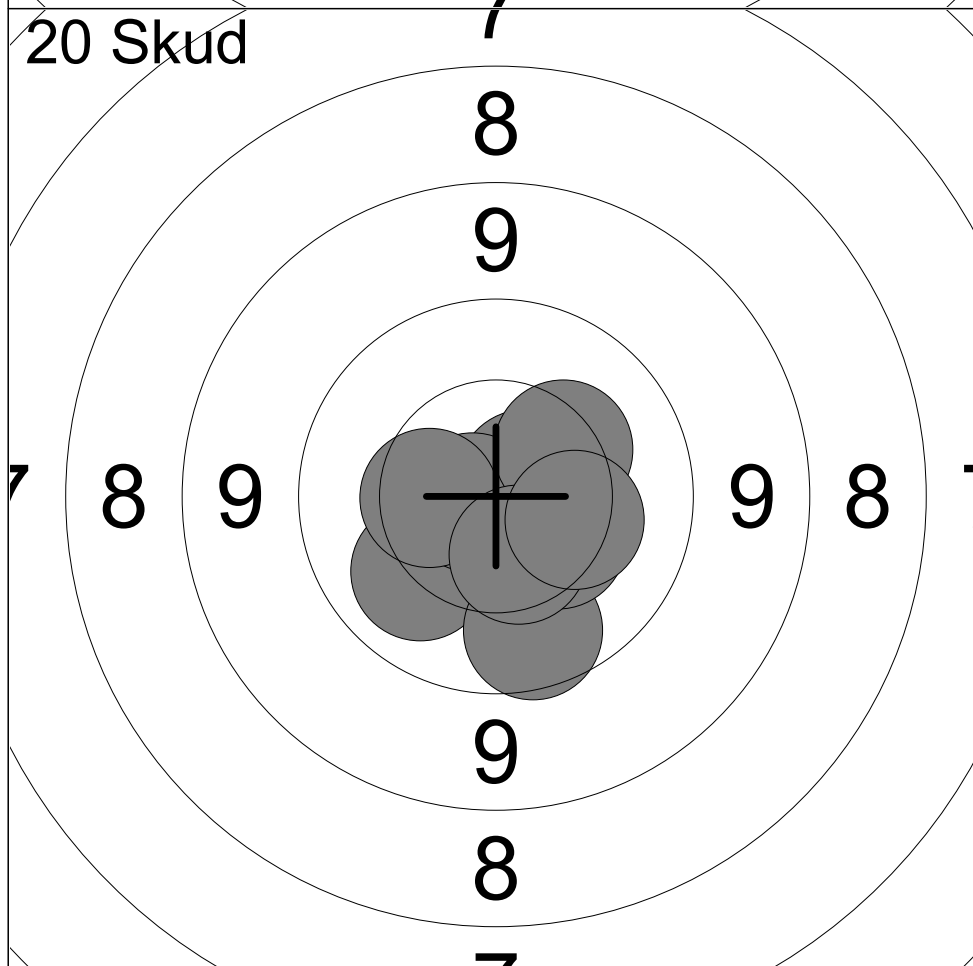

11:	10.7x	↗
12:	10.1	↙
13:	10.5	→
14:	10.8x	←
15:	9.9	↘
16:	10.4	↘
17:	10.4	←
18:	10.3	↗
19:	10.5	↘
20:	10.3	→

Serie	99 (2x)
Total	198 (5x)

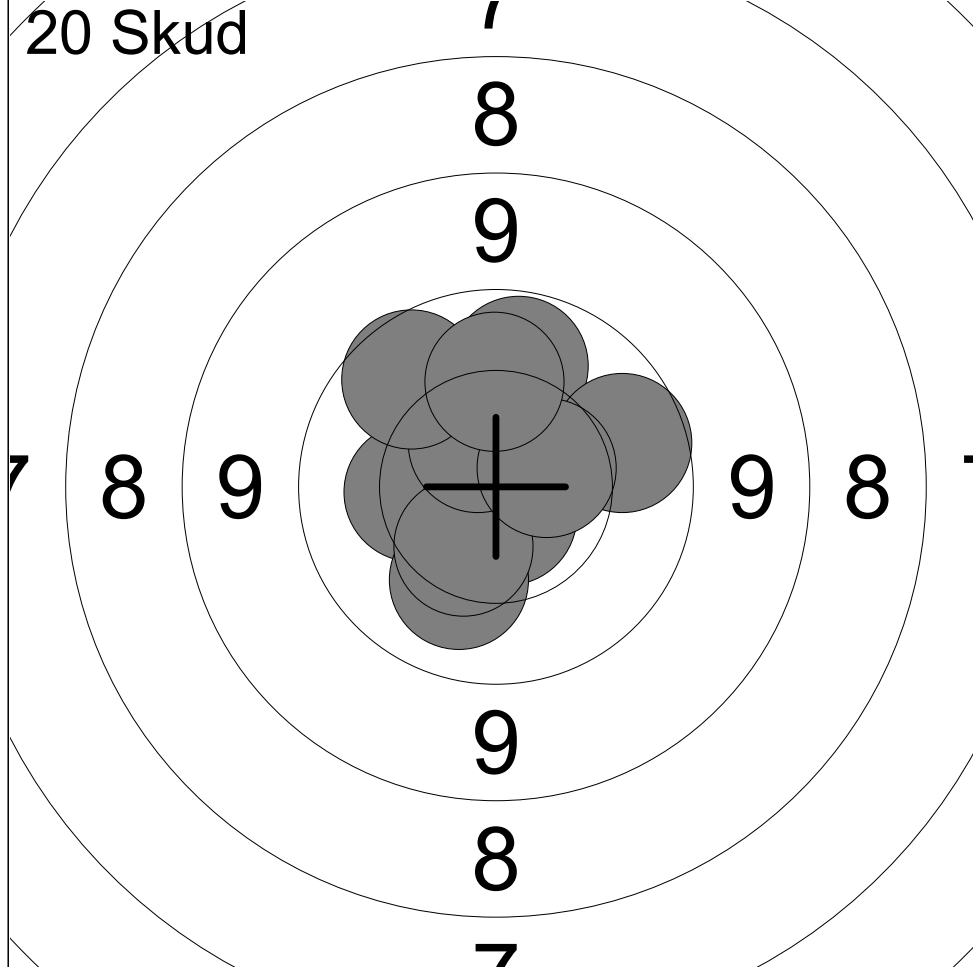

1:	10.0	↑
2:	10.7x	↓
3:	10.3	←
4:	9.9	→
5:	10.2	↓
6:	10.4	↙
7:	10.6	↑
8:	9.9	↑
9:	10.5	→
10:	10.1	↑

Serie	98 (1x)
Total	98 (1x)

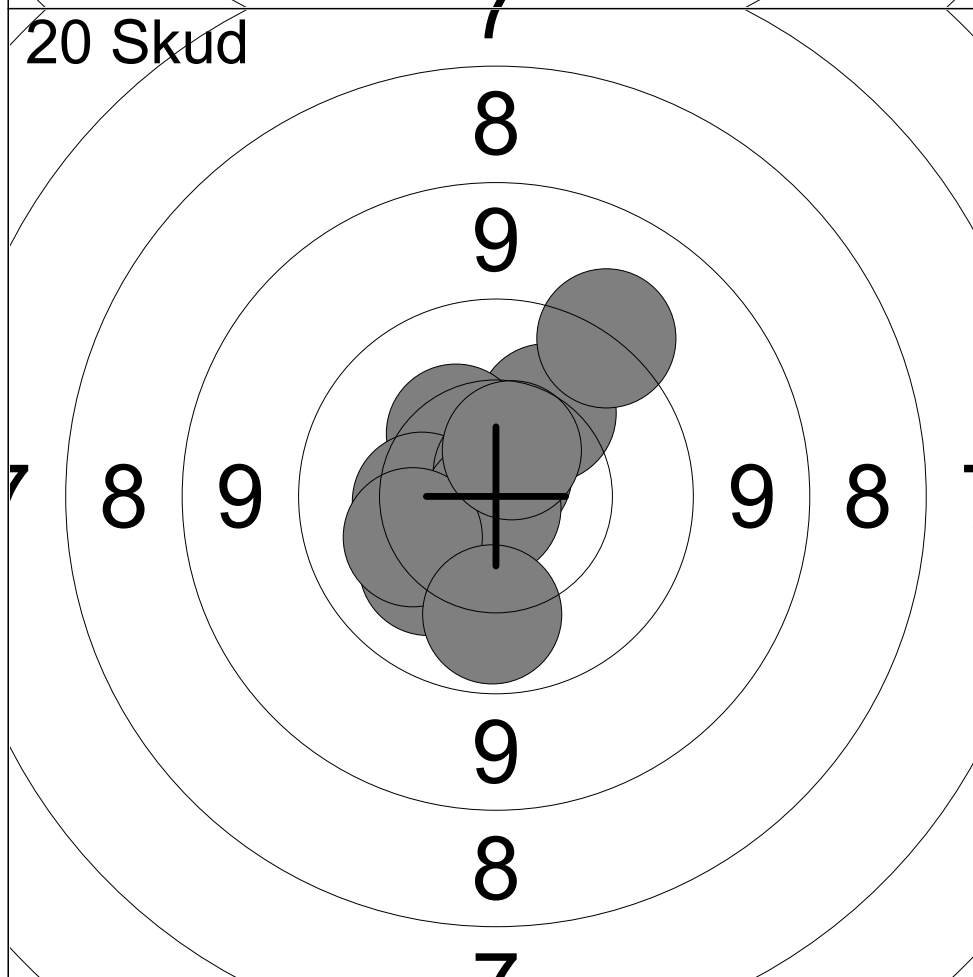

11:	10.2	↗
12:	10.2	↖
13:	10.4	↑
14:	10.4	←
15:	10.8x	↑
16:	9.4	↗
17:	10.9x	↓
18:	10.2	↖
19:	10.6	↑
20:	10.0	↓

Serie	99 (2x)
Total	197 (3x)

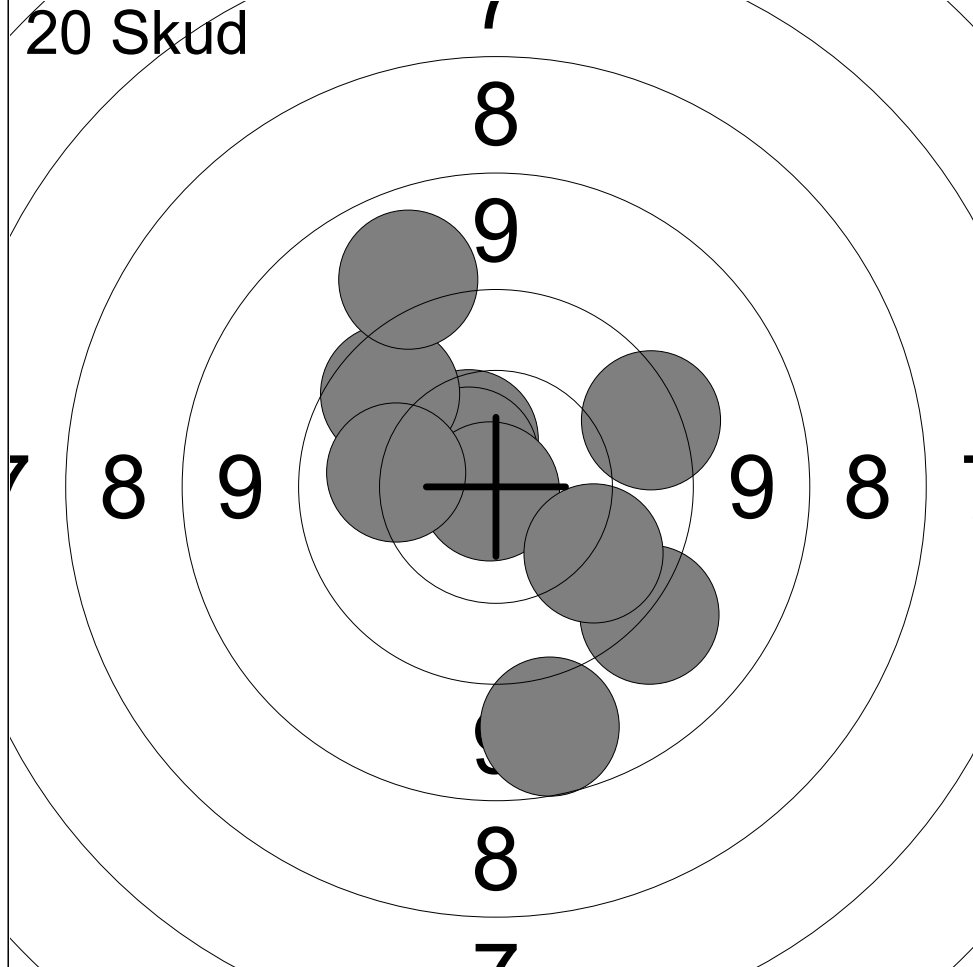

1:	10.5	↗
2:	9.6	↘
3:	10.6x	↗
4:	10.9x	↖
5:	9.8	↗
6:	9.1	↗
7:	10.2	↖
8:	8.9	↘
9:	9.3	↘
10:	10.0	↘

Serie	94 (2x)
Total	94 (2x)

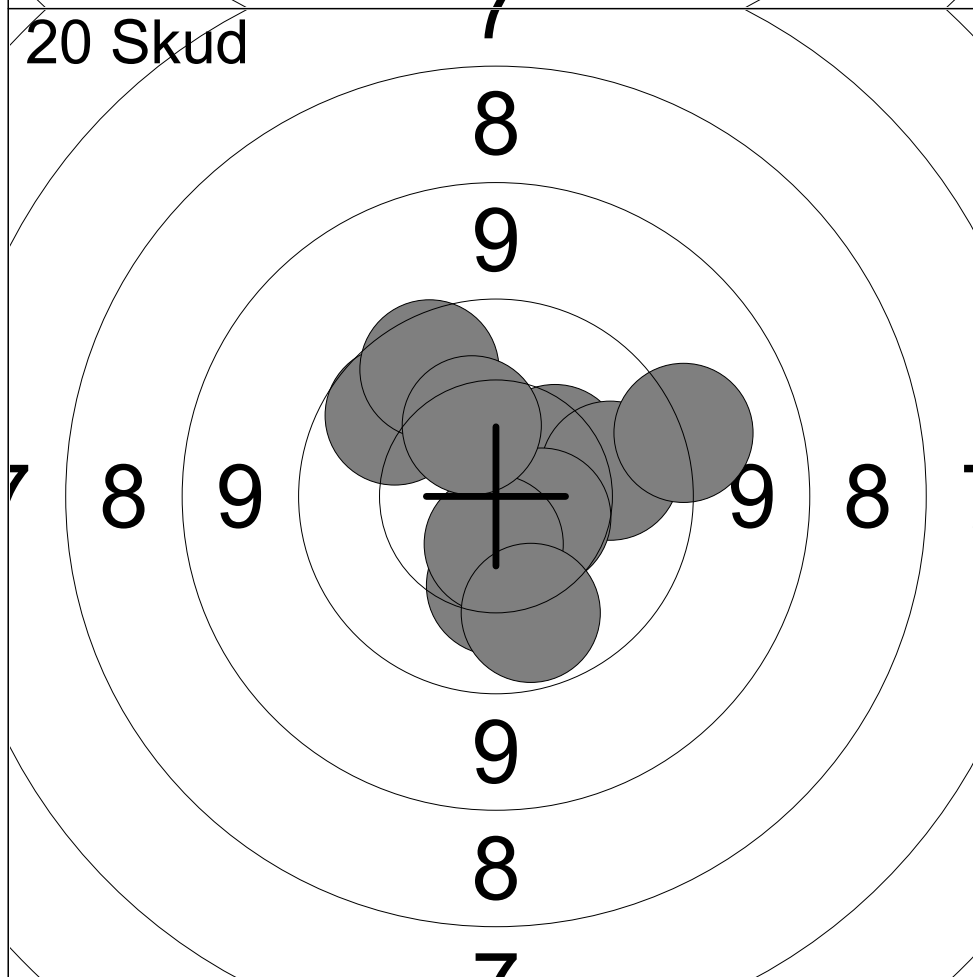

11:	10.4	↗
12:	10.0	↘
13:	9.9	↗
14:	10.6	↘
15:	10.3	↘
16:	9.8	↗
17:	9.3	↘
18:	10.6	↘
19:	10.4	↗
20:	10.0	↘

Serie	97 (0x)
Total	191 (2x)

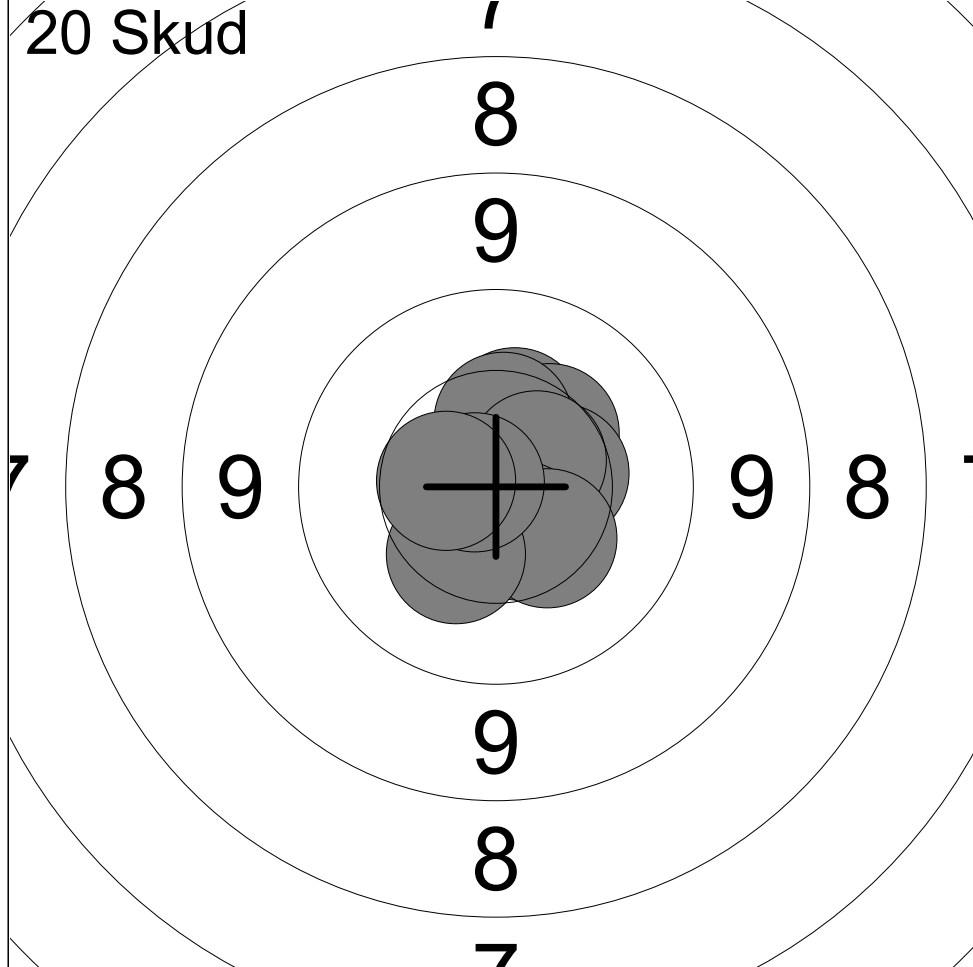

1:	10.4	↗
2:	10.4	↘
3:	10.4	↑
4:	10.4	→
5:	10.6	↘
6:	10.6	↘
7:	10.4	↘
8:	10.3	↘
9:	10.8x	←
10:	10.6	←

Serie	100 (1x)
Total	100 (1x)

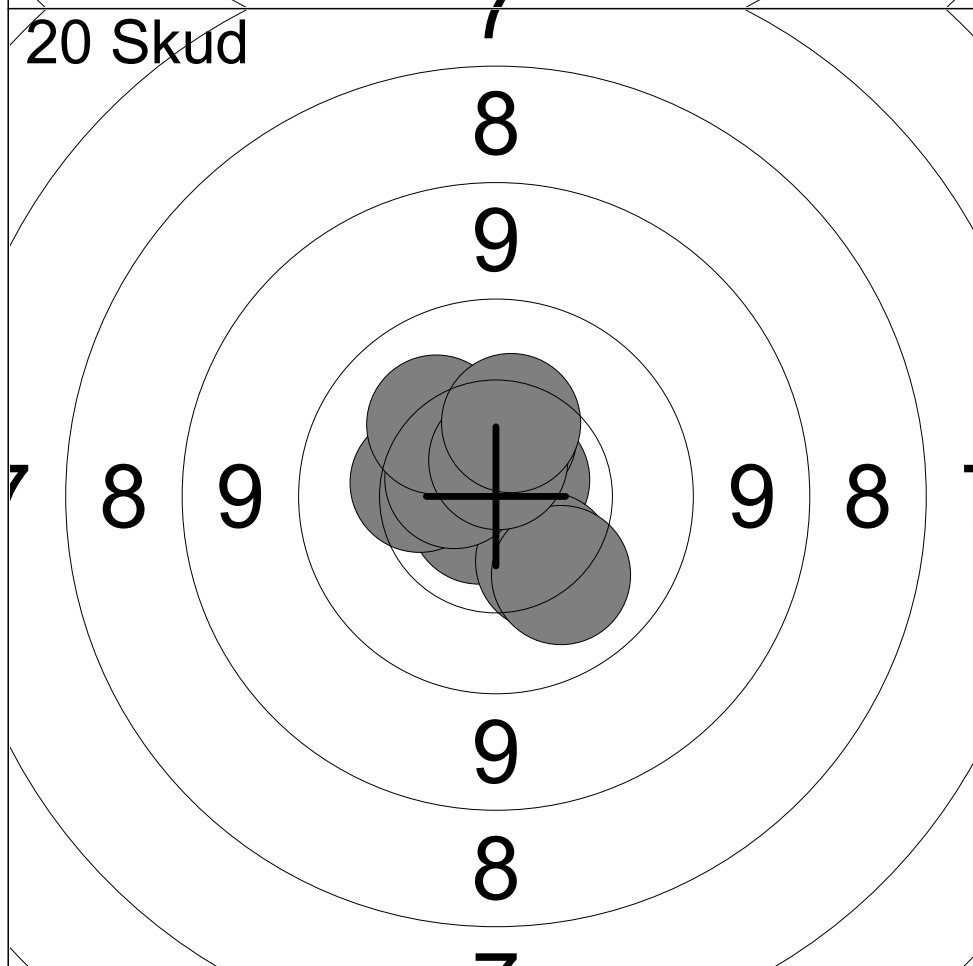

11:	10.7x	↘
12:	10.5	↑
13:	10.8x	↘
14:	10.3	↘
15:	10.3	←
16:	10.1	↘
17:	10.6x	↗
18:	10.2	↗
19:	10.7x	↑
20:	10.4	↑

Serie	100 (4x)
Total	200 (5x)

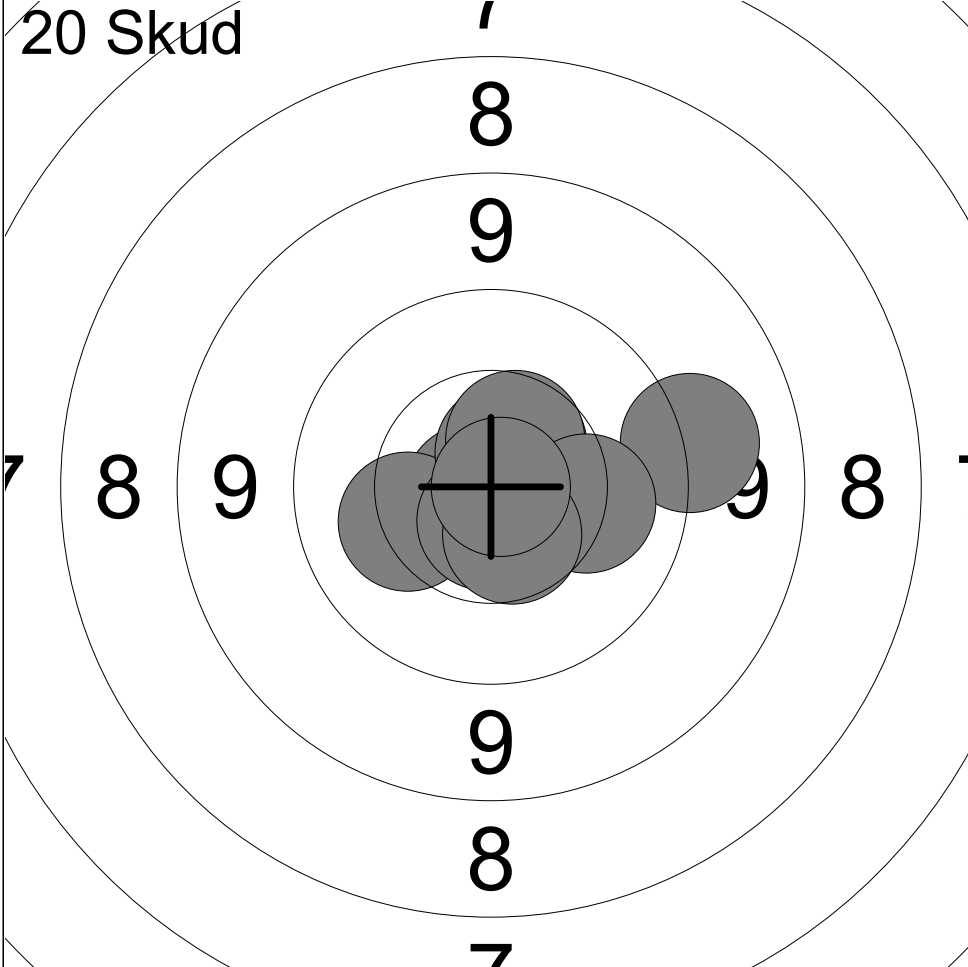

1:	10.8x	←
2:	10.2	←
3:	10.7x	↗
4:	10.7x	↘
5:	9.3	→
6:	10.6	↗
7:	10.5	↗
8:	10.2	→
9:	10.5	↘
10:	10.9x	→

Serie	99 (4x)
Total	99 (4x)

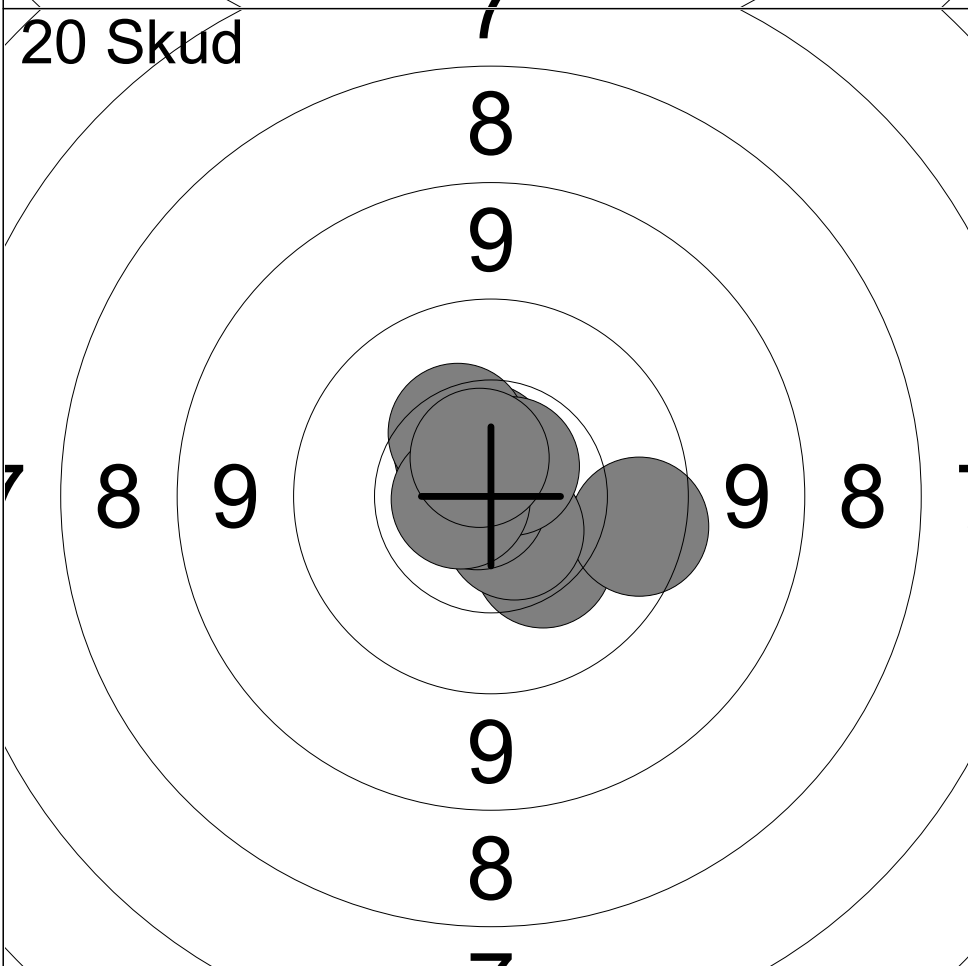

11:	10.6x	↗
12:	10.5	↗
13:	10.4	↗
14:	10.3	↘
15:	9.8	→
16:	10.6x	↘
17:	10.8x	←
18:	10.7x	↗
19:	10.7x	←
20:	10.6x	↗

Serie	99 (6x)
Total	198 (10x)

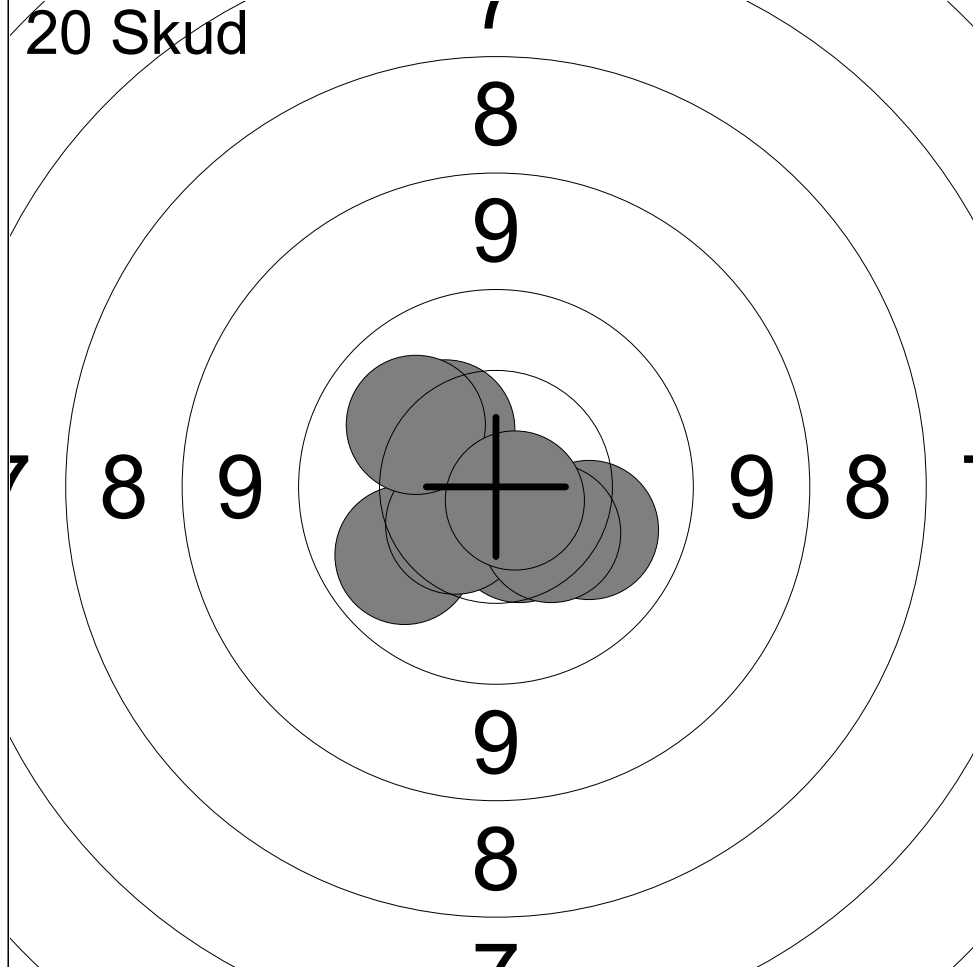

1:	10.5	↘
2:	10.8x	↙
3:	10.3	↗
4:	10.6x	↙
5:	10.1	↙
6:	10.1	↘
7:	10.5	↙
8:	10.2	↗
9:	10.4	↘
10:	10.8x	↘

Serie	100 (3x)
Total	100 (3x)

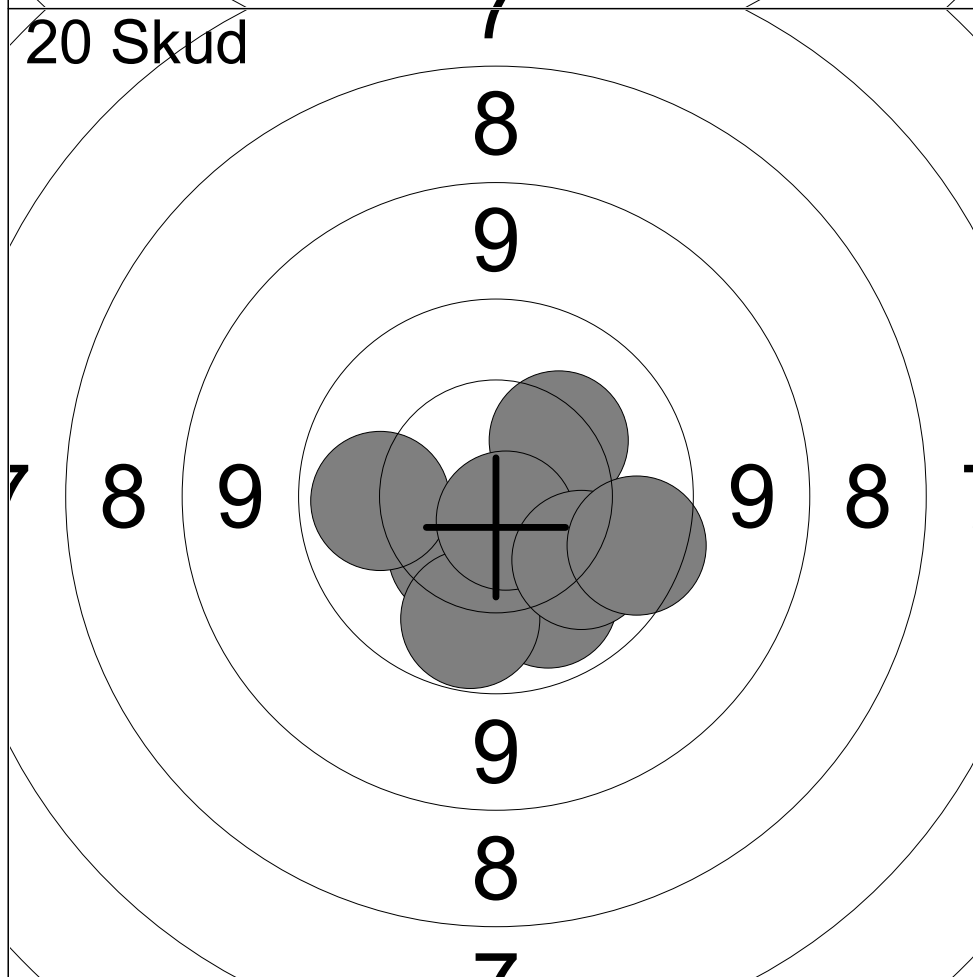

11:	10.4	↘
12:	10.3	↘
13:	10.3	↗
14:	10.4	↙
15:	10.0	←
16:	10.1	↘
17:	10.0	↘
18:	10.7x	↘
19:	10.1	↘
20:	9.8	↘

Serie	99 (1x)
Total	199 (4x)

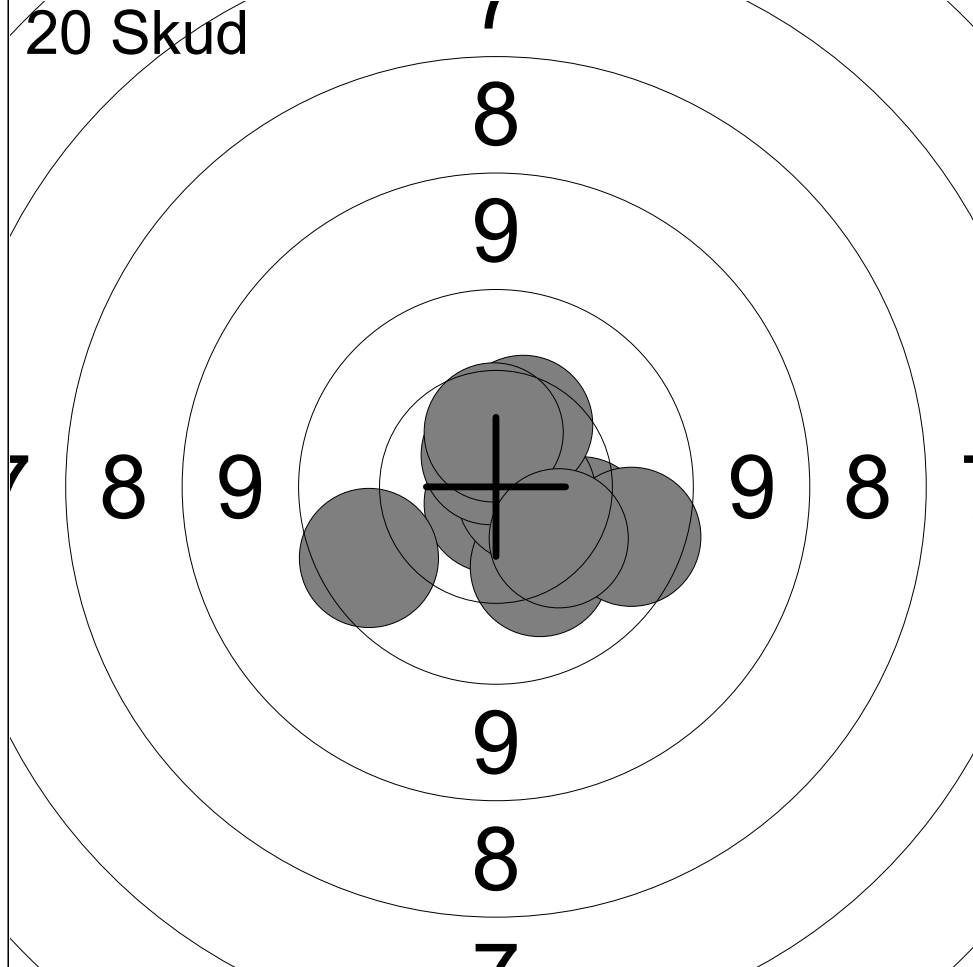

1:	10.8x	↓
2:	10.2	↘
3:	10.2	↘
4:	9.8	↘
5:	10.7x	→
6:	9.8	↙
7:	10.7x	↑
8:	10.4	↗
9:	10.5	↑
10:	10.3	↘

Serie	98 (3x)
Total	98 (3x)

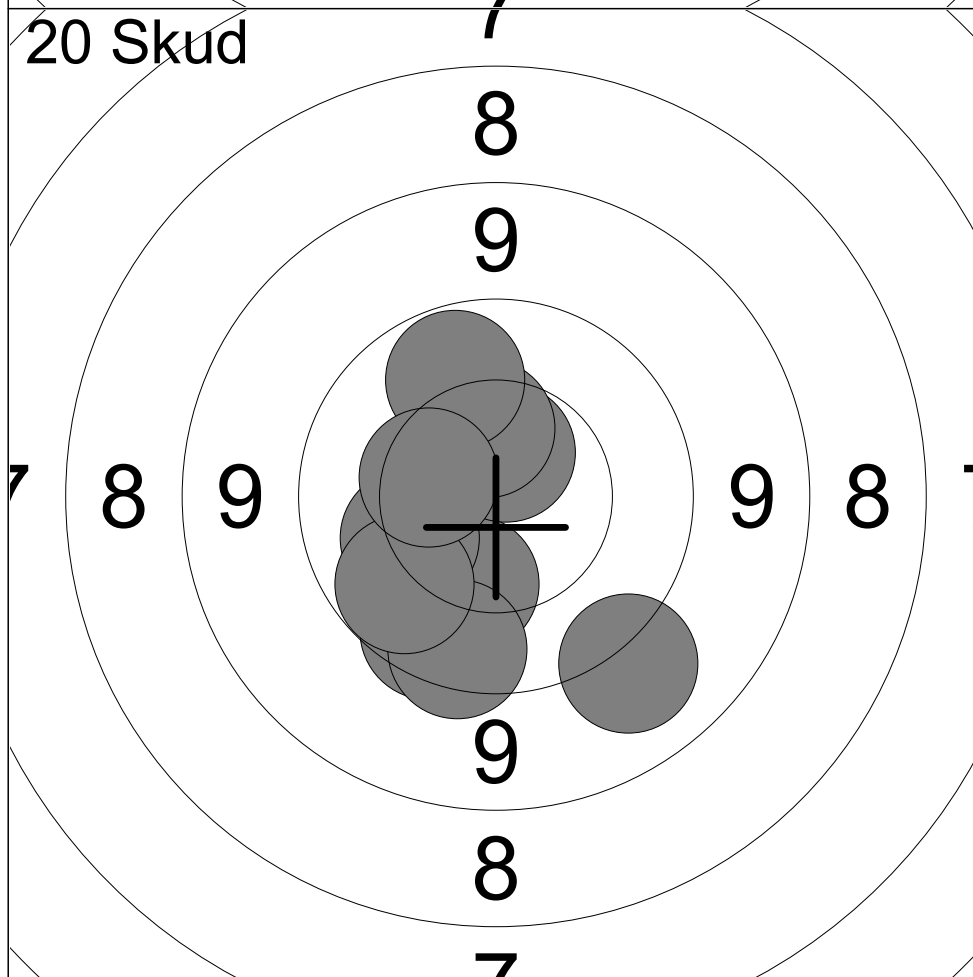

11:	9.8	↙
12:	10.2	↙
13:	10.6x	↑
14:	10.4	↑
15:	9.7	↘
16:	10.2	↙
17:	10.0	↑
18:	9.2	↘
19:	10.0	↙
20:	10.4	↙

Serie	97 (1x)
Total	195 (4x)

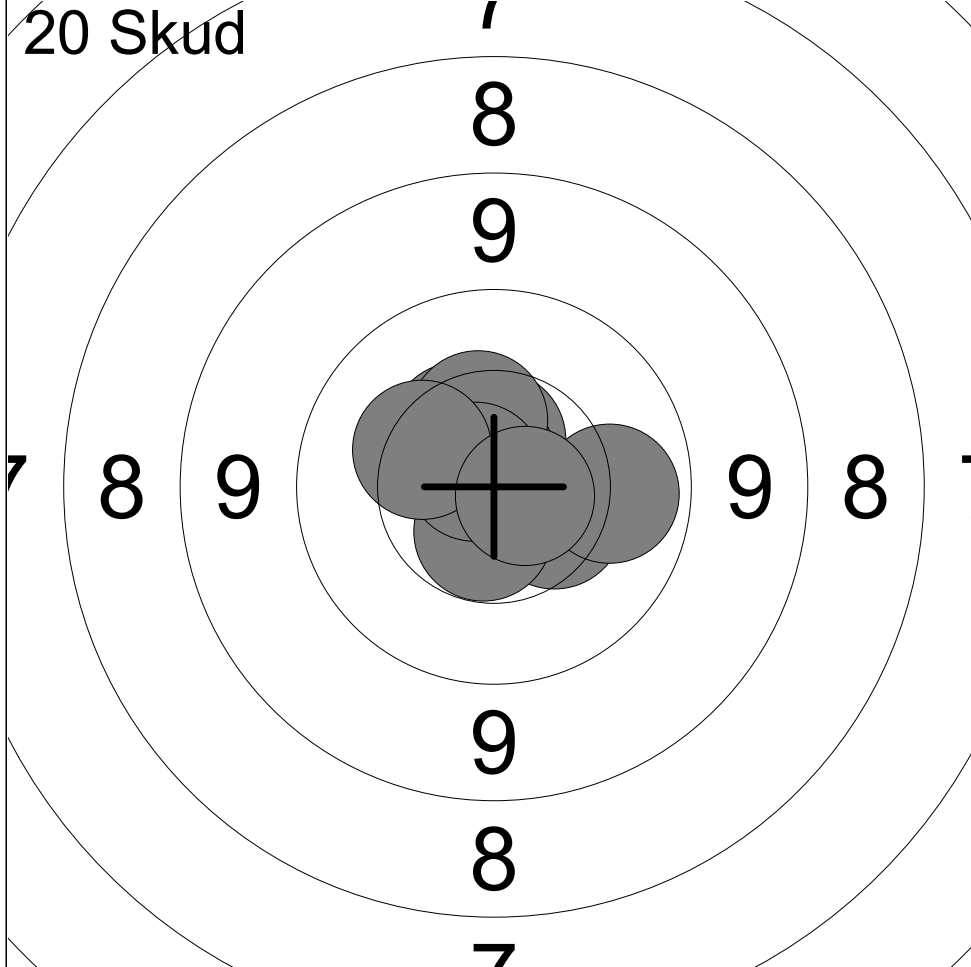

1:	10.4	↘
2:	10.6	↑
3:	10.4	↗
4:	10.6x	↘
5:	10.7x	↑
6:	10.0	→
7:	10.4	↑
8:	10.8x	↗
9:	10.3	↗
10:	10.7x	↘

Serie	100 (4x)
Total	100 (4x)

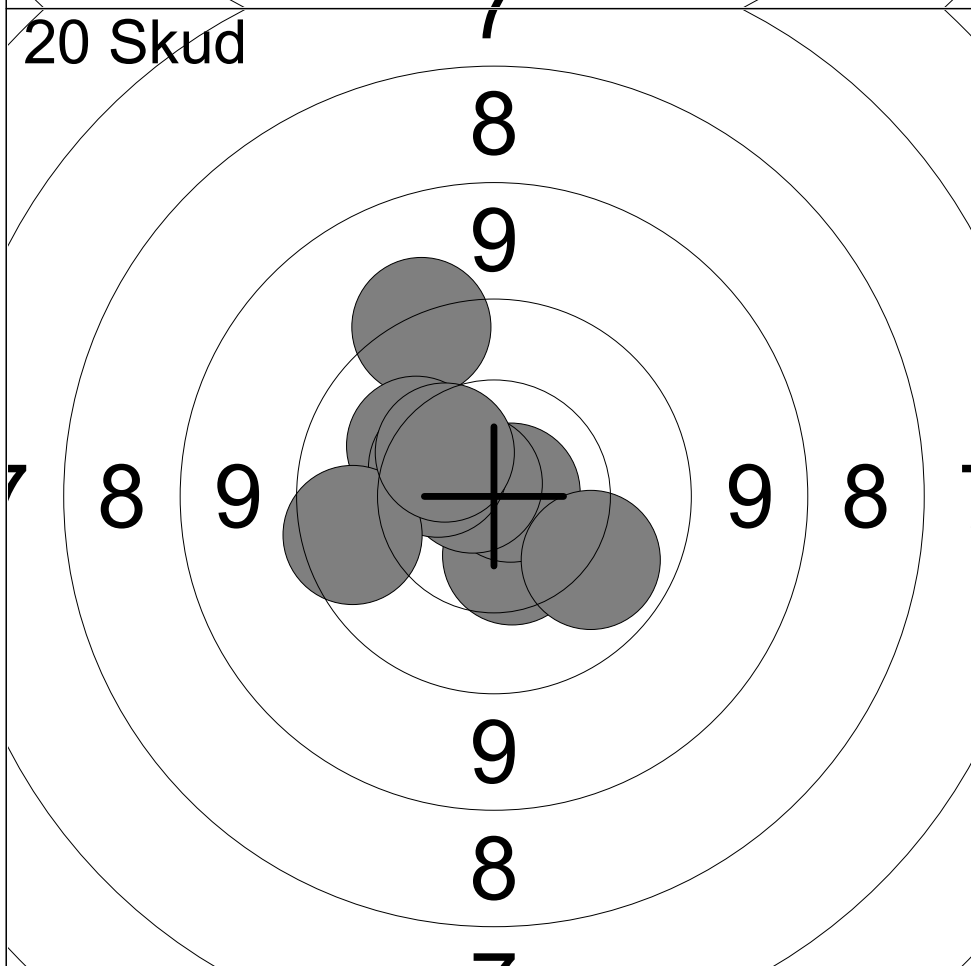

11:	9.5	↗
12:	10.7x	↘
13:	10.5	↘
14:	10.8x	→
15:	10.0	↘
16:	10.8x	↗
17:	10.2	↗
18:	10.5	↗
19:	9.8	←
20:	10.4	↗

Serie	98 (3x)
Total	198 (7x)

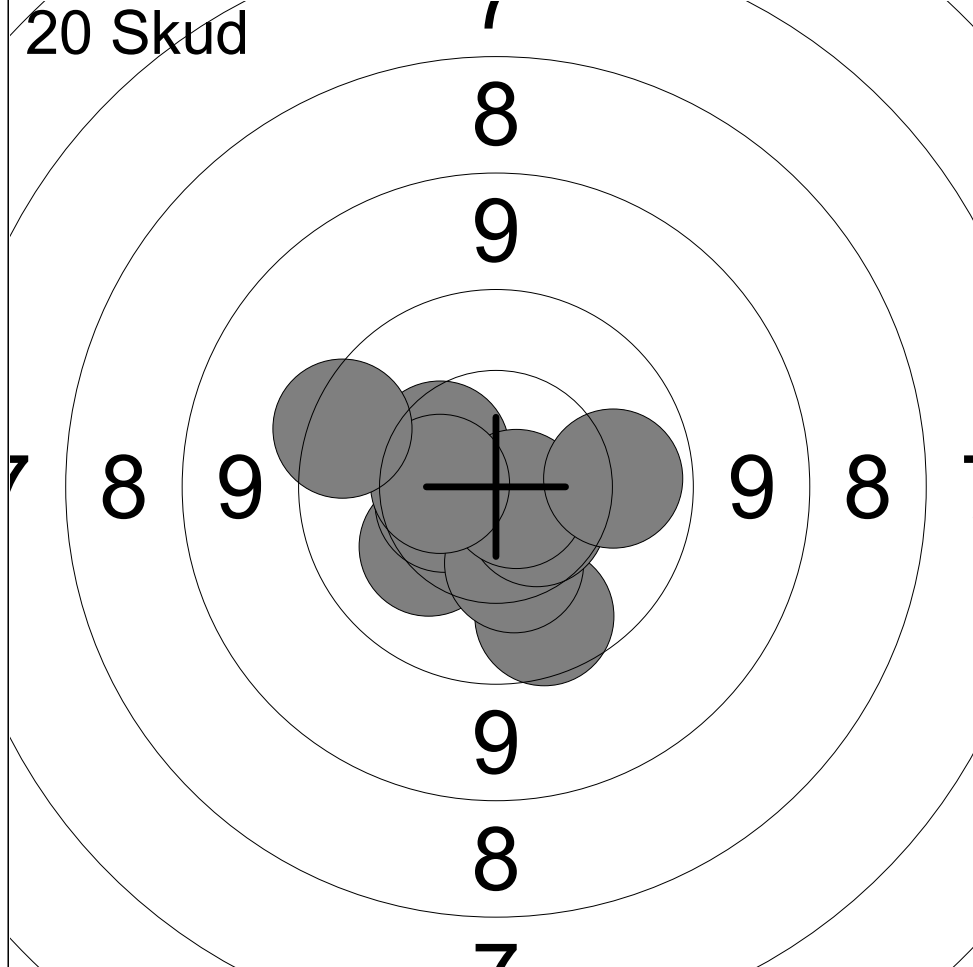

1:	10.2	↙
2:	9.9	↓
3:	10.5	↖
4:	10.4	↗
5:	10.3	↓
6:	10.6	↘
7:	10.8x	↘
8:	10.5	←
9:	10.0	→
10:	9.6	↖

Serie	98 (1x)
Total	98 (1x)

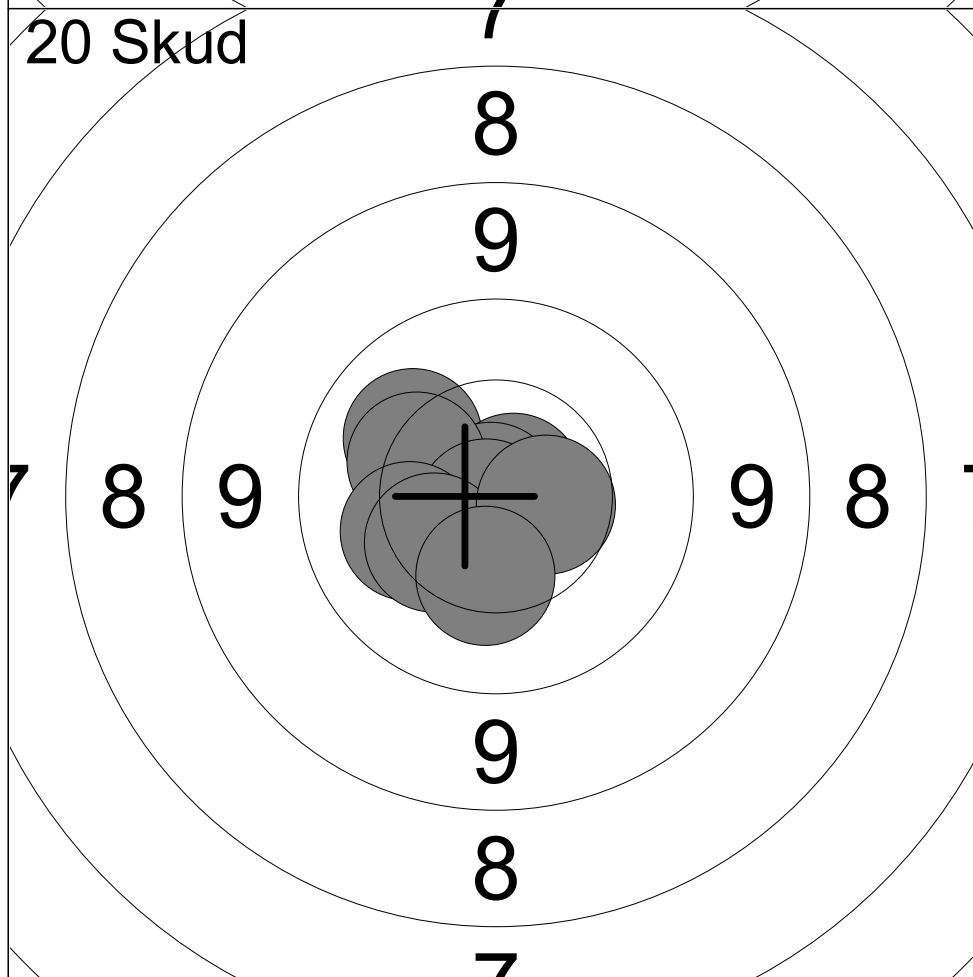

11:	10.2	↖
12:	10.8x	↗
13:	10.6	←
14:	10.9x	↗
15:	10.3	↖
16:	10.8x	↘
17:	10.2	←
18:	10.3	↖
19:	10.6	→
20:	10.3	↓

Serie	100 (3x)
Total	198 (4x)

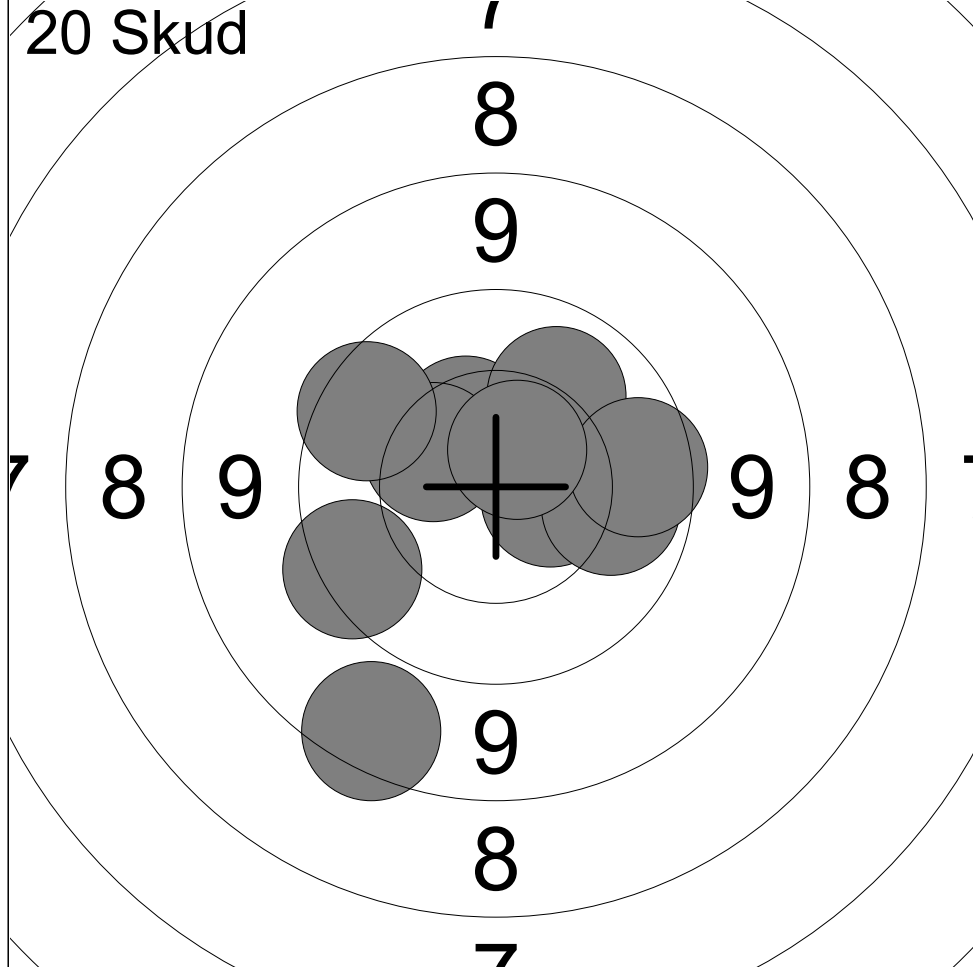

1:	10.4	↗
2:	10.5	→
3:	10.0	→
4:	10.1	↗
5:	10.4	↖
6:	9.8	→
7:	9.8	↖
8:	10.6x	↗
9:	9.6	↙
10:	8.7	↘

Serie	95 (1x)
Total	95 (1x)

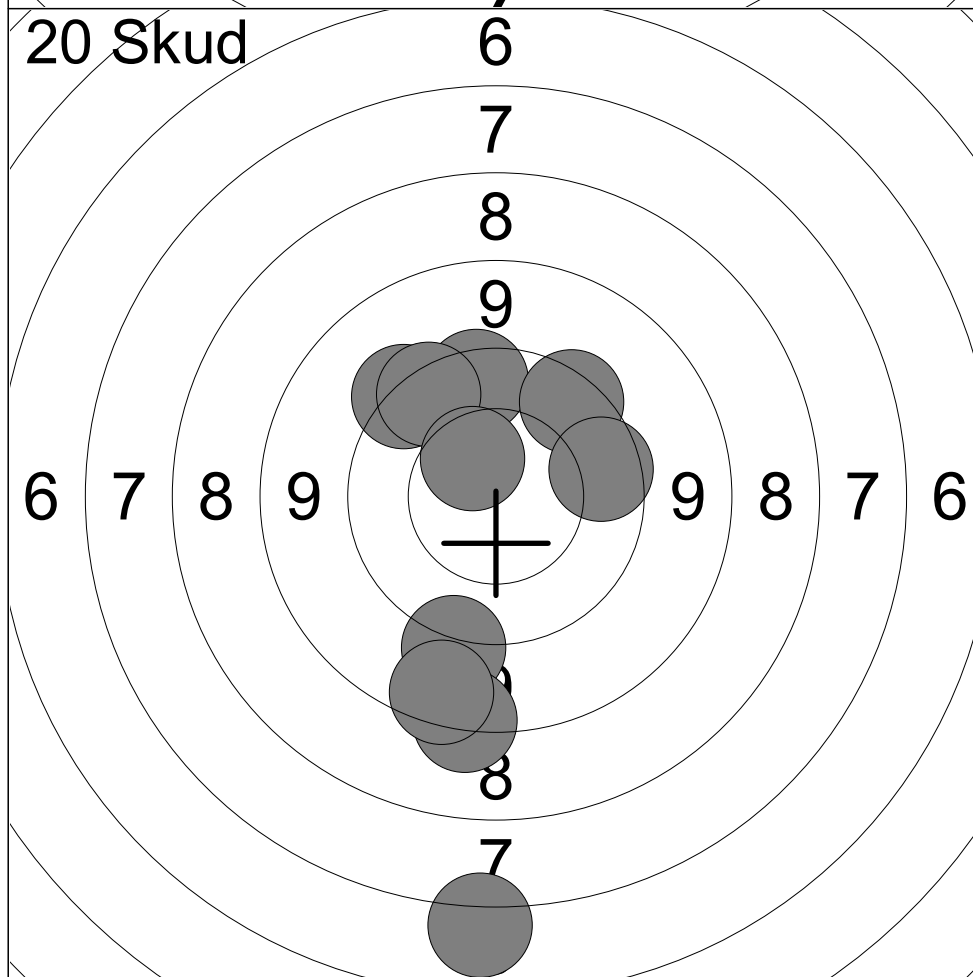

11:	9.3	↘
12:	9.5	↖
13:	8.5	↘
14:	6.1	↘
15:	9.7	↗
16:	9.7	↗
17:	8.7	↘
18:	9.6	↗
19:	10.5	↗
20:	9.8	→

Serie	86 (0x)
Total	181 (1x)

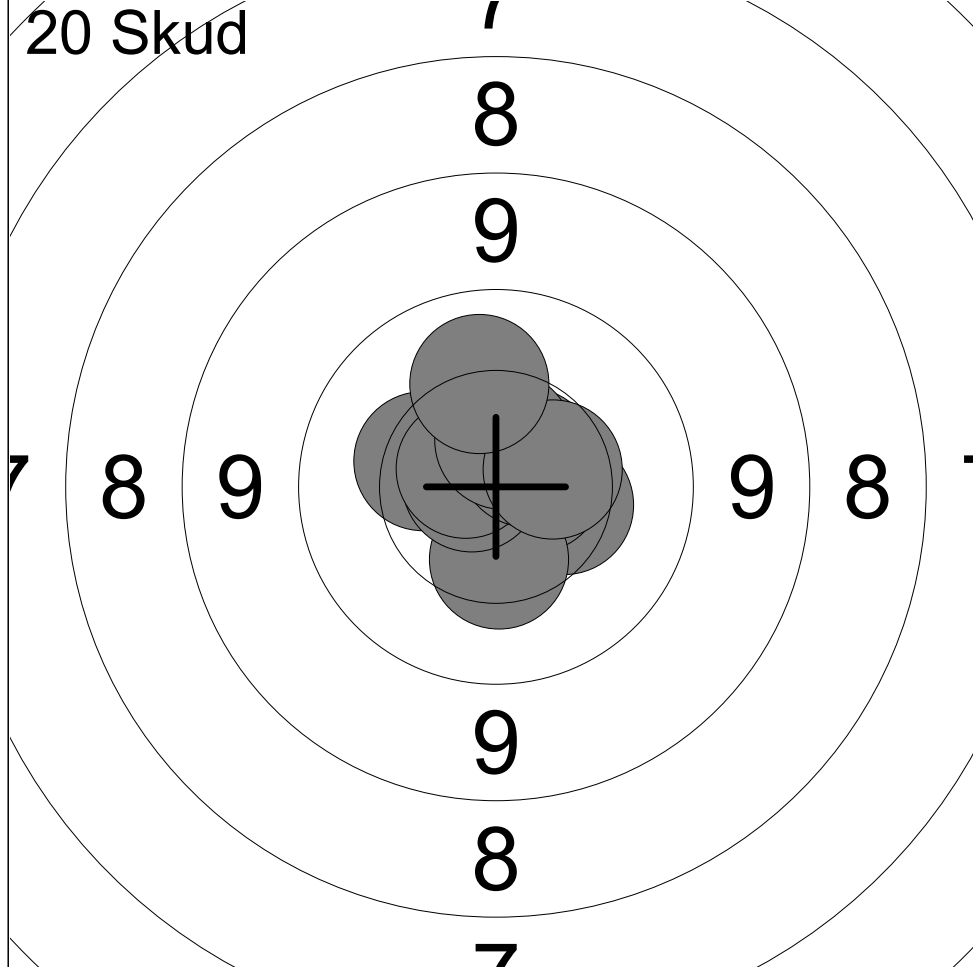

1:	10.4	→
2:	10.3	↖
3:	10.7x	→
4:	10.4	↓
5:	10.8x	↖
6:	10.7x	↖
7:	10.6x	↗
8:	10.6	↑
9:	10.5	→
10:	10.1	↑

Serie	100 (4x)
Total	100 (4x)

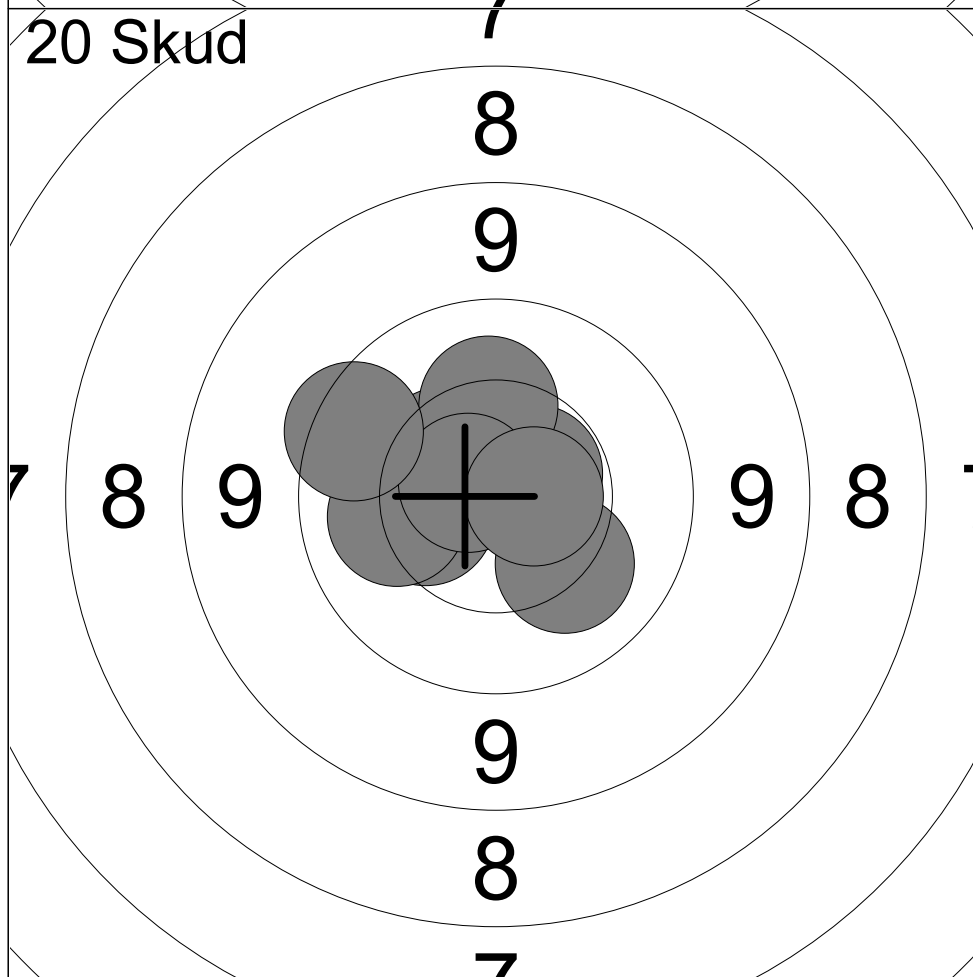

11:	10.6x	↗
12:	10.2	↘
13:	10.4	←
14:	10.4	↖
15:	10.3	←
16:	10.2	↑
17:	10.2	←
18:	10.7x	↖
19:	9.7	↖
20:	10.7x	→

Serie	99 (3x)
Total	199 (7x)

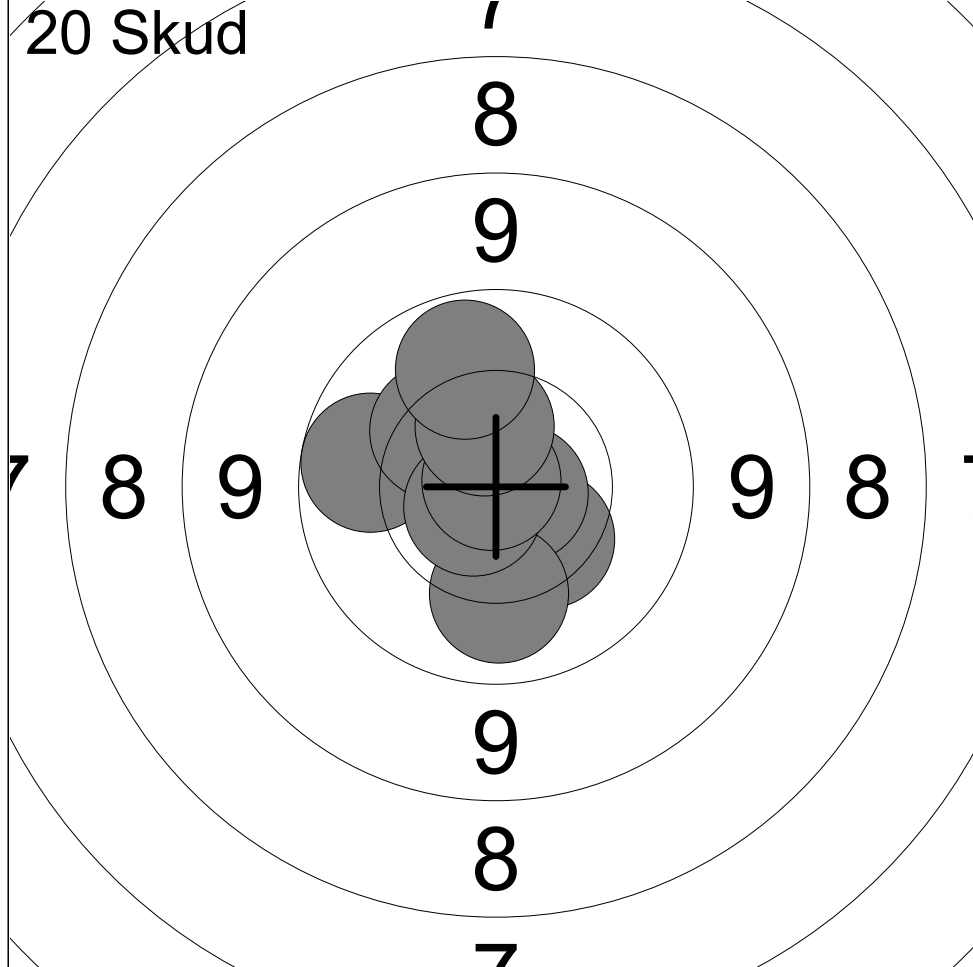

1:	10.0	←
2:	10.4	↘
3:	10.3	↗
4:	10.7x	↘
5:	10.8x	→
6:	10.1	↓
7:	10.7x	↙
8:	10.9x	↗
9:	10.5	↑
10:	10.0	↑

Serie	100 (4x)
Total	100 (4x)

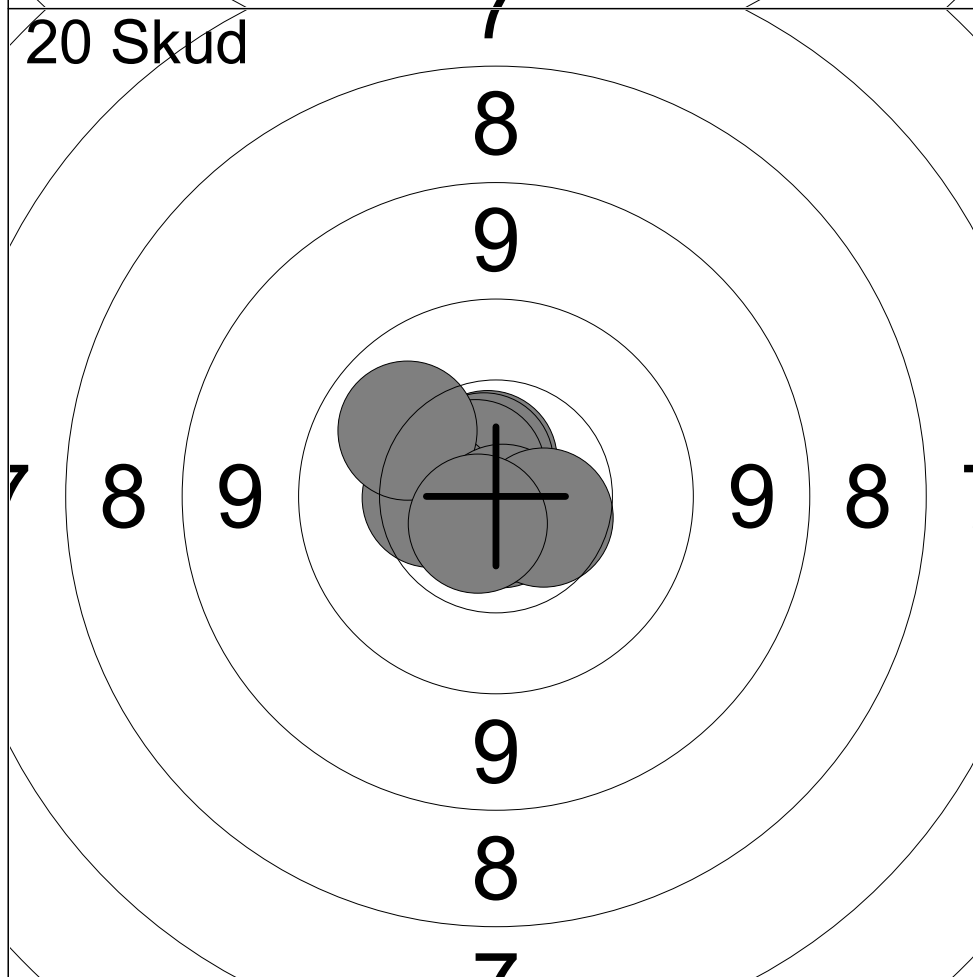

11:	10.7x	↑
12:	10.7x	↑
13:	10.7x	←
14:	10.8x	↘
15:	10.7x	↗
16:	10.4	←
17:	10.1	↗
18:	10.8x	↘
19:	10.5	↘
20:	10.7x	↘

Serie	100 (7x)
Total	200 (11x)

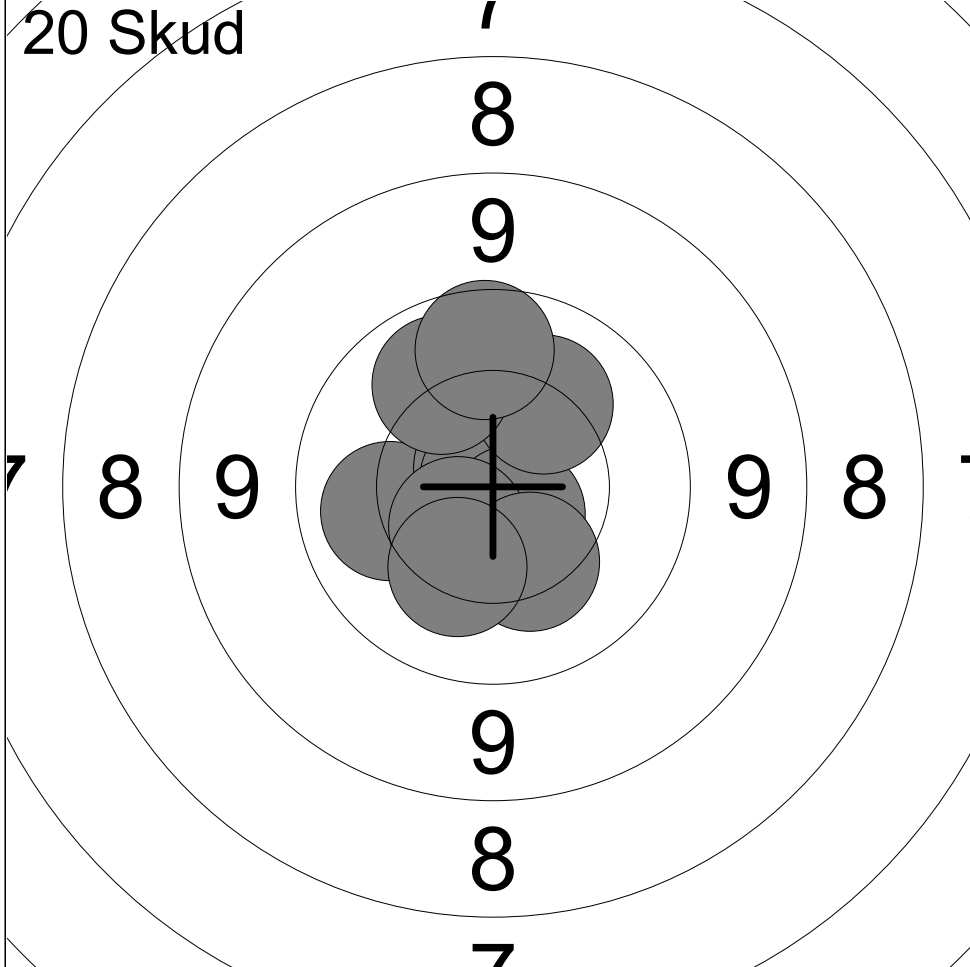

1:	10.1	←
2:	10.8x	↗
3:	10.9x	↗
4:	10.7x	↘
5:	10.5	↙
6:	10.3	↘
7:	10.3	↙
8:	10.2	↗
9:	10.1	↗
10:	9.9	↑

Serie	99 (3x)
Total	99 (3x)

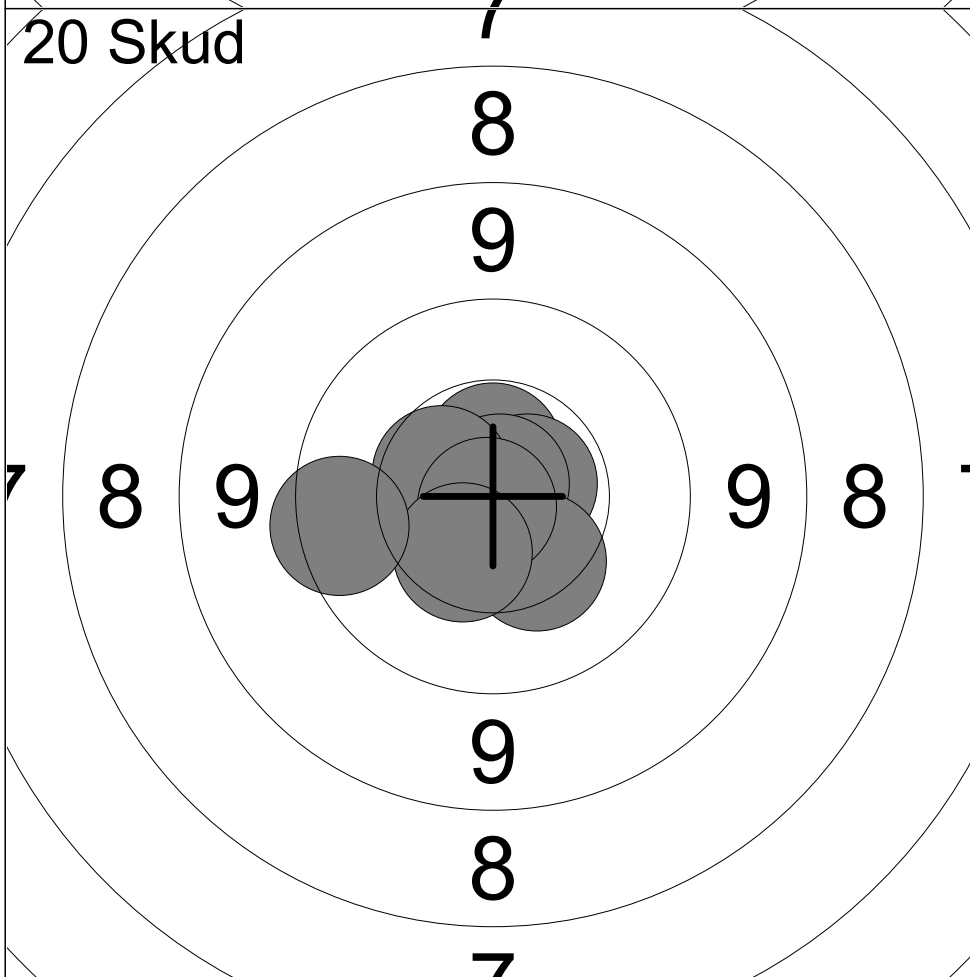

11:	10.6x	↑
12:	10.7x	→
13:	10.8x	↗
14:	10.6x	↓
15:	10.5	↙
16:	10.5	↘
17:	10.3	↘
18:	10.9x	↙
19:	10.5	↙
20:	9.7	←

Serie	99 (5x)
Total	198 (8x)

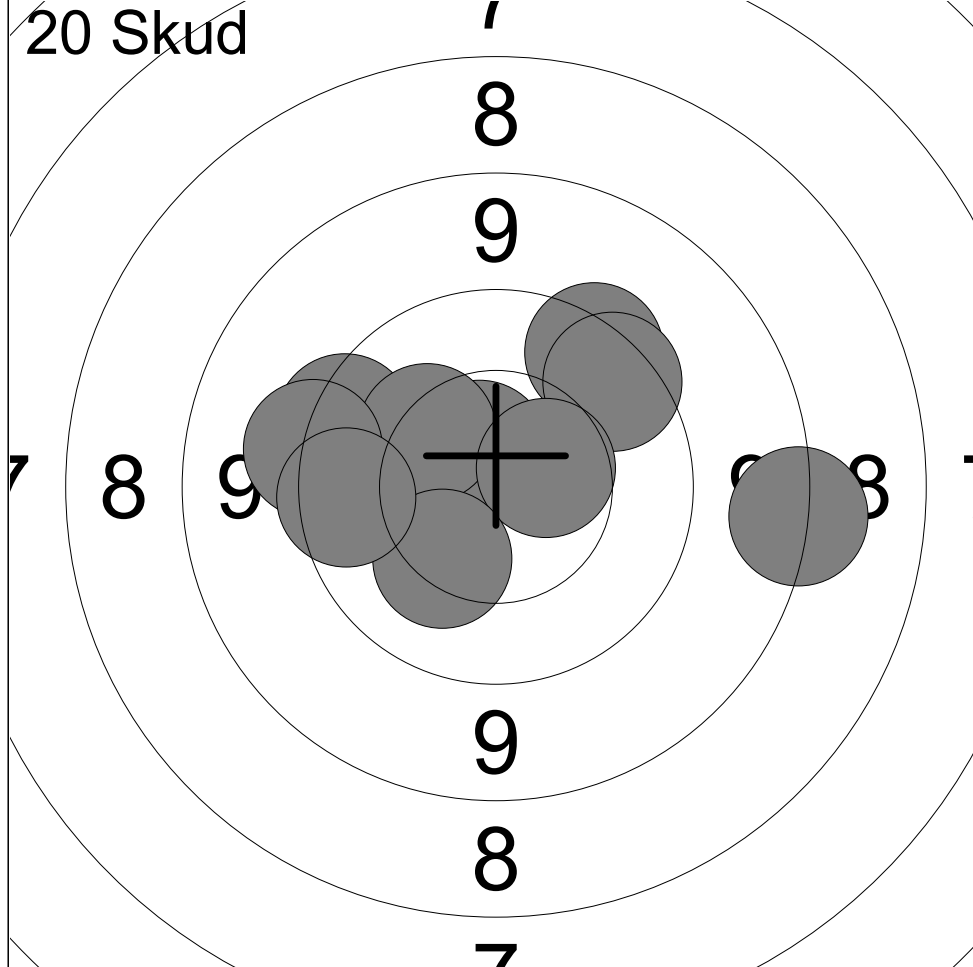

1:	10.6x	↗
2:	9.6	↖
3:	10.3	↗
4:	9.4	↖
5:	8.4	→
6:	9.6	↗
7:	9.7	↗
8:	10.5	→
9:	10.2	↘
10:	9.8	←

Serie	93 (1x)
Total	93 (1x)

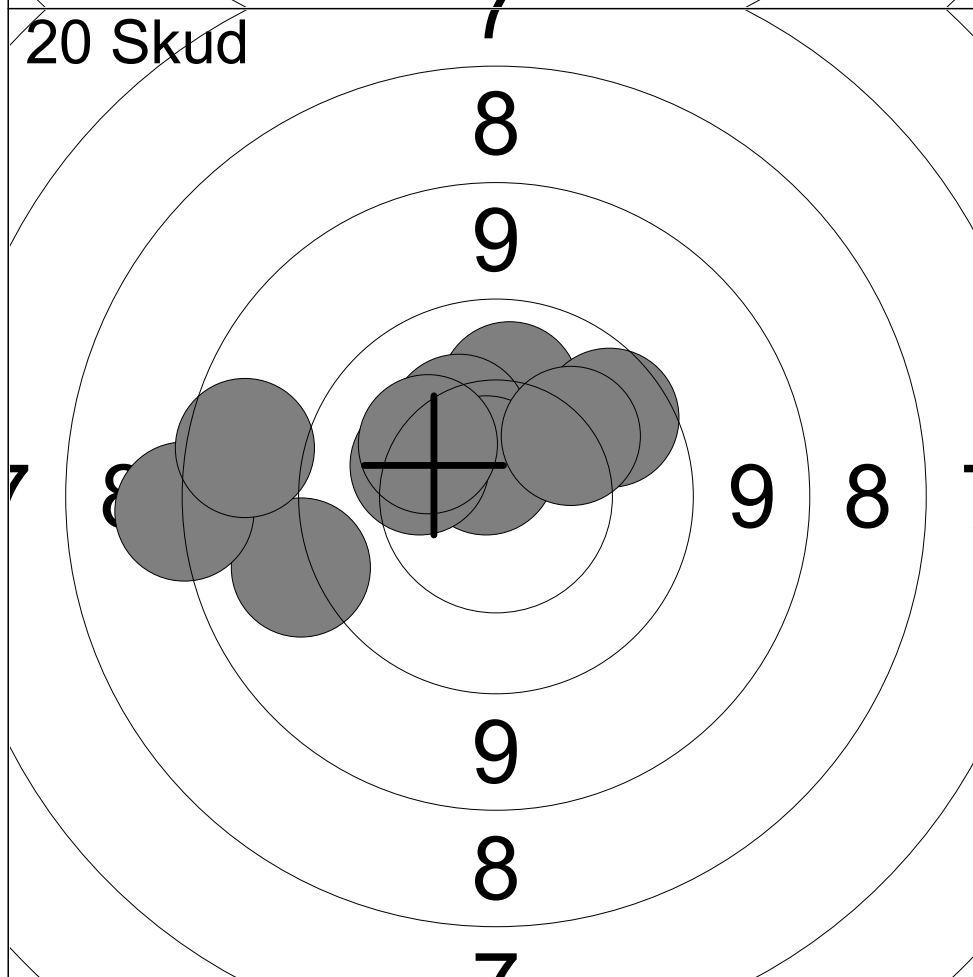

11:	10.1	↑
12:	9.3	←
13:	10.3	↗
14:	9.9	↗
15:	10.7x	↗
16:	10.3	↖
17:	8.4	←
18:	10.3	↗
19:	8.8	←
20:	10.2	↗

Serie	94 (1x)
Total	187 (2x)

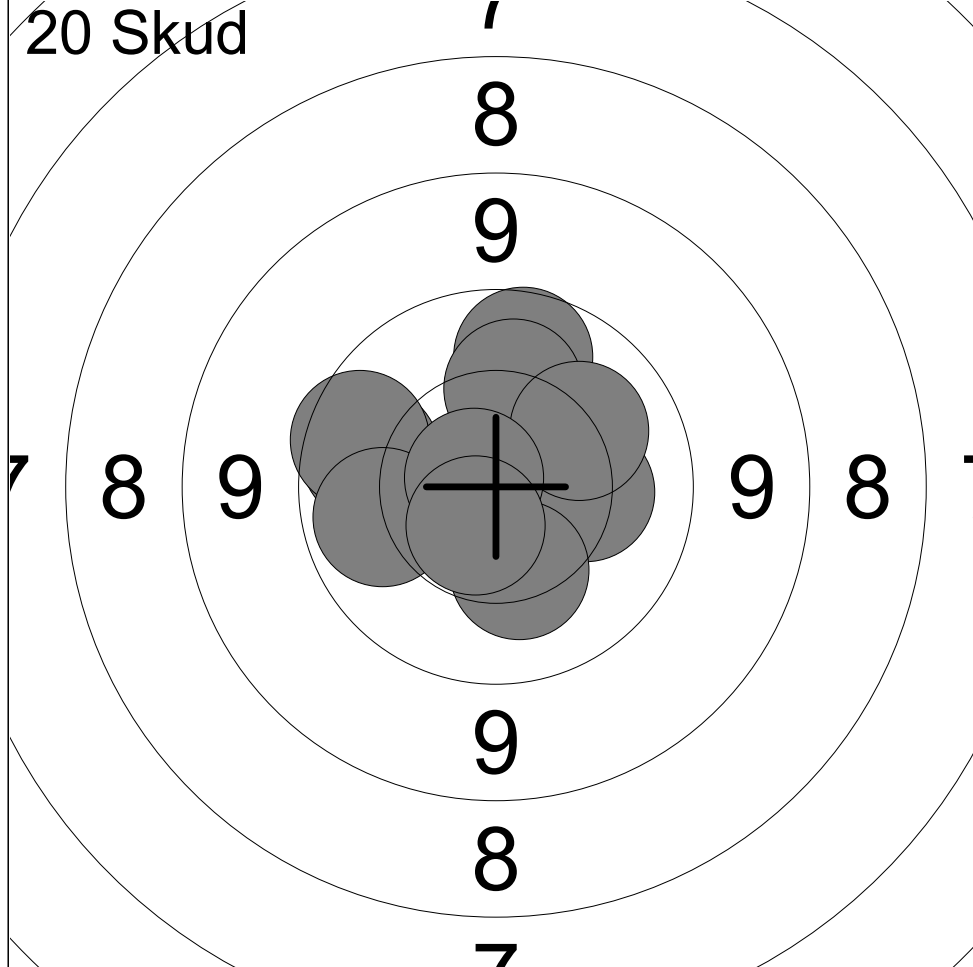

1:	10.2	→
2:	9.9	↑
3:	9.9	←
4:	10.2	↑
5:	10.2	↗
6:	9.8	←
7:	10.0	←
8:	10.3	↓
9:	10.8x	←
10:	10.6x	↙

Serie	97 (2x)
Total	97 (2x)

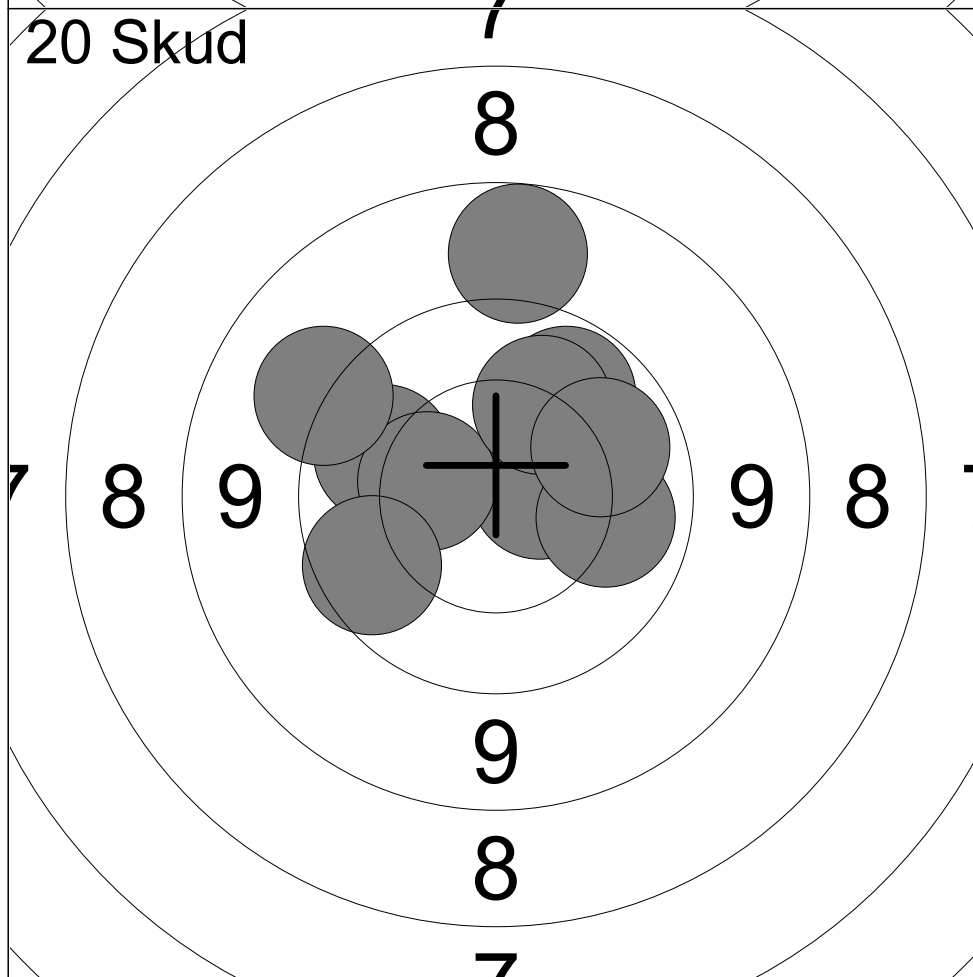

11:	9.0	↑
12:	10.0	←
13:	10.6x	→
14:	10.0	↗
15:	10.1	→
16:	10.4	←
17:	9.8	←
18:	10.1	↗
19:	10.0	↗
20:	9.3	←

Serie	97 (1x)
Total	194 (3x)

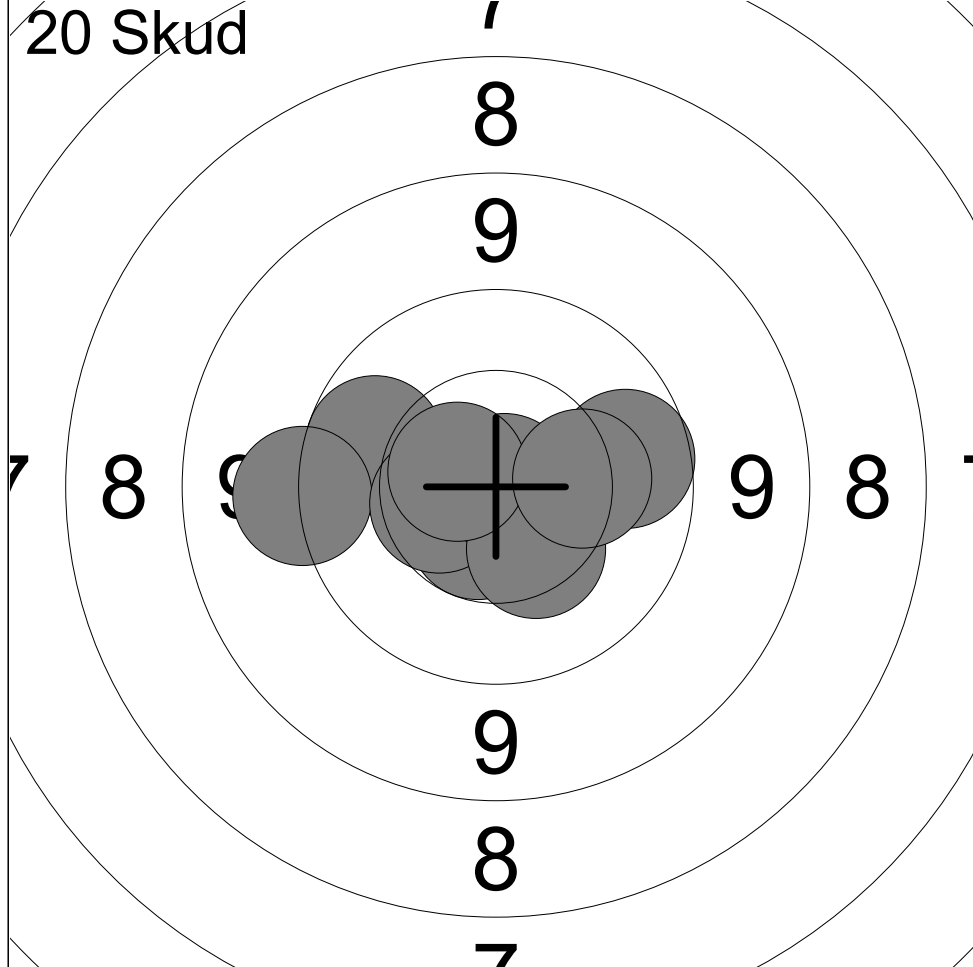

1:	10.6x	←
2:	9.9	↖
3:	10.6	↘
4:	9.4	←
5:	10.5	←
6:	10.9x	↗
7:	10.4	↘
8:	10.6x	←
9:	9.9	→
10:	10.3	→

Serie	97 (3x)
Total	97 (3x)

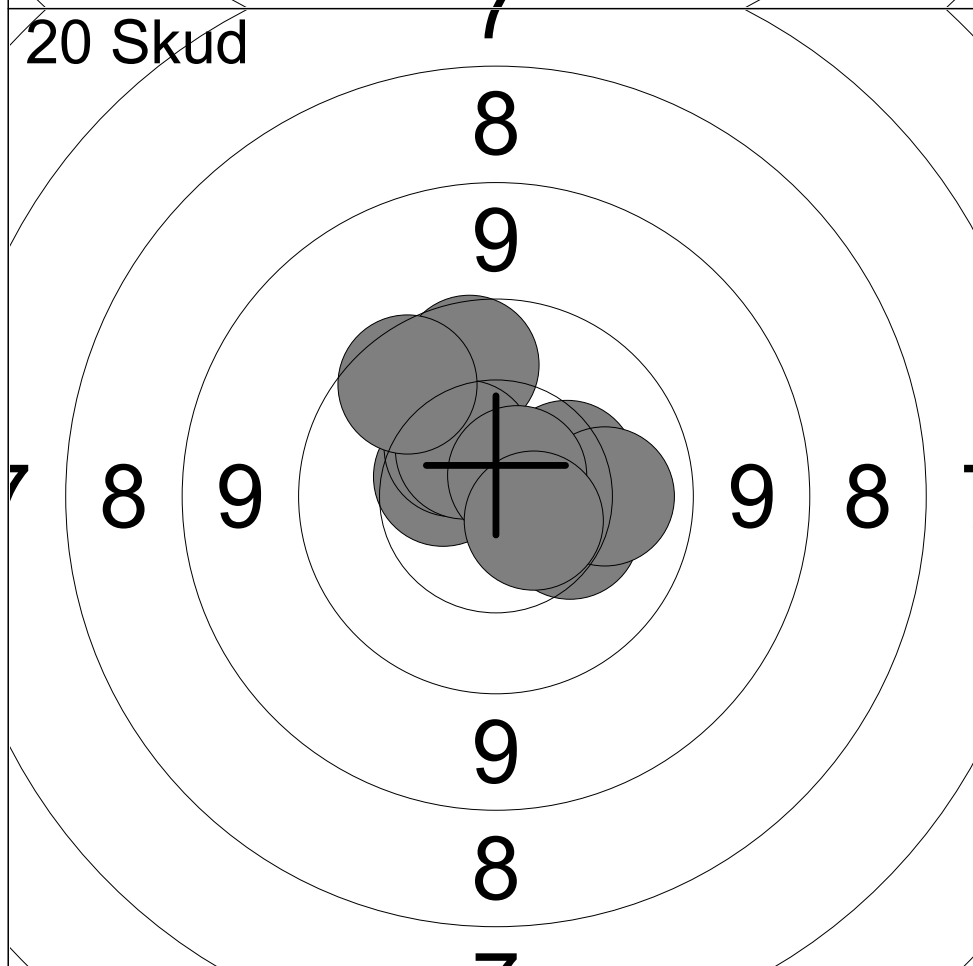

11:	9.9	↑
12:	10.4	↗
13:	10.5	↖
14:	10.4	↗
15:	10.5	↗
16:	10.3	↘
17:	10.1	→
18:	10.7x	↗
19:	9.8	↗
20:	10.6x	↘

Serie	98 (2x)
Total	195 (5x)

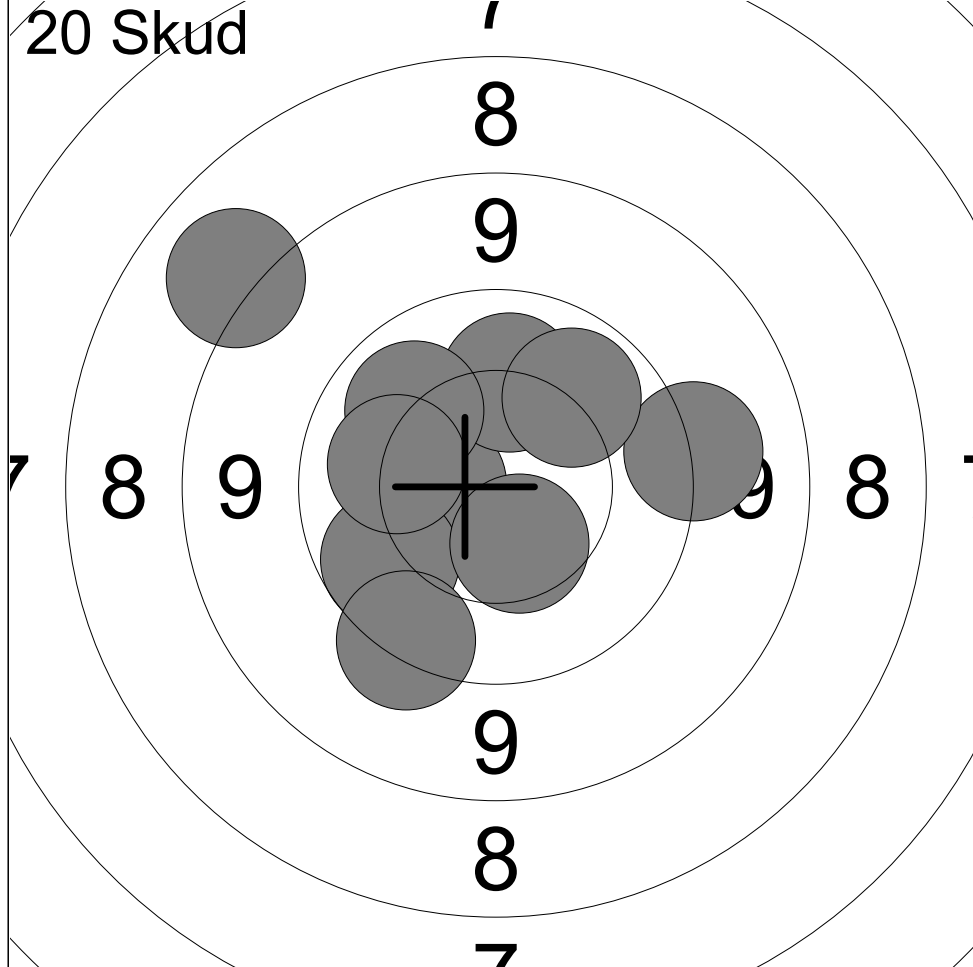

1:	10.5	←
2:	9.3	→
3:	10.1	↑
4:	10.1	↖
5:	9.9	↙
6:	10.0	↗
7:	10.5	↘
8:	8.2	↖
9:	10.2	←
10:	9.5	↙

Serie	95 (0x)
Total	95 (0x)

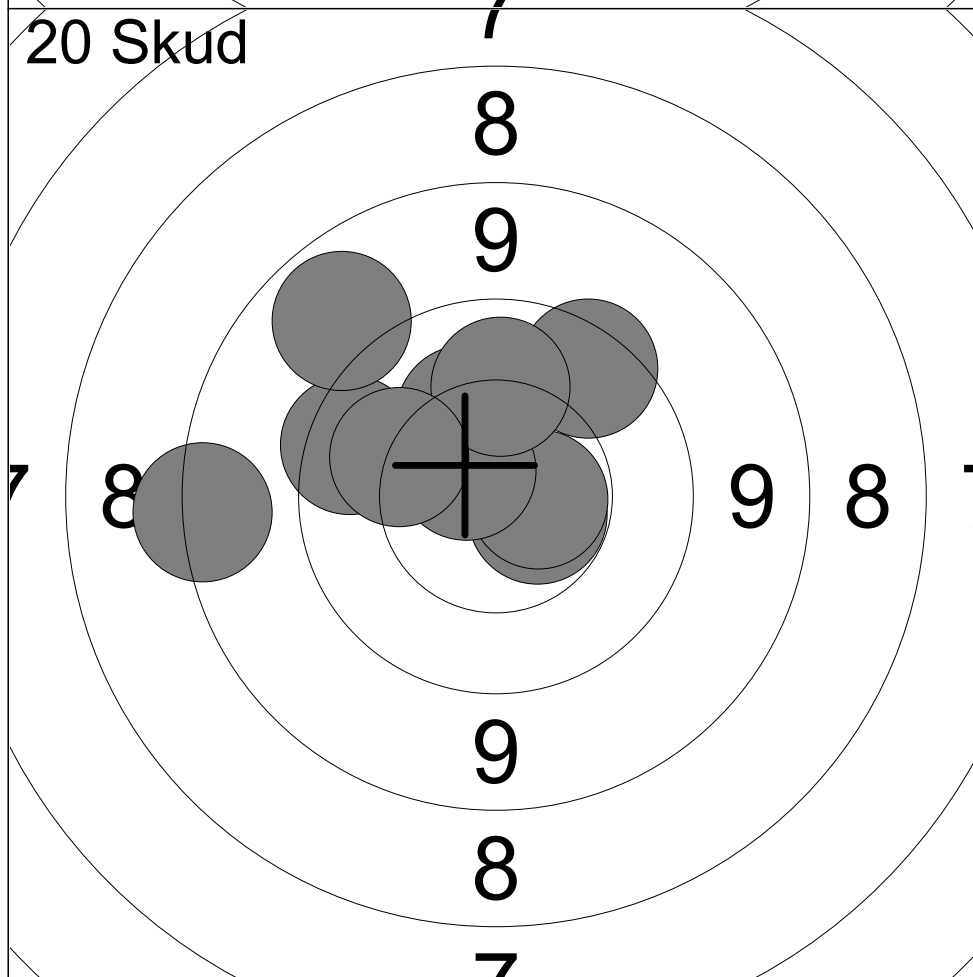

11:	8.5	←
12:	9.7	↖
13:	10.3	↑
14:	10.6x	↘
15:	10.6x	→
16:	9.7	↗
17:	9.0	↖
18:	10.6x	↖
19:	10.1	↑
20:	10.1	↖

Serie	95 (3x)
Total	190 (3x)

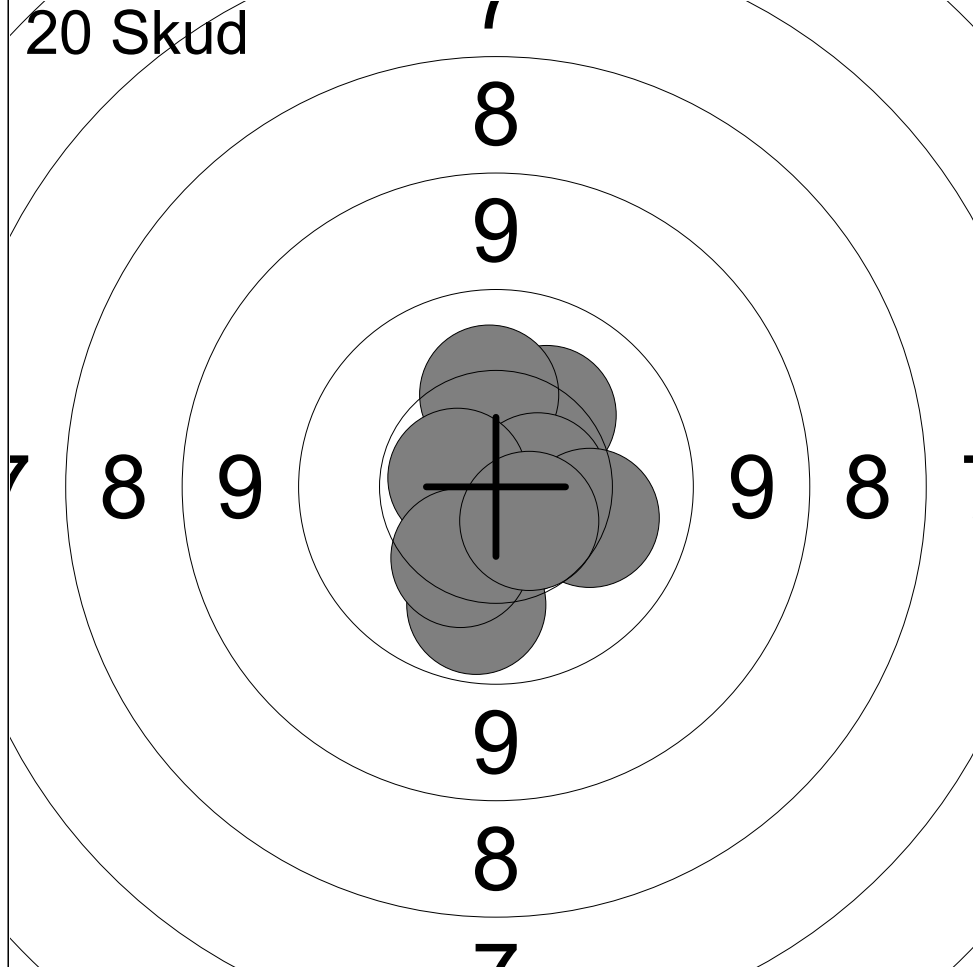

1:	10.3	↗
2:	10.6x	↘
3:	10.0	↘
4:	10.8x	↘
5:	10.2	↗
6:	10.6x	→
7:	10.2	↘
8:	10.6x	←
9:	10.3	↘
10:	10.6	↘

Serie	100 (4x)
Total	100 (4x)

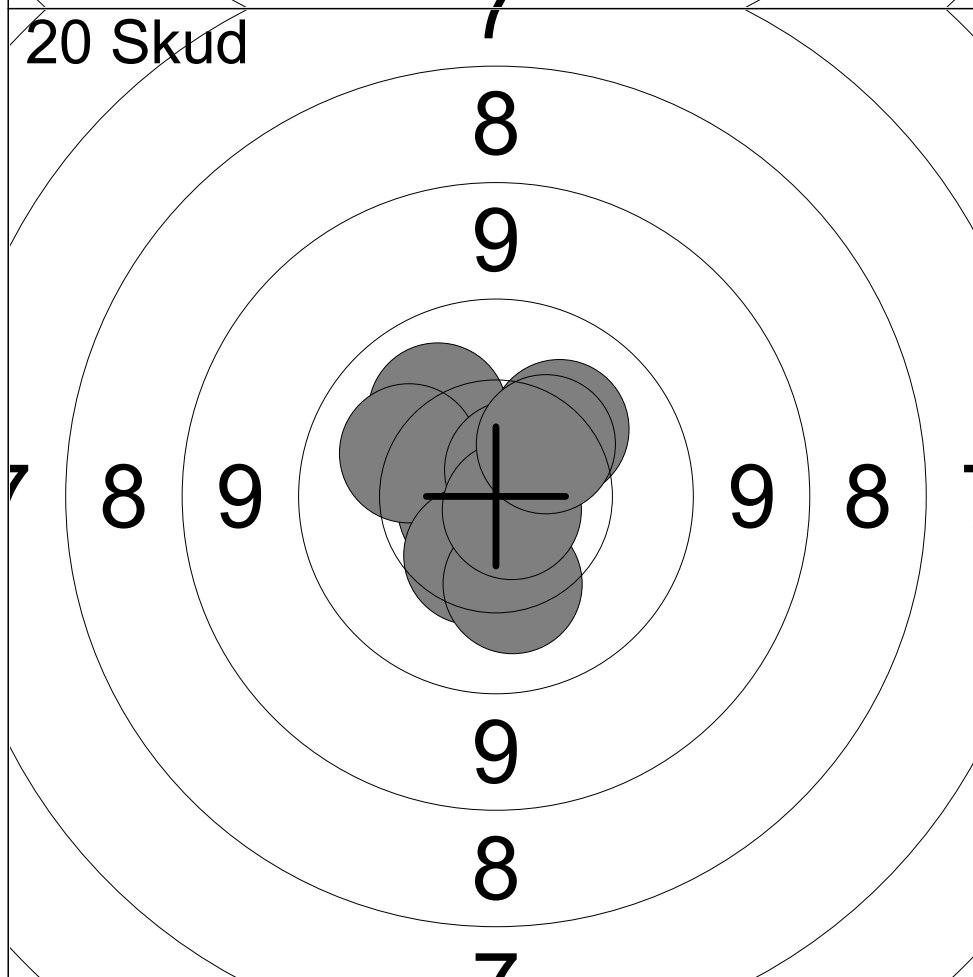

11:	10.1	↗
12:	10.7x	←
13:	10.2	↗
14:	10.9x	↗
15:	10.2	←
16:	10.5	↘
17:	10.7x	↗
18:	10.3	↘
19:	10.8x	↘
20:	10.4	↗

Serie	100 (4x)
Total	200 (8x)

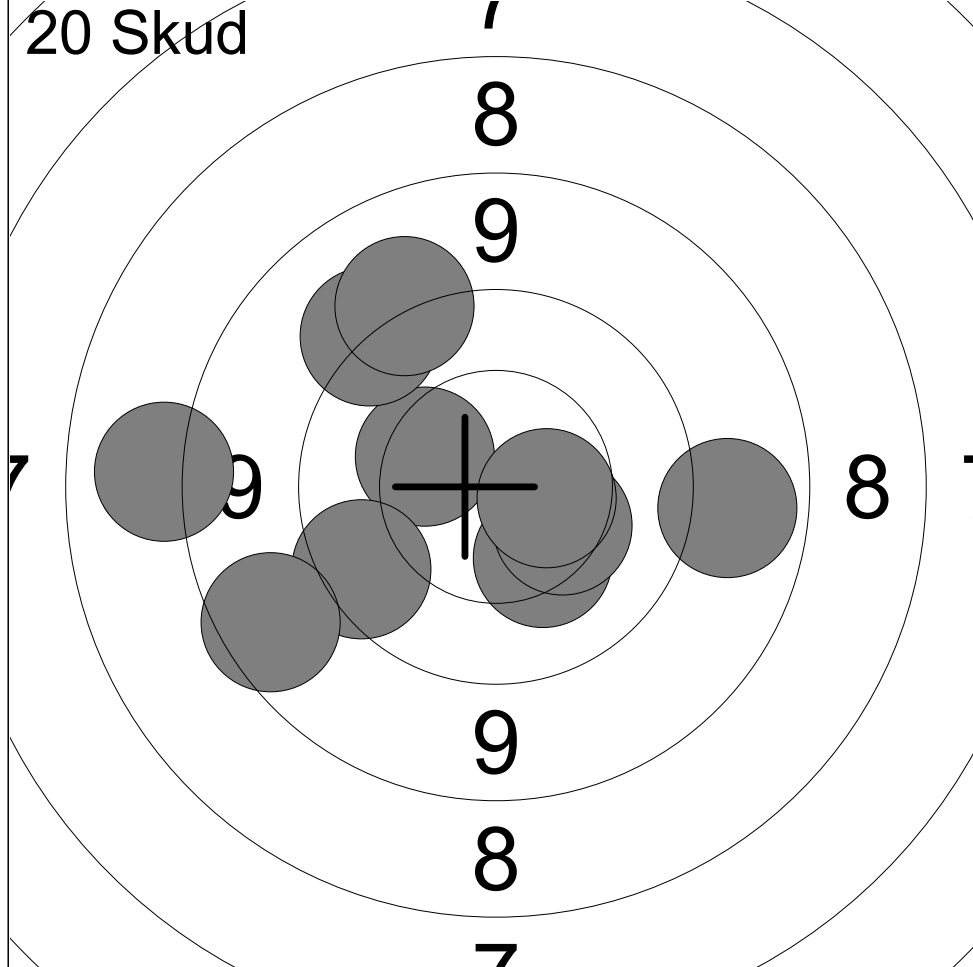

1:	10.3	↘
2:	10.3	↗
3:	9.4	↗
4:	8.2	←
5:	9.7	↙
6:	8.8	↙
7:	9.3	↗
8:	10.3	↘
9:	10.5	→
10:	9.1	→

Serie	92 (0x)
Total	92 (0x)

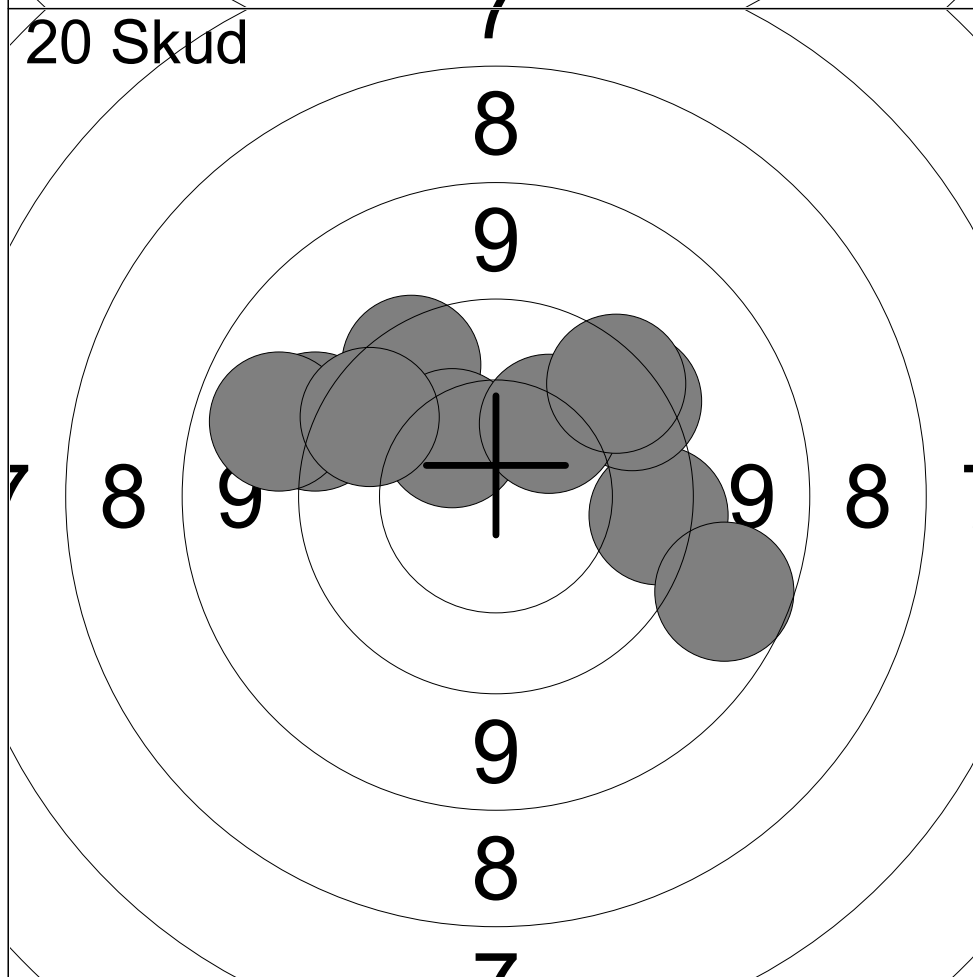

11:	9.7	↗
12:	9.6	→
13:	8.9	↘
14:	9.4	↗
15:	9.6	↗
16:	10.4	↗
17:	10.2	↗
18:	9.6	↗
19:	9.1	↙
20:	9.8	↙

Serie	91 (0x)
Total	183 (0x)

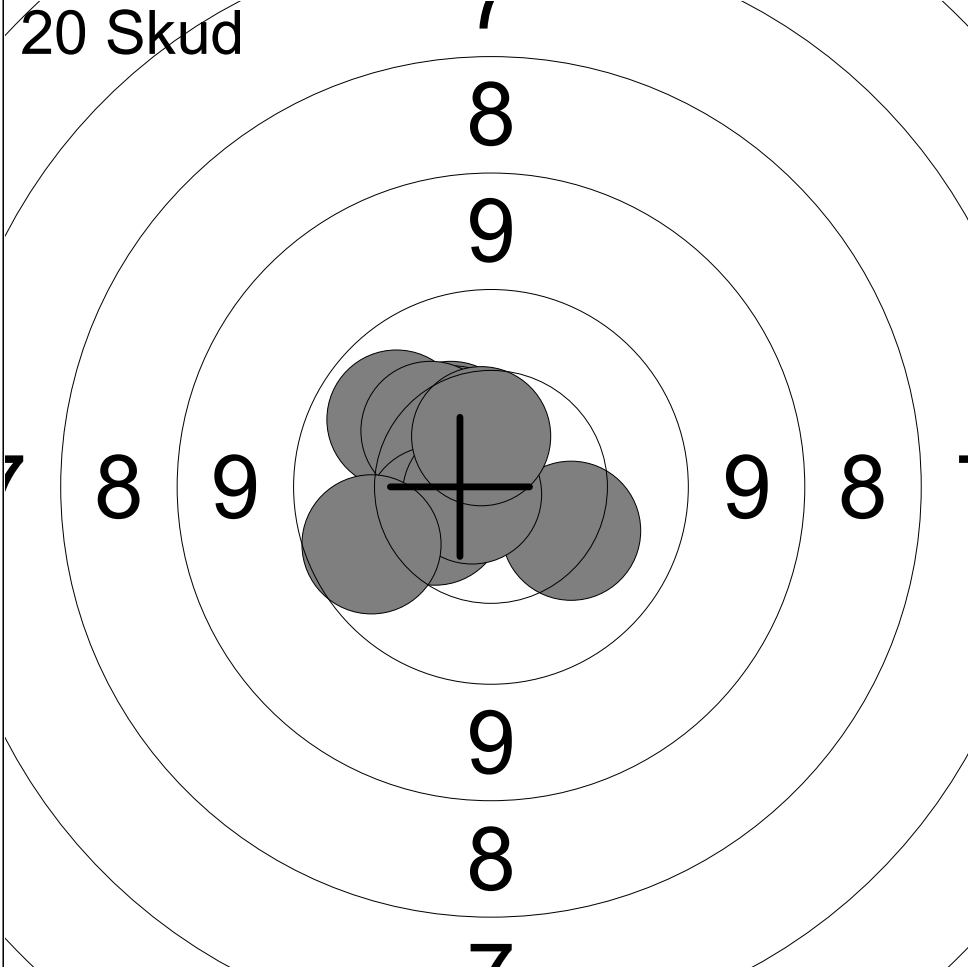

1:	10.4	↗
2:	10.5	↗
3:	10.0	↗
4:	10.5	↗
5:	10.3	↗
6:	10.5	↖
7:	10.2	↘
8:	10.8x	↖
9:	9.9	↖
10:	10.5	↗

Serie	99 (1x)
Total	99 (1x)

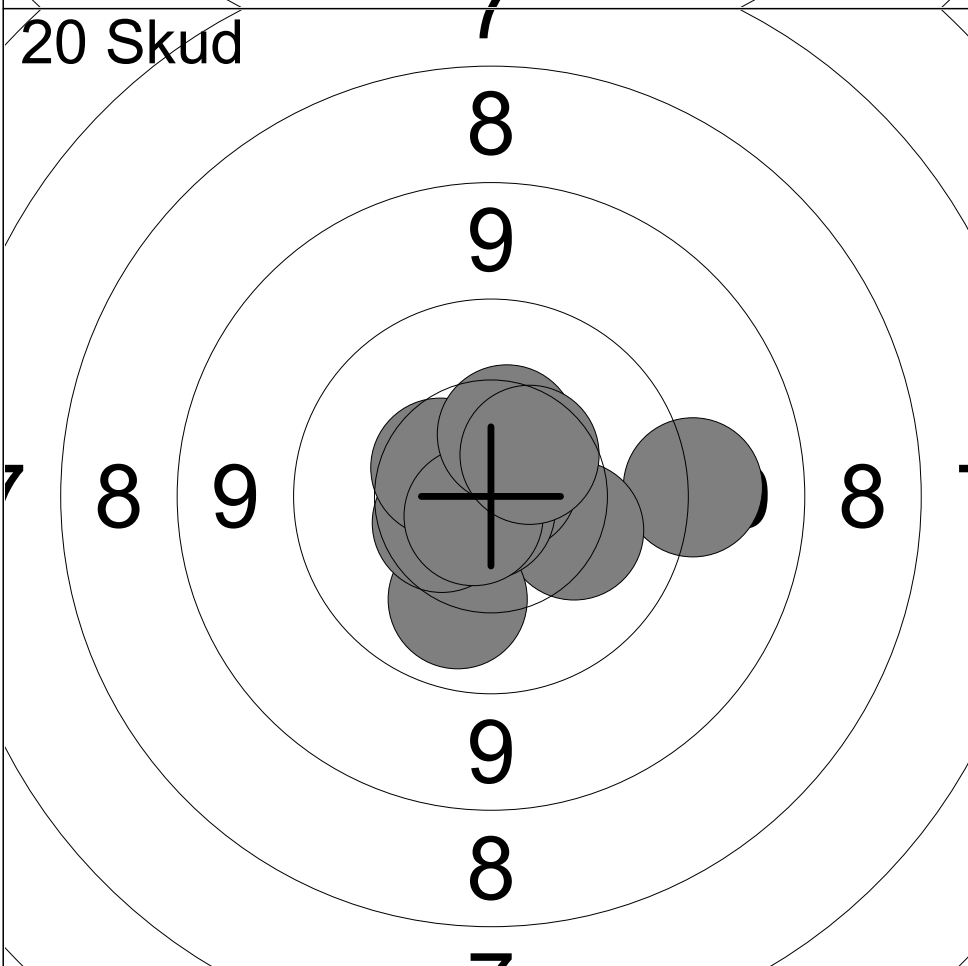

11:	9.3	→
12:	10.2	↘
13:	10.1	↘
14:	10.8x	↗
15:	10.5	↖
16:	10.5	↖
17:	10.8x	↘
18:	10.7x	↖
19:	10.5	↗
20:	10.5	↗

Serie	99 (3x)
Total	198 (4x)

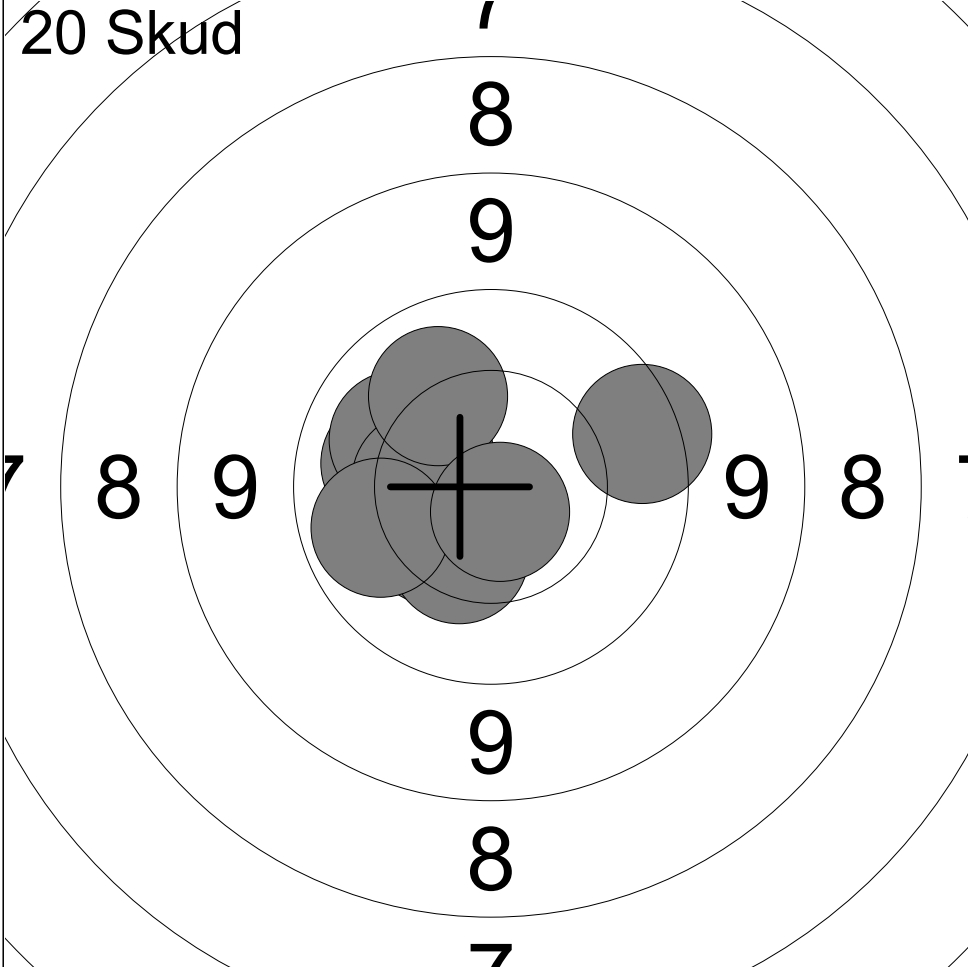

1:	10.4	↖
2:	10.1	↖
3:	10.4	↙
4:	10.1	↖
5:	10.4	↖
6:	10.4	↙
7:	10.0	↖
8:	10.1	↗
9:	10.7x	↘
10:	9.7	↗

Serie	99 (1x)
Total	99 (1x)

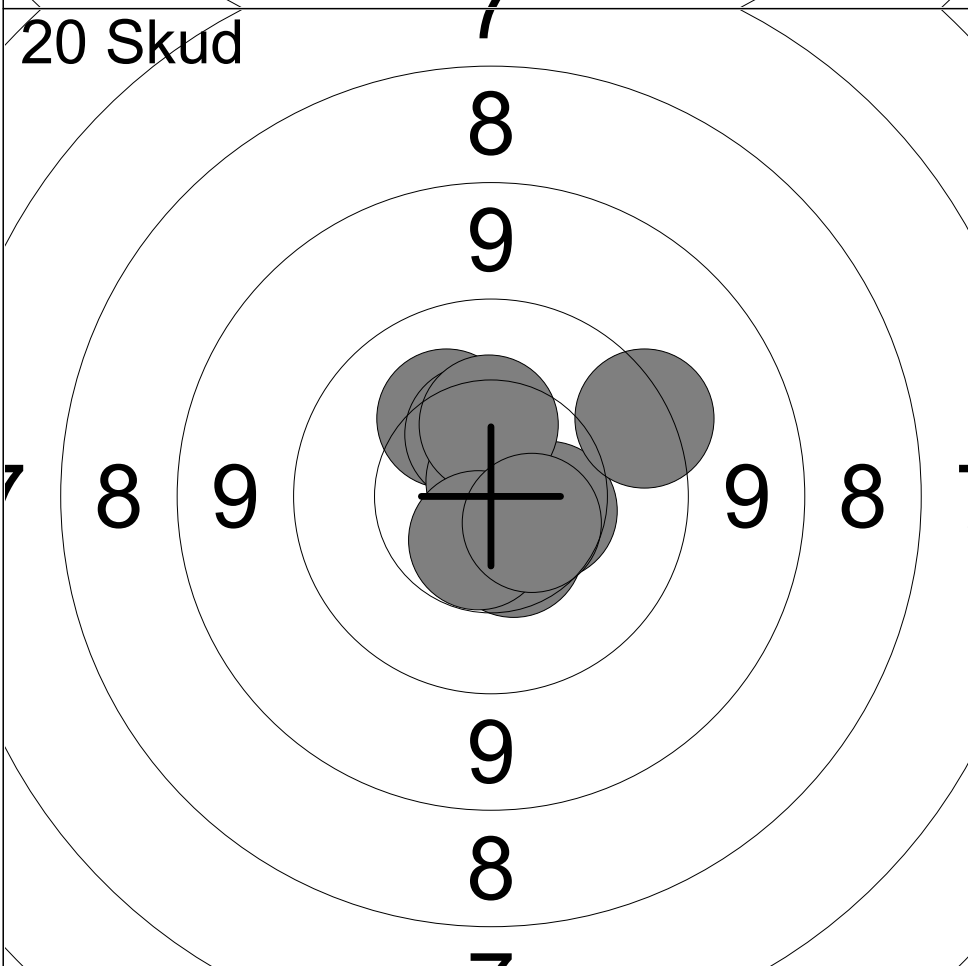

11:	10.2	↗
12:	10.4	↗
13:	10.8x	↗
14:	10.5	↘
15:	10.4	↗
16:	9.6	↗
17:	10.6x	↘
18:	10.5	↘
19:	10.6x	↘
20:	10.6	↘

Serie	99 (3x)
Total	198 (4x)

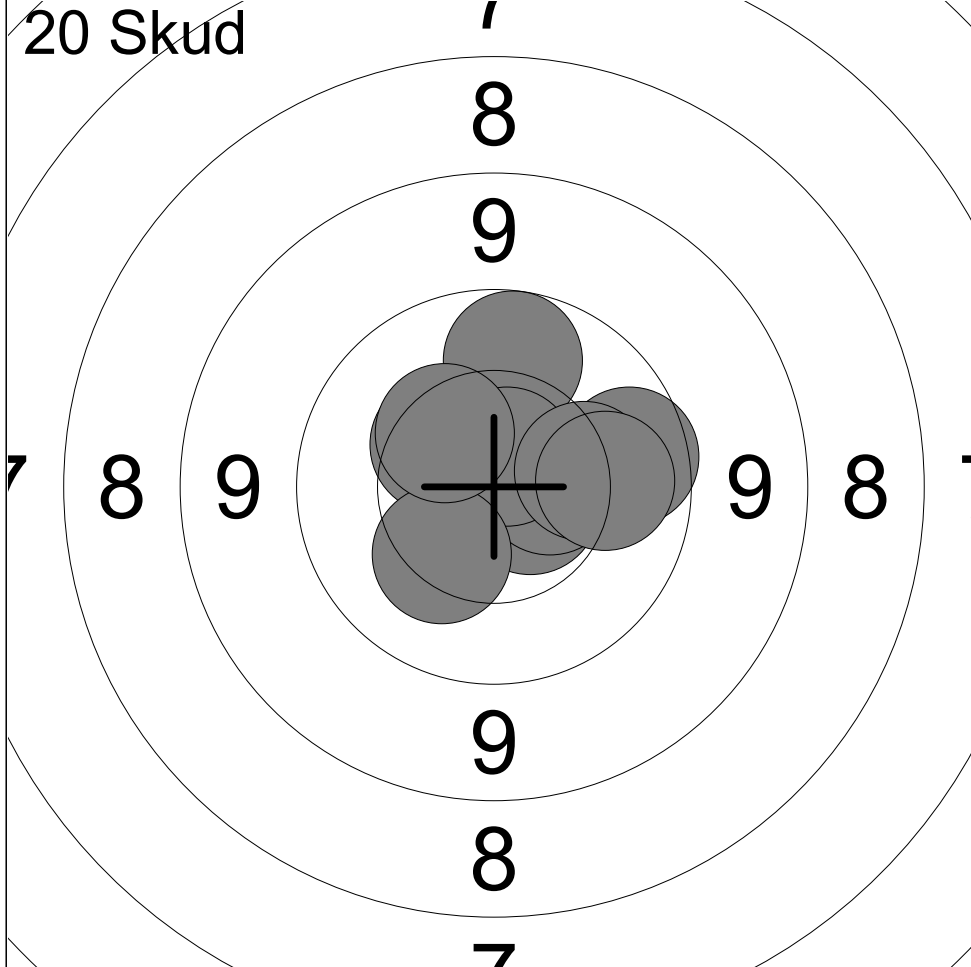

1:	9.9	→
2:	10.0	↑
3:	10.6x	↘
4:	10.5	→
5:	10.4	↗
6:	10.7x	↗
7:	10.3	↙
8:	10.2	→
9:	10.4	↗
10:	10.1	→

Serie	99 (2x)
Total	99 (2x)

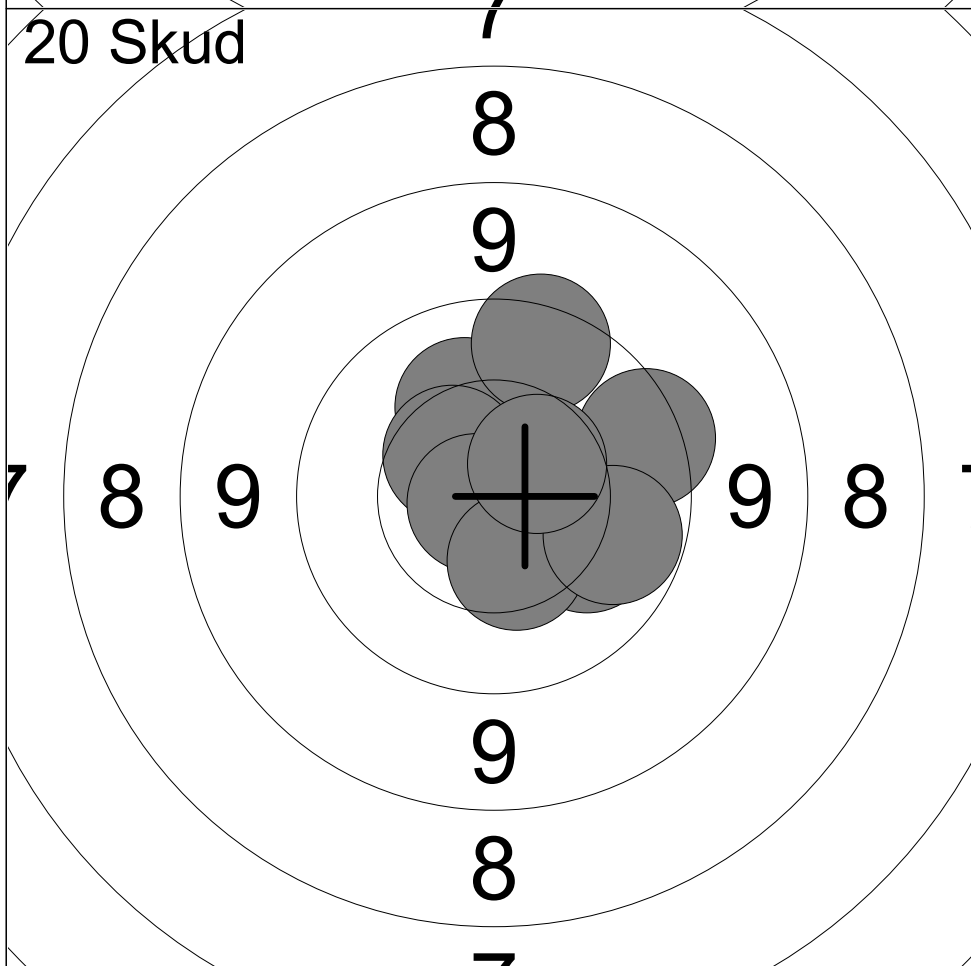

11:	10.7x	→
12:	10.2	↑
13:	10.1	↘
14:	10.5	↗
15:	9.7	→
16:	9.7	↑
17:	10.8x	←
18:	10.4	↘
19:	10.0	→
20:	10.5	↗

Serie	98 (2x)
Total	197 (4x)

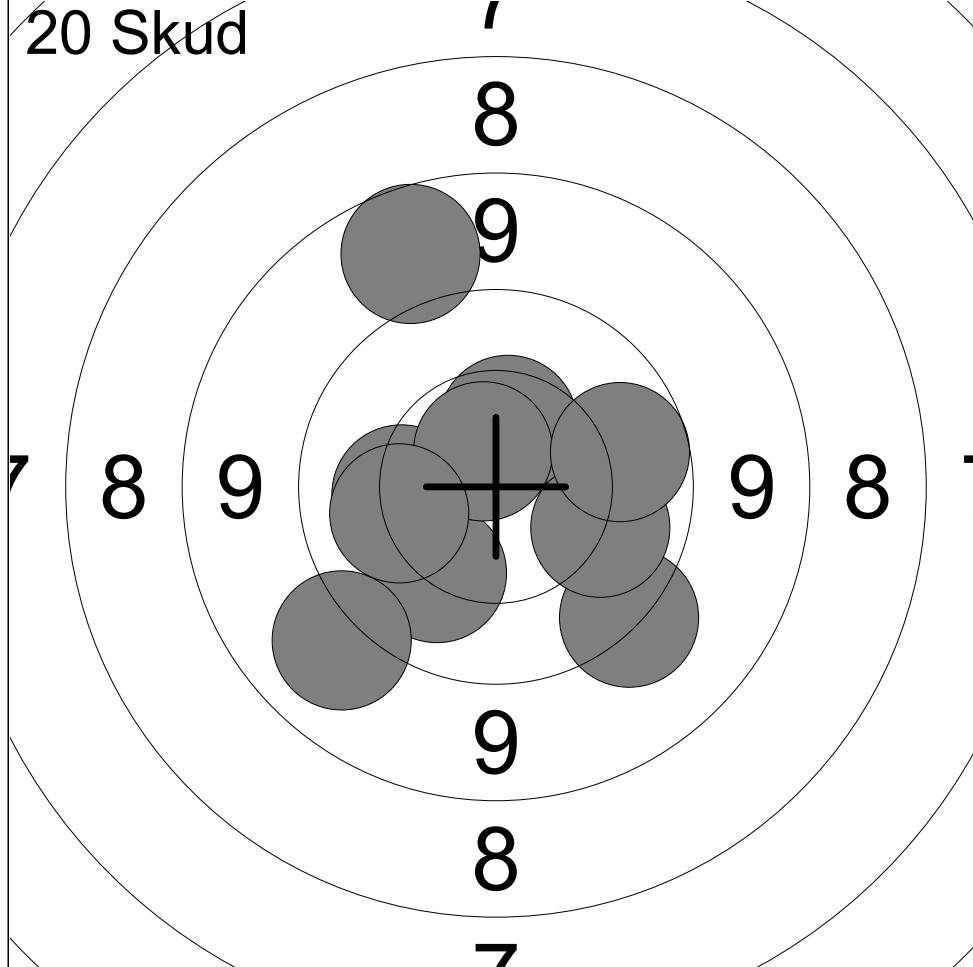

1:	9.4	↘
2:	10.1	↙
3:	10.2	←
4:	10.1	↗
5:	10.5	↗
6:	10.7x	↗
7:	9.9	→
8:	9.2	↙
9:	10.2	←
10:	8.9	↖

Serie	95 (1x)
Total	95 (1x)

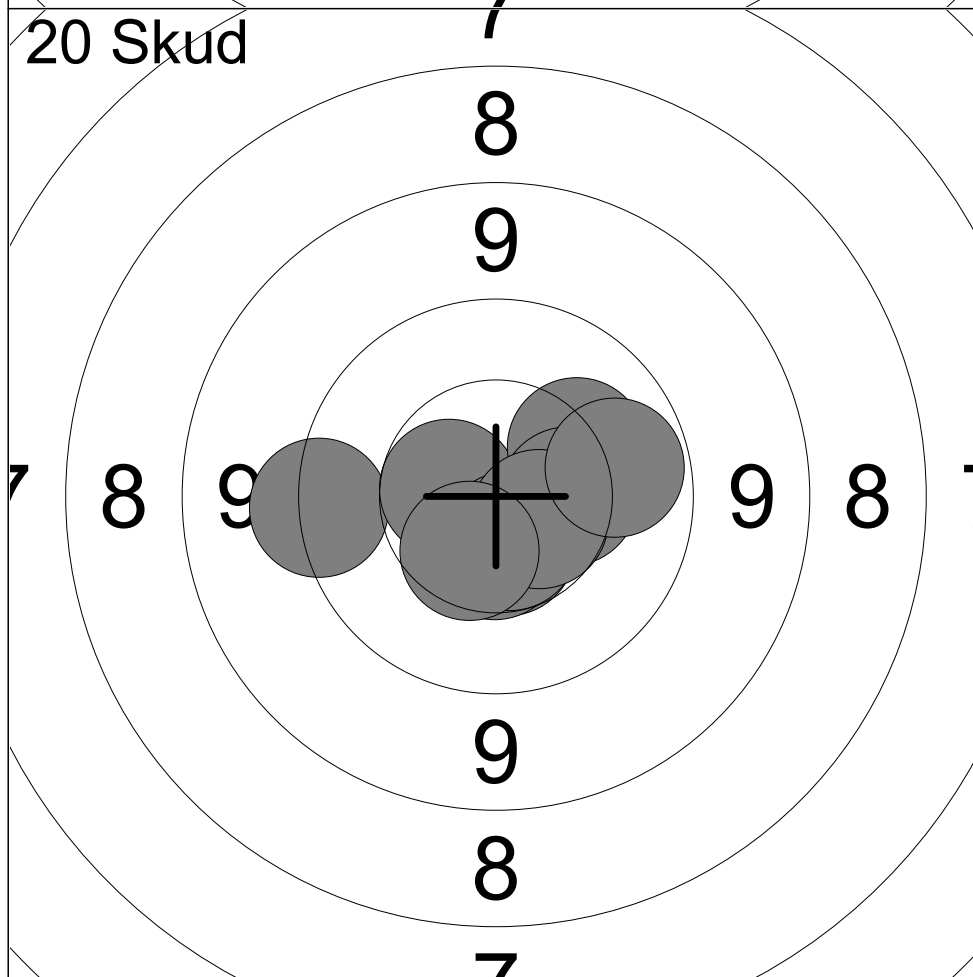

11:	10.5	↓
12:	10.5	↓
13:	9.5	←
14:	10.6	←
15:	10.2	↗
16:	10.6x	↓
17:	10.4	→
18:	10.6	↘
19:	10.0	→
20:	10.5	↙

Serie	99 (1x)
Total	194 (2x)

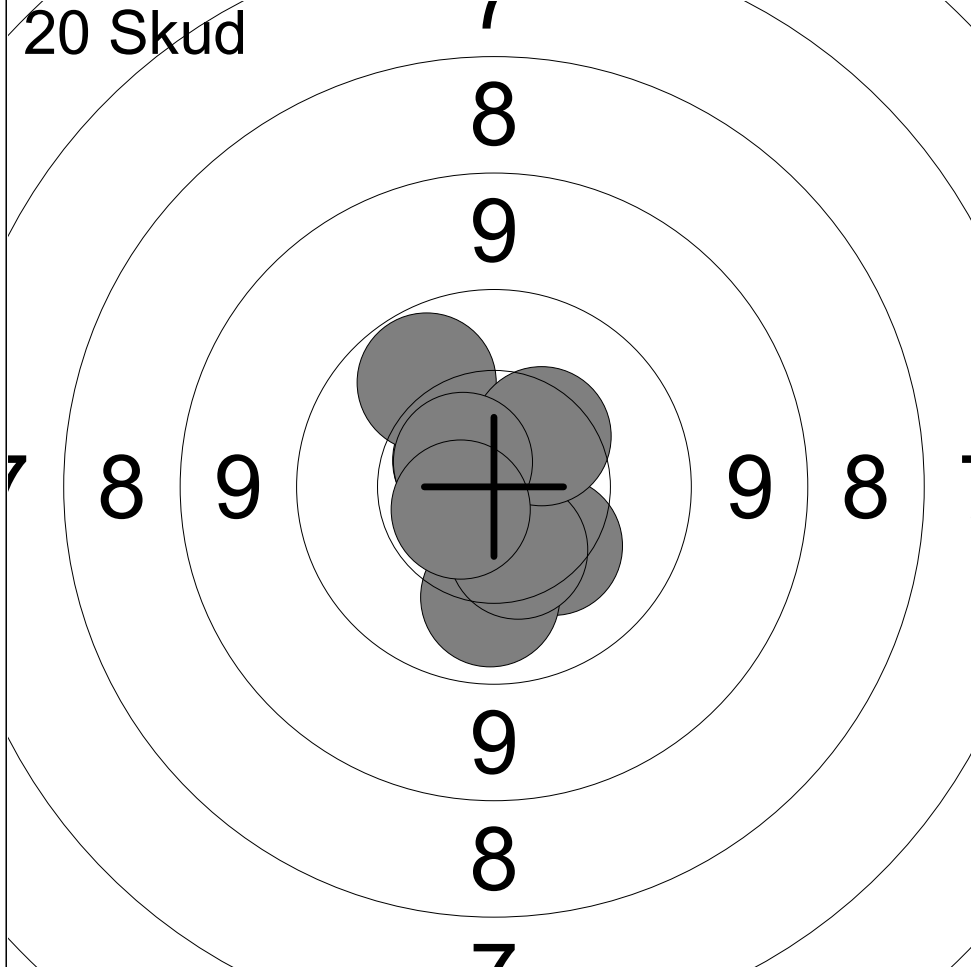

1:	10.6x	↖
2:	10.4	↓
3:	10.8x	↖
4:	10.3	↘
5:	10.1	↓
6:	10.4	↘
7:	10.0	↗
8:	10.4	↗
9:	10.6x	↗
10:	10.6x	↙

Serie	100 (4x)
Total	100 (4x)

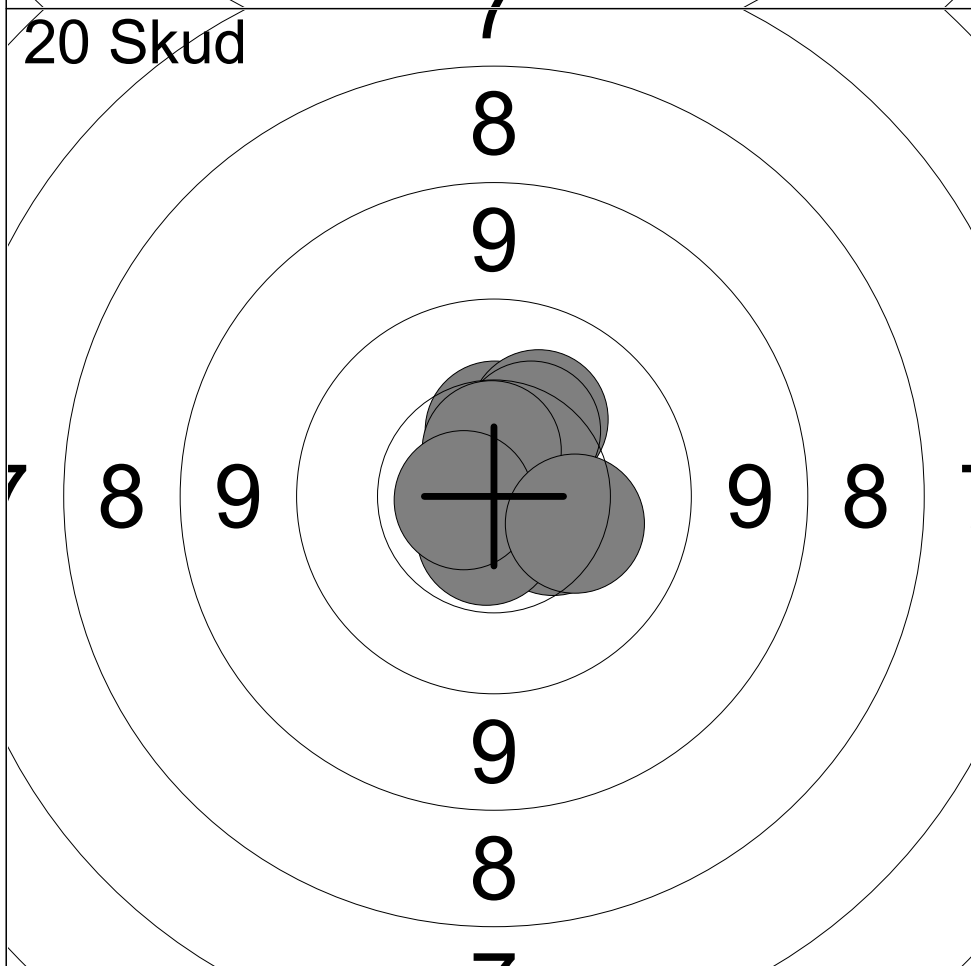

11:	10.4	↑
12:	10.4	↘
13:	10.7x	↗
14:	10.6x	↓
15:	10.7x	↑
16:	10.3	↗
17:	10.4	↗
18:	10.6x	↑
19:	10.7x	↖
20:	10.3	↘

Serie	100 (5x)
Total	200 (9x)

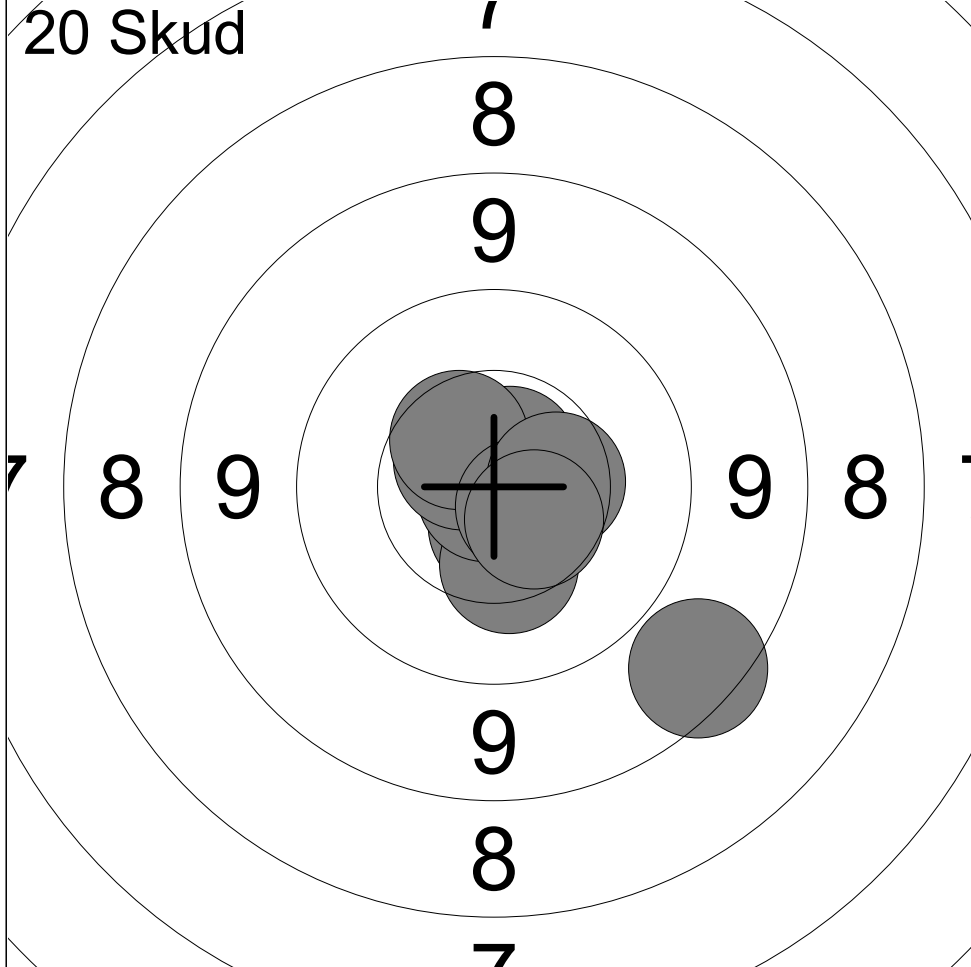

1:	10.6x	↓
2:	8.7	↘
3:	10.3	↓
4:	10.7x	↗
5:	10.9x	↙
6:	10.6x	↗
7:	10.5	↗
8:	10.7x	↘
9:	10.5	→
10:	10.5	↘

Serie	98 (5x)
Total	98 (5x)

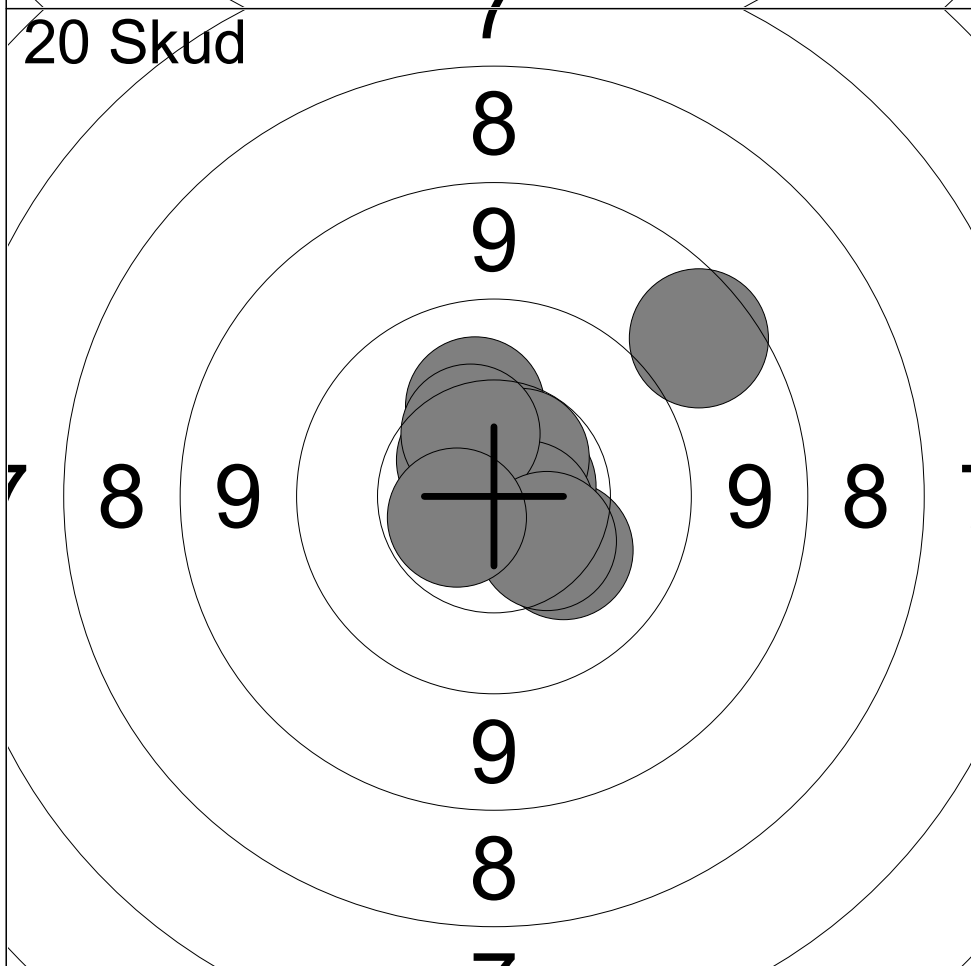

11:	10.3	↘
12:	8.8	↗
13:	10.2	↑
14:	10.6x	↗
15:	10.7x	→
16:	10.6x	↗
17:	10.7x	↘
18:	10.4	↗
19:	10.4	↘
20:	10.6x	↙

Serie	98 (5x)
Total	196 (10x)

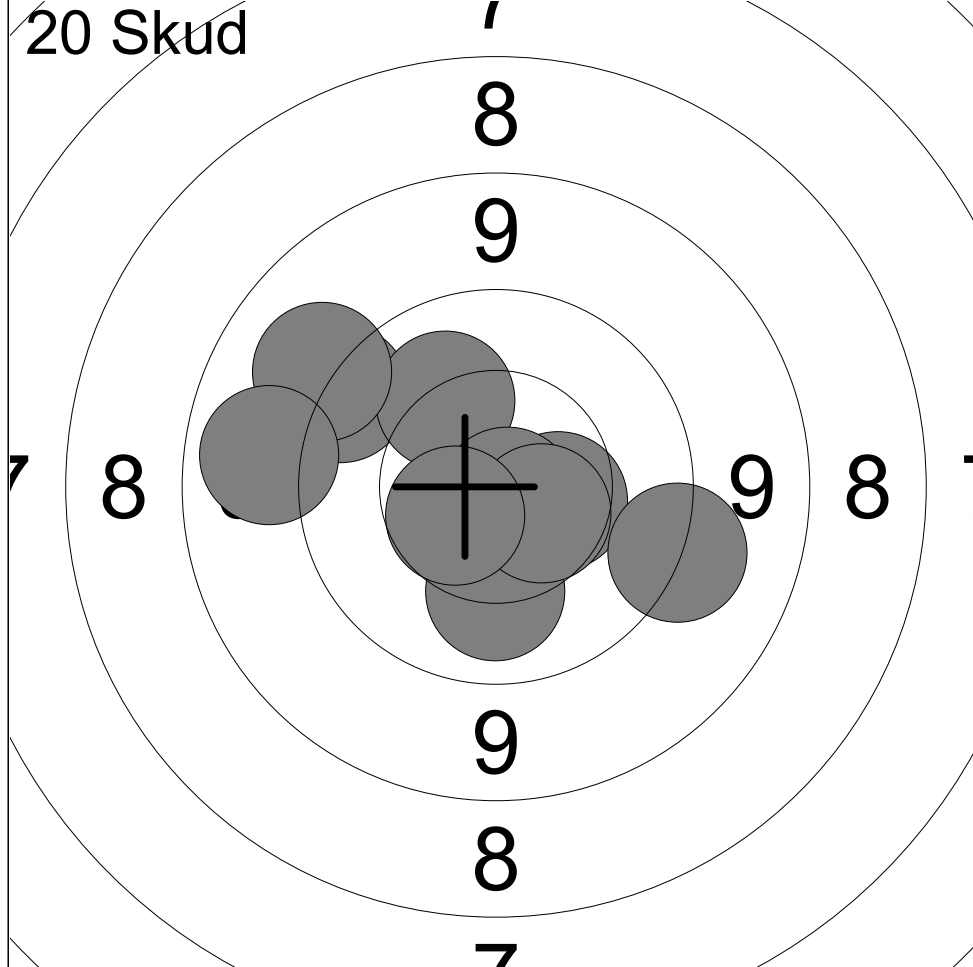

1:	9.5	↗
2:	10.2	↗
3:	10.5	→
4:	10.1	↓
5:	10.8x	↘
6:	9.4	↘
7:	10.5	↘
8:	9.3	↖
9:	10.6	↖
10:	9.1	←

Serie	96 (1x)
Total	96 (1x)

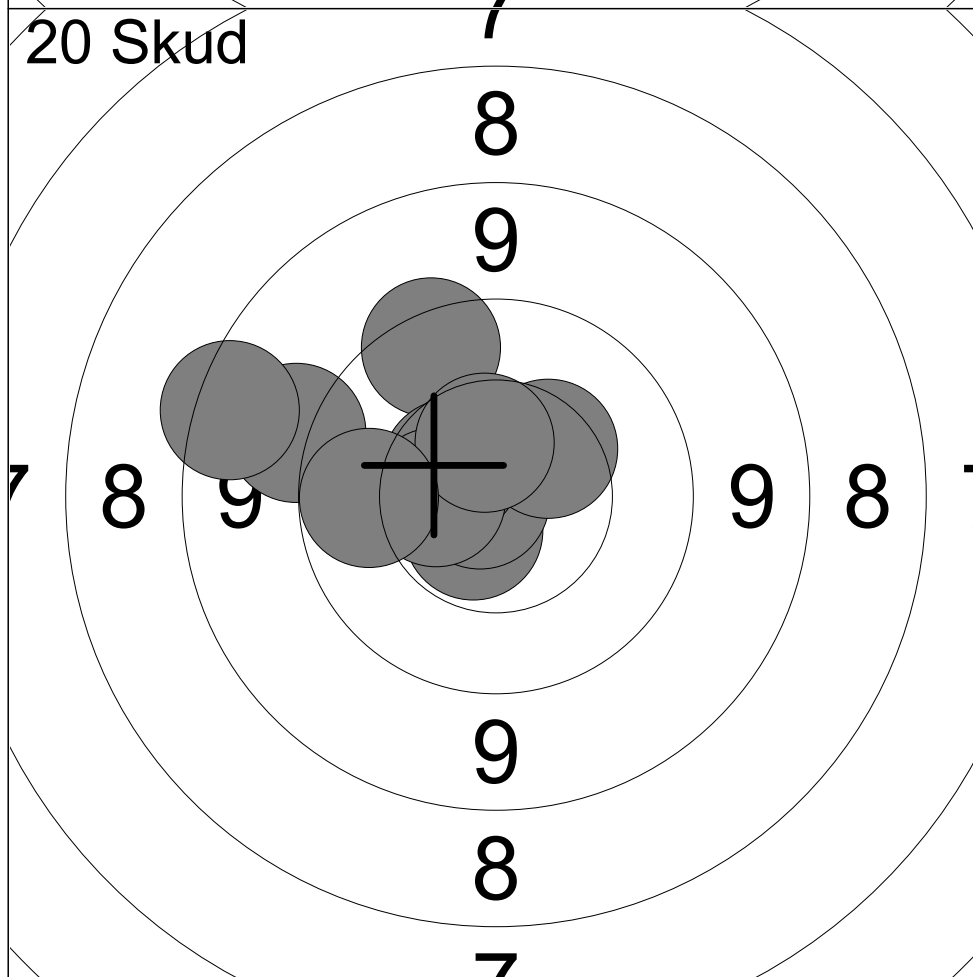

11:	10.6x	↘
12:	10.8x	←
13:	9.2	↖
14:	9.7	↖
15:	8.6	↖
16:	10.5	↖
17:	10.5	←
18:	10.4	↗
19:	10.5	↖
20:	10.0	←

Serie	96 (2x)
Total	192 (3x)

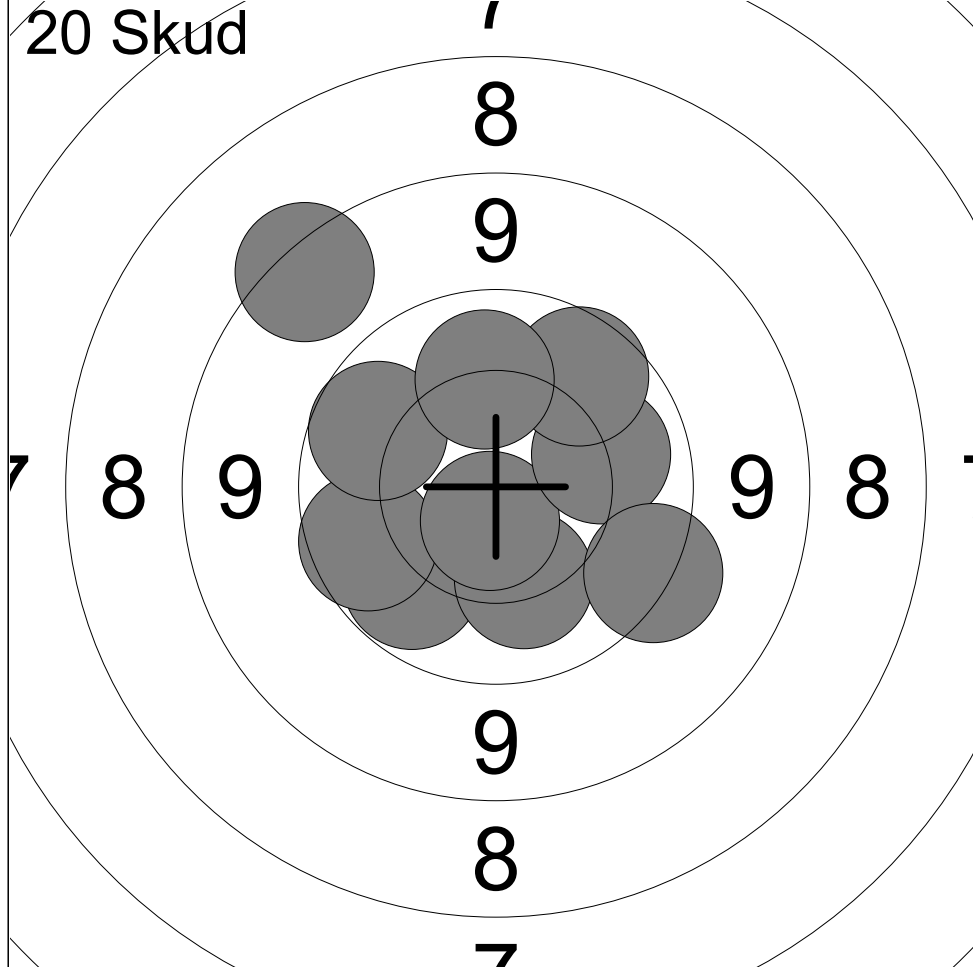

1:	10.0	↙
2:	10.2	↓
3:	9.9	↙
4:	10.7x	↓
5:	10.1	↗
6:	9.5	↘
7:	9.9	↗
8:	9.9	↙
9:	10.1	↑
10:	8.6	↖

Serie	94 (1x)
Total	94 (1x)

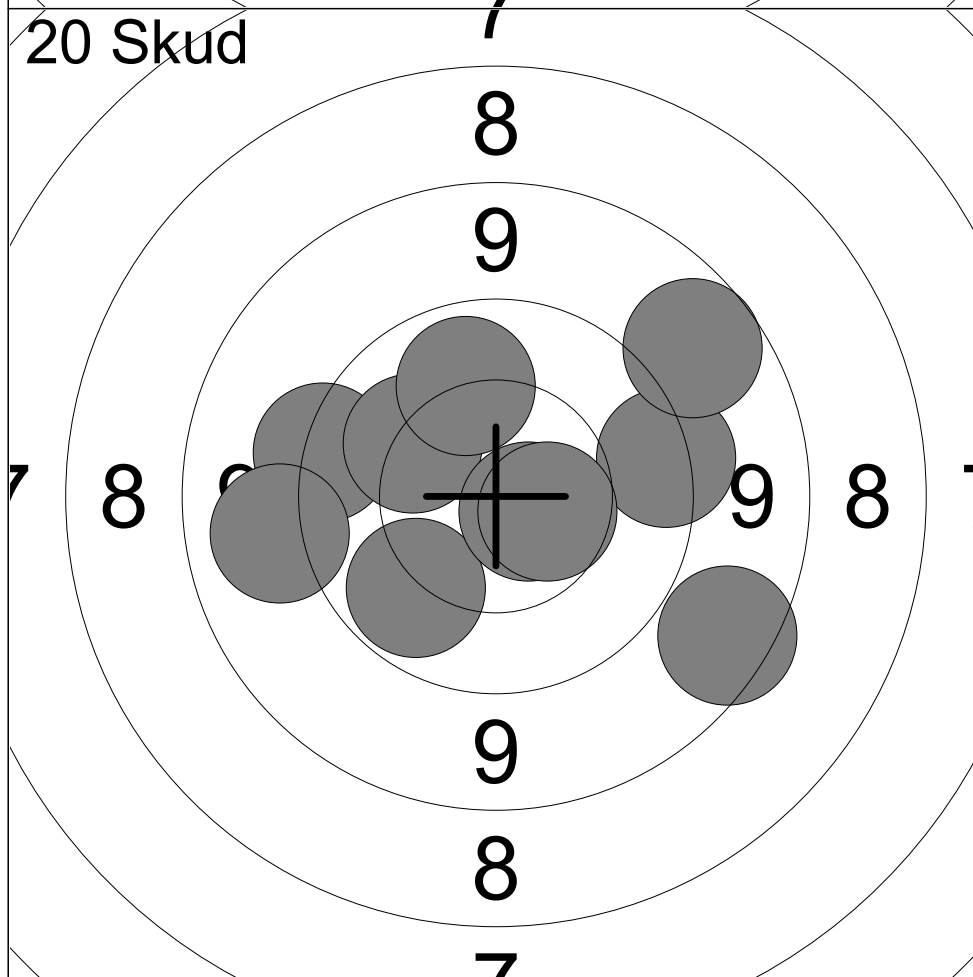

11:	10.0	↙
12:	9.5	↙
13:	10.2	↖
14:	9.5	↗
15:	9.2	↙
16:	10.1	↑
17:	8.9	↗
18:	10.7x	↘
19:	8.7	↘
20:	10.5	↘

Serie	93 (1x)
Total	187 (2x)

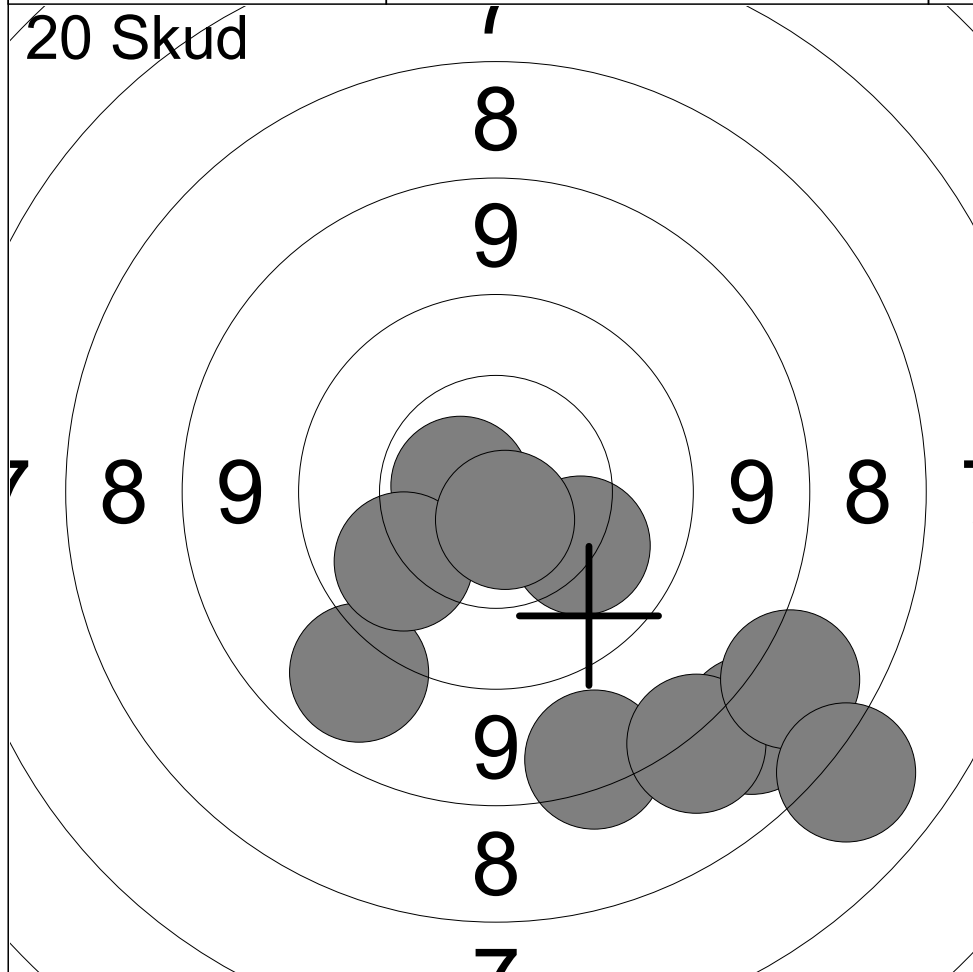

1:	8.6	↘
2:	10.7x	←
3:	9.1	↘
4:	10.0	↘
5:	8.1	↘
6:	8.3	↘
7:	8.1	↘
8:	7.2	↘
9:	10.2	↘
10:	10.7x	↘

Serie	88 (2x)
-------	----------

Total	88 (2x)
-------	----------

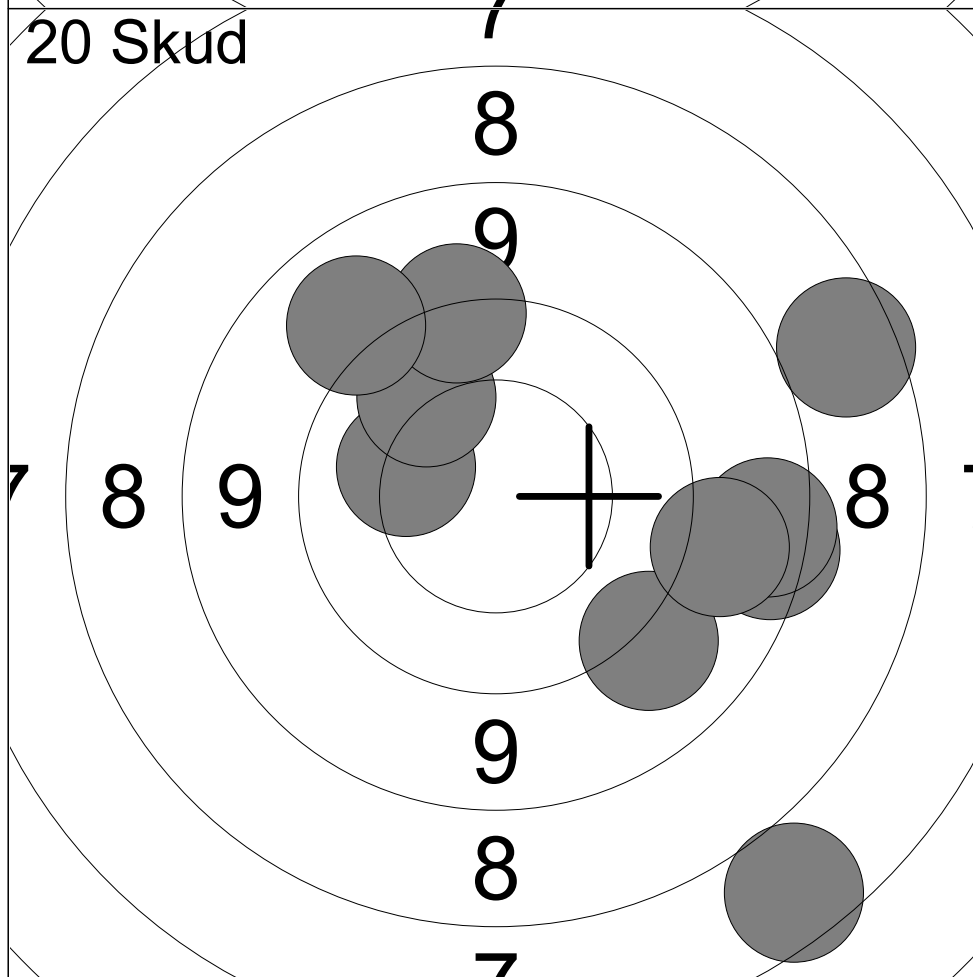

11:	10.2	↖
12:	9.2	↘
13:	10.0	↗
14:	9.4	↗
15:	8.6	↘
16:	6.8	↘
17:	7.8	↗
18:	8.7	↗
19:	9.1	↘
20:	9.2	↗

Serie	85 (0x)
-------	----------

Total	173 (2x)
-------	-----------

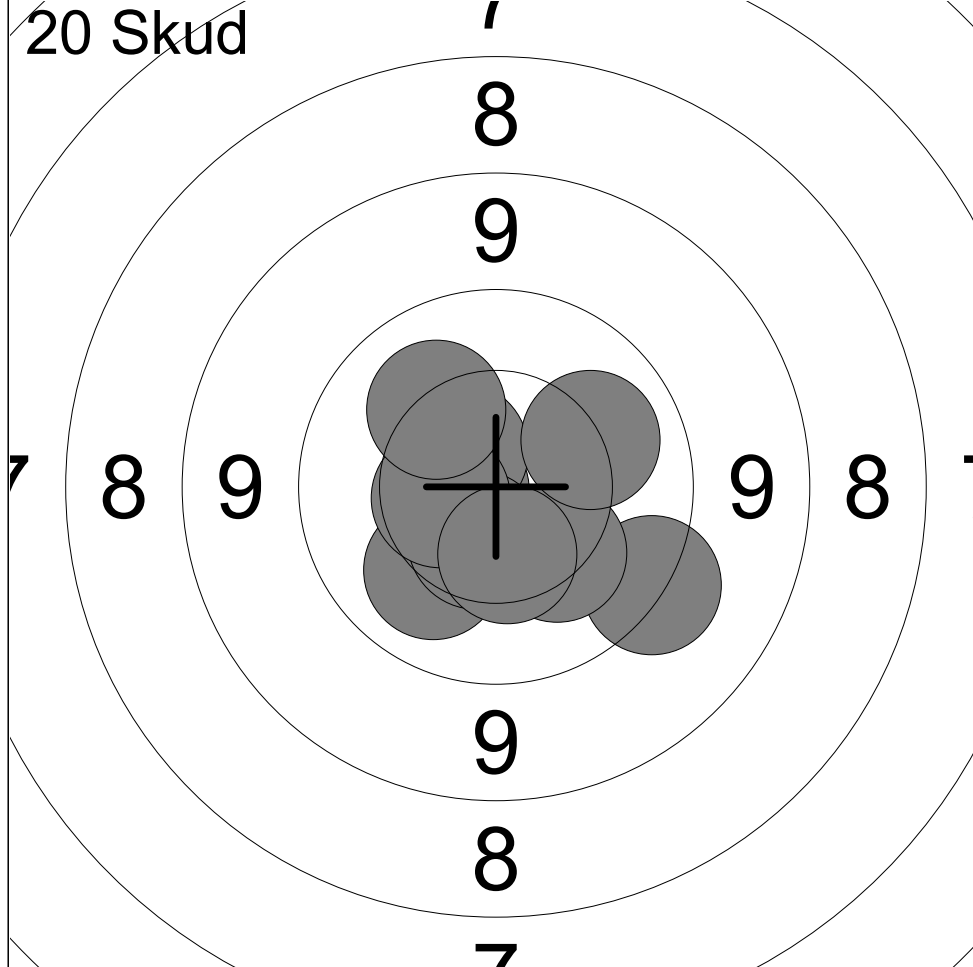

1:	10.7x	←
2:	10.1	↘
3:	10.6	↗
4:	9.5	↘
5:	10.2	↘
6:	10.1	↗
7:	10.5	↘
8:	10.5	←
9:	10.2	↗
10:	10.4	↘

Serie	99 (1x)
Total	99 (1x)

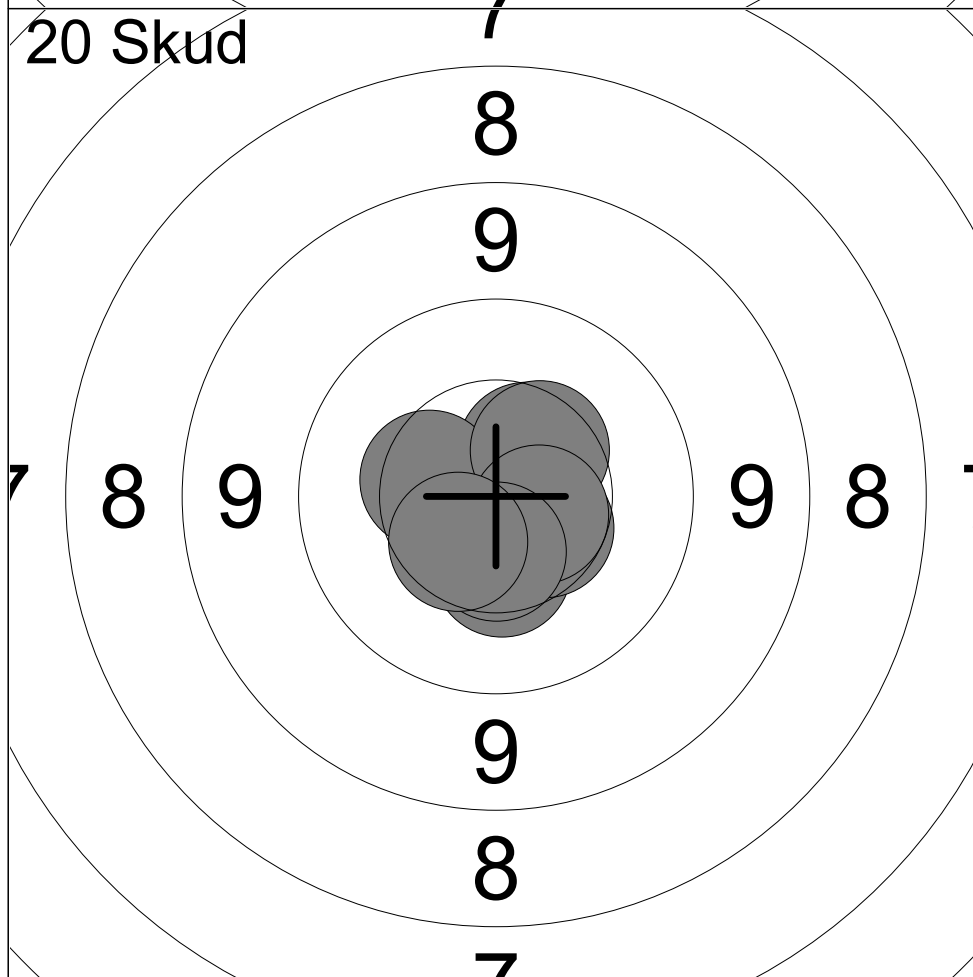

11:	10.5	↗
12:	10.8x	↘
13:	10.7x	↗
14:	10.4	↘
15:	10.4	←
16:	10.5	↘
17:	10.5	↗
18:	10.6	↘
19:	10.5	↘
20:	10.5	↘

Serie	100 (2x)
Total	199 (3x)

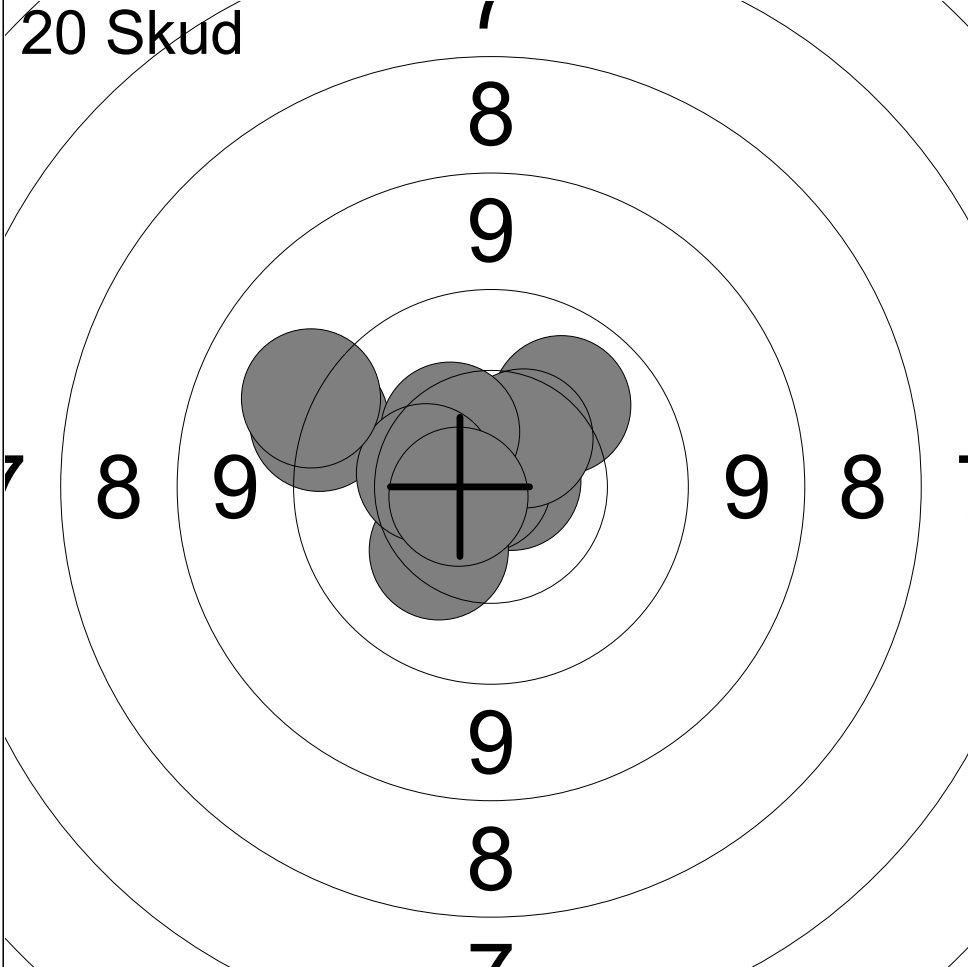

1:	10.8x	→
2:	10.9x	←
3:	10.3	↙
4:	10.1	↗
5:	10.5	↗
6:	9.5	←
7:	10.4	↗
8:	10.4	←
9:	9.3	↖
10:	10.7x	←

Serie	98 (3x)
Total	98 (3x)

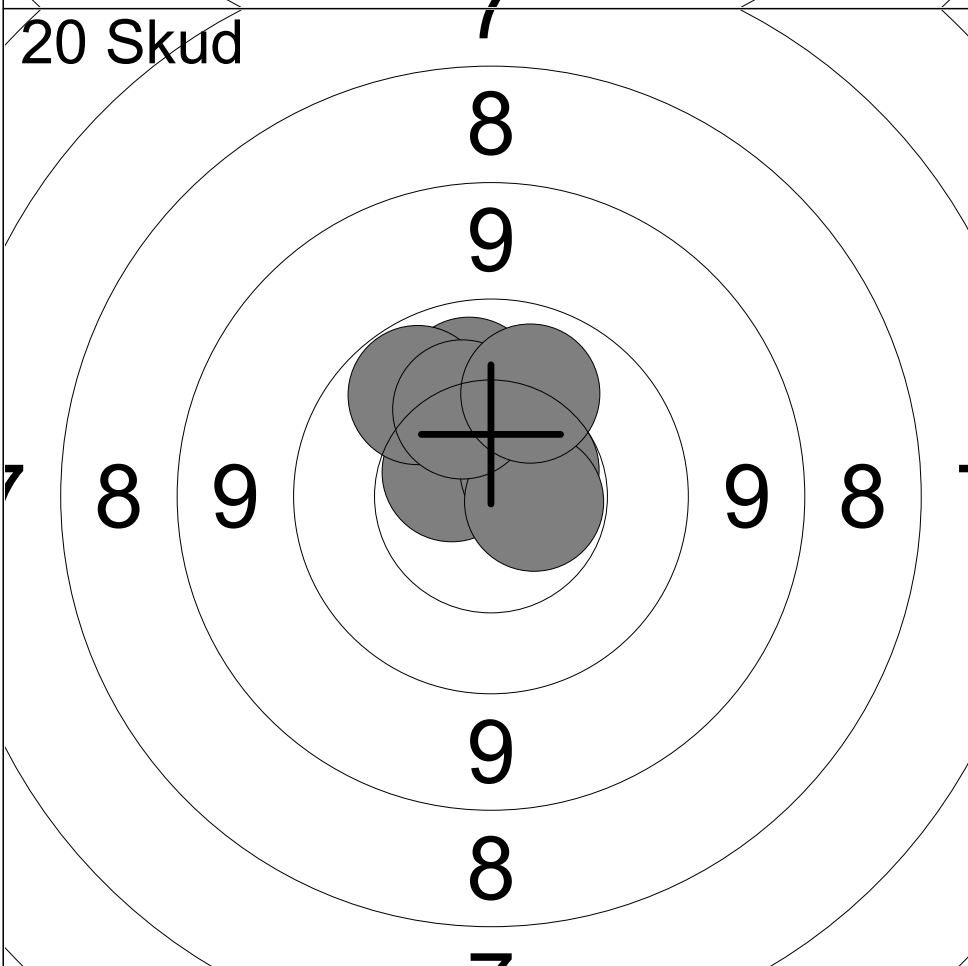

11:	10.2	↗
12:	10.4	↗
13:	10.2	↗
14:	10.6x	↖
15:	10.1	↗
16:	10.6	↗
17:	10.0	↖
18:	10.6x	→
19:	10.2	↗
20:	10.1	↗

Serie	100 (2x)
Total	198 (5x)

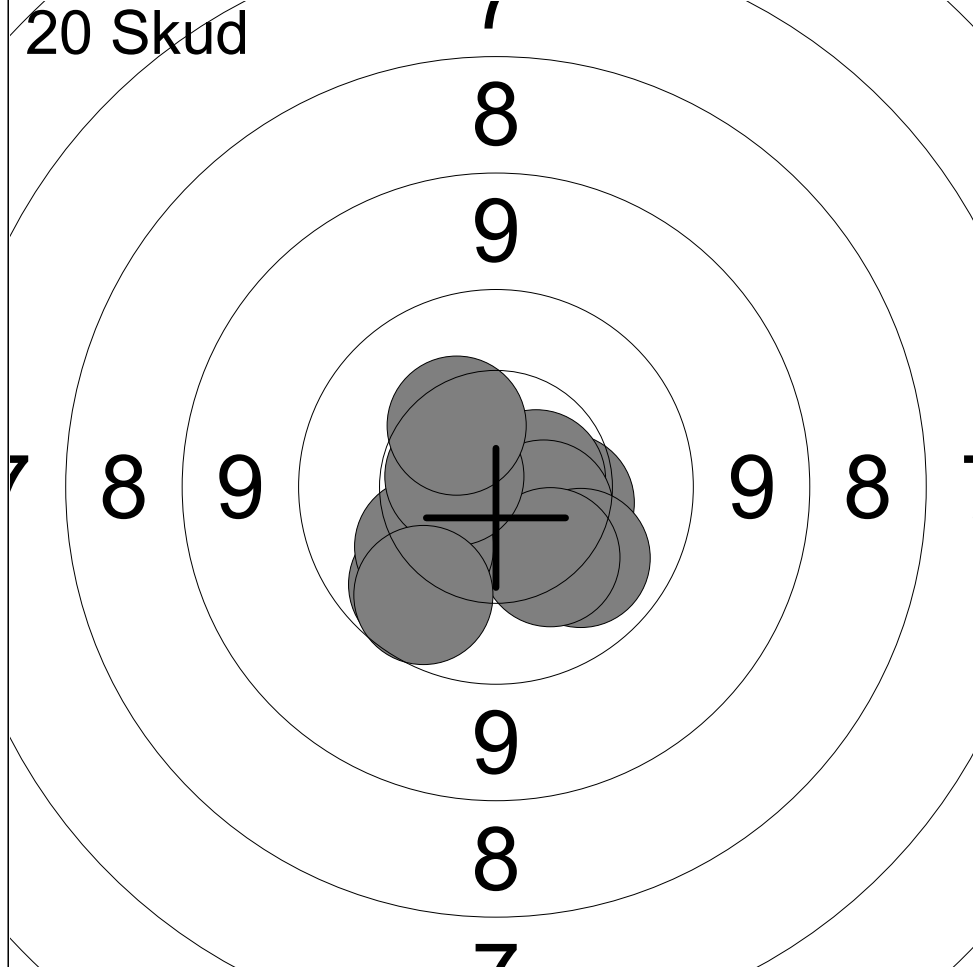

1:	10.0	↙
2:	10.4	→
3:	10.6x	→
4:	10.5	↘
5:	10.1	↘
6:	10.3	↘
7:	10.2	↙
8:	10.6x	←
9:	9.9	↘
10:	10.4	↗

Serie	99 (2x)
Total	99 (2x)

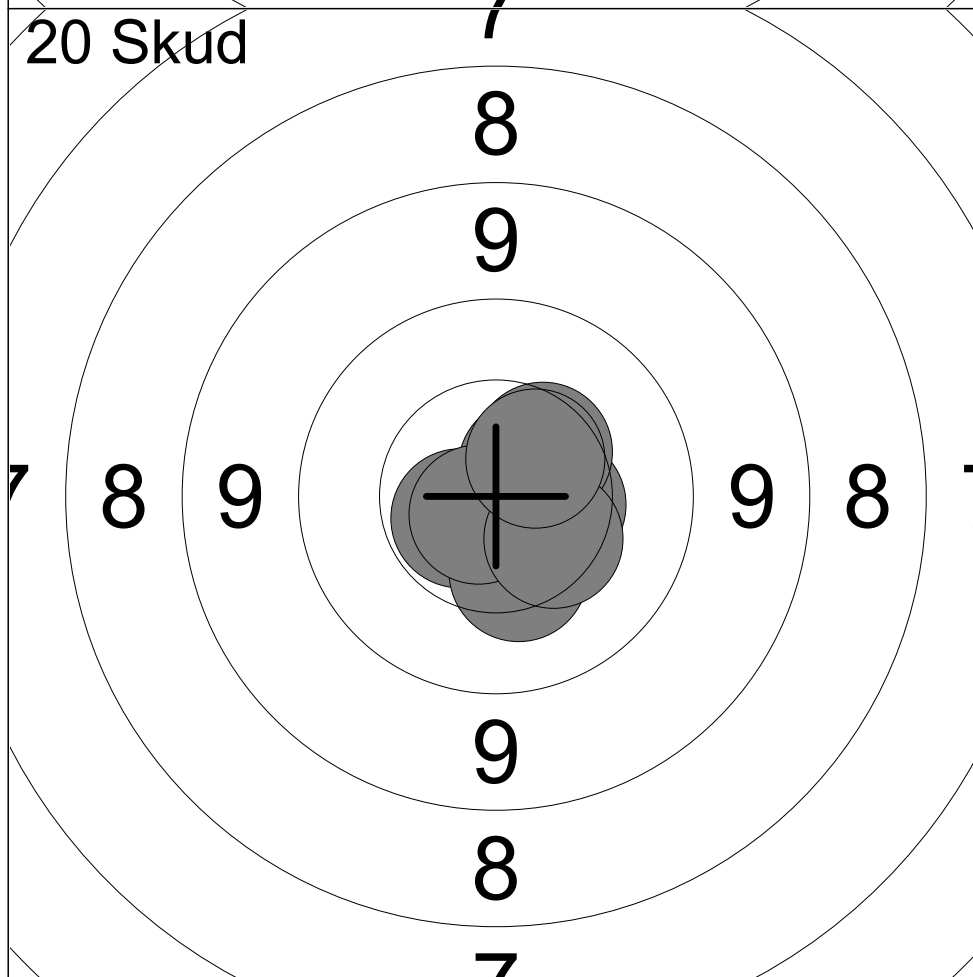

11:	10.6x	↙
12:	10.5	→
13:	10.4	↗
14:	10.6	↘
15:	10.7x	↘
16:	10.6x	↗
17:	10.3	↘
18:	10.8x	↙
19:	10.4	↘
20:	10.5	↗

Serie	100 (4x)
Total	199 (6x)

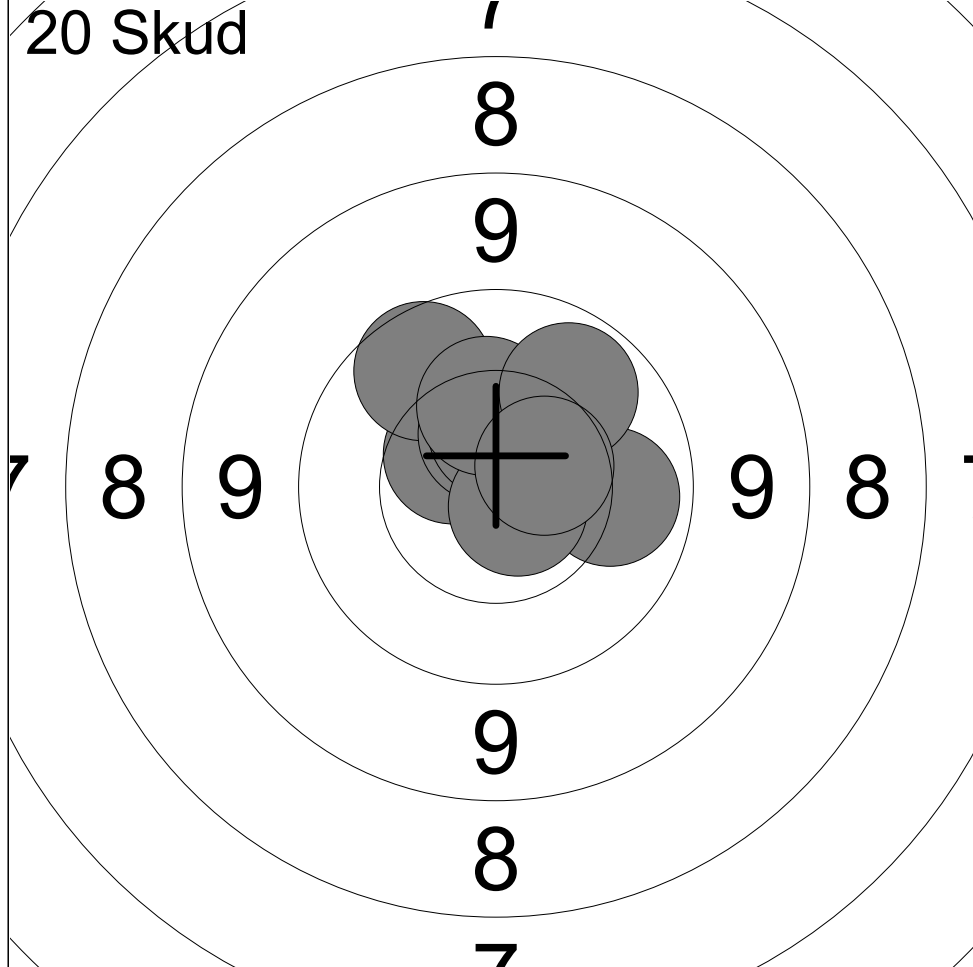

1:	10.1	→
2:	10.5	↗
3:	9.9	↗
4:	10.6	↗
5:	10.5	↑
6:	10.5	↑
7:	10.7x	↘
8:	10.3	↑
9:	10.0	↗
10:	10.5	↗

Serie	99 (1x)
Total	99 (1x)

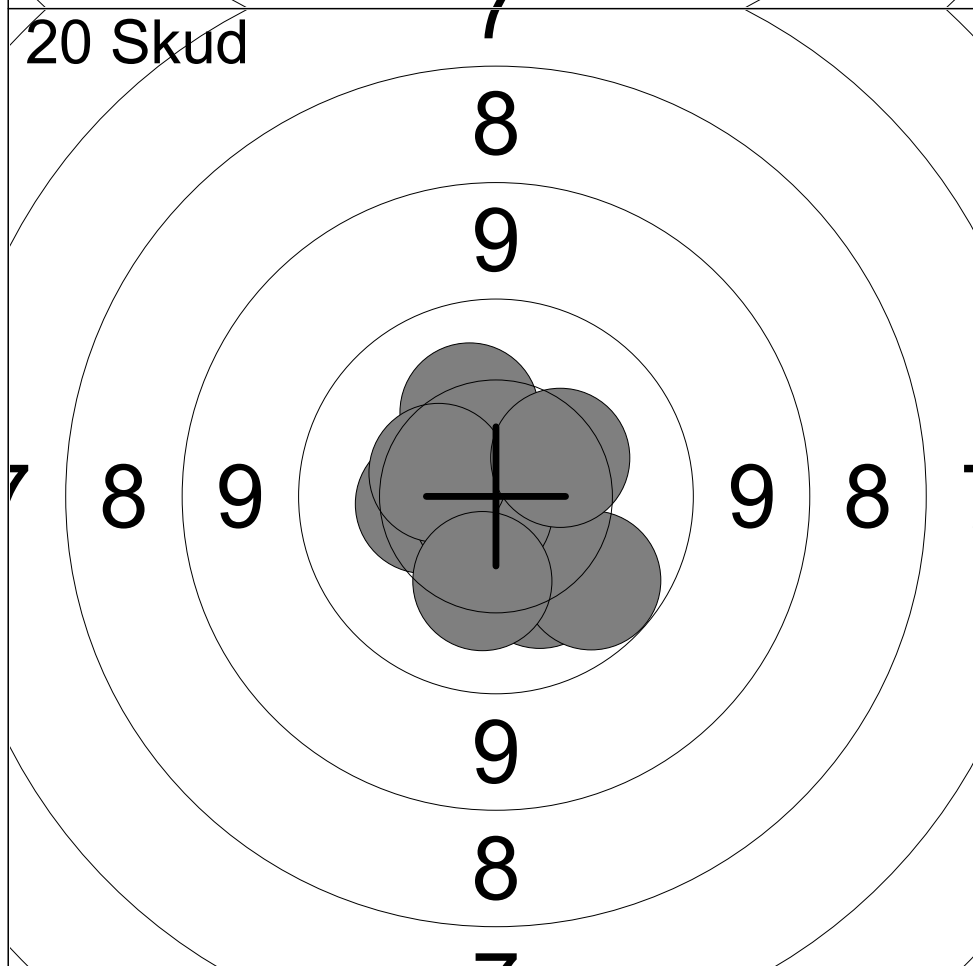

11:	10.5	↘
12:	10.4	←
13:	10.3	↑
14:	10.2	↘
15:	10.8x	↘
16:	10.0	↘
17:	10.8x	↘
18:	10.5	↗
19:	10.3	↘
20:	10.4	↗

Serie	100 (2x)
Total	199 (3x)

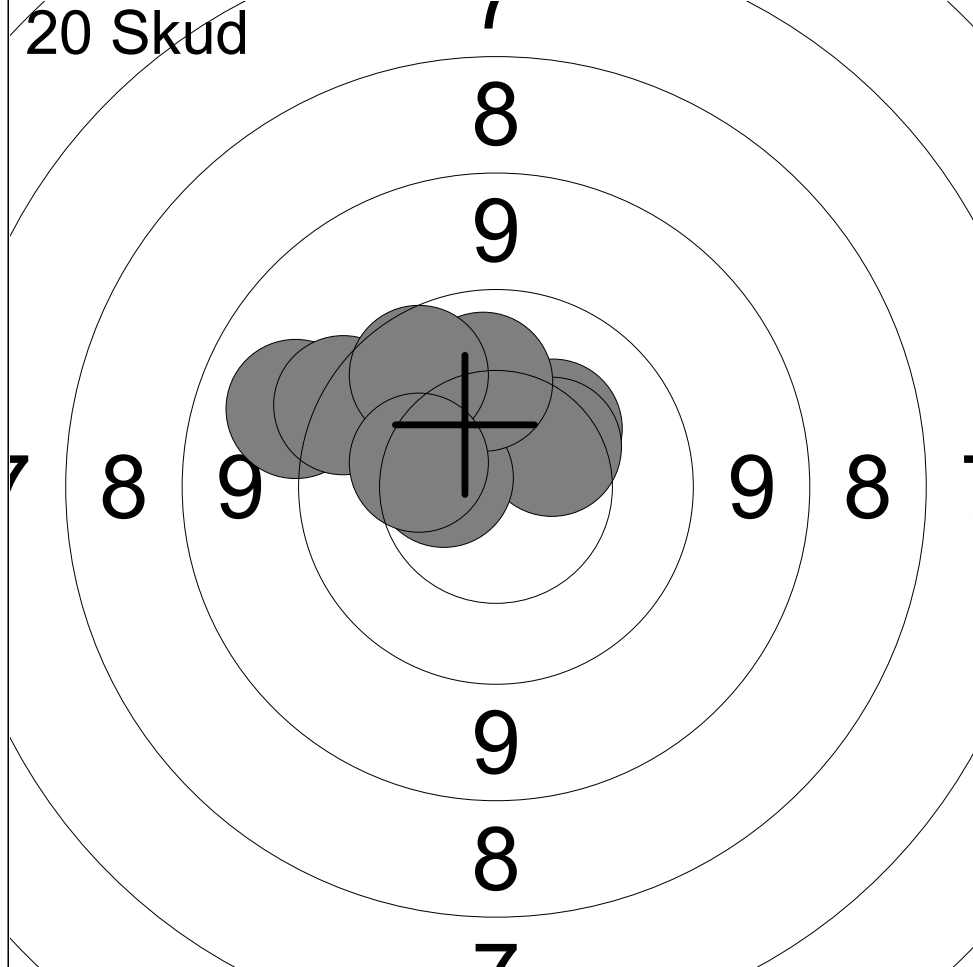

1:	10.3	↖
2:	10.3	↗
3:	10.4	↗
4:	9.2	↖
5:	10.1	↗
6:	10.5	↖
7:	9.6	↗
8:	10.1	↑
9:	9.9	↗
10:	10.3	↖

Serie	97 (0x)
Total	97 (0x)

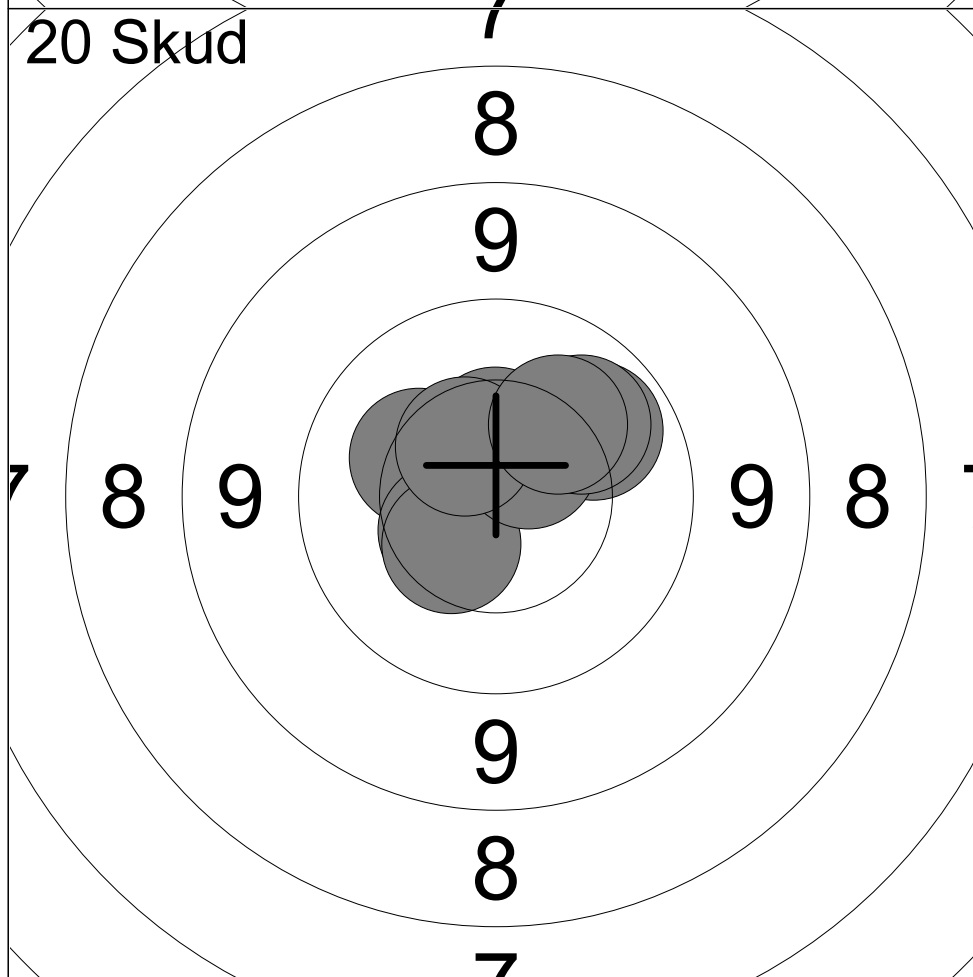

11:	10.3	↖
12:	10.7x	↗
13:	10.5	↑
14:	10.5	↖
15:	10.0	↗
16:	10.4	↖
17:	10.6	↗
18:	10.5	↖
19:	10.1	↗
20:	10.2	↗

Serie	100 (1x)
Total	197 (1x)

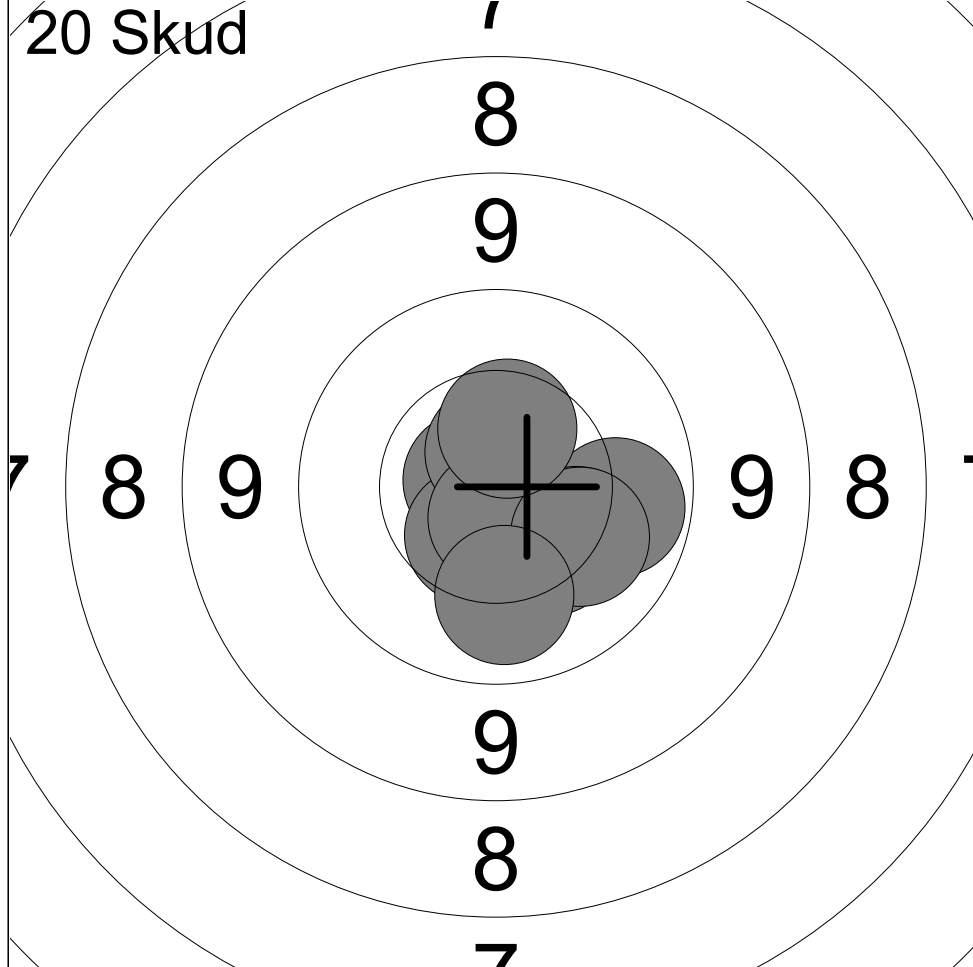

1:	10.8x	↖
2:	10.0	↗
3:	10.2	↘
4:	10.5	↙
5:	10.7x	↕
6:	10.3	↘
7:	10.7x	↓
8:	10.2	↘
9:	10.5	↕
10:	10.1	↓

Serie	100 (3x)
Total	100 (3x)

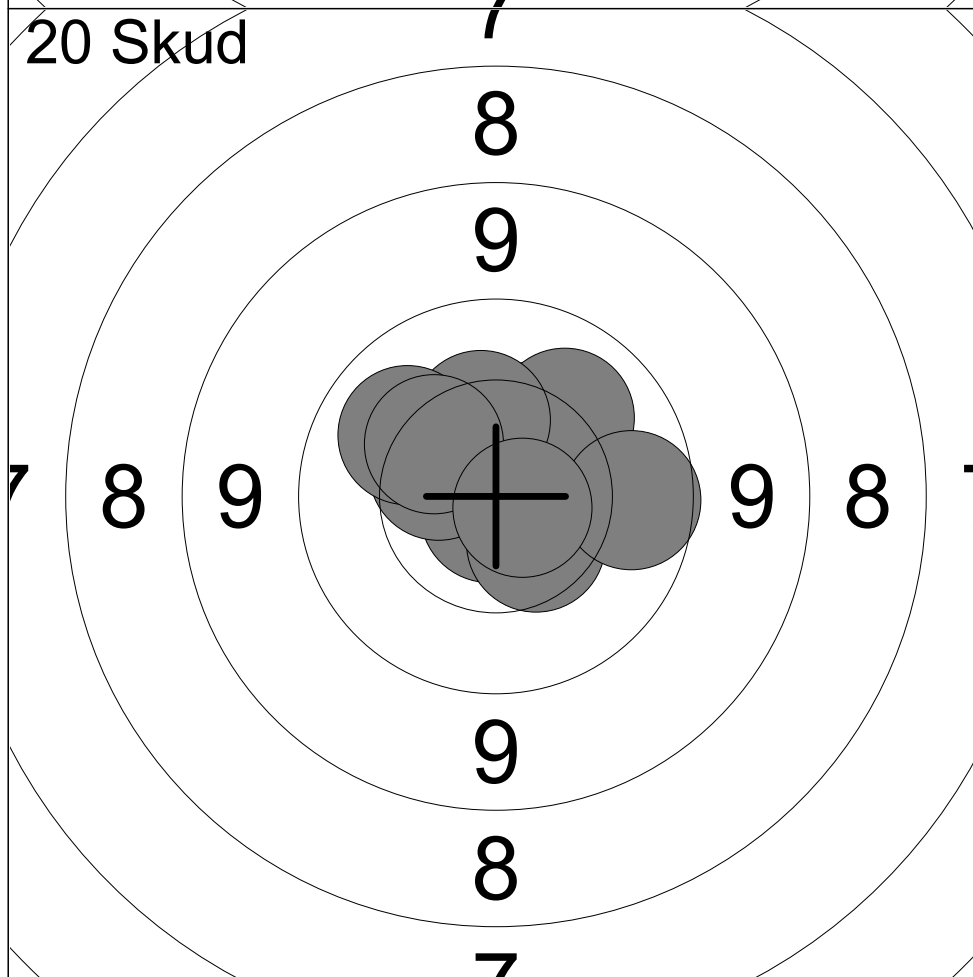

11:	10.8x	↙
12:	10.4	↗
13:	10.1	↗
14:	10.5	↘
15:	10.3	↕
16:	10.5	↗
17:	9.9	↗
18:	10.1	↗
19:	10.3	↗
20:	10.7x	↘

Serie	99 (2x)
Total	199 (5x)

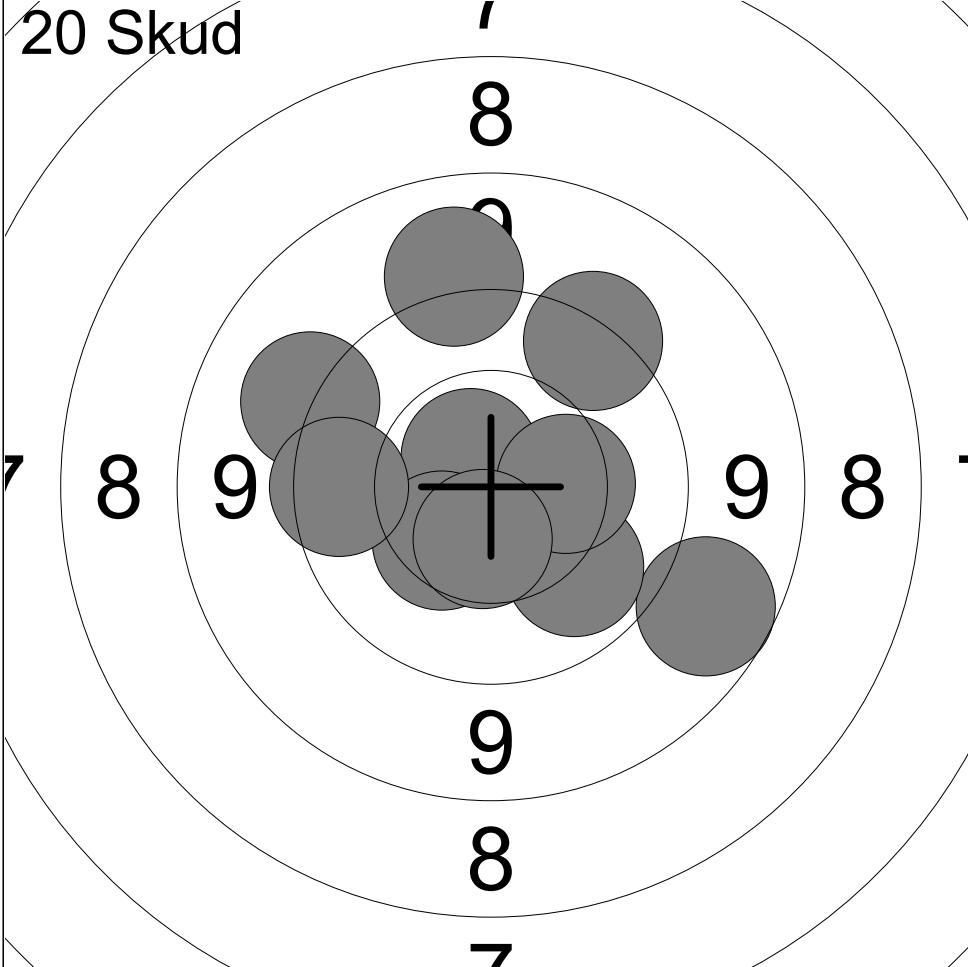

1:	9.5	↗
2:	8.9	↘
3:	10.0	↘
4:	10.7x	↗
5:	9.2	↗
6:	10.4	↖
7:	10.4	→
8:	10.5	↘
9:	9.3	↖
10:	9.7	←

Serie	94 (1x)
Total	94 (1x)

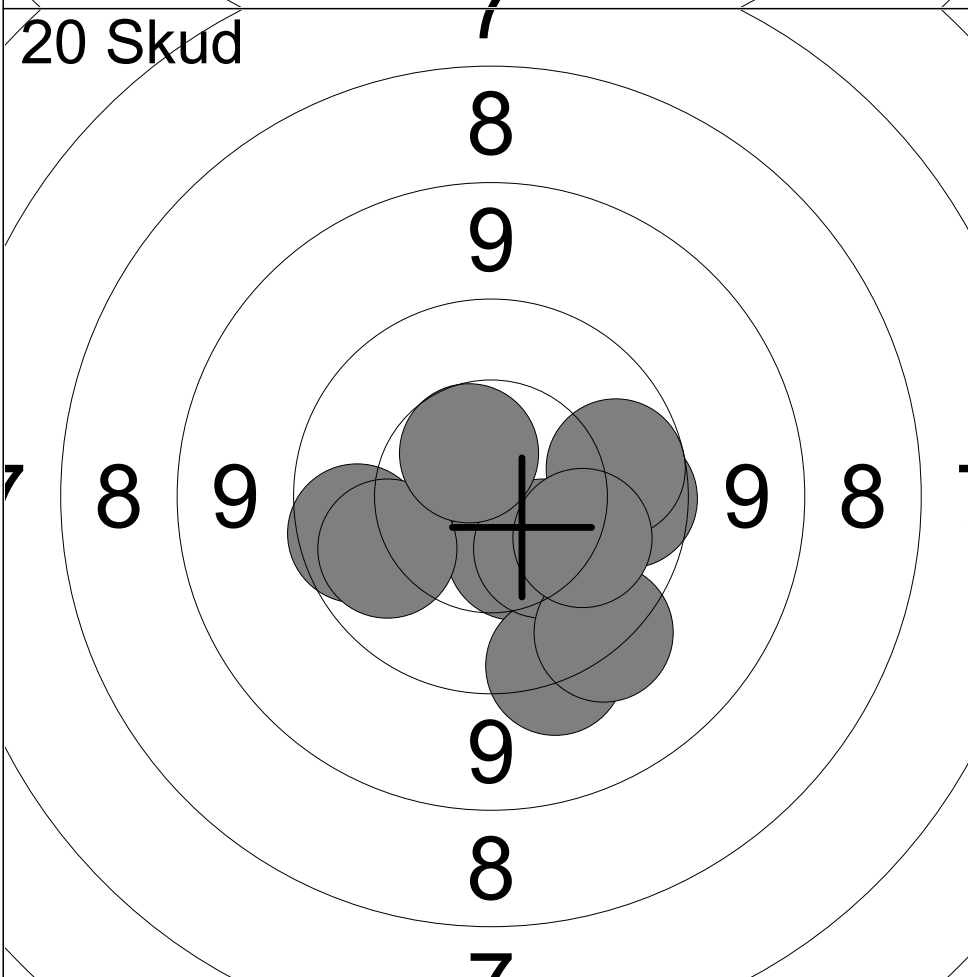

11:	9.9	←
12:	10.5	↘
13:	9.5	↘
14:	10.4	↘
15:	10.0	↖
16:	9.9	→
17:	9.9	↗
18:	9.5	↘
19:	10.6	↗
20:	10.2	↘

Serie	95 (0x)
Total	189 (1x)

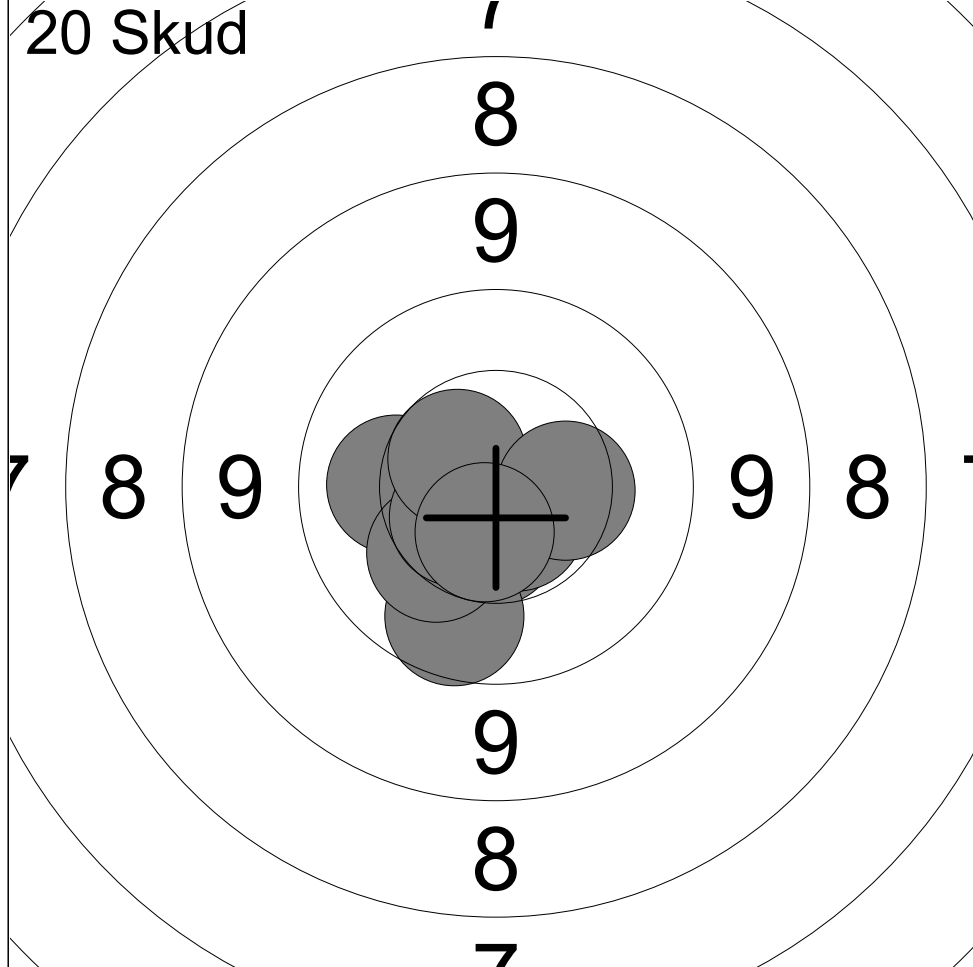

1:	10.2	←
2:	10.6	↓
3:	10.6	↙
4:	9.9	↘
5:	10.6x	↘
6:	10.3	↙
7:	10.6	↙
8:	10.6	↖
9:	10.4	→
10:	10.6	↓

Serie	99 (1x)
Total	99 (1x)

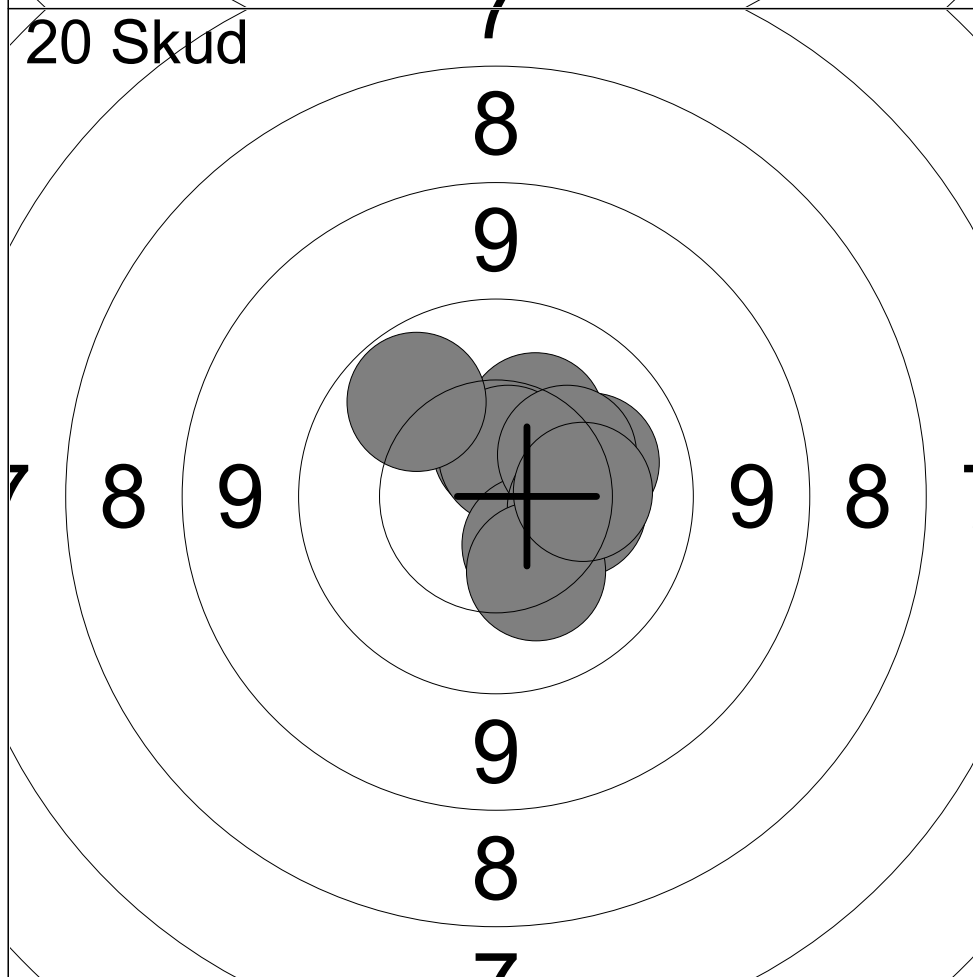

11:	10.6	↑
12:	10.2	→
13:	10.3	↗
14:	10.6x	↗
15:	10.5	↘
16:	10.3	↗
17:	10.3	→
18:	10.3	↘
19:	10.0	↗
20:	10.3	→

Serie	100 (1x)
Total	199 (2x)

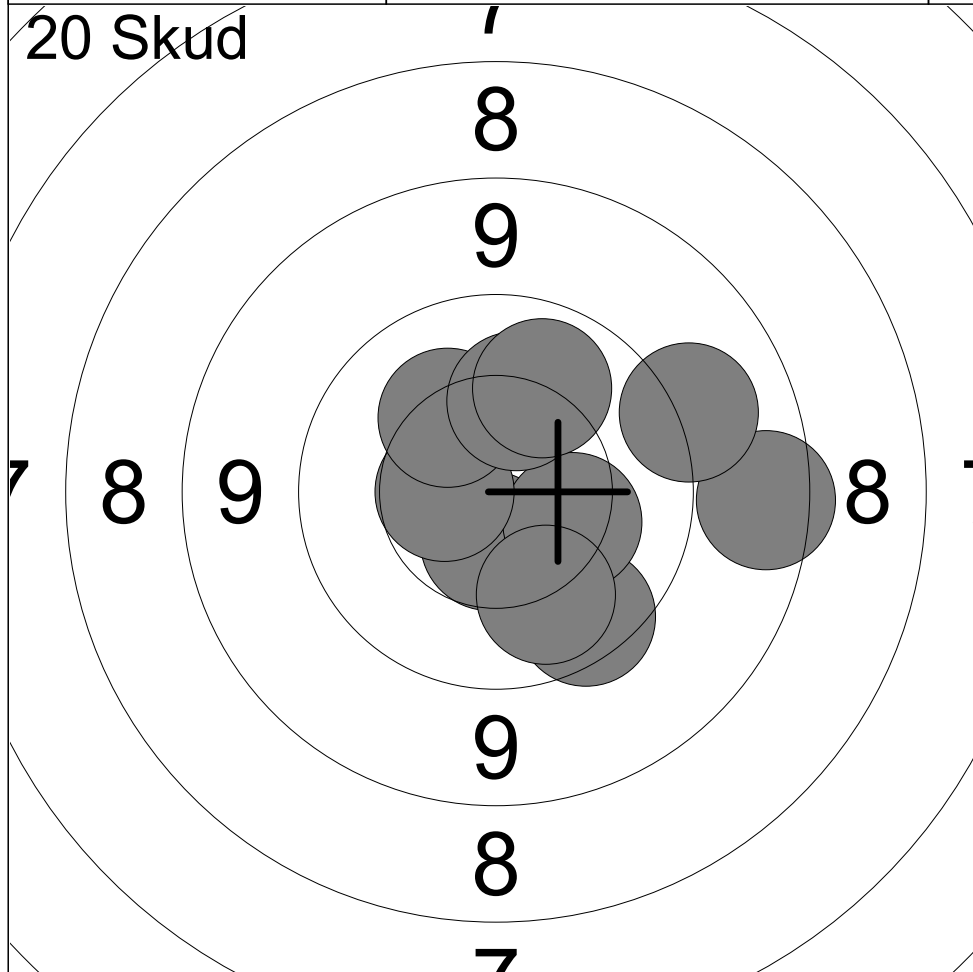

1:	9.7	↘
2:	8.7	→
3:	10.6	↘
4:	10.3	↘
5:	9.3	↗
6:	10.5	←
7:	10.1	↘
8:	10.3	↗
9:	10.2	↗
10:	10.1	↗

Serie	96 (0x)
Total	96 (0x)

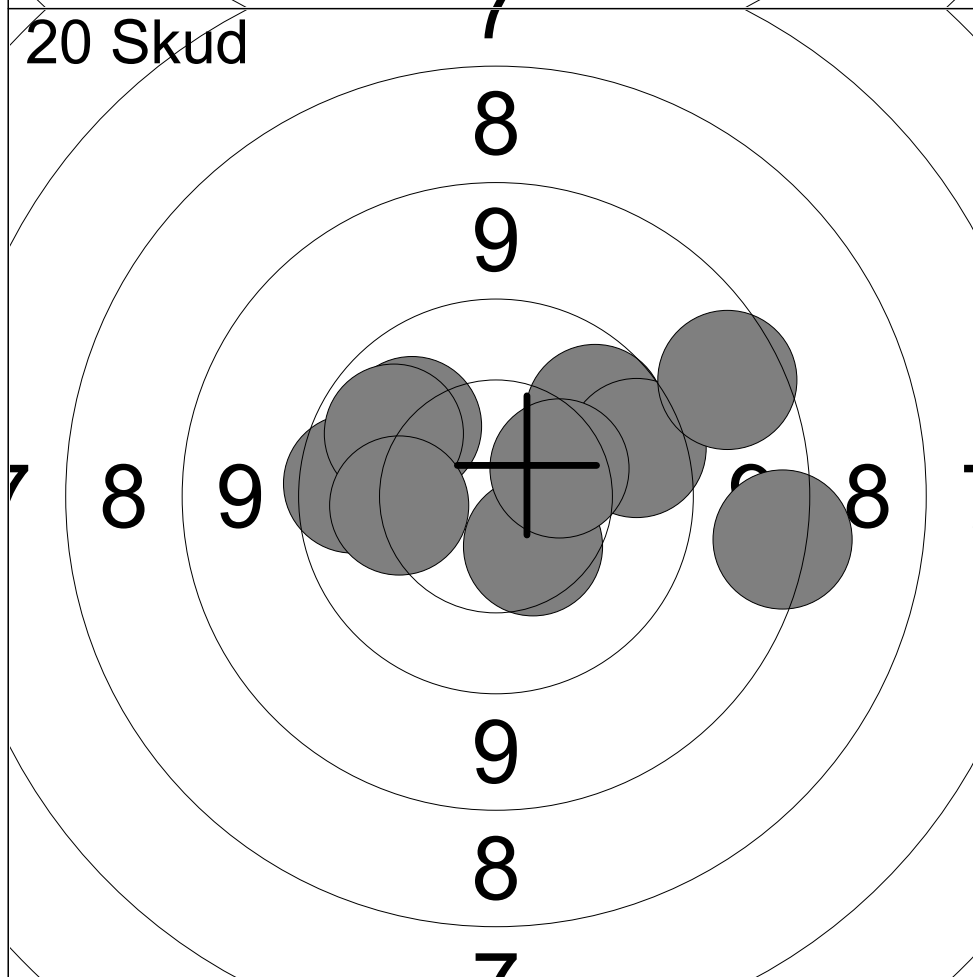

11:	10.5	↘
12:	9.9	↗
13:	8.6	→
14:	9.8	←
15:	10.1	↗
16:	10.0	↗
17:	9.8	↗
18:	10.2	←
19:	8.8	↗
20:	10.4	↗

Serie	93 (0x)
Total	189 (0x)

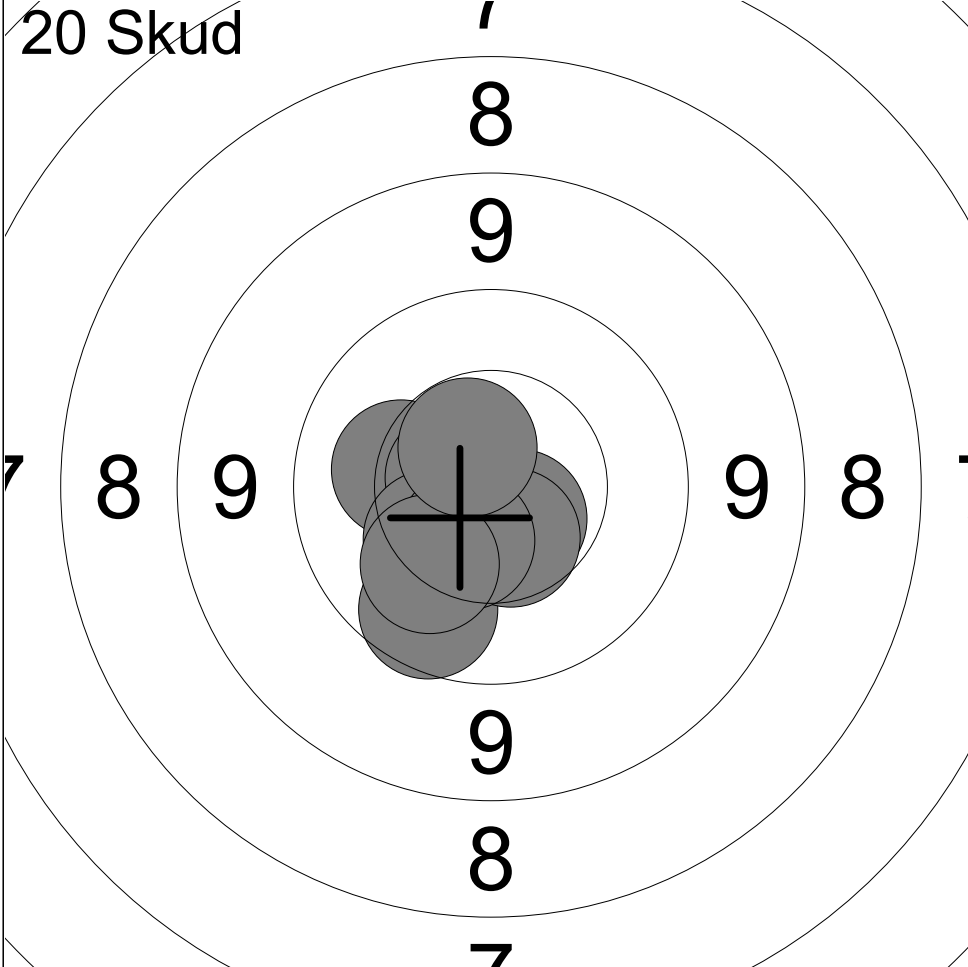

1:	10.7x	↙
2:	10.2	←
3:	10.6x	↘
4:	10.7x	←
5:	9.9	↘
6:	10.5	↘
7:	10.3	↙
8:	10.5	↘
9:	10.2	↙
10:	10.6x	↗

Serie	99 (4x)
Total	99 (4x)

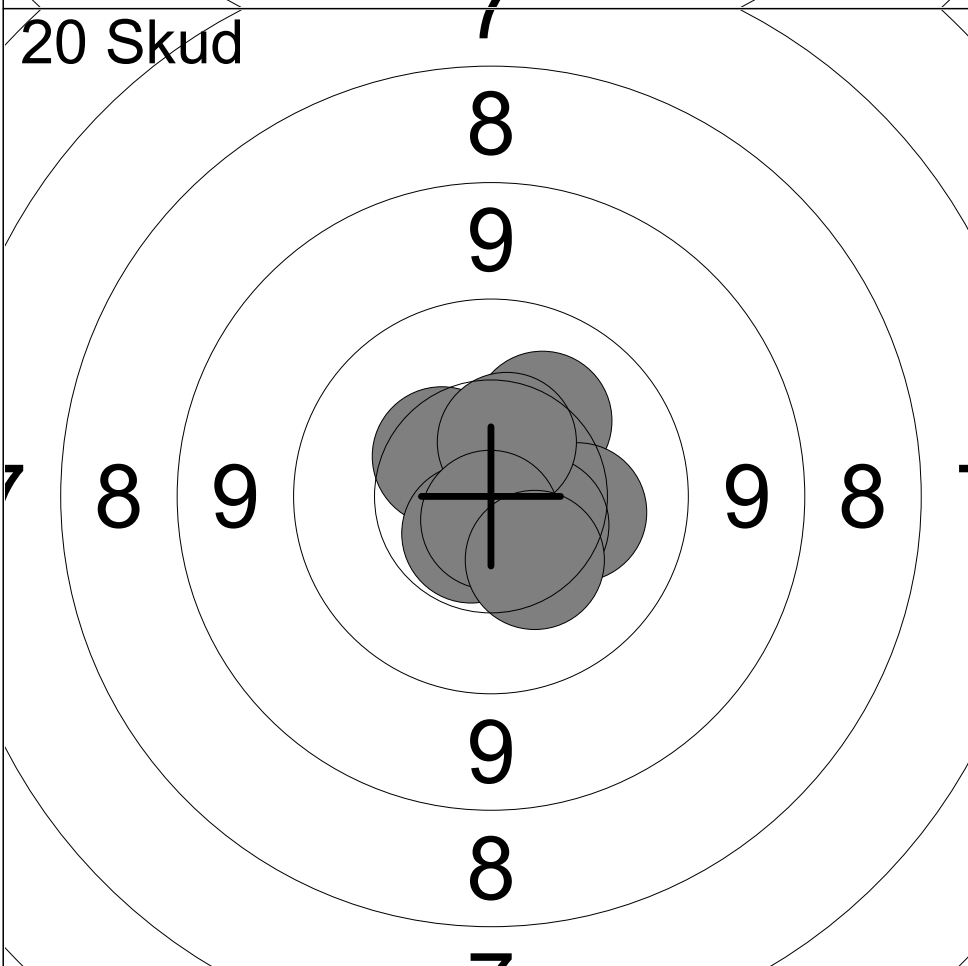

11:	10.5	↗
12:	10.6x	→
13:	10.2	↗
14:	10.7x	↘
15:	10.6x	↘
16:	10.3	→
17:	10.5	↘
18:	10.5	↗
19:	10.8x	↘
20:	10.3	↘

Serie	100 (4x)
Total	199 (8x)

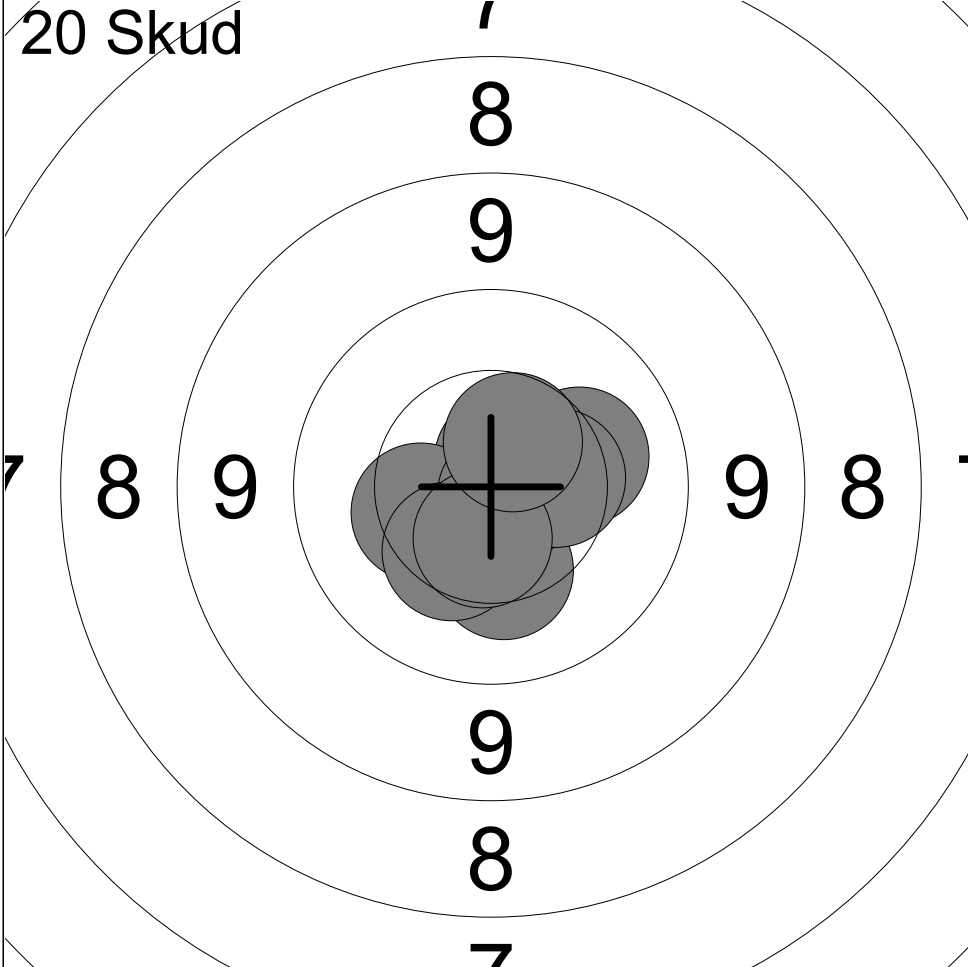

1:	10.4	↙
2:	10.3	↓
3:	10.7x	↗
4:	10.4	↖
5:	10.8x	↘
6:	10.2	↗
7:	10.4	→
8:	10.4	↙
9:	10.5	↓
10:	10.6	↗

Serie	100 (2x)
Total	100 (2x)

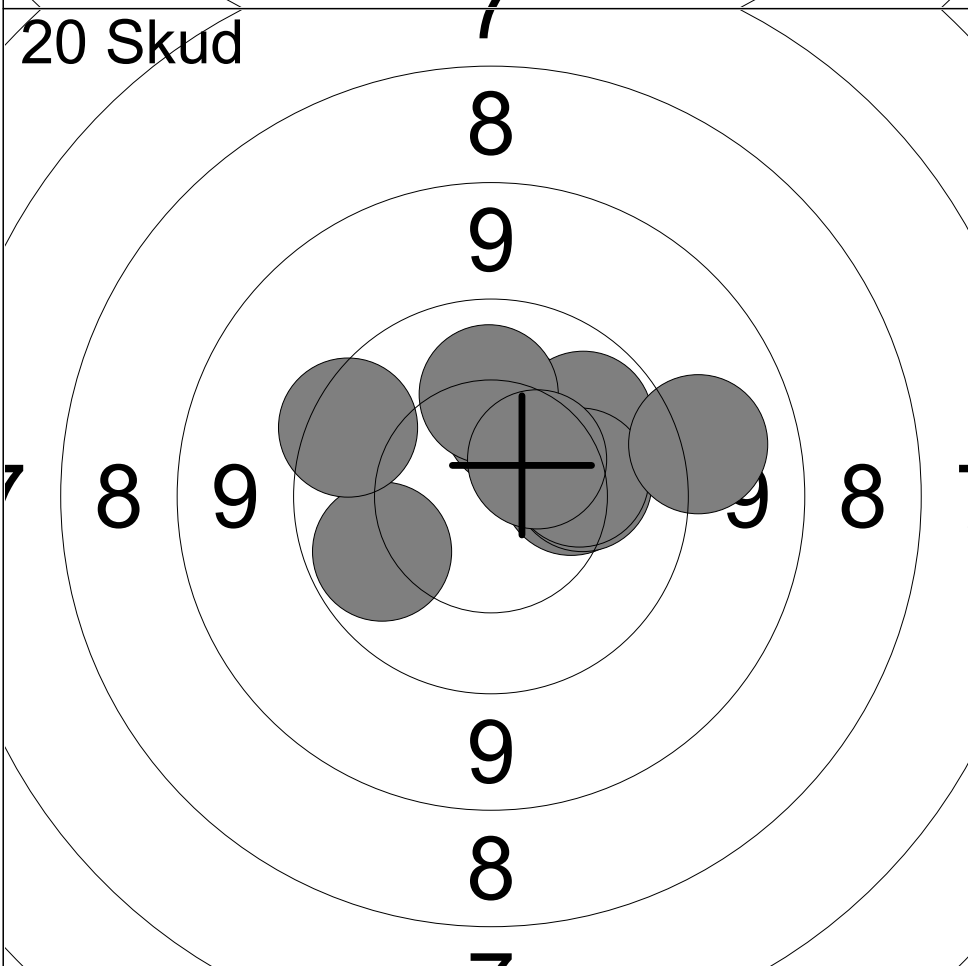

11:	10.3	↗
12:	10.0	↖
13:	10.3	→
14:	10.0	↗
15:	10.2	→
16:	9.7	↖
17:	10.2	→
18:	9.2	→
19:	10.2	↑
20:	10.5	↗

Serie	98 (0x)
Total	198 (2x)

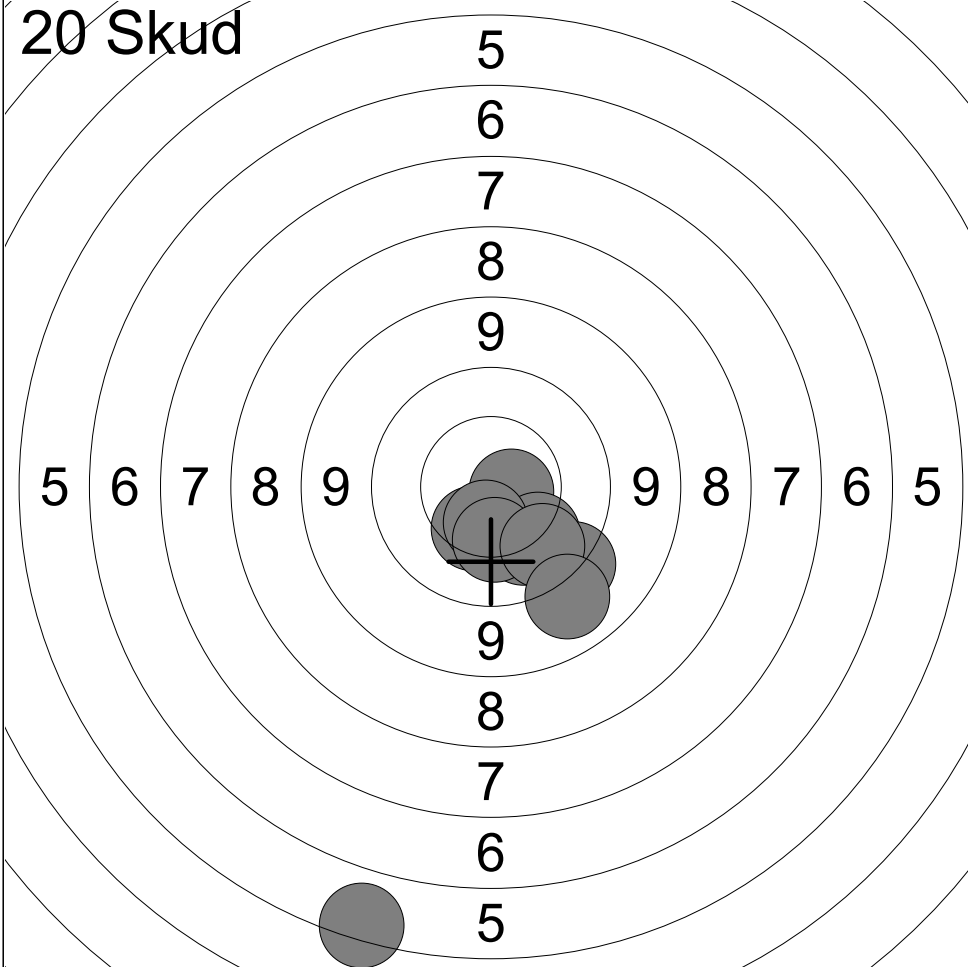

1:	10.1	↘
2:	10.7x	→
3:	10.1	↘
4:	10.4	↘
5:	4.6	↘
6:	10.5	↘
7:	10.3	↘
8:	9.4	↘
9:	9.9	↘
10:	9.2	↘

Serie	91 (1x)
Total	91 (1x)

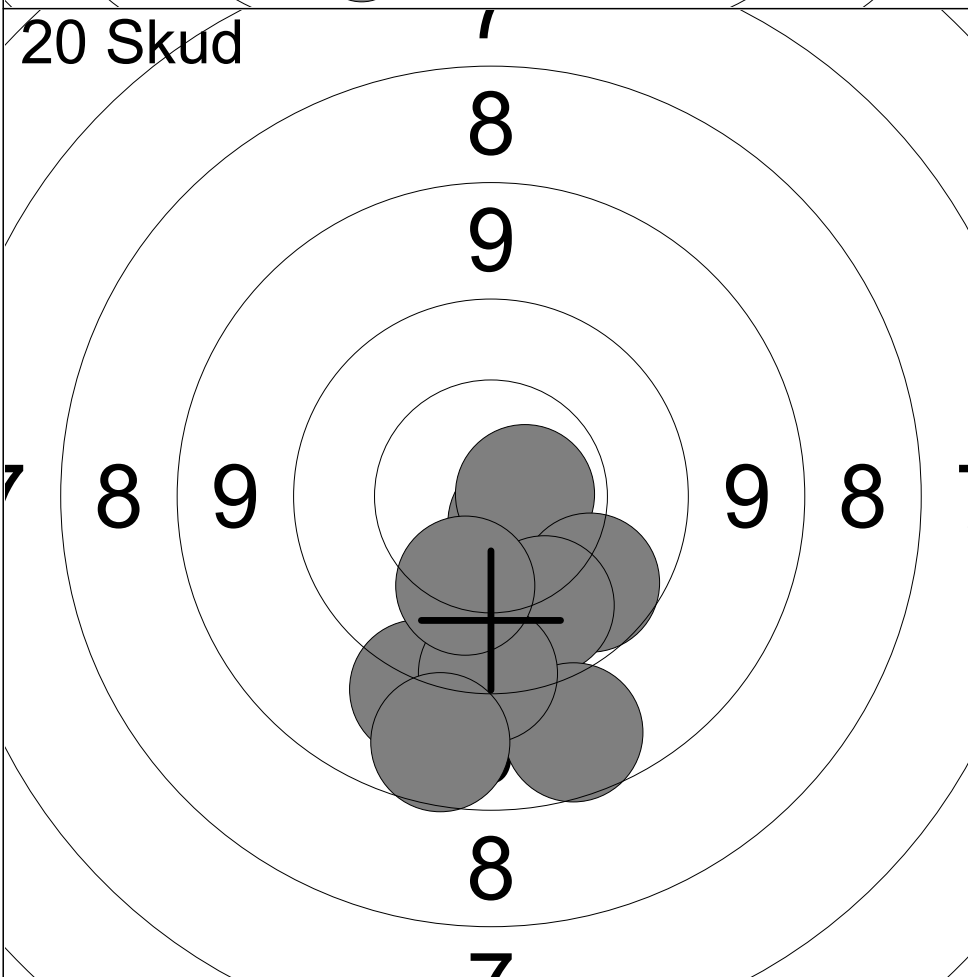

11:	9.7	↓
12:	10.7x	↘
13:	10.7x	→
14:	9.3	↘
15:	9.9	↘
16:	10.0	↘
17:	8.9	↘
18:	9.5	↓
19:	8.9	↘
20:	10.2	↘

Serie	92 (2x)
Total	183 (3x)

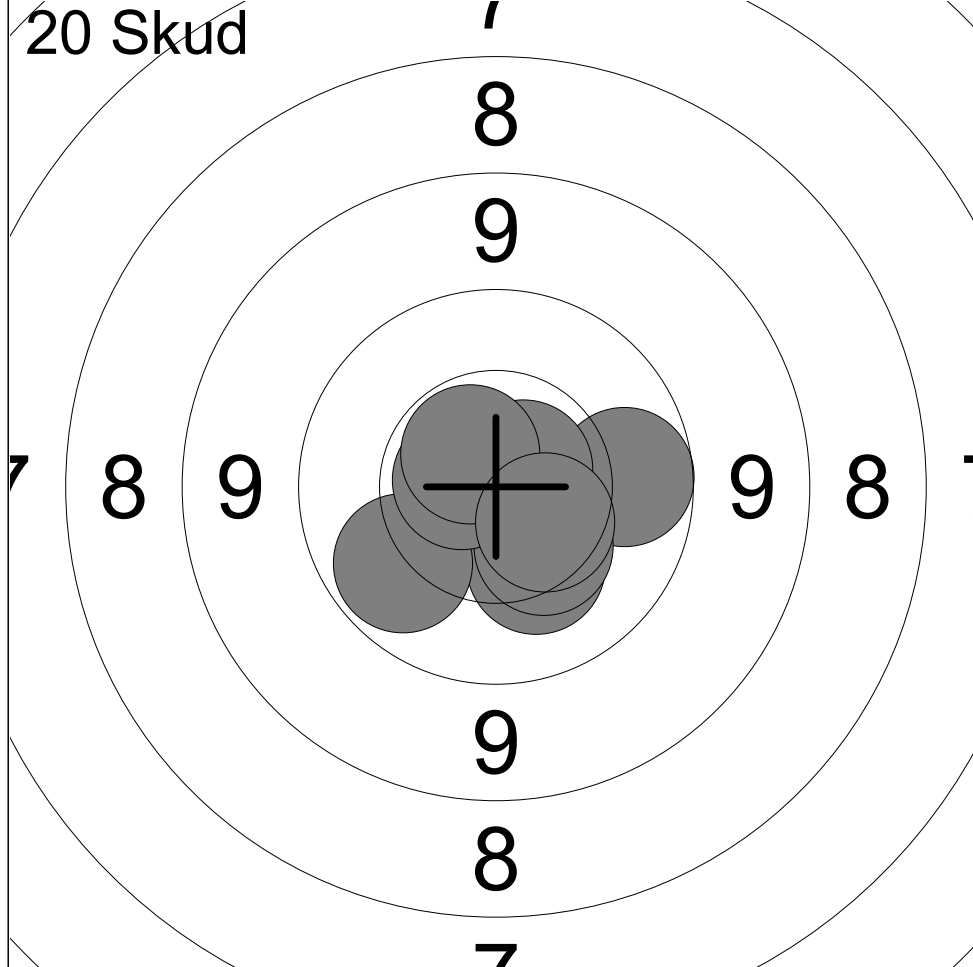

1:	10.9x	↙
2:	9.9	→
3:	10.7x	↗
4:	10.6	↘
5:	10.3	↘
6:	10.4	↘
7:	10.0	↙
8:	10.7x	←
9:	10.6x	↗
10:	10.5	↘

Serie	99 (4x)
Total	99 (4x)

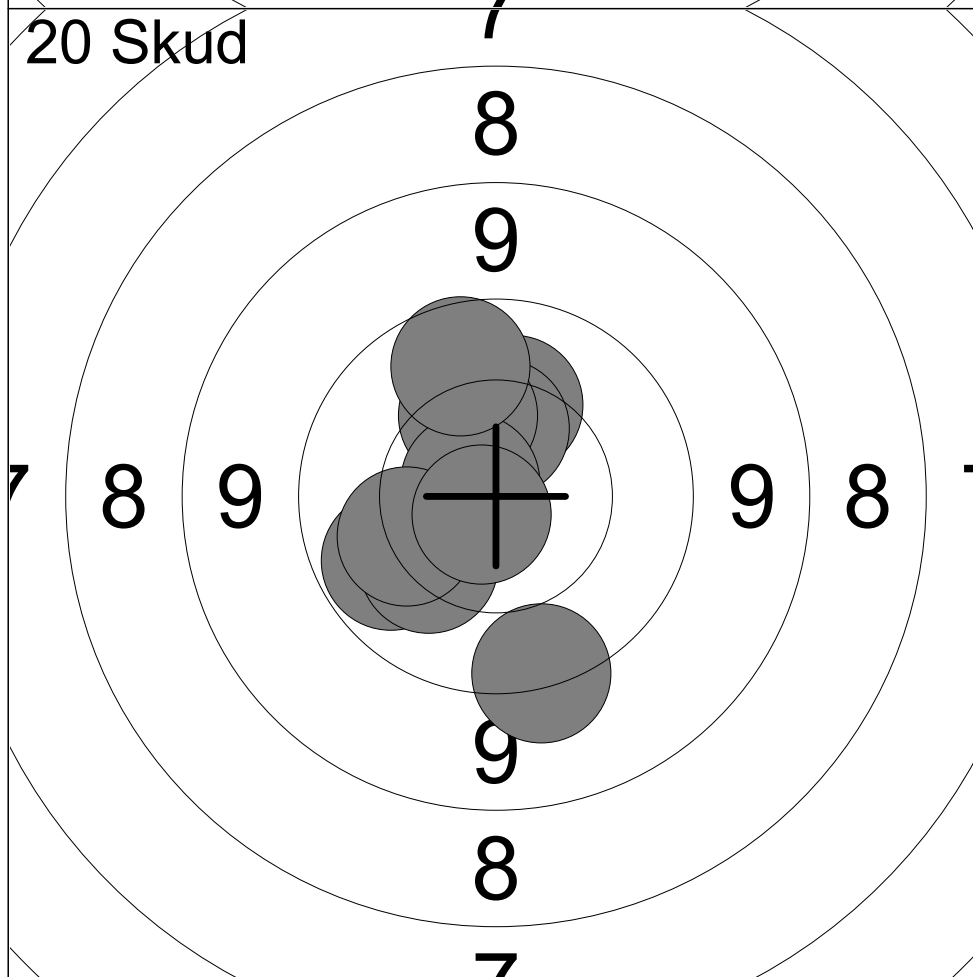

11:	10.2	↑
12:	10.4	↑
13:	10.3	↑
14:	10.0	↙
15:	10.7x	↖
16:	9.9	↑
17:	10.2	↙
18:	9.5	↘
19:	10.2	↙
20:	10.8x	↘

Serie	98 (2x)
Total	197 (6x)

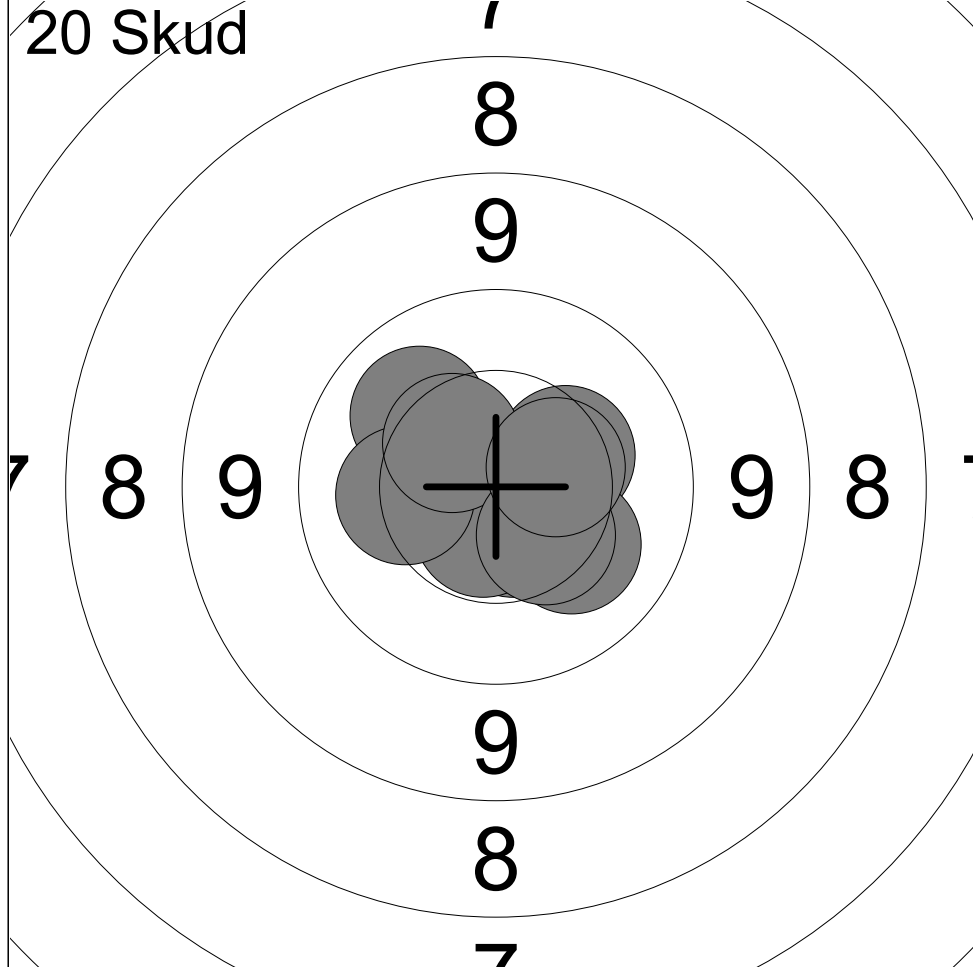

1:	10.4	↗
2:	10.7x	↘
3:	10.1	↗
4:	10.2	↘
5:	10.6x	↘
6:	10.6x	↘
7:	10.2	↖
8:	10.5	↗
9:	10.4	↘
10:	10.5	↗

Serie	100 (3x)
Total	100 (3x)

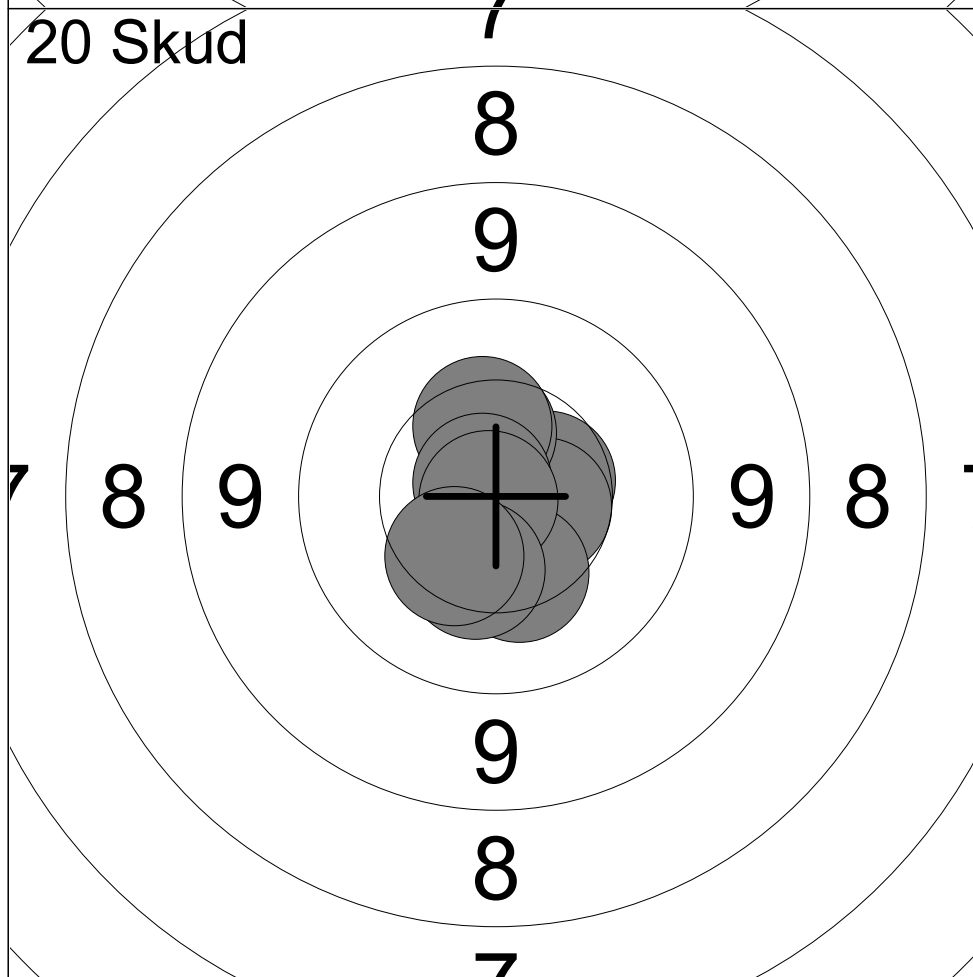

11:	10.7x	↘
12:	10.5	↗
13:	10.6	↗
14:	10.4	↗
15:	10.4	↗
16:	10.3	↘
17:	10.8x	↗
18:	10.9x	↖
19:	10.4	↘
20:	10.4	↘

Serie	100 (3x)
Total	200 (6x)

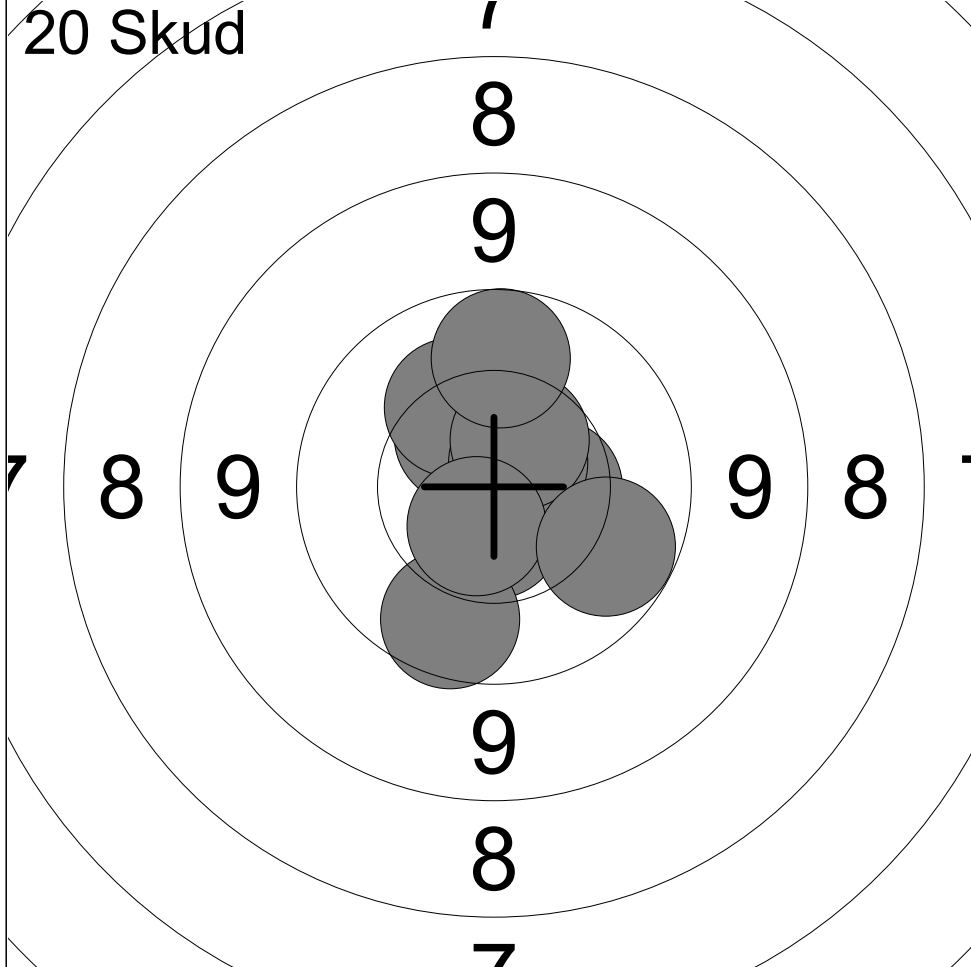

1:	10.5	↖
2:	10.5	→
3:	10.3	↖
4:	10.7x	↗
5:	10.6x	↓
6:	10.5	↗
7:	9.9	↑
8:	9.9	↘
9:	10.6x	↘
10:	10.0	↘

Serie	98 (3x)
Total	98 (3x)

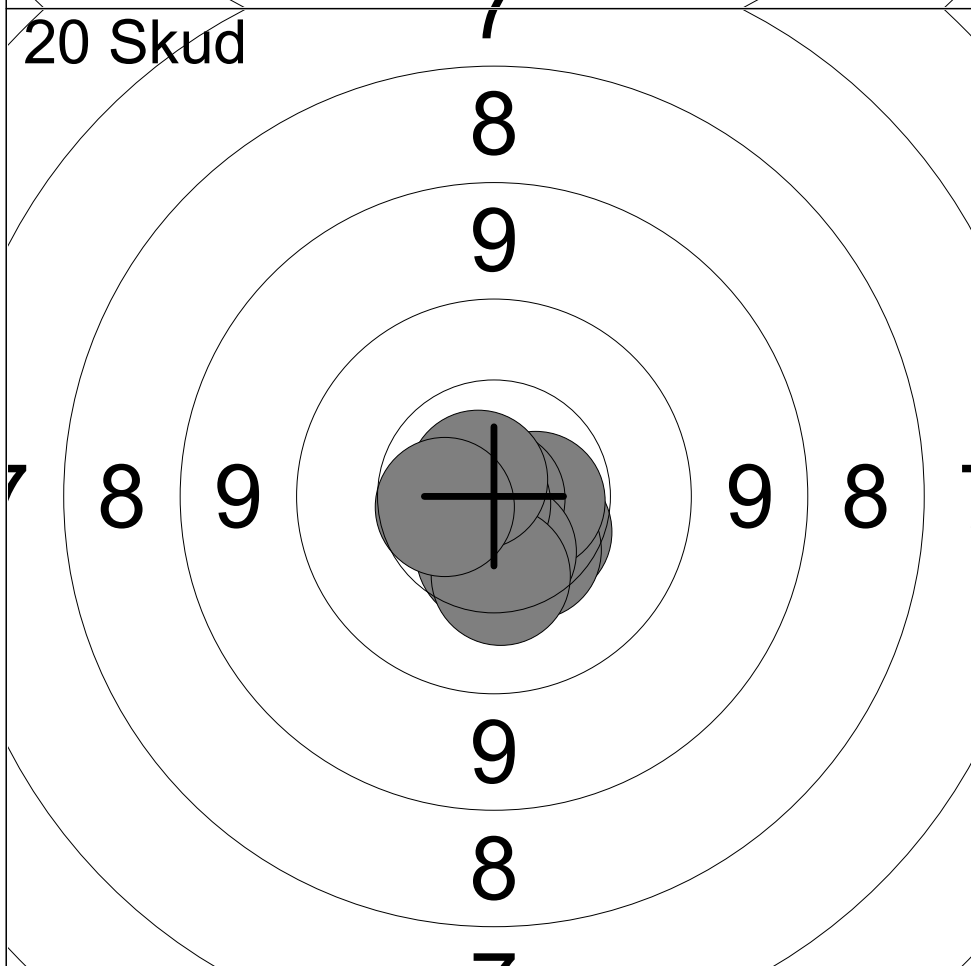

11:	10.5	↘
12:	10.5	↘
13:	10.4	↘
14:	10.6x	→
15:	10.9x	↘
16:	10.5	↘
17:	10.8x	↖
18:	10.3	↘
19:	10.8x	↗
20:	10.6	←

Serie	100 (4x)
Total	198 (7x)

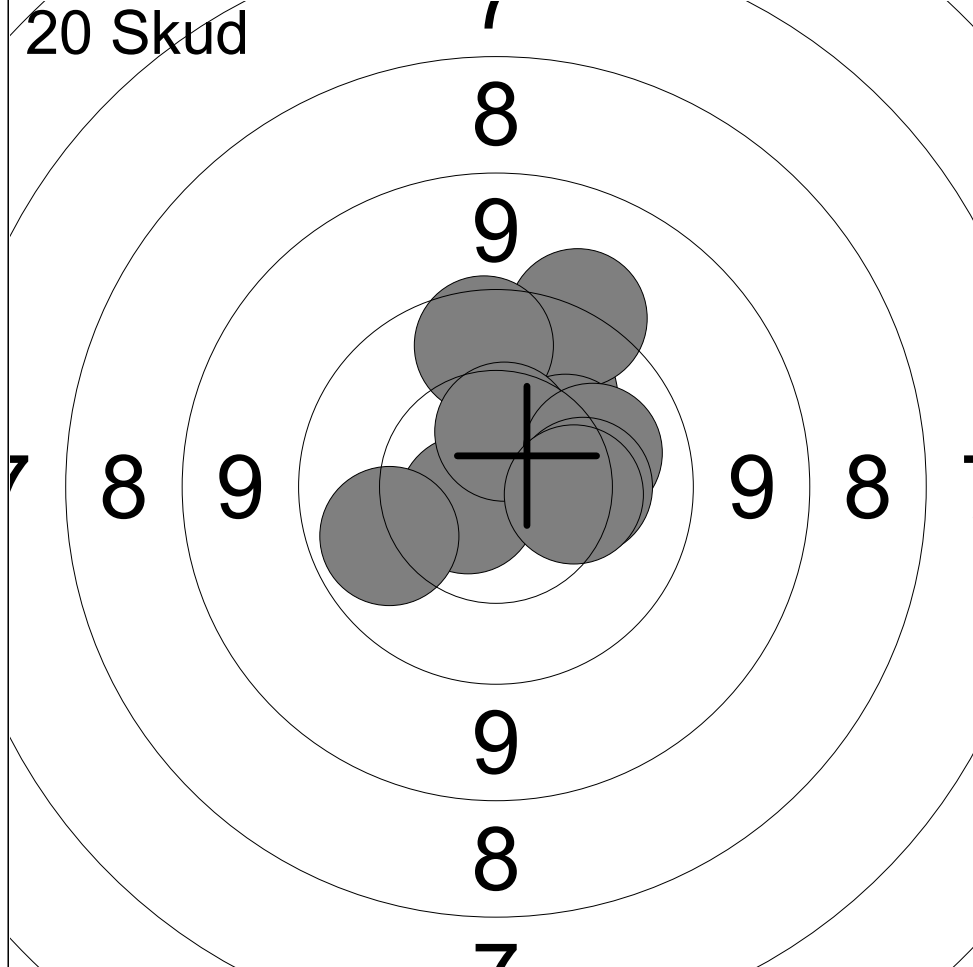

1:	10.1	↗
2:	9.4	↗
3:	10.7x	↖
4:	10.3	↗
5:	9.8	↑
6:	10.5	↑
7:	10.1	↗
8:	10.3	→
9:	10.0	↖
10:	10.3	→

Serie	98 (1x)
Total	98 (1x)

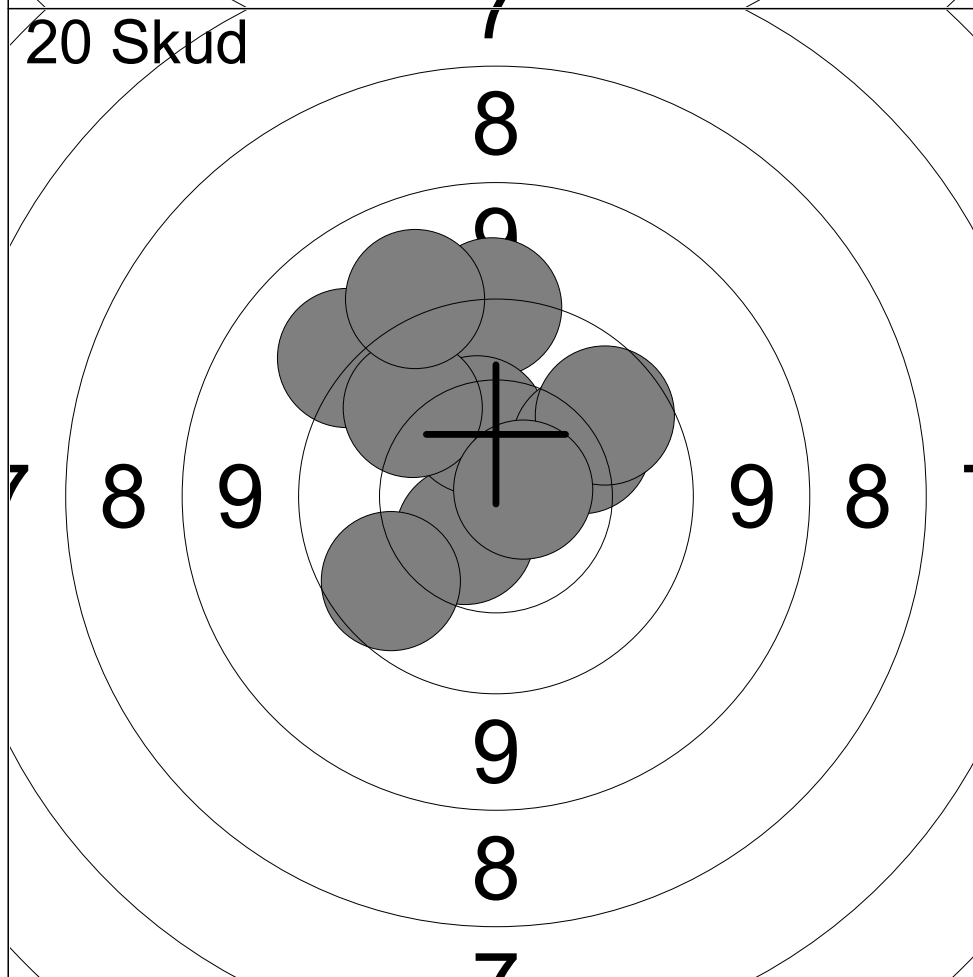

11:	9.4	↑
12:	10.6	↖
13:	9.3	↖
14:	10.4	↑
15:	10.2	↗
16:	10.0	↖
17:	9.2	↑
18:	9.9	↖
19:	9.9	↗
20:	10.7x	→

Serie	95 (1x)
Total	193 (2x)

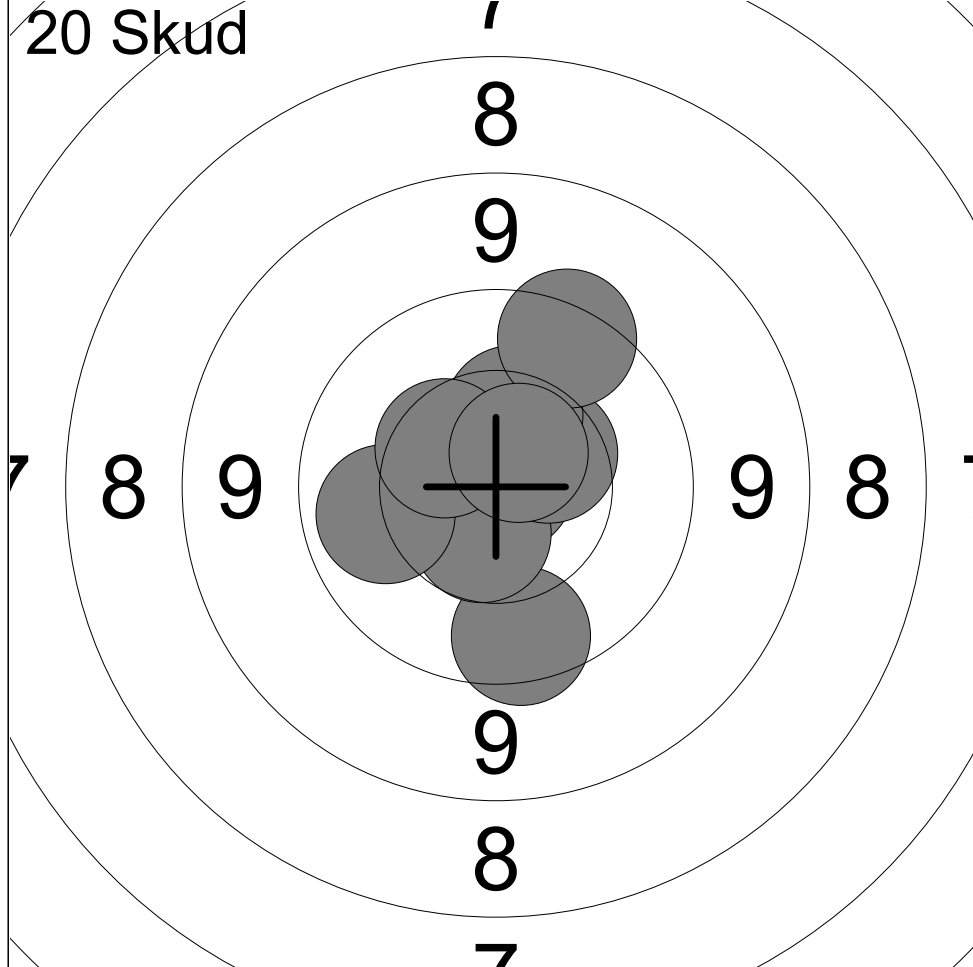

1:	9.8	↓
2:	10.9x	→
3:	10.6	↓
4:	10.1	←
5:	10.5	↗
6:	10.6x	↑
7:	10.4	↑
8:	10.4	↖
9:	9.6	↗
10:	10.6x	↗

Serie	98 (3x)
Total	98 (3x)

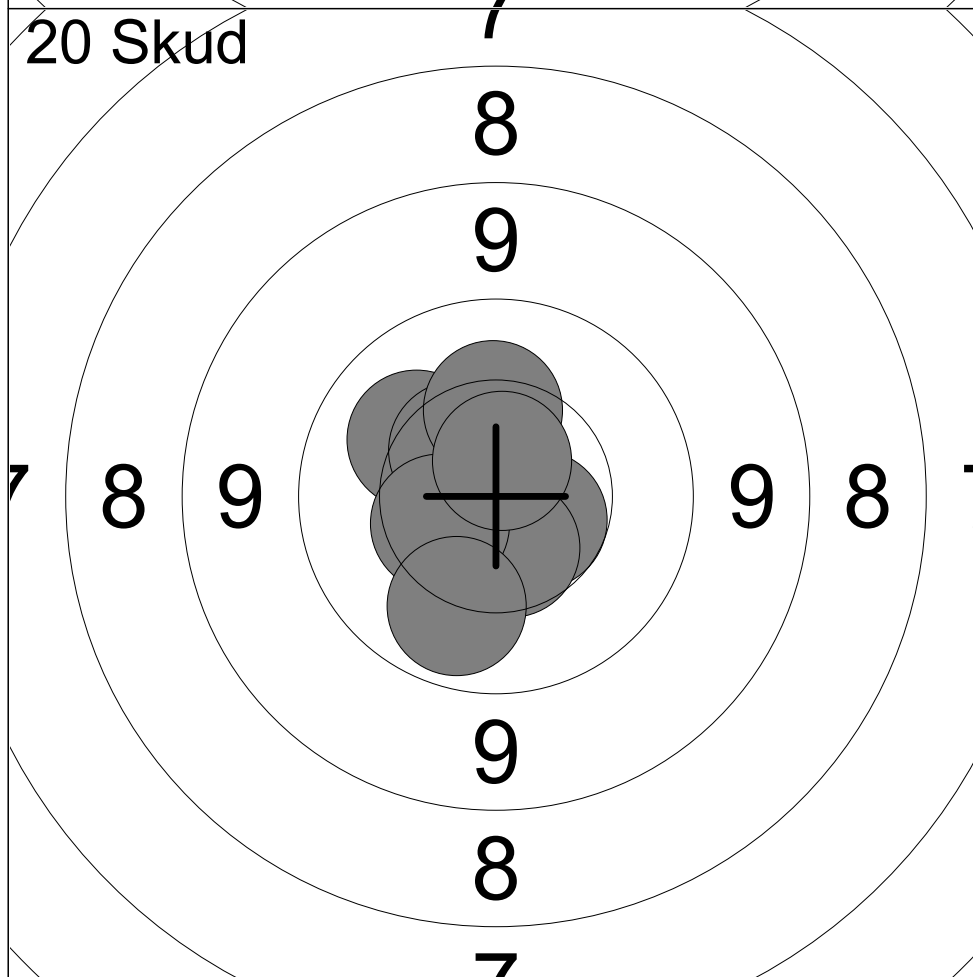

11:	10.2	↖
12:	10.6	↘
13:	10.5	↓
14:	10.6x	↗
15:	10.5	↗
16:	10.5	↗
17:	10.5	←
18:	10.3	↑
19:	10.0	↓
20:	10.7x	↑

Serie	100 (2x)
Total	198 (5x)

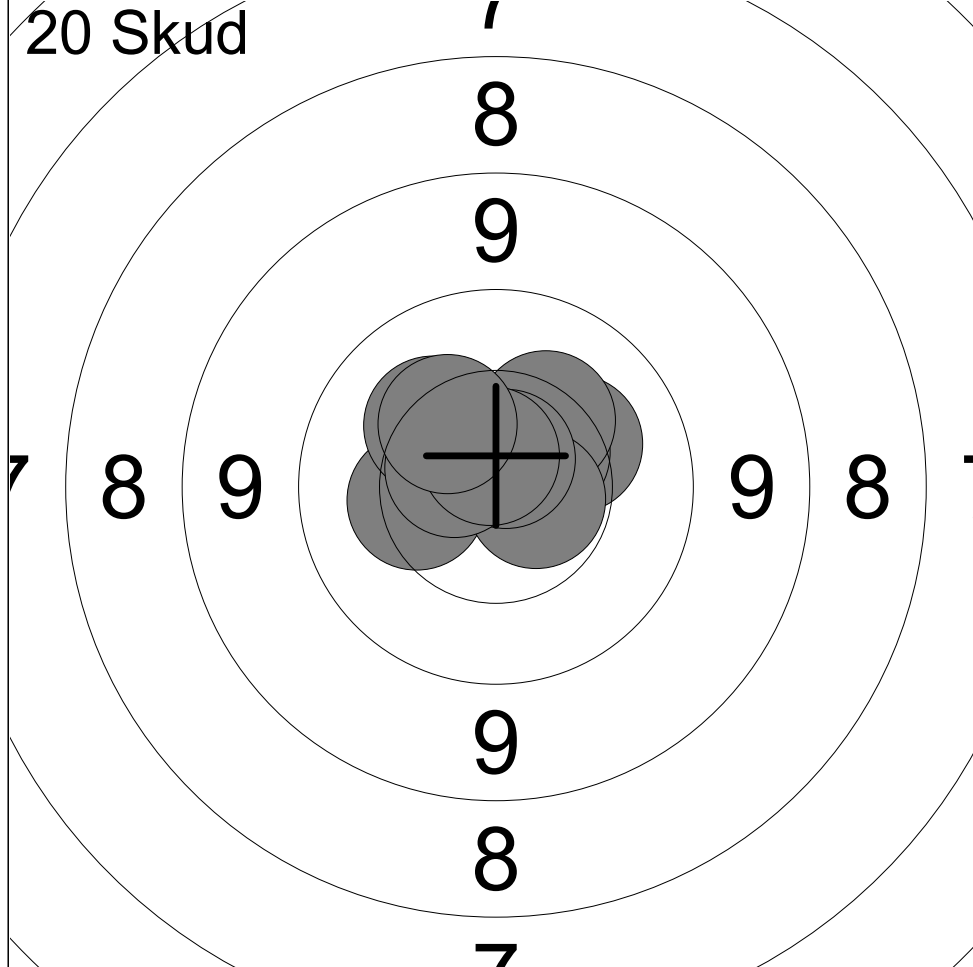

1:	10.3	←
2:	10.3	↗
3:	10.5	↗
4:	10.3	↖
5:	10.3	↗
6:	10.6x	→
7:	10.7x	↗
8:	10.6x	↖
9:	10.7x	↗
10:	10.3	↖

Serie	100 (4x)
Total	100 (4x)

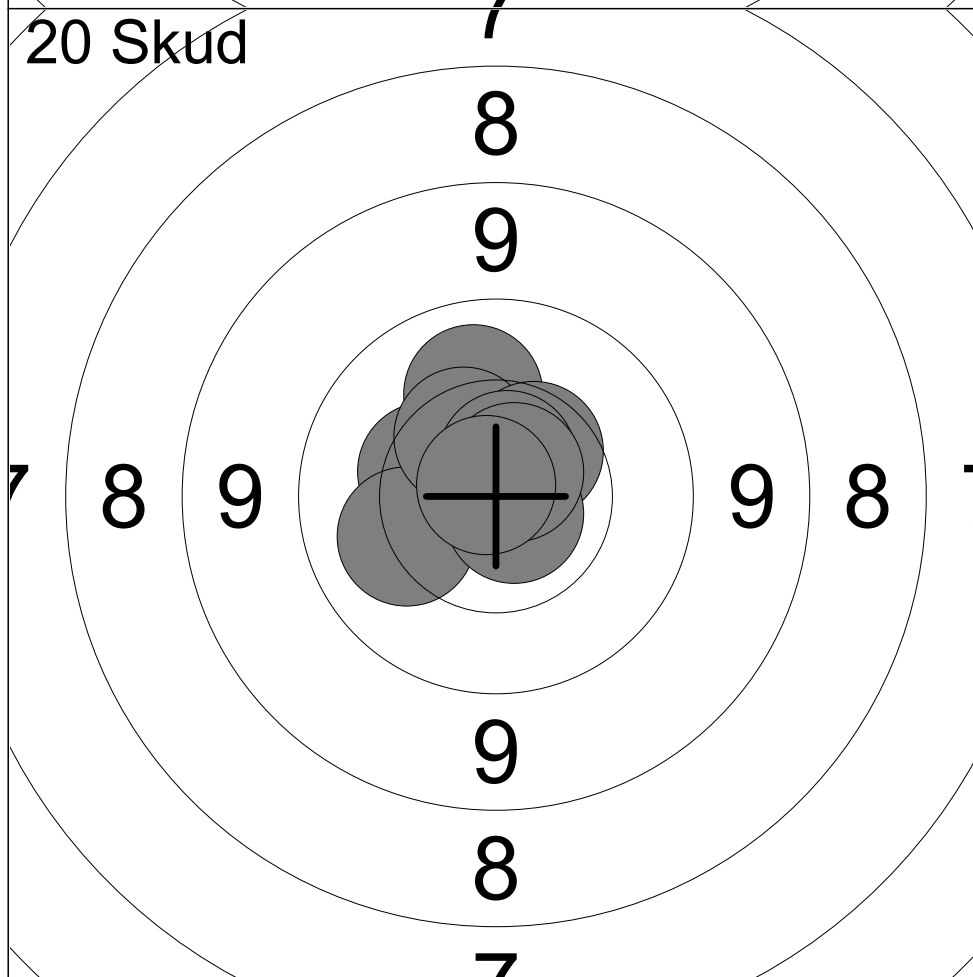

11:	10.4	↖
12:	10.2	↖
13:	10.1	↗
14:	10.4	↖
15:	10.8x	→
16:	10.5	↗
17:	10.8x	↘
18:	10.7x	↗
19:	10.7x	↗
20:	10.8x	↖

Serie	100 (5x)
Total	200 (9x)

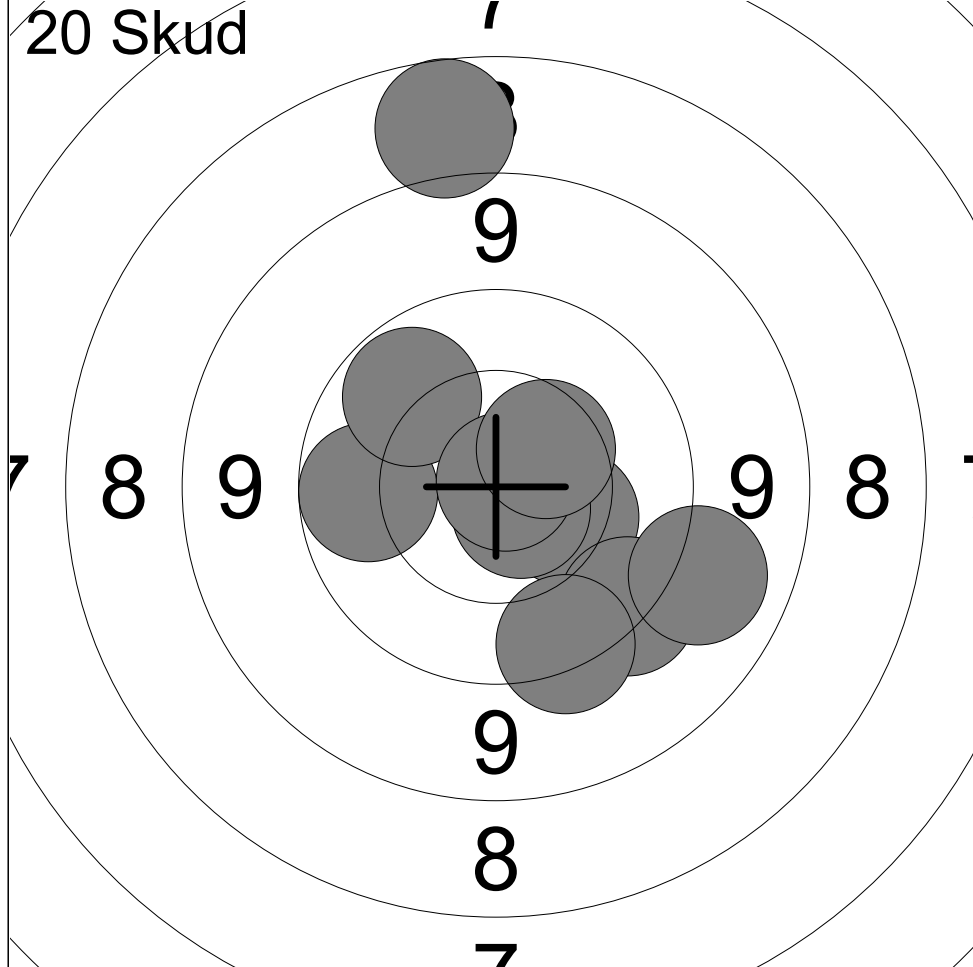

1:	9.9	←
2:	10.0	↗
3:	10.3	↘
4:	7.9	↑
5:	10.7x	↘
6:	10.9x	↗
7:	10.5	↗
8:	9.5	↘
9:	9.2	↘
10:	9.6	↘

Serie	93 (2x)
Total	93 (2x)



11:	10.7x	↘
12:	9.1	↗
13:	9.8	←
14:	9.1	↗
15:	9.9	←
16:	10.4	↘
17:	9.9	↑
18:	10.4	↘
19:	9.7	↗
20:	9.2	↘

Serie	93 (1x)
Total	186 (3x)

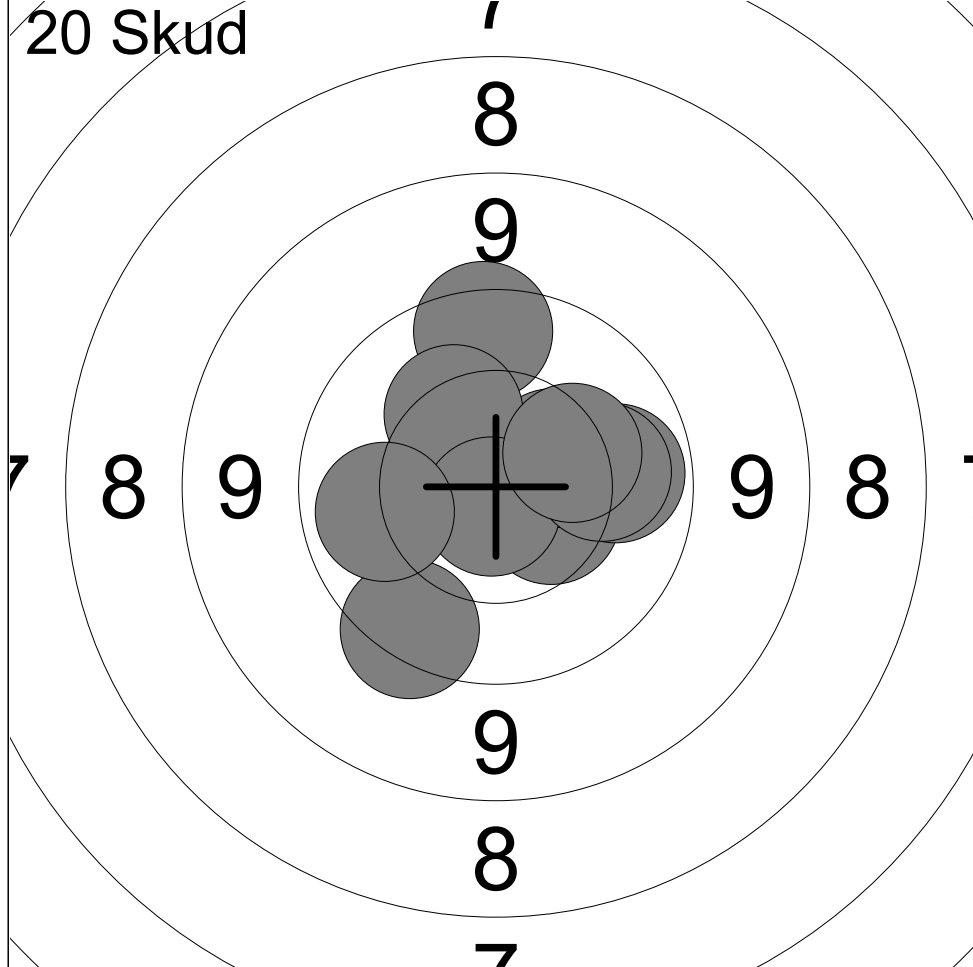

1:	10.5	↘
2:	10.4	↗
3:	9.7	↑
4:	10.3	↖
5:	9.6	↙
6:	10.8x	↙
7:	10.0	→
8:	10.1	←
9:	10.1	→
10:	10.3	↗

Serie	98 (1x)
Total	98 (1x)

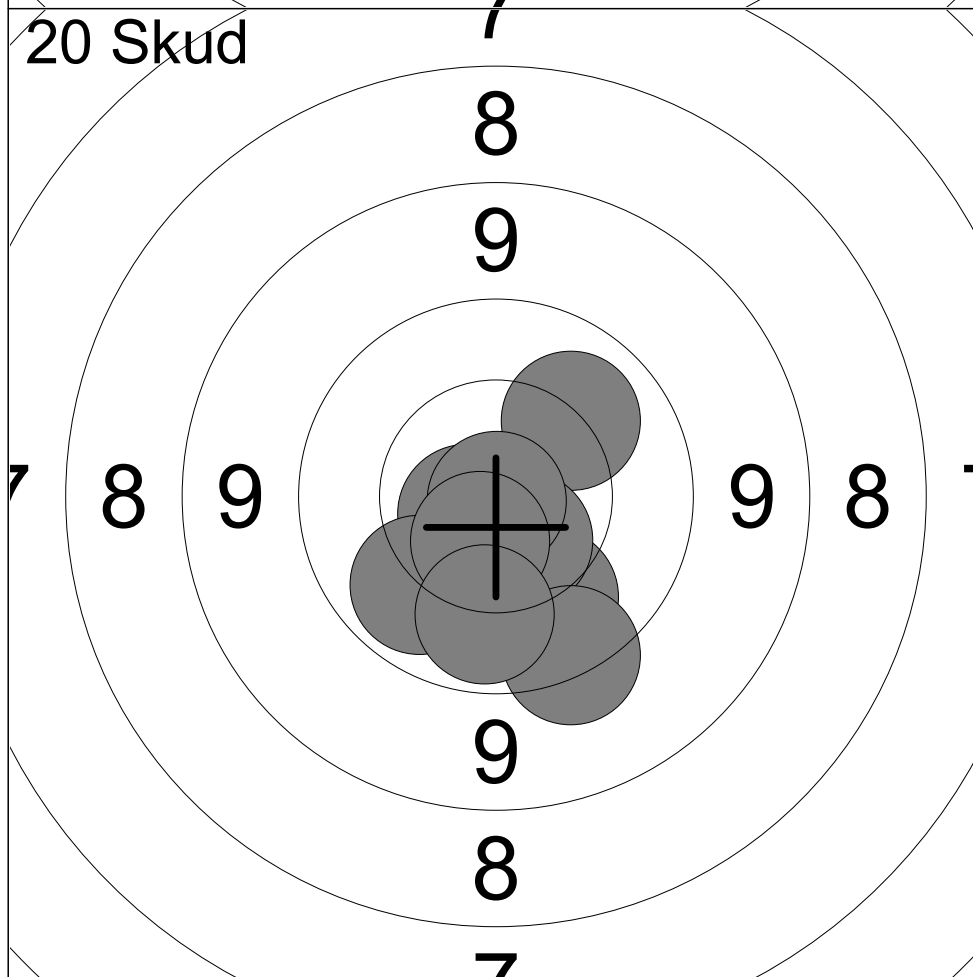

11:	10.1	↘
12:	10.5	↘
13:	10.7x	↖
14:	10.1	↗
15:	10.5	↘
16:	10.0	↙
17:	10.9x	↘
18:	10.6	↙
19:	9.5	↘
20:	10.0	↘

Serie	99 (2x)
Total	197 (3x)

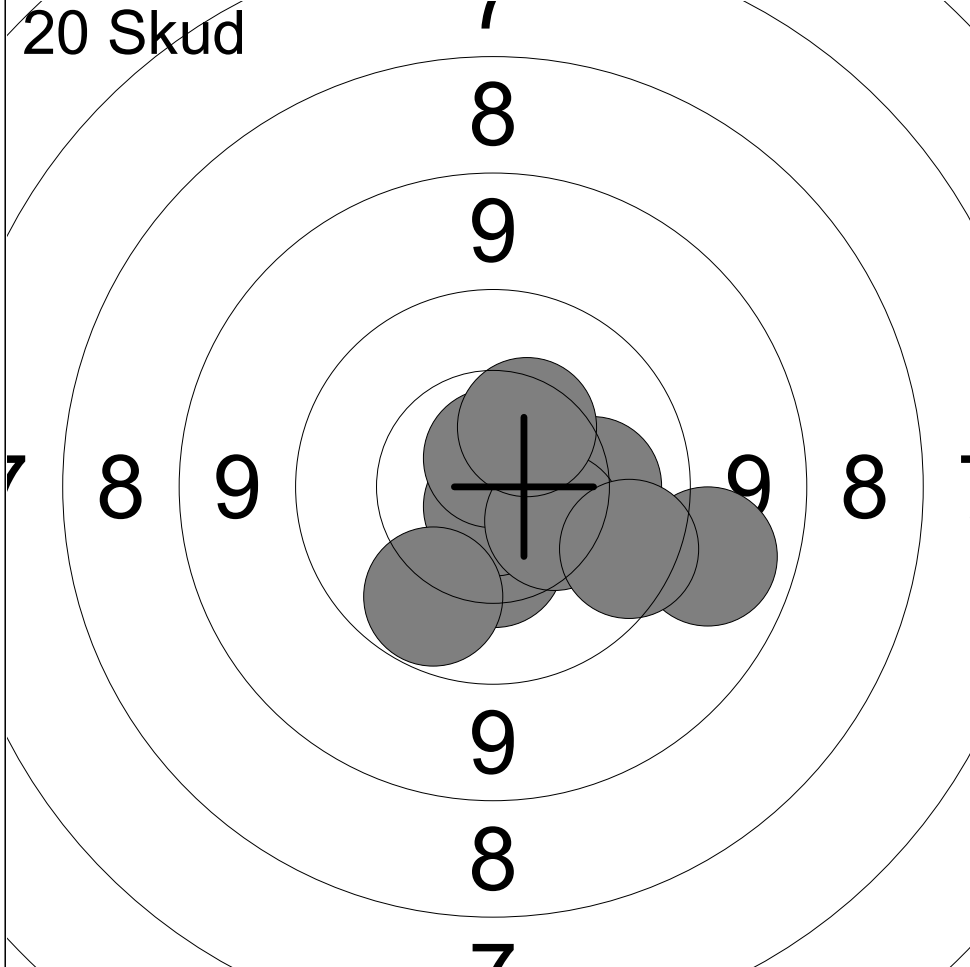

1:	10.4	↓
2:	10.7x	→
3:	10.8x	↓
4:	10.0	↙
5:	9.1	→
6:	10.2	→
7:	10.7x	↑
8:	10.4	↘
9:	9.8	↘
10:	10.4	↗

Serie	98 (3x)
Total	98 (3x)

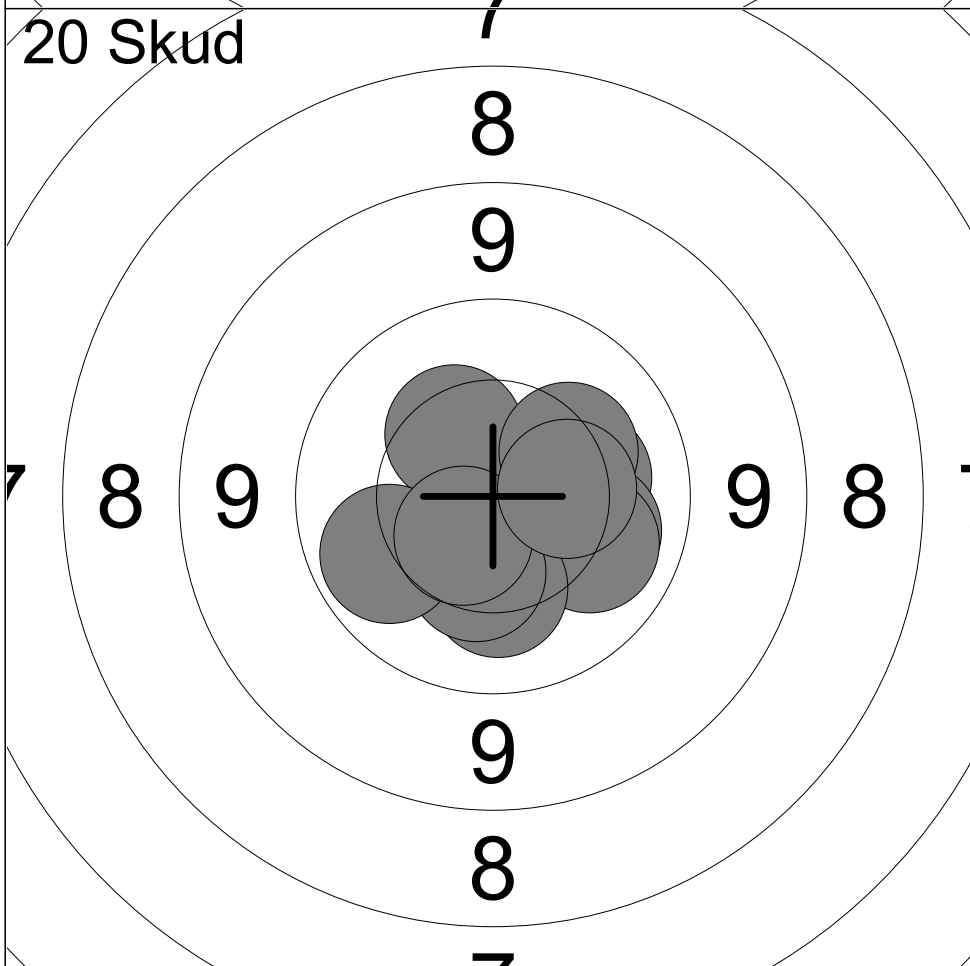

11:	10.2	→
12:	10.1	→
13:	10.1	↘
14:	10.2	↓
15:	10.3	↓
16:	10.4	↖
17:	10.0	↙
18:	10.3	↗
19:	10.6	↙
20:	10.4	→

Serie	100 (0x)
Total	198 (3x)

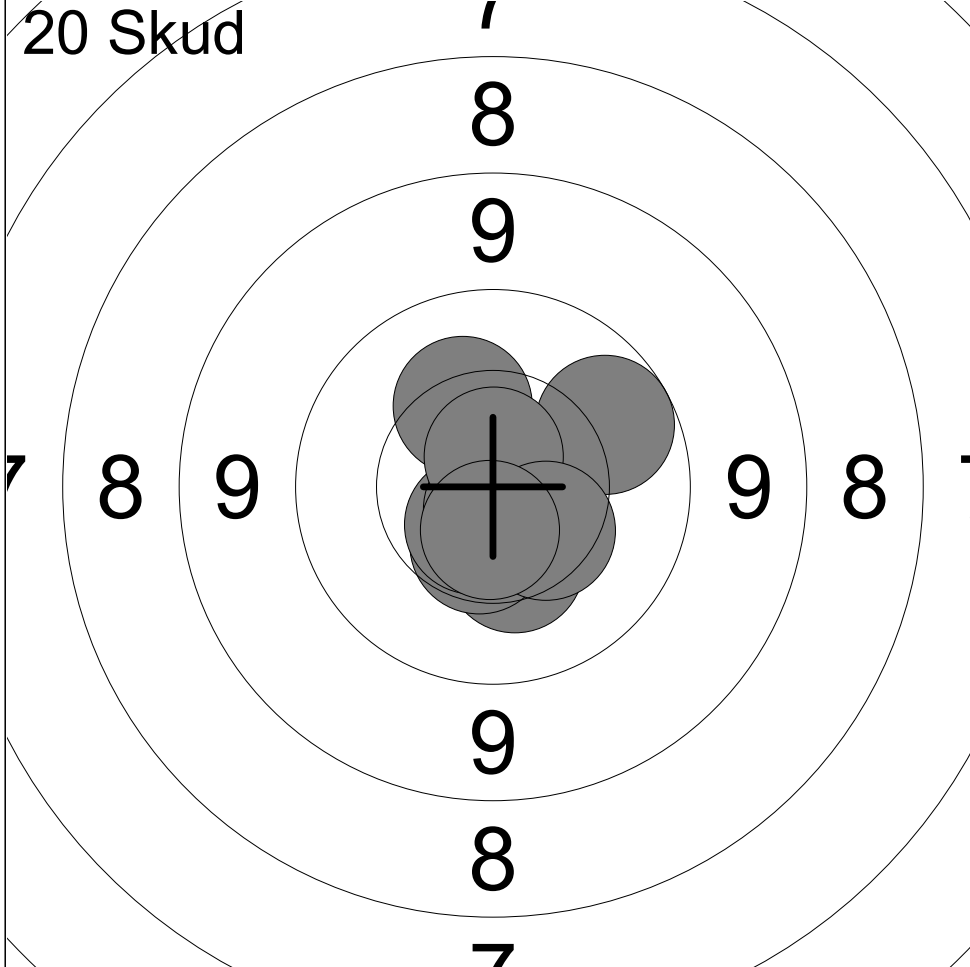

1:	10.3	↘
2:	9.9	↗
3:	10.7x	↘
4:	10.3	↗
5:	10.5	↘
6:	10.6x	↘
7:	10.8x	↘
8:	10.7x	↗
9:	10.4	↘
10:	10.6x	↘

Serie	99 (5x)
-------	----------

Total	99 (5x)
-------	----------

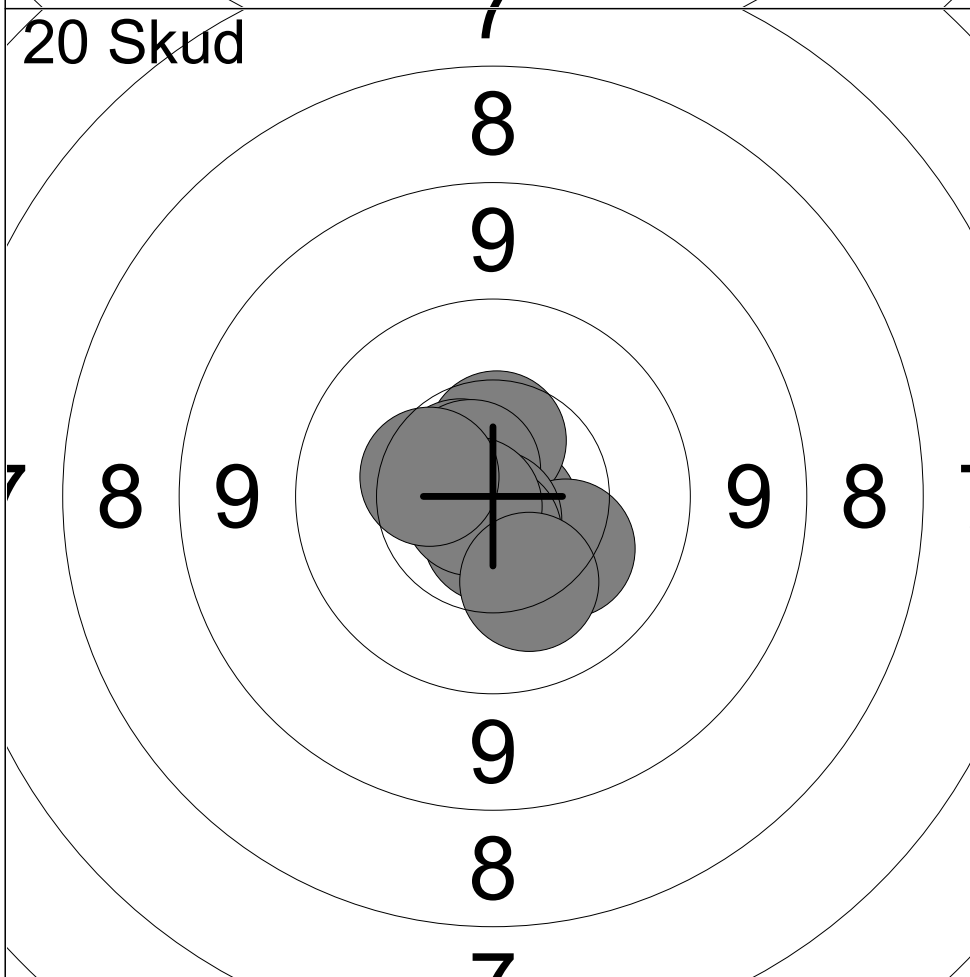

11:	10.8x	↘
12:	10.5	↗
13:	10.6x	↗
14:	10.7x	↗
15:	10.3	↘
16:	10.8x	↘
17:	10.7x	↘
18:	10.8x	↖
19:	10.4	↖
20:	10.2	↘

Serie	100 (6x)
-------	-----------

Total	199 (11x)
-------	-----------

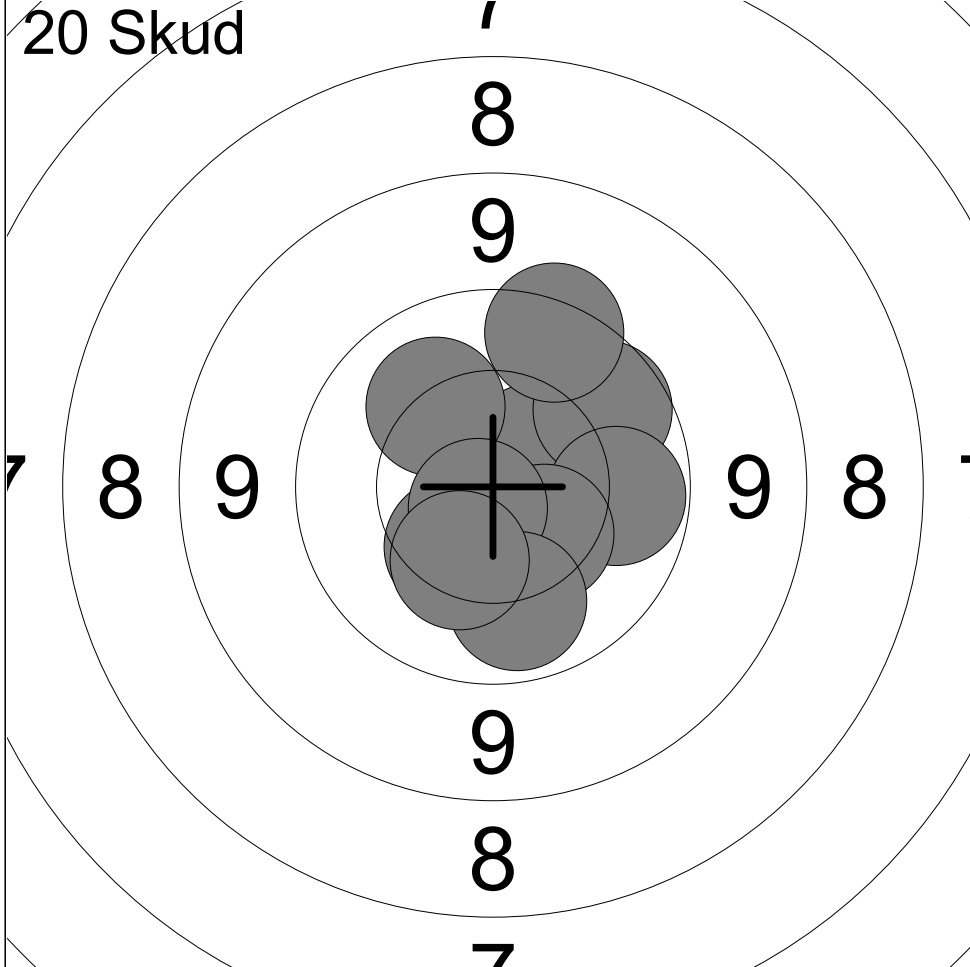

1:	10.5	↗
2:	9.9	↗
3:	10.0	→
4:	10.4	↙
5:	10.4	↘
6:	10.2	↗
7:	9.6	↗
8:	10.7x	↙
9:	10.0	↓
10:	10.3	↙

Serie	98 (1x)
Total	98 (1x)

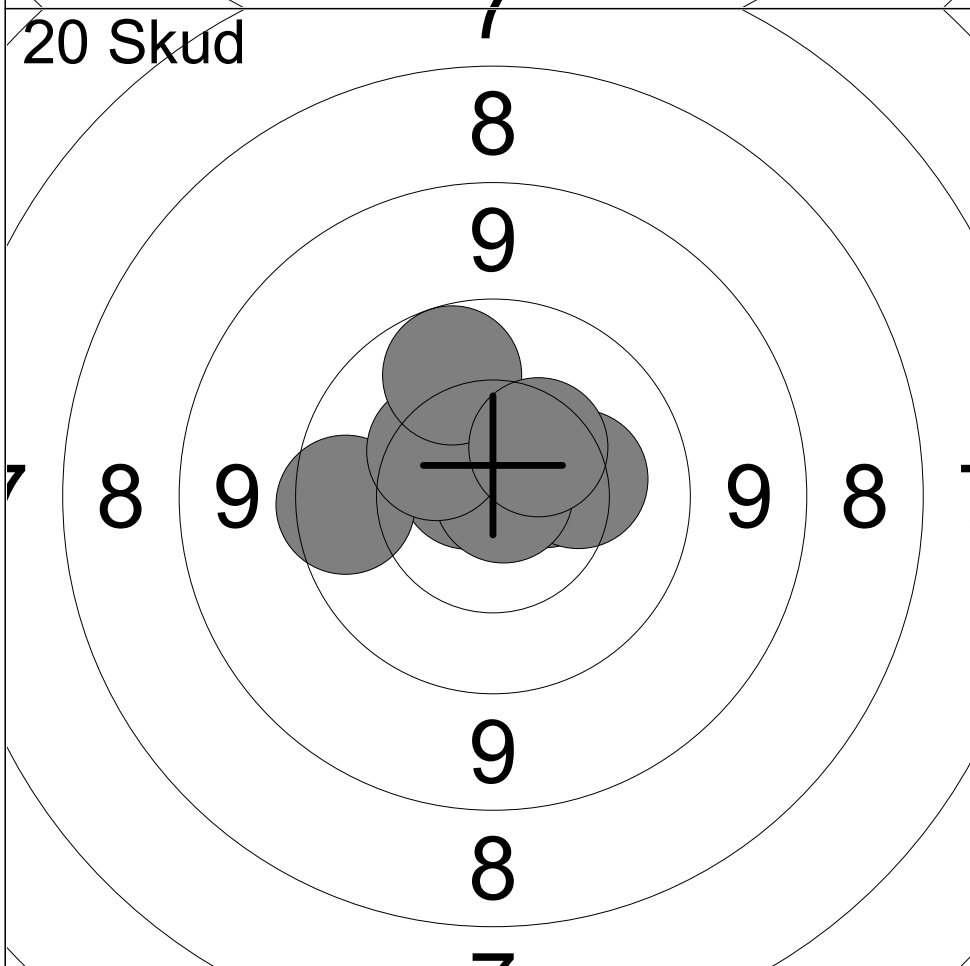

11:	10.5	→
12:	10.3	→
13:	10.8x	↑
14:	10.7x	↙
15:	10.7x	↑
16:	10.9x	→
17:	9.8	←
18:	10.4	↗
19:	9.9	↗
20:	10.4	↗

Serie	98 (4x)
Total	196 (5x)

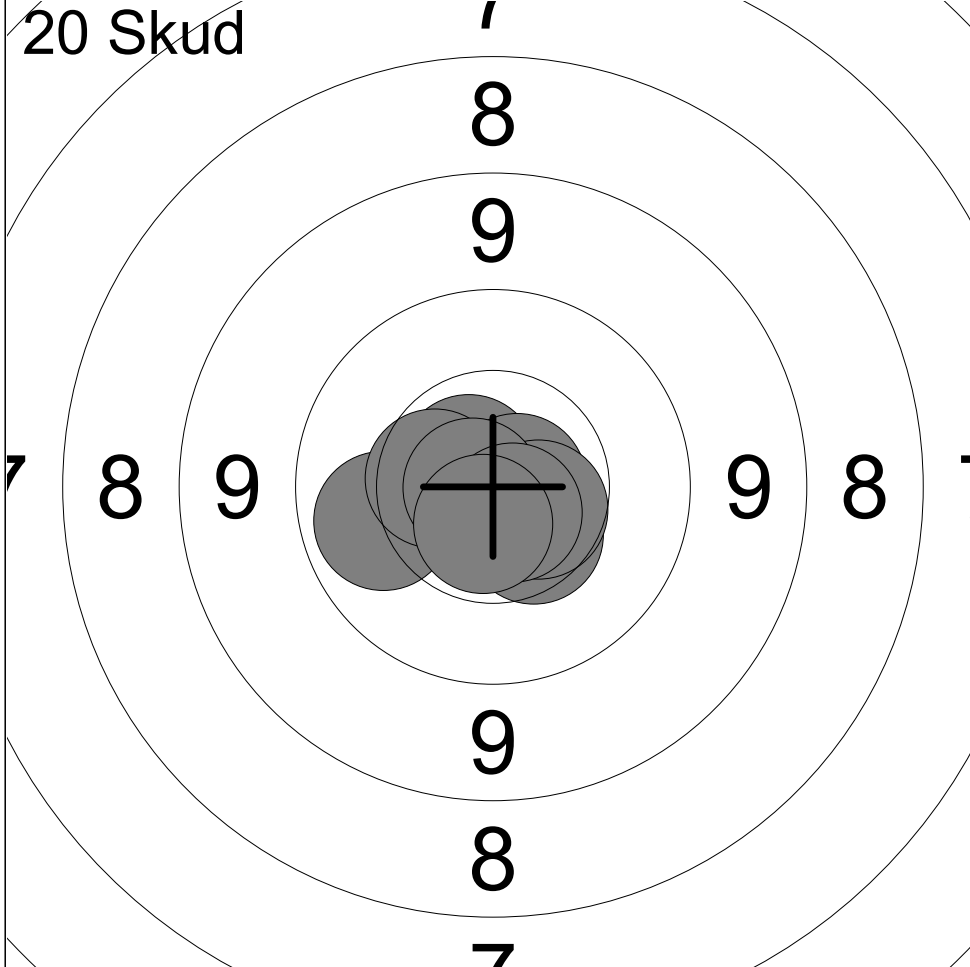

1:	10.7x	↗
2:	10.1	↖
3:	10.5	↘
4:	10.7x	→
5:	10.8x	→
6:	10.5	↖
7:	10.6	↘
8:	10.8x	↖
9:	10.7x	↘
10:	10.7x	↘

Serie	100 (6x)
Total	100 (6x)

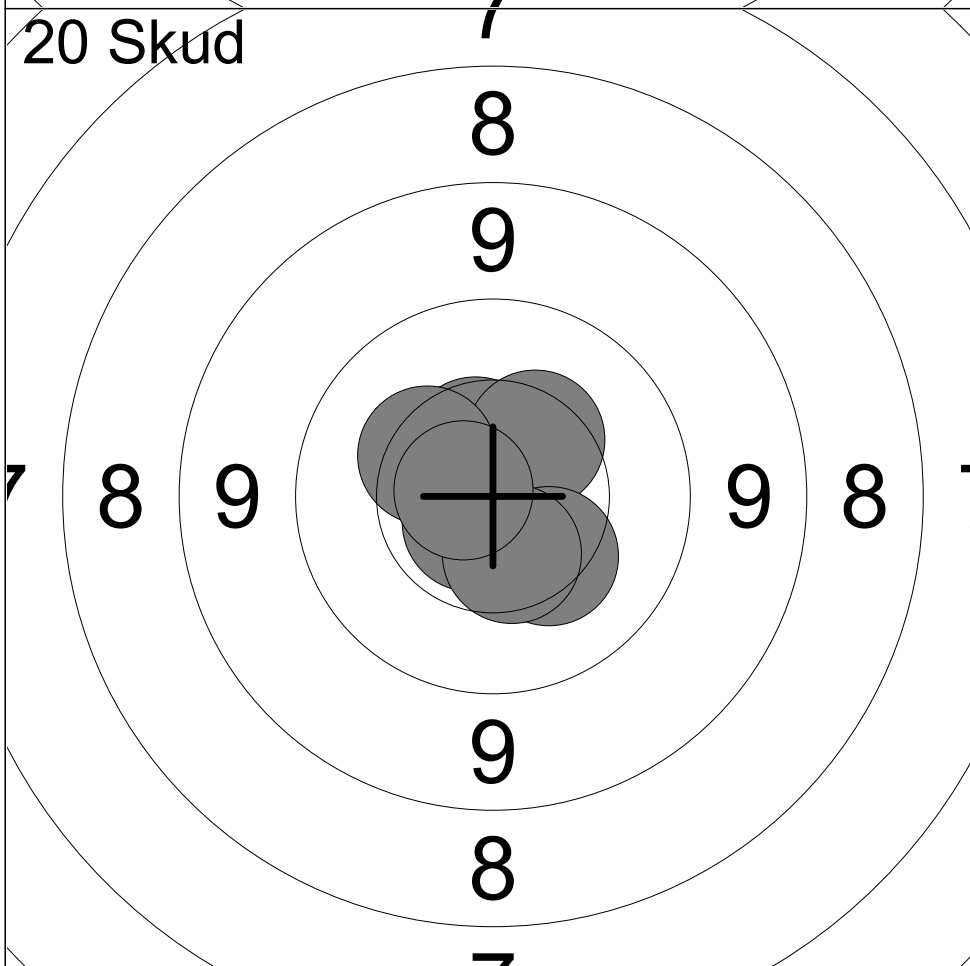

11:	10.7x	↗
12:	10.7x	↖
13:	10.5	↗
14:	10.5	↗
15:	10.7x	↗
16:	10.4	↗
17:	10.3	↘
18:	10.3	↗
19:	10.5	↘
20:	10.7x	↖

Serie	100 (4x)
Total	200 (10x)

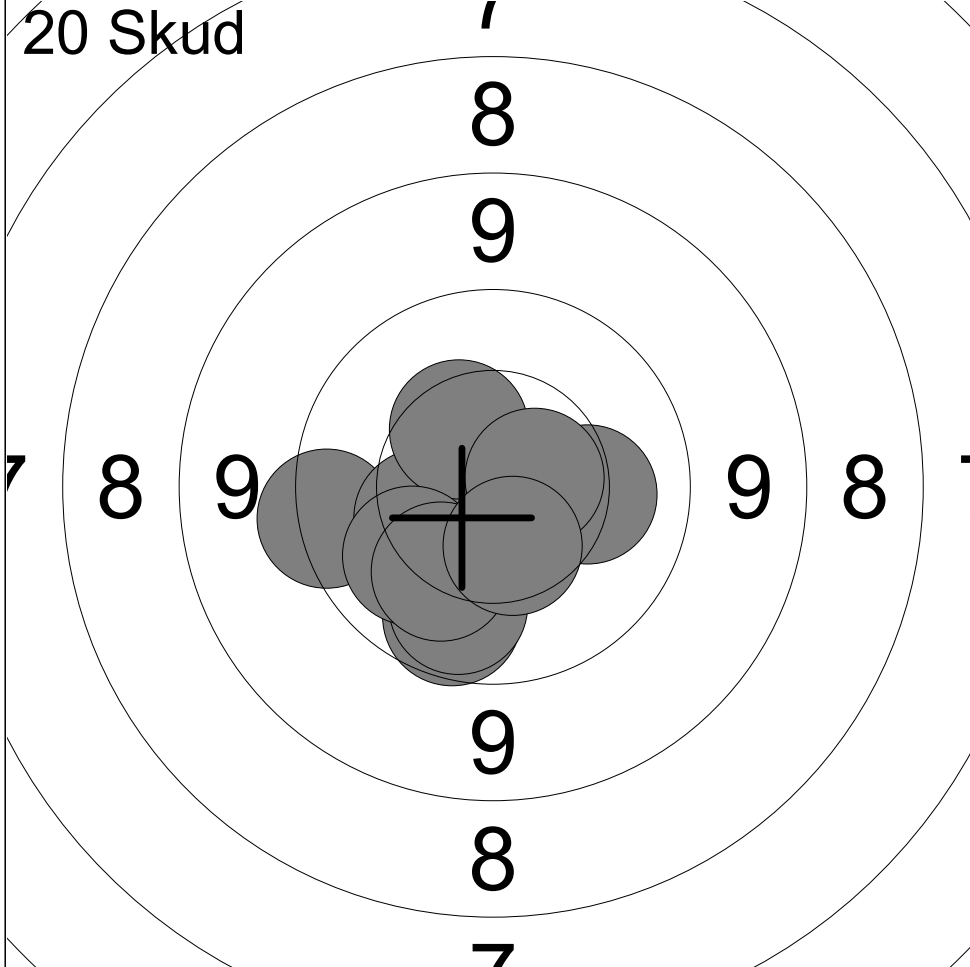

1:	10.2	→
2:	9.6	←
3:	9.9	↘
4:	10.4	←
5:	10.4	↗
6:	10.6x	→
7:	10.0	↘
8:	10.1	↖
9:	10.2	↘
10:	10.5	↘

Serie	98 (1x)
Total	98 (1x)

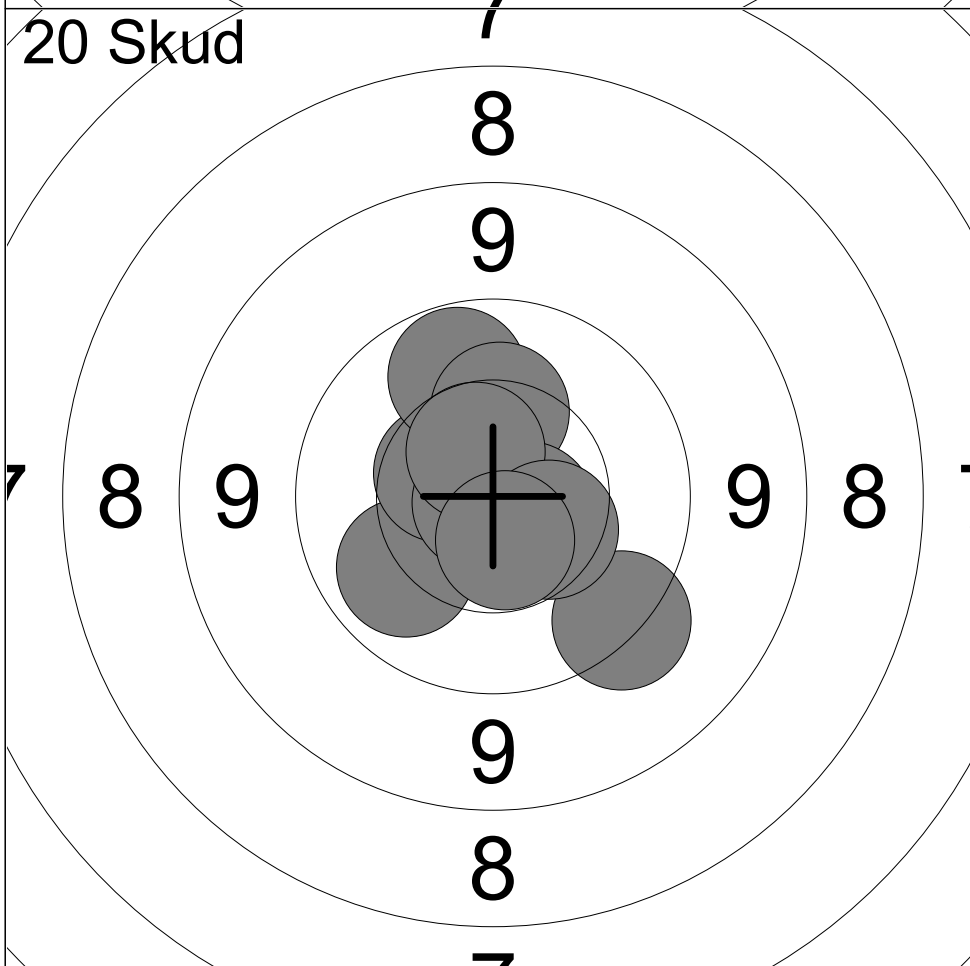

11:	10.1	↖
12:	10.5	↖
13:	10.8x	↖
14:	10.0	↗
15:	9.5	↘
16:	10.3	↗
17:	10.7x	↘
18:	10.6	↗
19:	10.4	↘
20:	10.6x	↘

Serie	99 (3x)
Total	197 (4x)

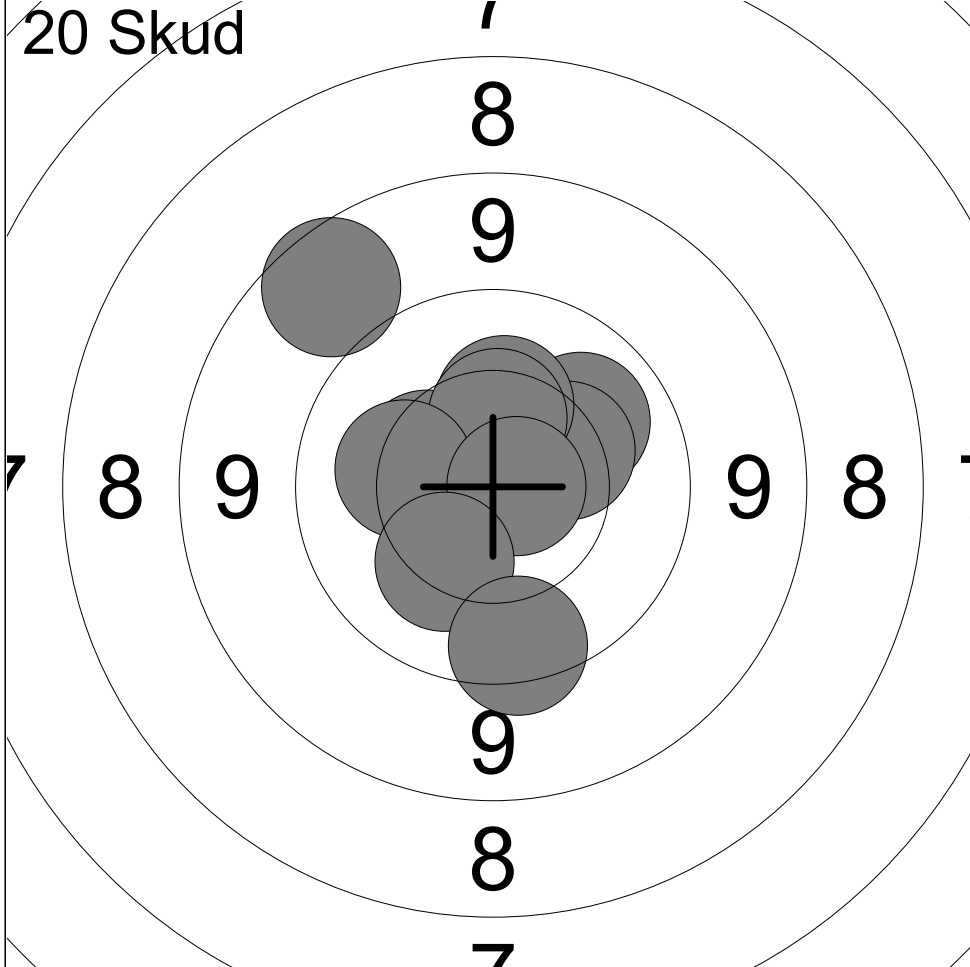

1:	10.1	↗
2:	10.3	↗
3:	10.4	↖
4:	10.3	↑
5:	8.8	↖
6:	10.4	↑
7:	10.2	↖
8:	10.8x	→
9:	10.3	↙
10:	9.7	↓

Serie	97 (1x)
Total	97 (1x)

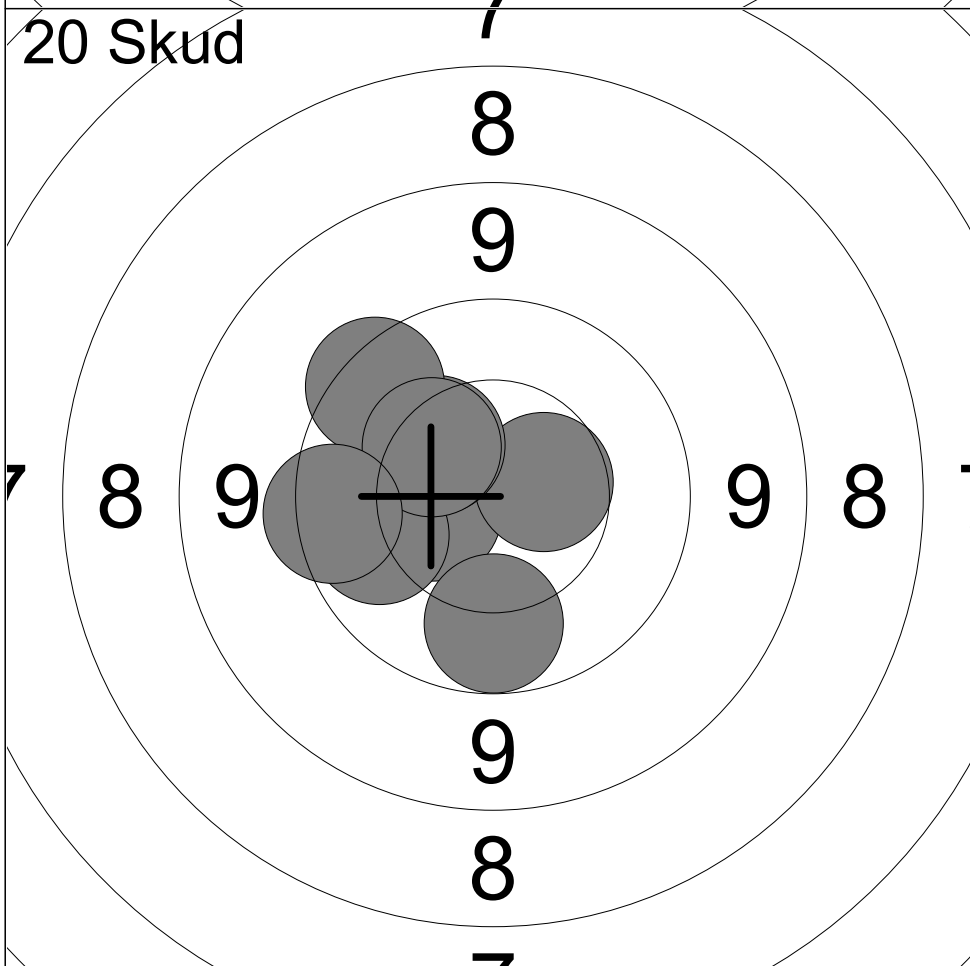

11:	10.5	↖
12:	10.5	↖
13:	10.5	→
14:	10.2	↖
15:	10.3	↖
16:	9.7	↖
17:	10.0	↖
18:	10.3	↖
19:	10.0	↓
20:	9.7	↖

Serie	98 (0x)
Total	195 (1x)

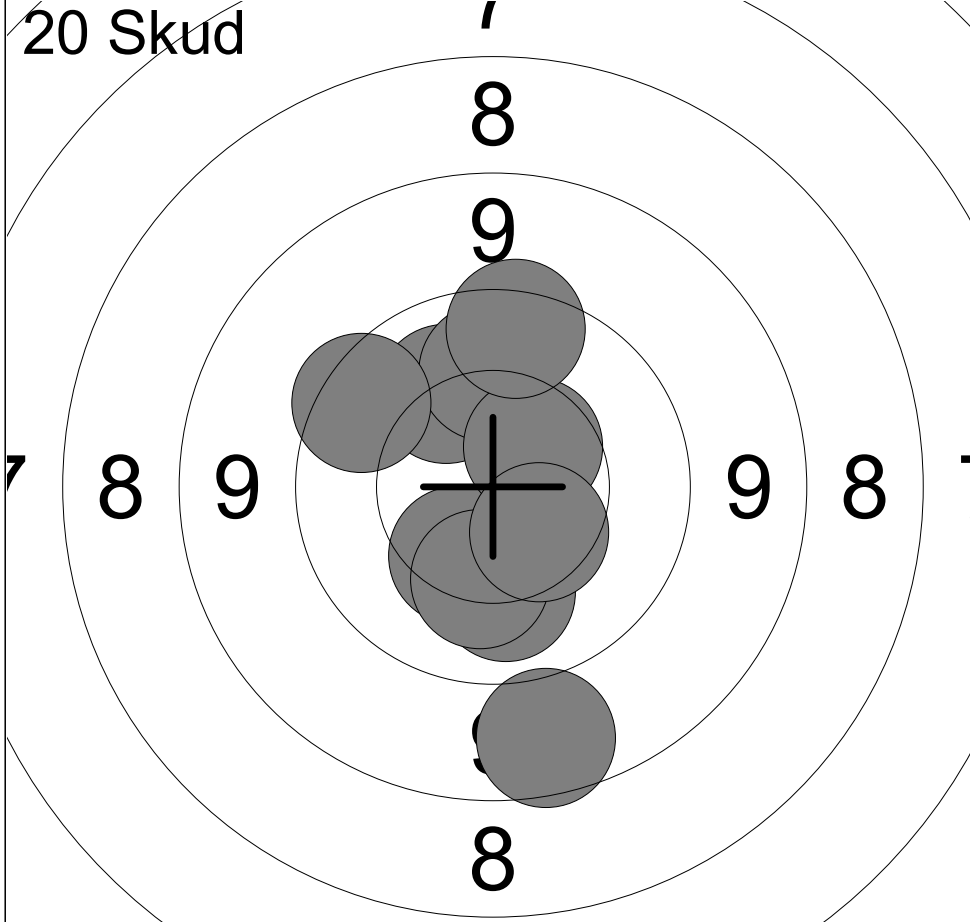

1:	10.1	↓
2:	10.1	↖
3:	10.3	↙
4:	10.2	↓
5:	10.1	↑
6:	8.8	↓
7:	10.5	↗
8:	9.7	↖
9:	10.4	↘
10:	9.7	↑

Serie	96 (0x)
-------	----------

Total	96 (0x)
-------	----------

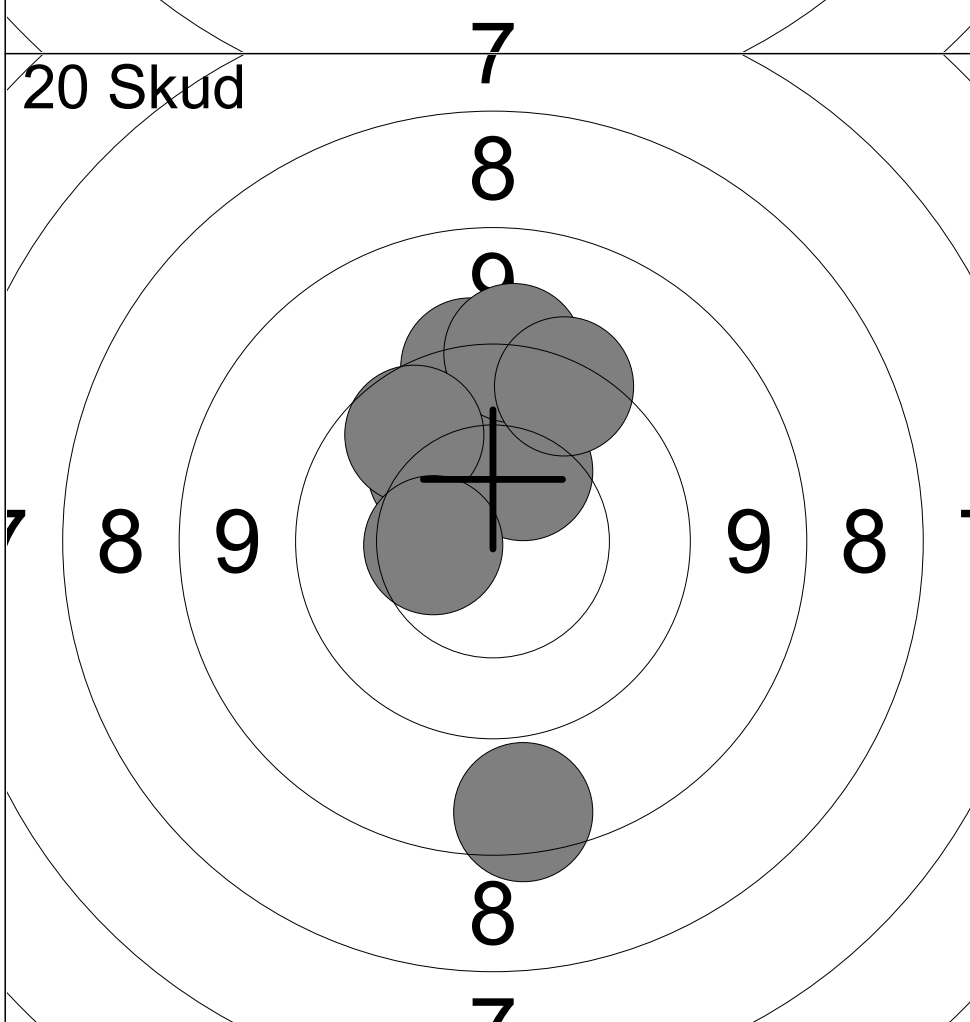

11:	8.7	↓
12:	10.2	↖
13:	9.5	↑
14:	10.3	↑
15:	9.9	↑
16:	10.4	↗
17:	9.4	↑
18:	9.6	↗
19:	9.9	↖
20:	10.5	←

Serie	93 (0x)
-------	----------

Total	189 (0x)
-------	-----------

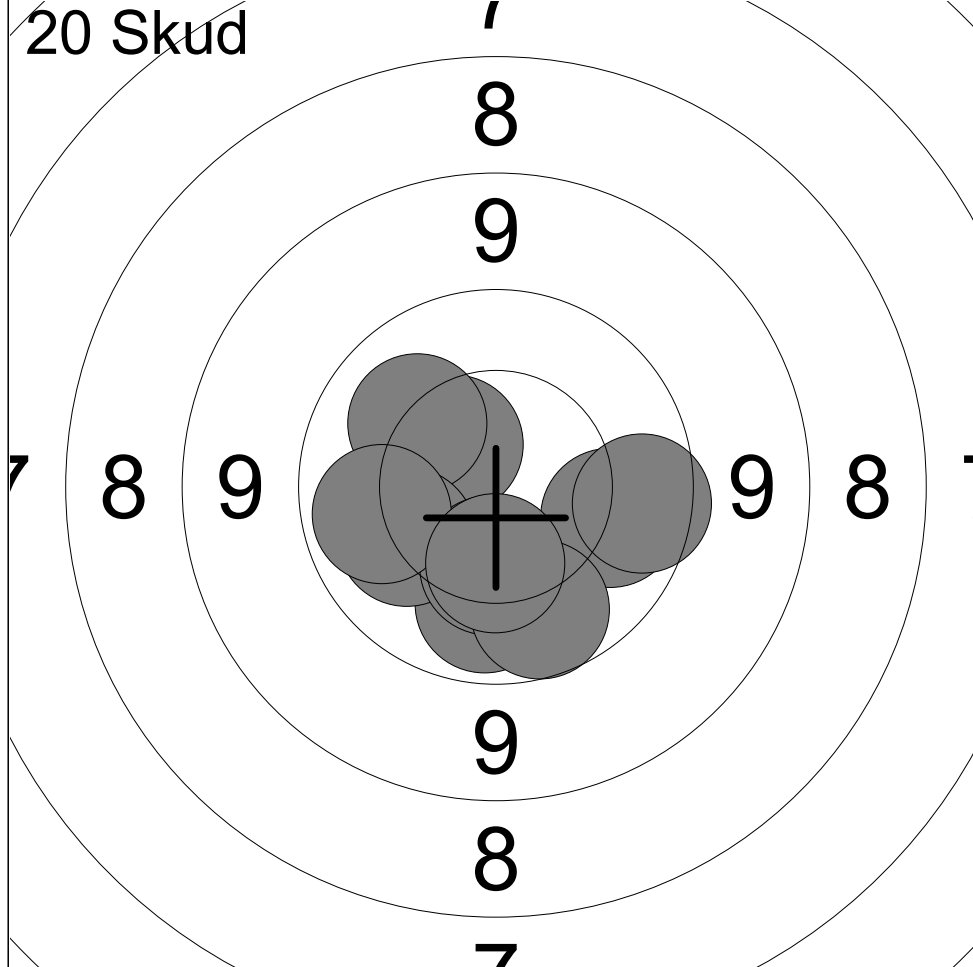

1:	10.5	↗
2:	10.2	↗
3:	10.0	→
4:	10.0	↓
5:	10.2	↖
6:	10.3	↓
7:	10.0	↖
8:	9.9	↓
9:	9.8	→
10:	10.4	↓

Serie	98 (0x)
Total	98 (0x)

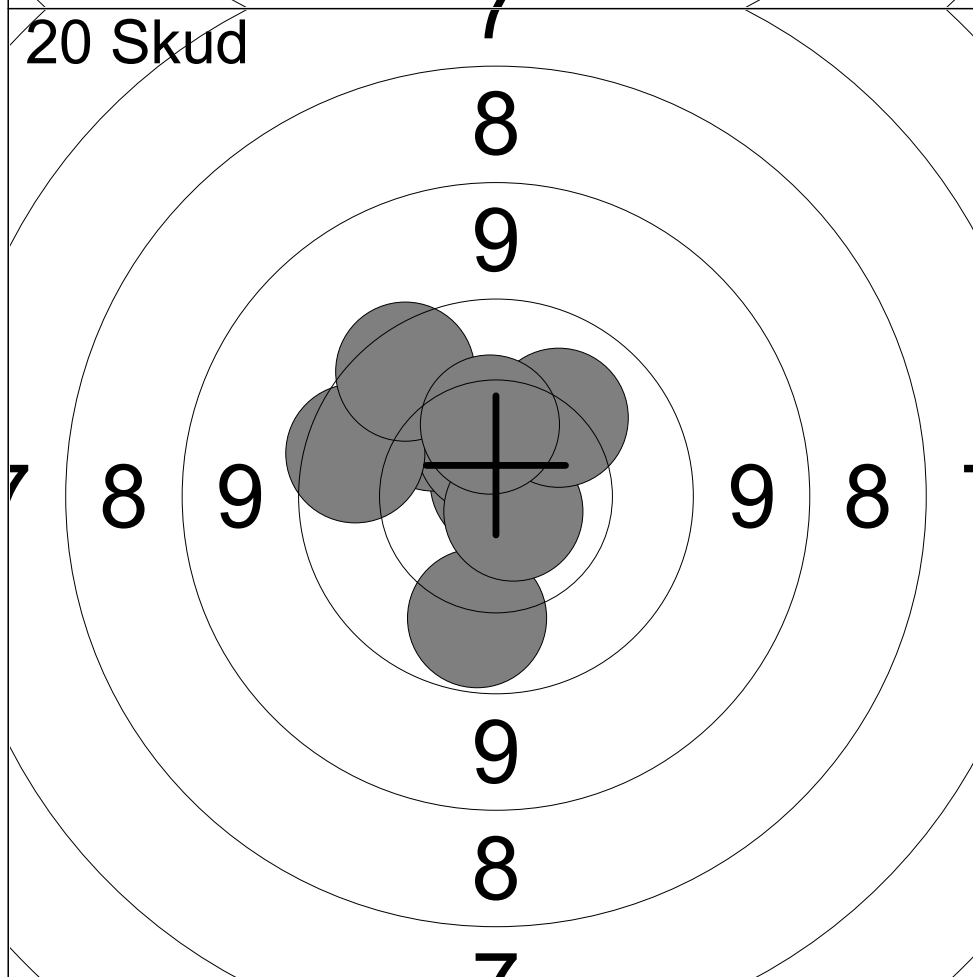

11:	10.0	↓
12:	10.8x	↗
13:	10.2	↗
14:	10.5	↗
15:	9.8	↖
16:	10.5	↗
17:	10.8x	↘
18:	9.7	↗
19:	10.2	↗
20:	10.4	↗

Serie	98 (2x)
Total	196 (2x)

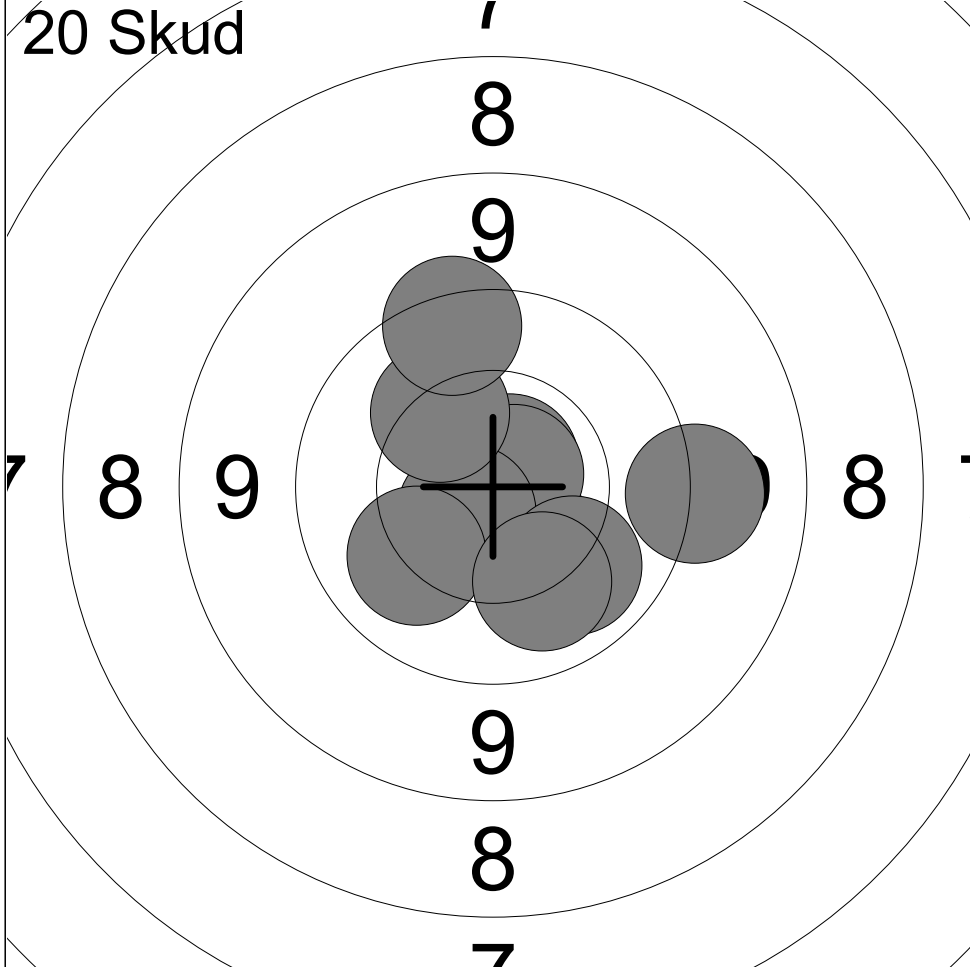

1:	10.6x	↘
2:	9.3	→
3:	10.7x	↗
4:	10.8x	↗
5:	10.7x	↖
6:	10.2	↗
7:	10.1	↘
8:	10.1	↖
9:	10.1	↘
10:	9.6	↗

Serie	98 (4x)
Total	98 (4x)

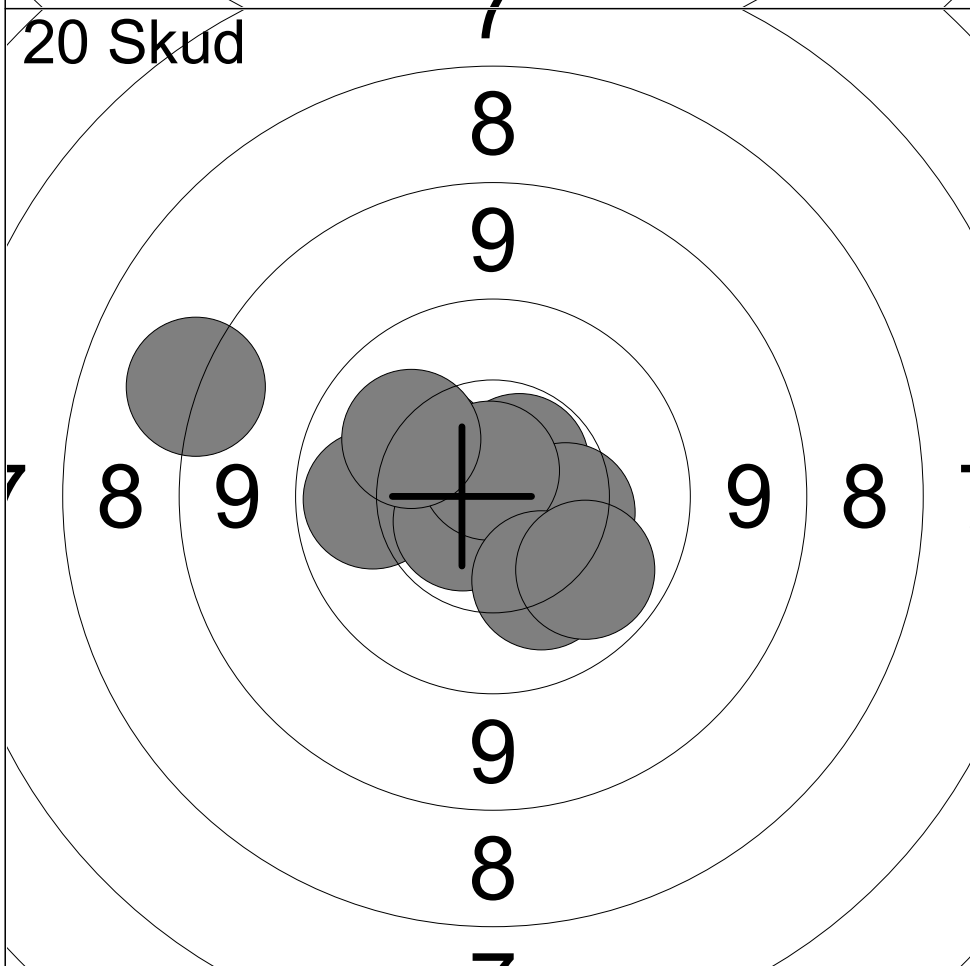

11:	10.3	↖
12:	10.0	←
13:	10.6x	↗
14:	10.6x	↖
15:	10.4	→
16:	10.7x	↗
17:	10.2	↗
18:	10.2	↘
19:	8.3	↖
20:	10.0	↘

Serie	98 (3x)
Total	196 (7x)

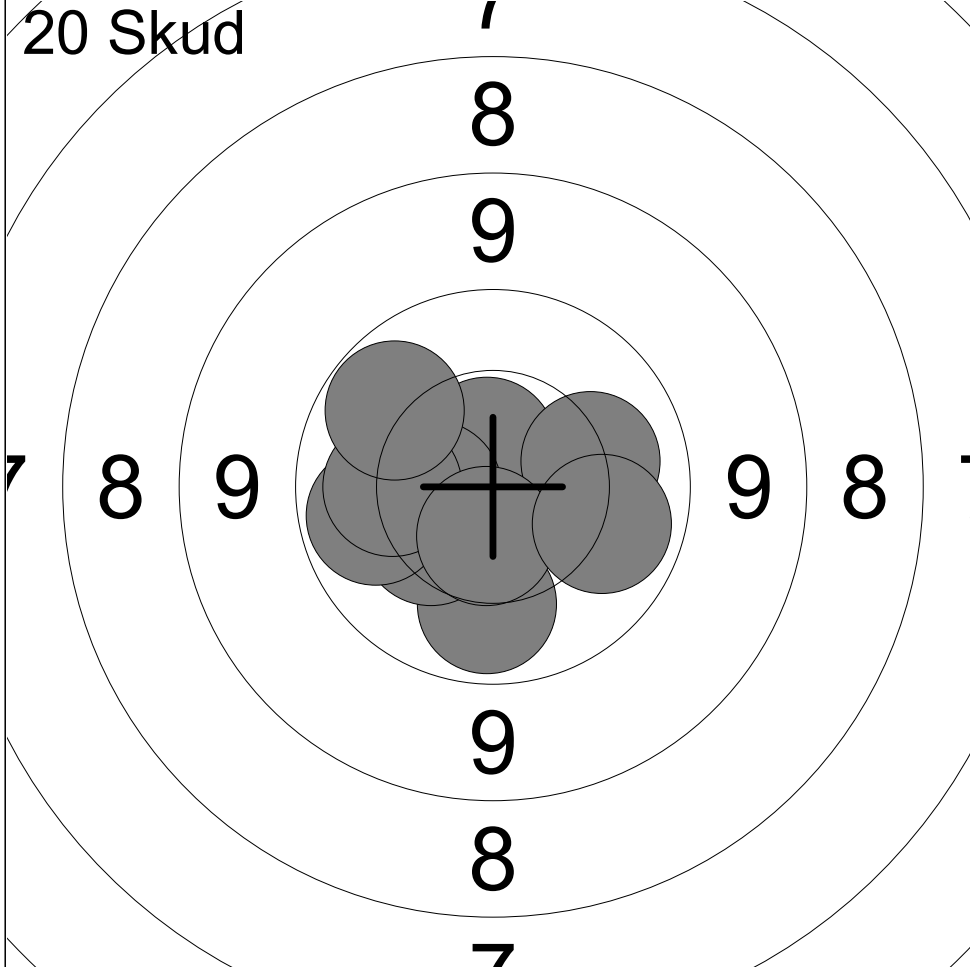

1:	10.0	↓
2:	10.3	↙
3:	10.6x	↑
4:	10.5	←
5:	10.2	→
6:	10.0	↙
7:	10.2	←
8:	10.0	↗
9:	10.6	↓
10:	10.0	↘

Serie	100 (1x)
Total	100 (1x)

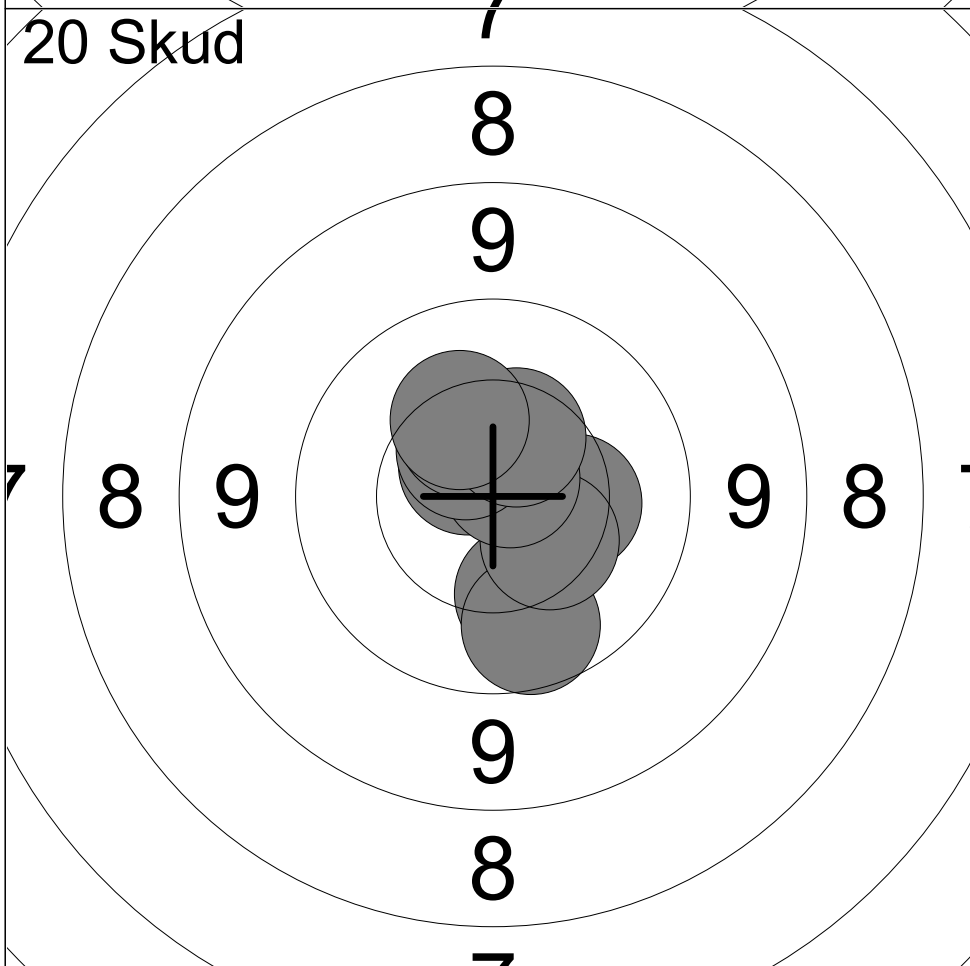

11:	10.1	↓
12:	10.3	→
13:	9.9	↓
14:	10.6x	↗
15:	10.4	↘
16:	10.8x	↗
17:	10.5	↗
18:	10.4	↗
19:	10.5	↗
20:	10.3	↖

Serie	99 (2x)
Total	199 (3x)

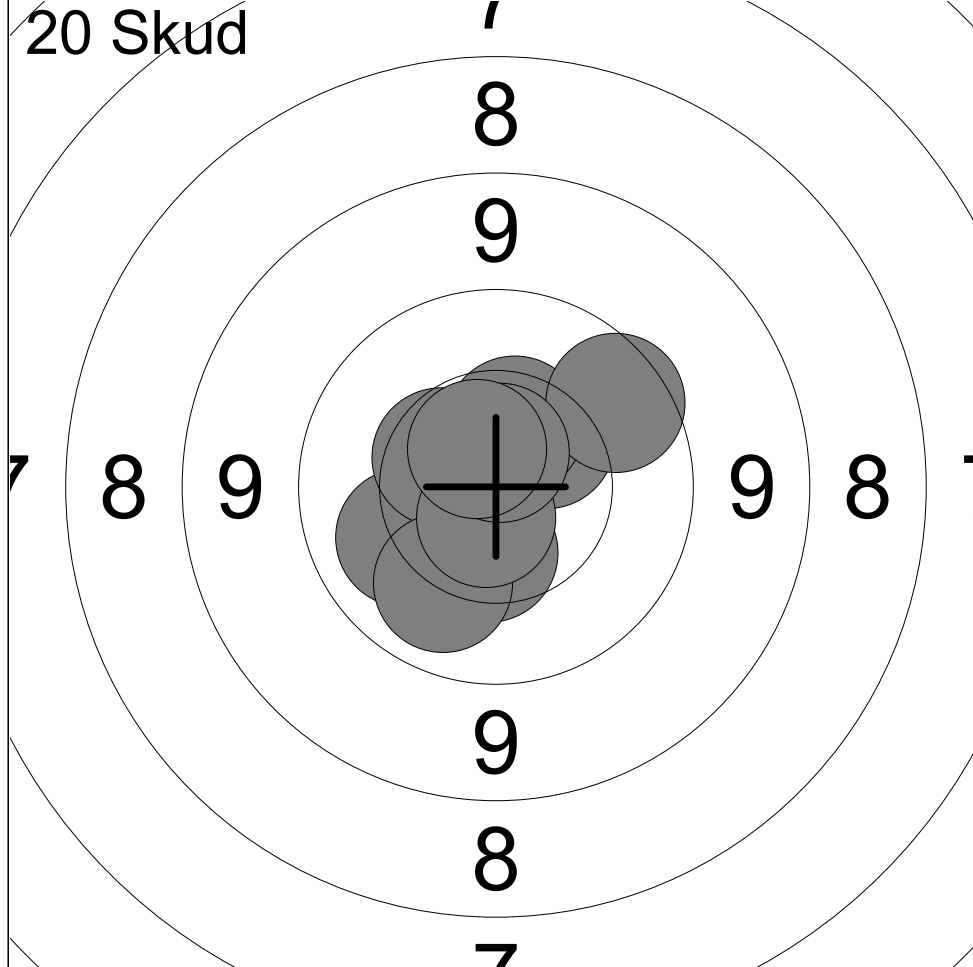

1:	10.4	↓
2:	10.4	↗
3:	10.5	↗
4:	10.1	↖
5:	10.5	↖
6:	10.1	↖
7:	9.8	↗
8:	10.7x	↓
9:	10.7x	↑
10:	10.6x	↖

Serie	99 (3x)
Total	99 (3x)

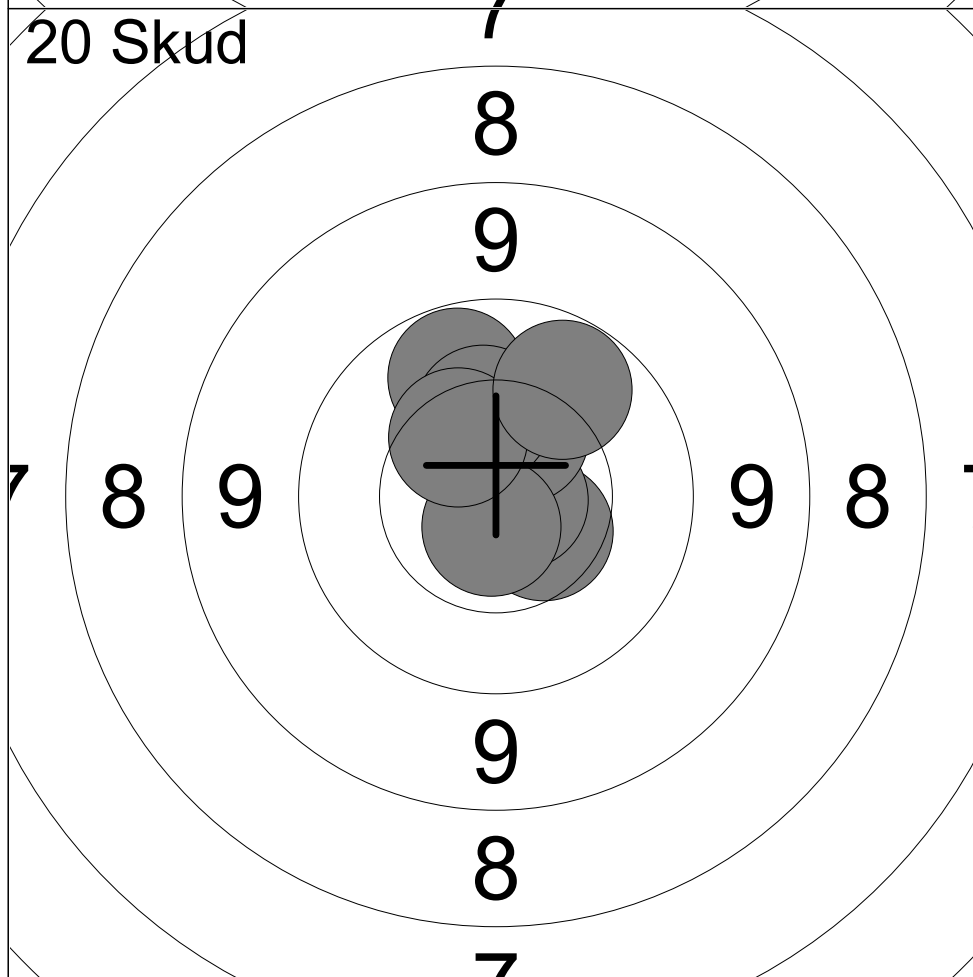

11:	10.6x	↑
12:	10.5	↘
13:	10.7x	↑
14:	10.8x	→
15:	10.4	↗
16:	10.0	↗
17:	10.3	↗
18:	10.7x	↓
19:	10.4	↖
20:	10.0	↗

Serie	100 (4x)
Total	199 (7x)

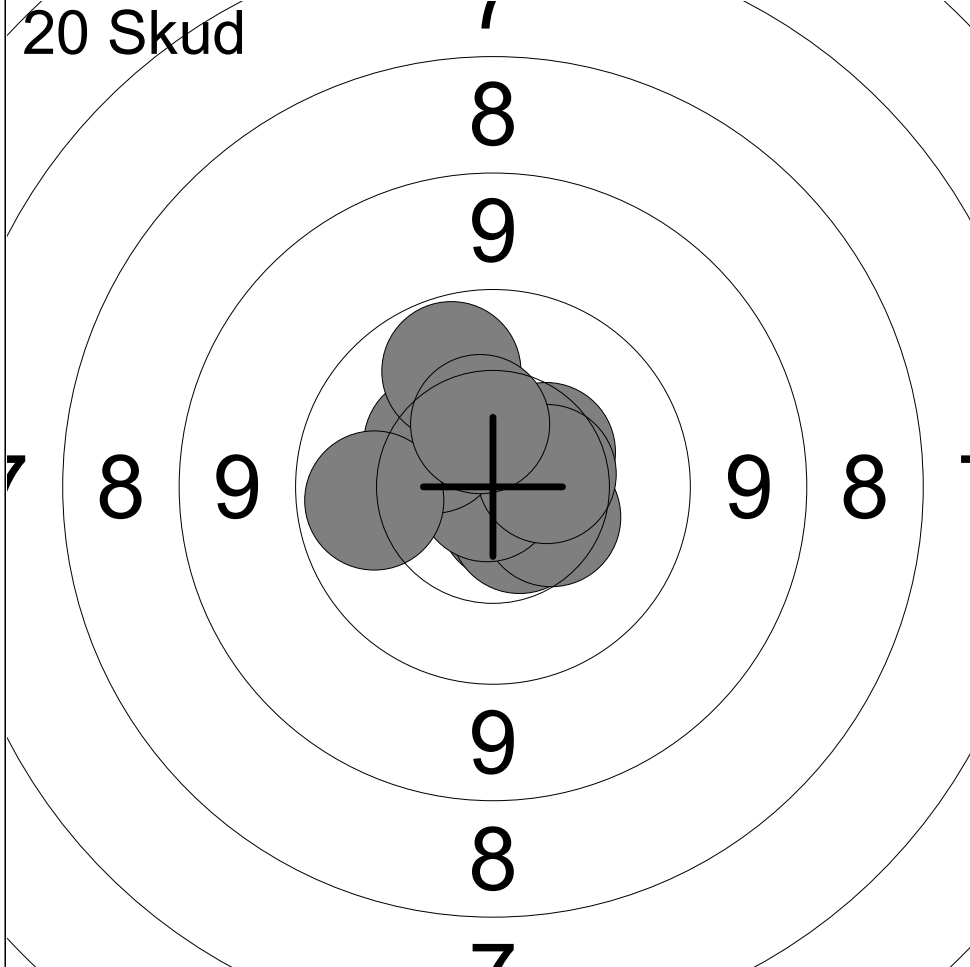

1:	10.7x	↘
2:	10.6x	↘
3:	10.4	↘
4:	10.9x	↙
5:	10.5	↗
6:	10.5	→
7:	10.4	↖
8:	10.0	↗
9:	10.0	←
10:	10.4	↗

Serie	100 (3x)
Total	100 (3x)

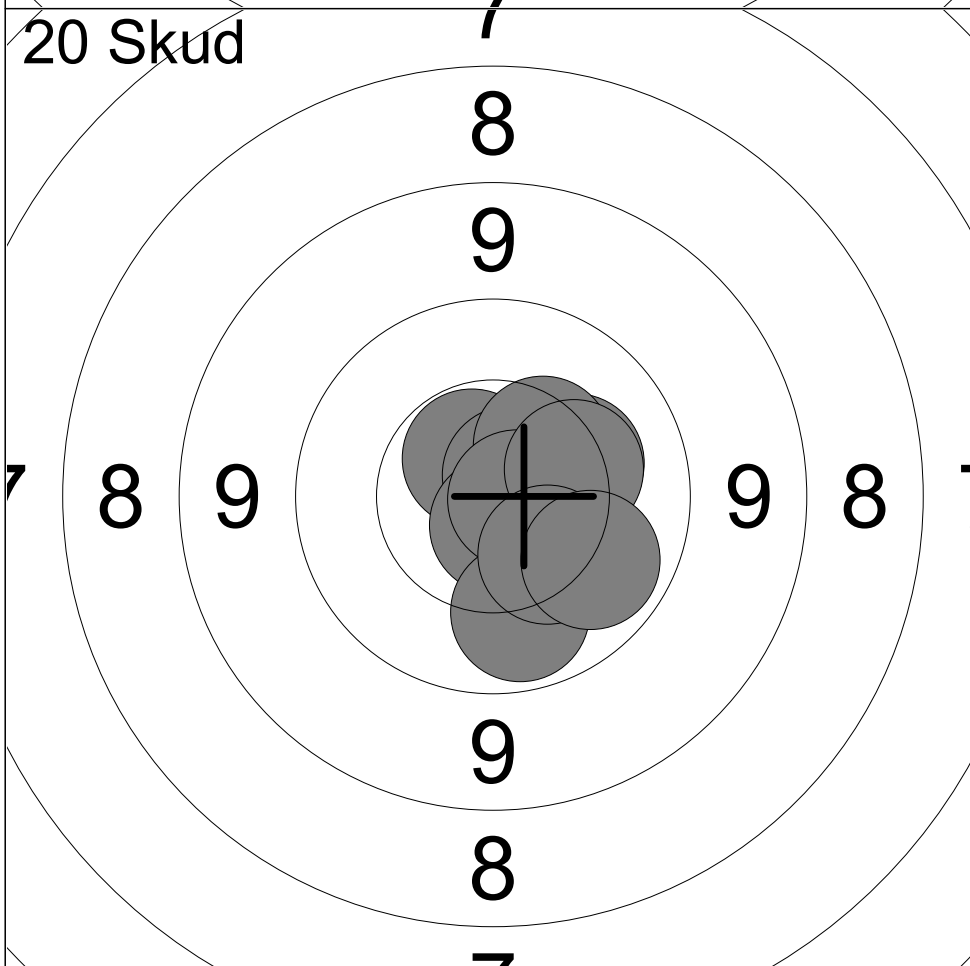

11:	10.6x	↖
12:	10.7x	↗
13:	10.3	→
14:	10.4	↗
15:	10.7x	↘
16:	10.8x	→
17:	10.0	↘
18:	10.3	↗
19:	10.3	↘
20:	10.0	↘

Serie	100 (4x)
Total	200 (7x)

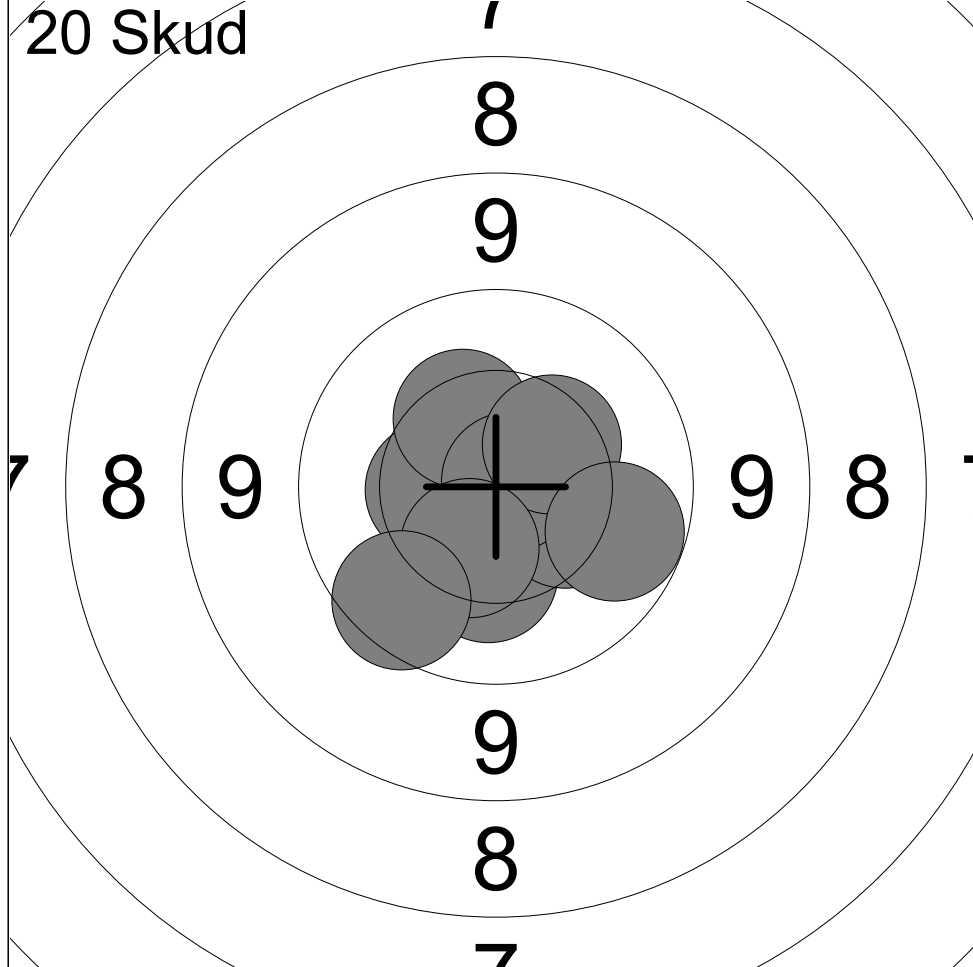

1:	10.3	↓
2:	10.9x	↗
3:	10.5	←
4:	10.4	↘
5:	10.4	↖
6:	10.8x	→
7:	10.4	↗
8:	10.4	↘
9:	9.8	↙
10:	10.0	↘

Serie	99 (2x)
Total	99 (2x)

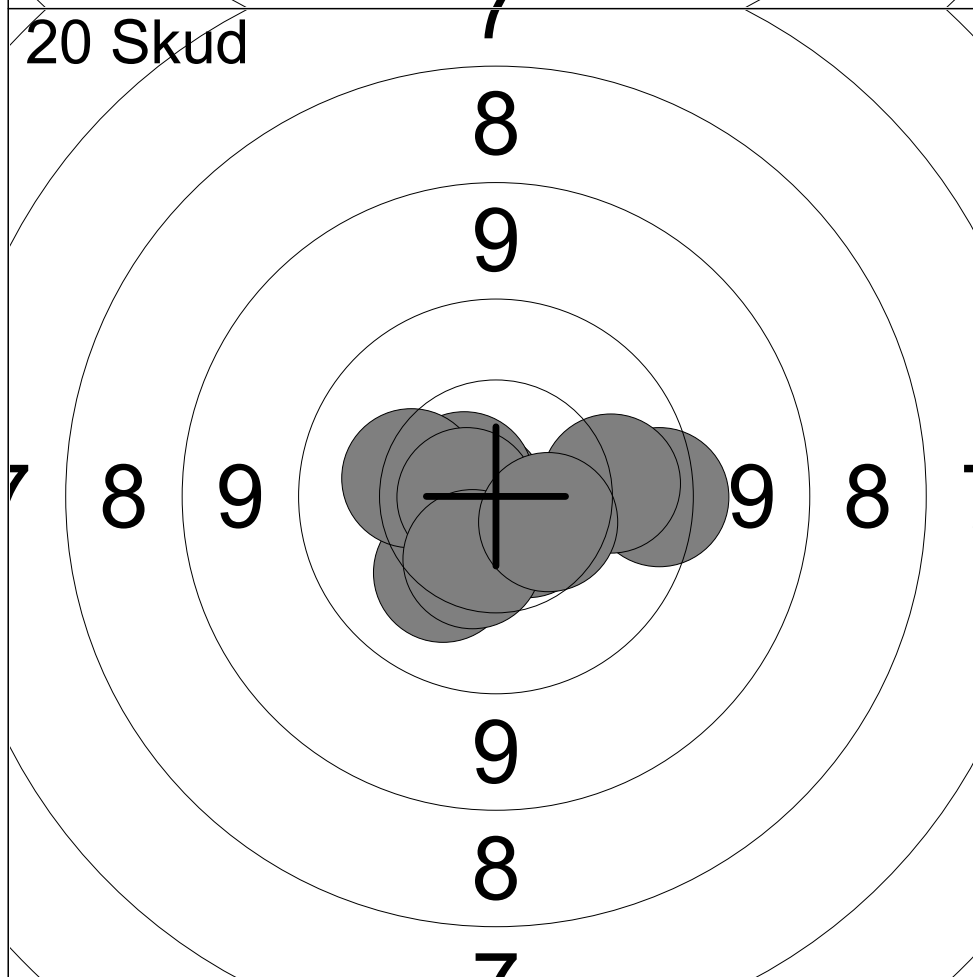

11:	10.8x	←
12:	9.6	→
13:	10.7x	↖
14:	10.2	↘
15:	10.3	←
16:	10.6x	↘
17:	10.7x	←
18:	10.0	→
19:	10.4	↘
20:	10.5	↘

Serie	99 (4x)
Total	198 (6x)

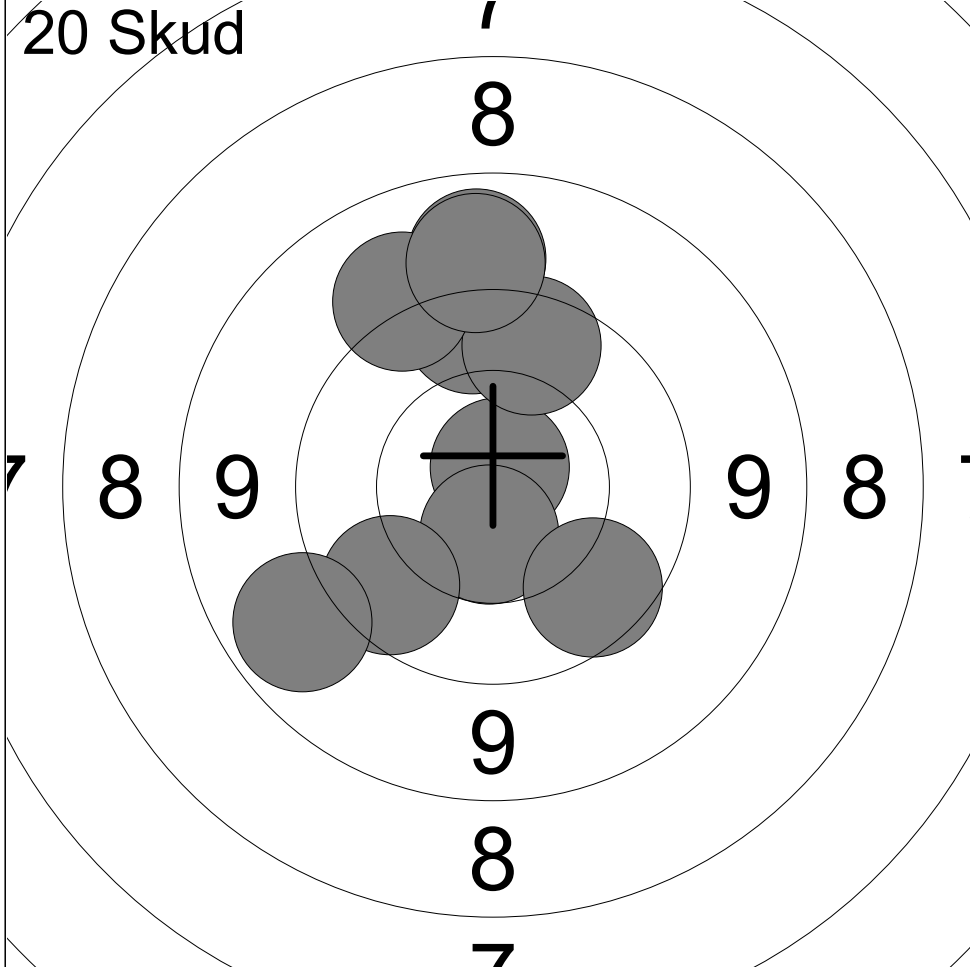

1:	9.1	↑
2:	9.6	↑
3:	10.8x	↗
4:	9.8	↑
5:	9.3	↖
6:	9.1	↑
7:	10.6	↓
8:	9.8	↙
9:	9.8	↘
10:	9.0	↙

Serie	92 (1x)
Total	92 (1x)

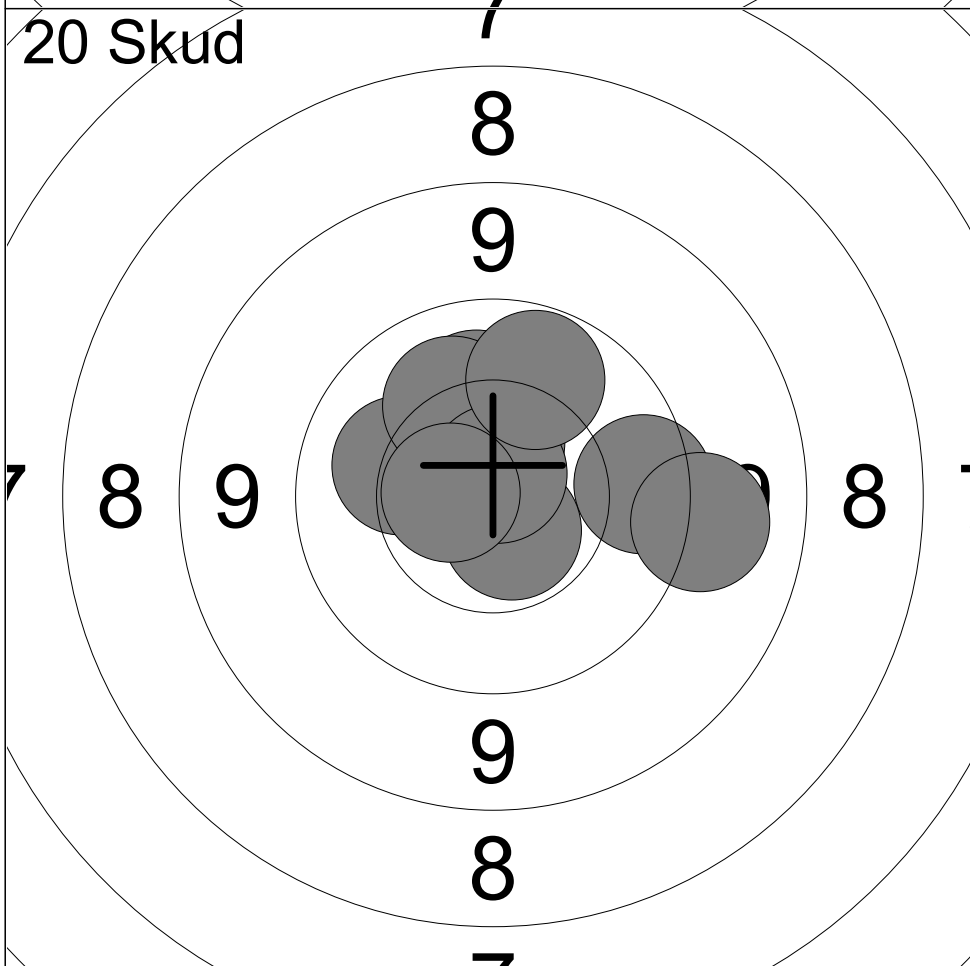

11:	9.8	→
12:	10.2	↖
13:	10.2	↑
14:	9.3	→
15:	10.5	↑
16:	10.2	↖
17:	10.6x	↘
18:	10.8x	↑
19:	10.6x	←
20:	10.0	↗

Serie	98 (3x)
Total	190 (4x)

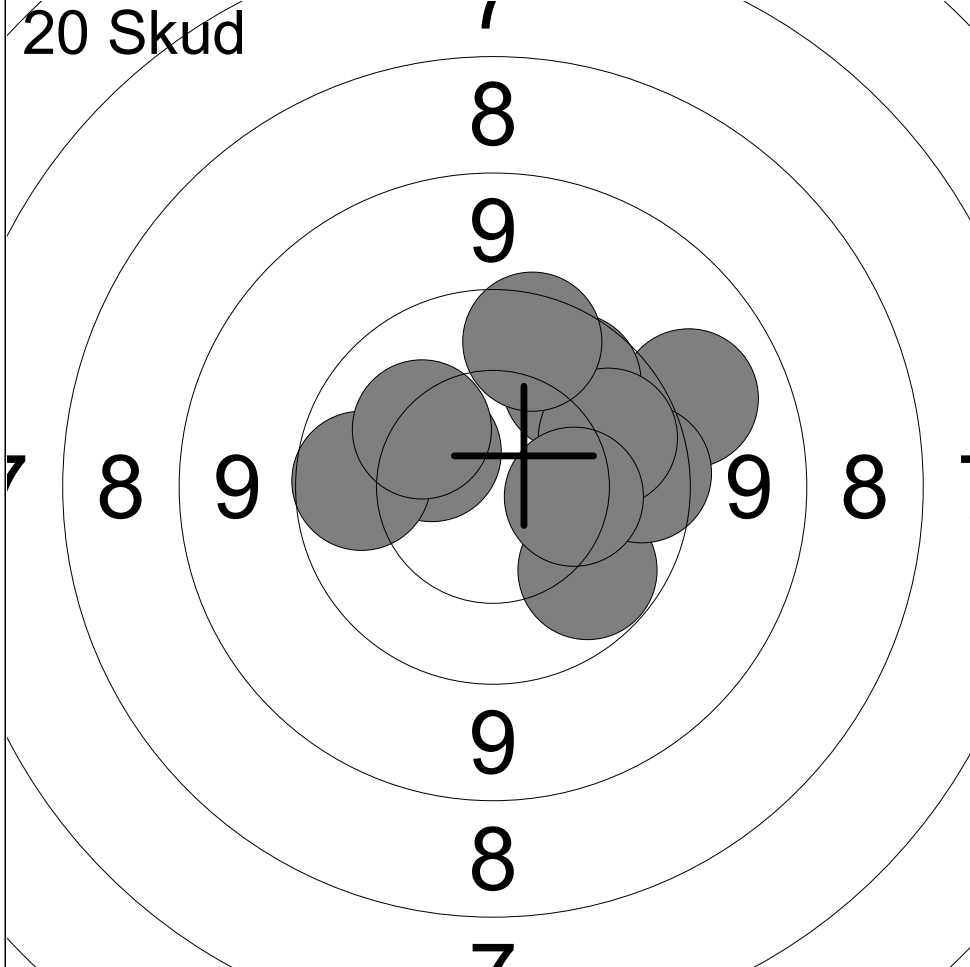

1:	10.0	↘
2:	9.2	↗
3:	9.8	→
4:	9.9	↗
5:	10.4	↖
6:	9.9	←
7:	10.2	↗
8:	10.0	↗
9:	9.8	↗
10:	10.3	→

Serie	95 (0x)
Total	95 (0x)

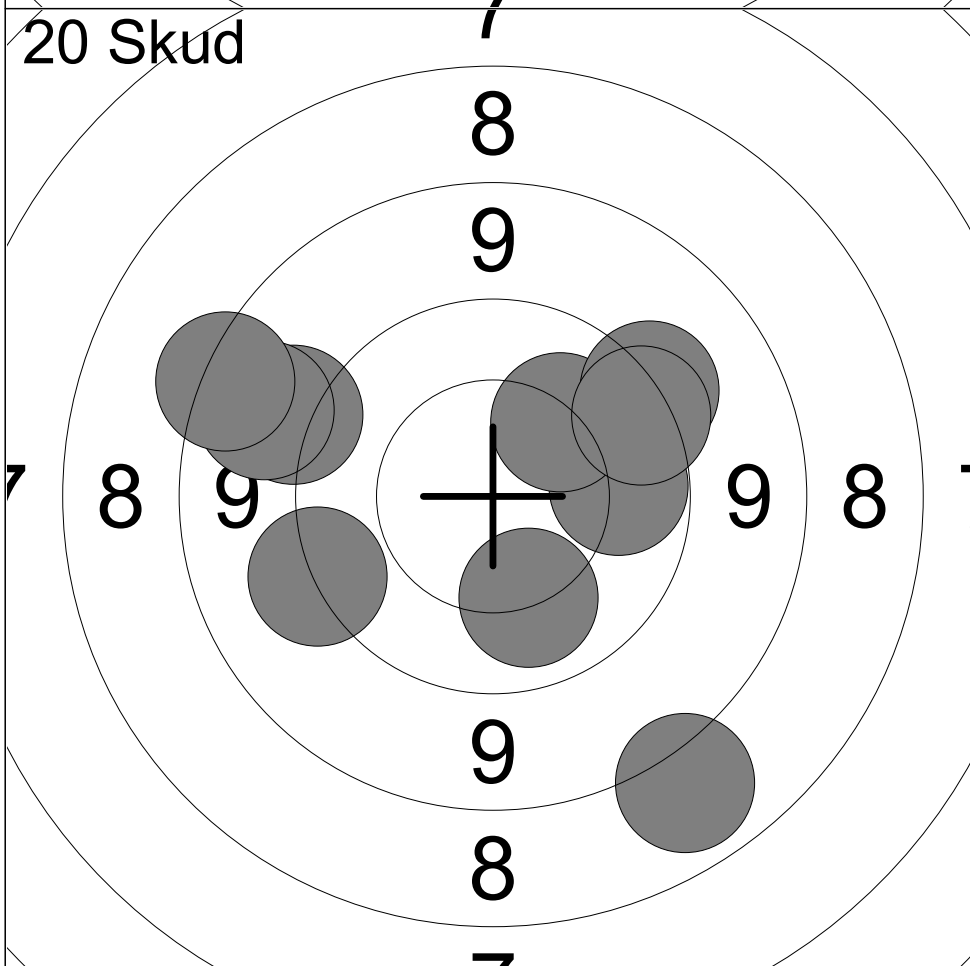

11:	10.1	↘
12:	10.0	→
13:	9.2	↖
14:	10.2	↗
15:	8.9	↖
16:	8.1	↘
17:	9.4	←
18:	9.4	↗
19:	9.6	↗
20:	8.5	↖

Serie	90 (0x)
Total	185 (0x)

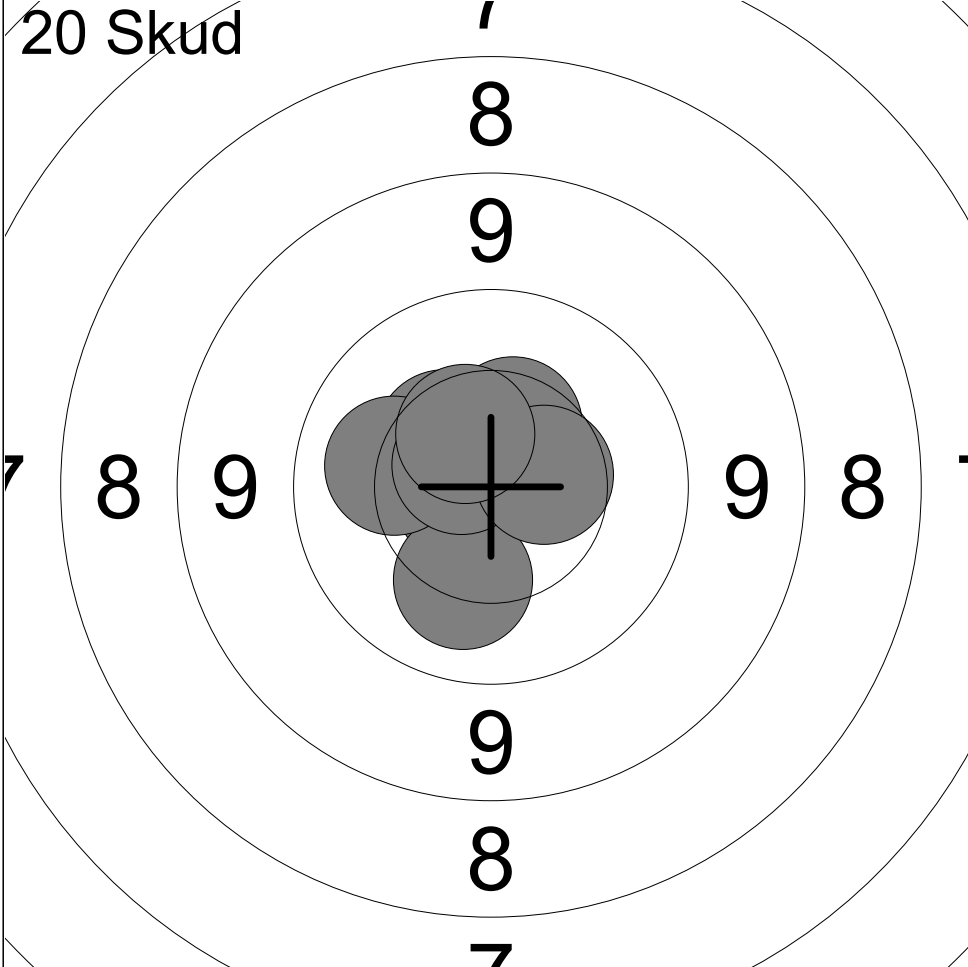

1:	10.6	↑
2:	10.4	↗
3:	10.5	↖
4:	10.7x	↙
5:	10.4	↗
6:	10.2	↘
7:	10.2	↖
8:	10.7x	↗
9:	10.5	↗
10:	10.5	↗

Serie	100 (2x)
Total	100 (2x)

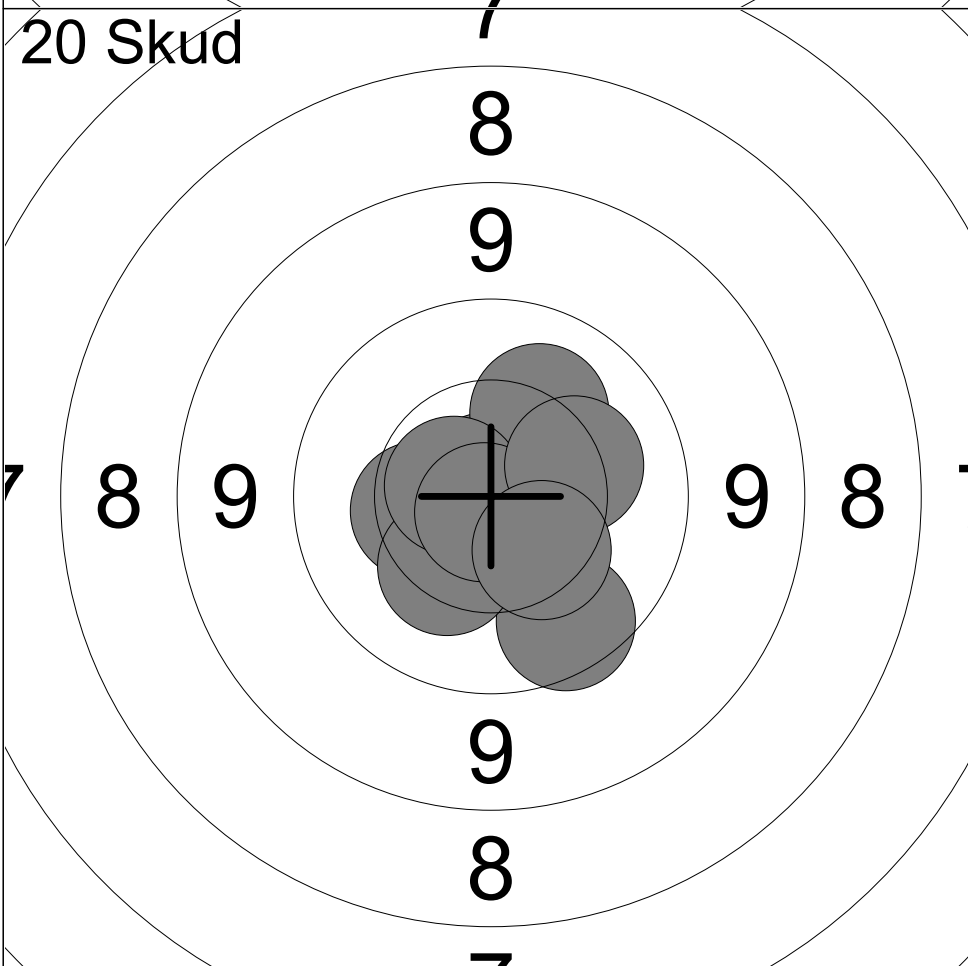

11:	10.3	↗
12:	9.8	↘
13:	10.4	↖
14:	10.3	↙
15:	10.8x	↗
16:	10.2	↗
17:	10.6x	↖
18:	10.8x	↘
19:	10.3	↗
20:	10.4	↘

Serie	99 (3x)
Total	199 (5x)

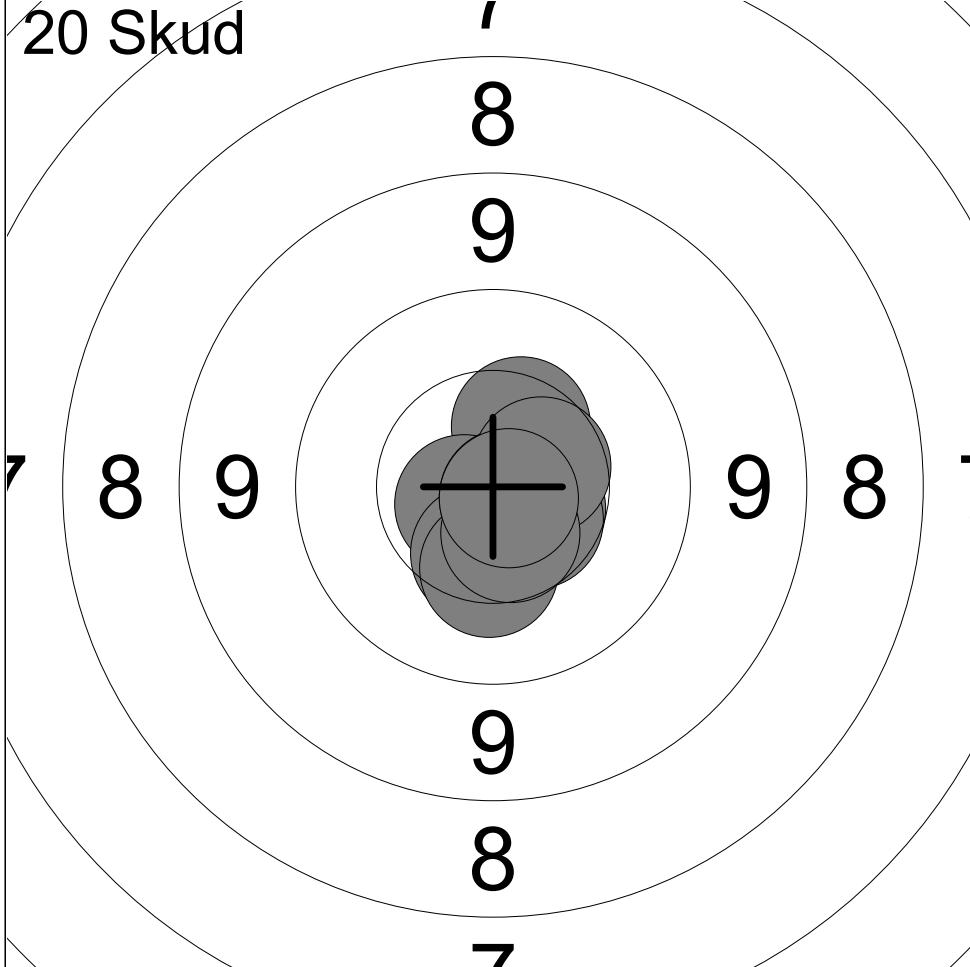

1:	10.6	↘
2:	10.5	↘
3:	10.4	↗
4:	10.7x	↙
5:	10.4	↘
6:	10.8x	↘
7:	10.3	↘
8:	10.5	↗
9:	10.6	↘
10:	10.8x	↘

Serie	100 (3x)
Total	100 (3x)

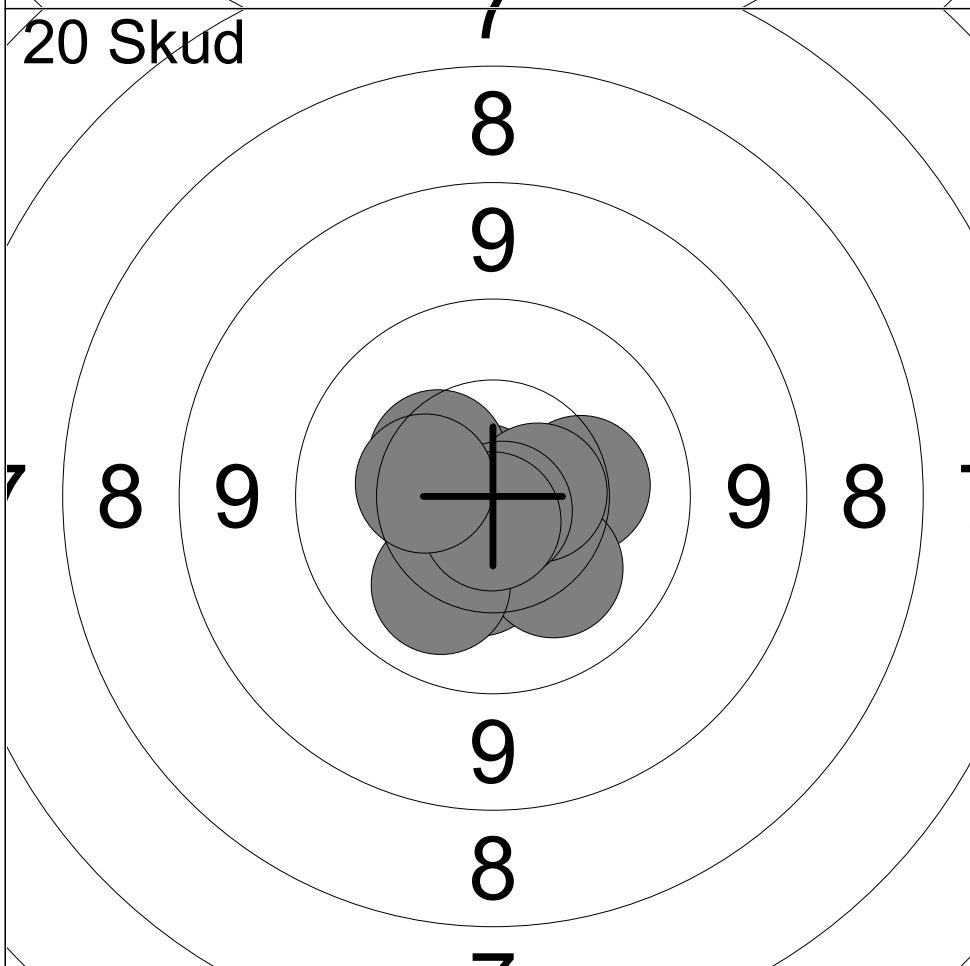

11:	10.4	↘
12:	10.3	→
13:	10.8x	↖
14:	10.2	↘
15:	10.4	↗
16:	10.6x	→
17:	10.8x	↘
18:	10.1	↘
19:	10.8x	↘
20:	10.4	↖

Serie	100 (4x)
Total	200 (7x)

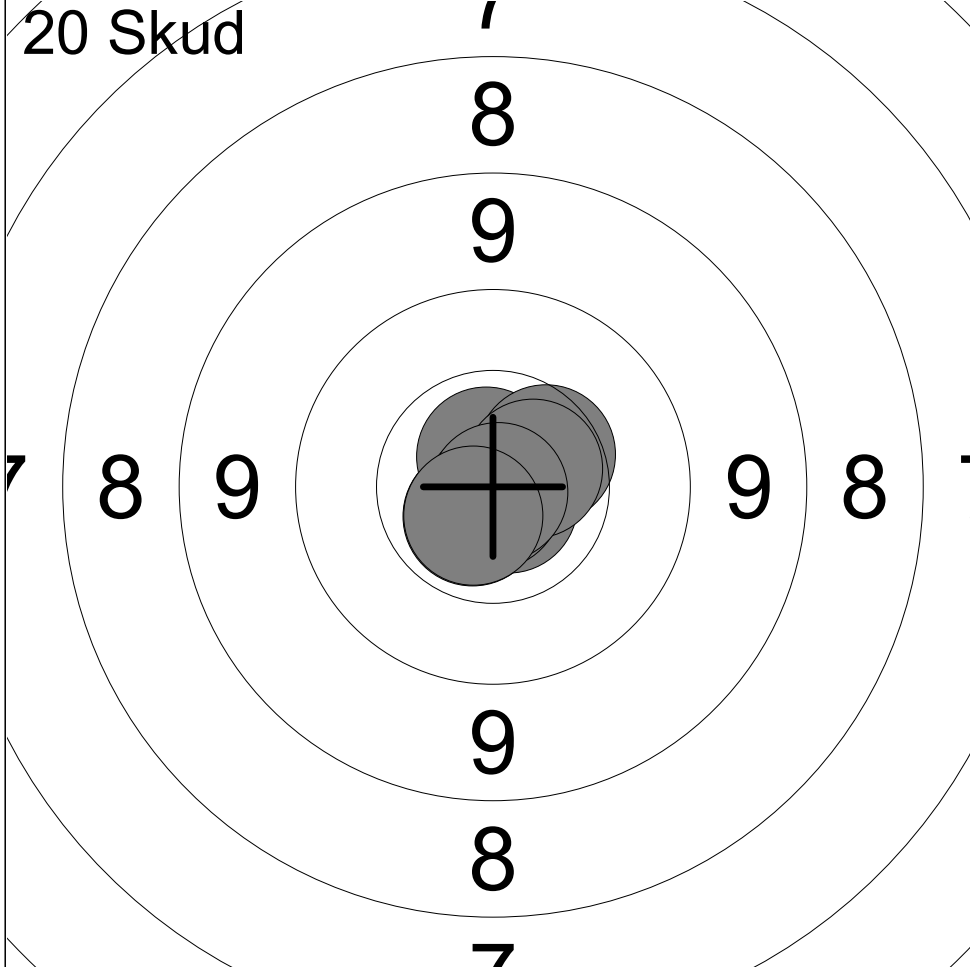

1:	10.8x	↘
2:	10.9x	↖
3:	10.7x	↙
4:	10.8x	↘
5:	10.7x	↗
6:	10.5	↗
7:	10.6x	↗
8:	10.9x	↓
9:	10.9x	↘
10:	10.7x	↙

Serie	100 (9x)
Total	100 (9x)



11:	10.7x	↘
12:	10.8x	↗
13:	10.7x	↘
14:	10.7x	↙
15:	10.7x	↖
16:	10.3	↗
17:	10.4	→
18:	10.6	↖
19:	10.6x	↗
20:	10.7x	←

Serie	100 (7x)
Total	200 (16x)

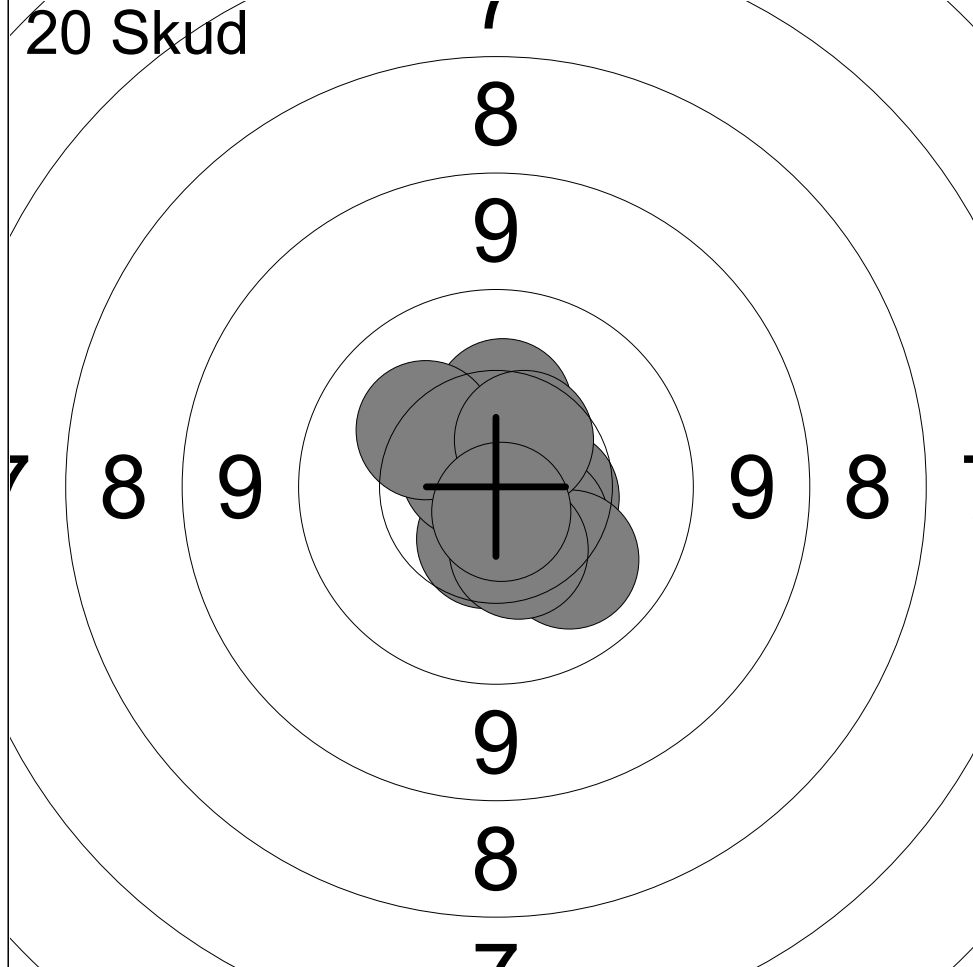

1:	10.5	→
2:	10.5	↓
3:	10.5	↘
4:	10.3	↑
5:	10.7x	↗
6:	10.1	↘
7:	10.2	↗
8:	10.5	↗
9:	10.4	↓
10:	10.7x	↓

Serie	100 (2x)
Total	100 (2x)

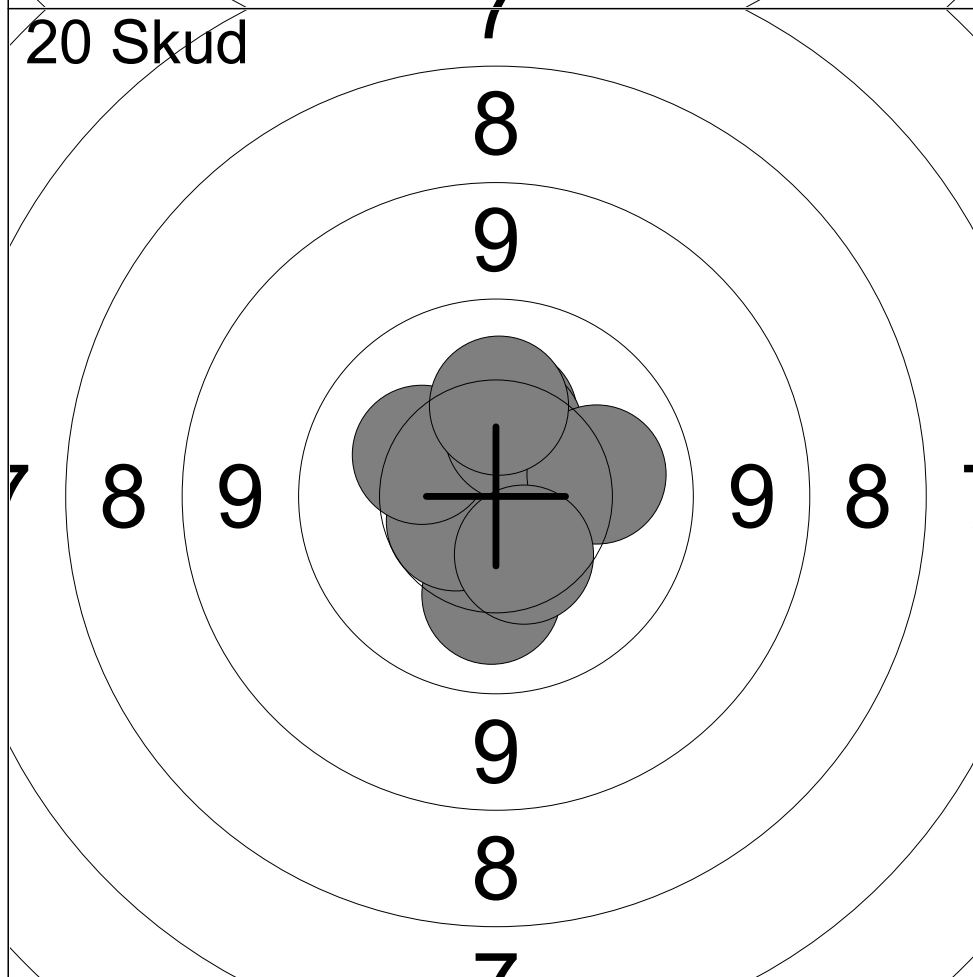

11:	10.6x	↓
12:	10.7x	↓
13:	10.2	↓
14:	10.6	↖
15:	10.3	↖
16:	10.3	↑
17:	10.4	↑
18:	10.1	→
19:	10.4	↓
20:	10.2	↑

Serie	100 (2x)
Total	200 (4x)

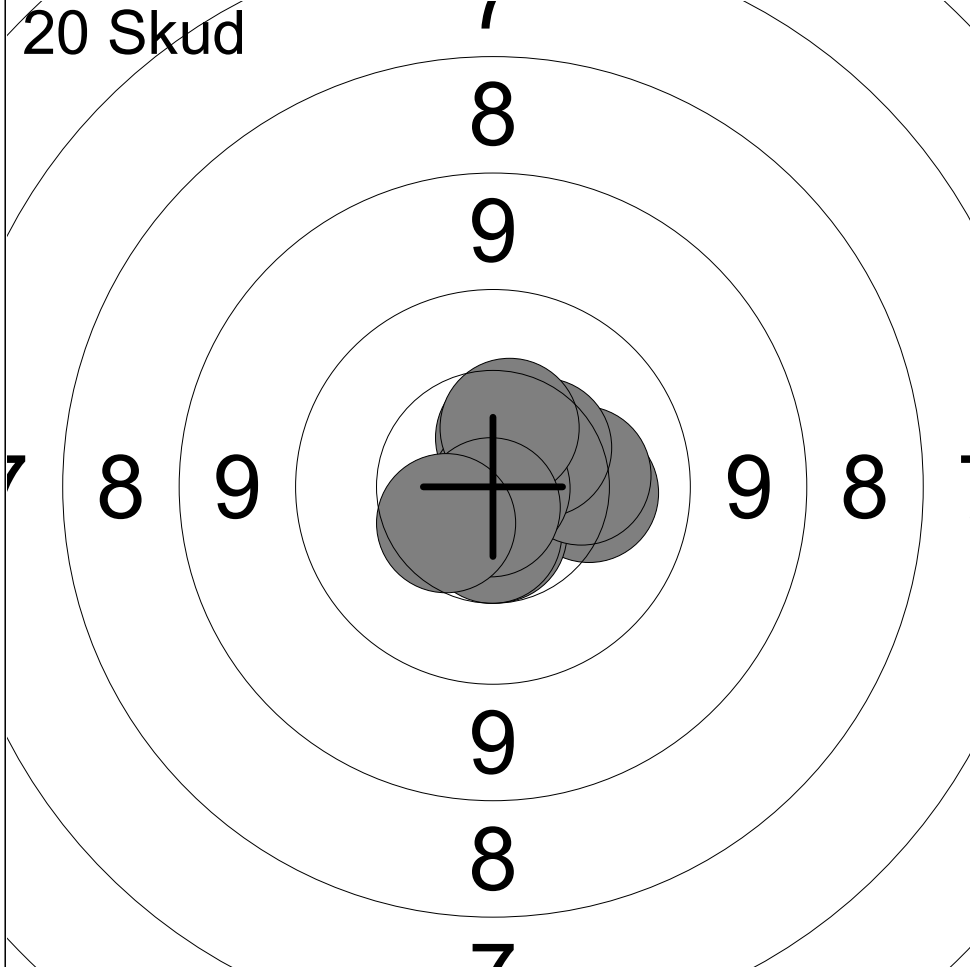

1:	10.2	→
2:	10.6	↓
3:	10.6	↑
4:	10.6	↓
5:	10.3	→
6:	10.5	↗
7:	10.9x	→
8:	10.5	↑
9:	10.8x	↓
10:	10.5	↙

Serie	100 (2x)
Total	100 (2x)

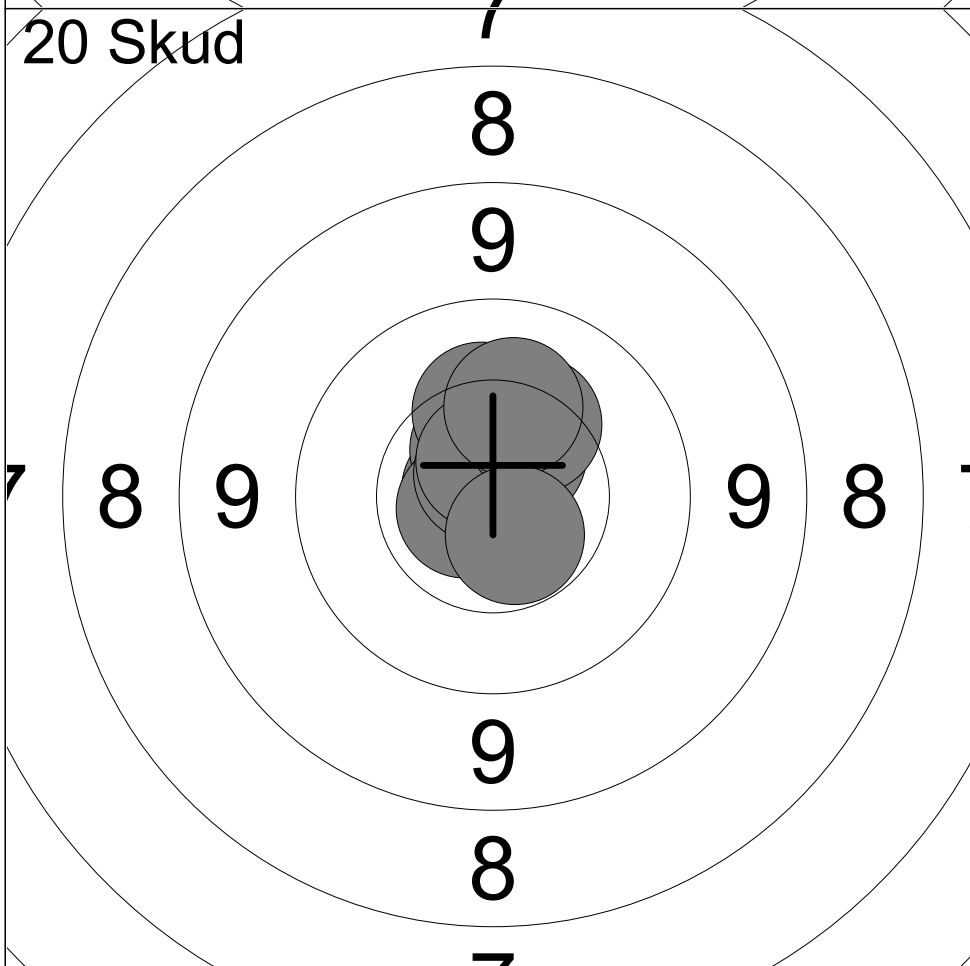

11:	10.8x	↖
12:	10.6	↑
13:	10.7x	↖
14:	10.3	↑
15:	10.8x	↑
16:	10.6	↗
17:	10.7x	↑
18:	10.3	↗
19:	10.2	↑
20:	10.6x	↓

Serie	100 (5x)
Total	200 (7x)

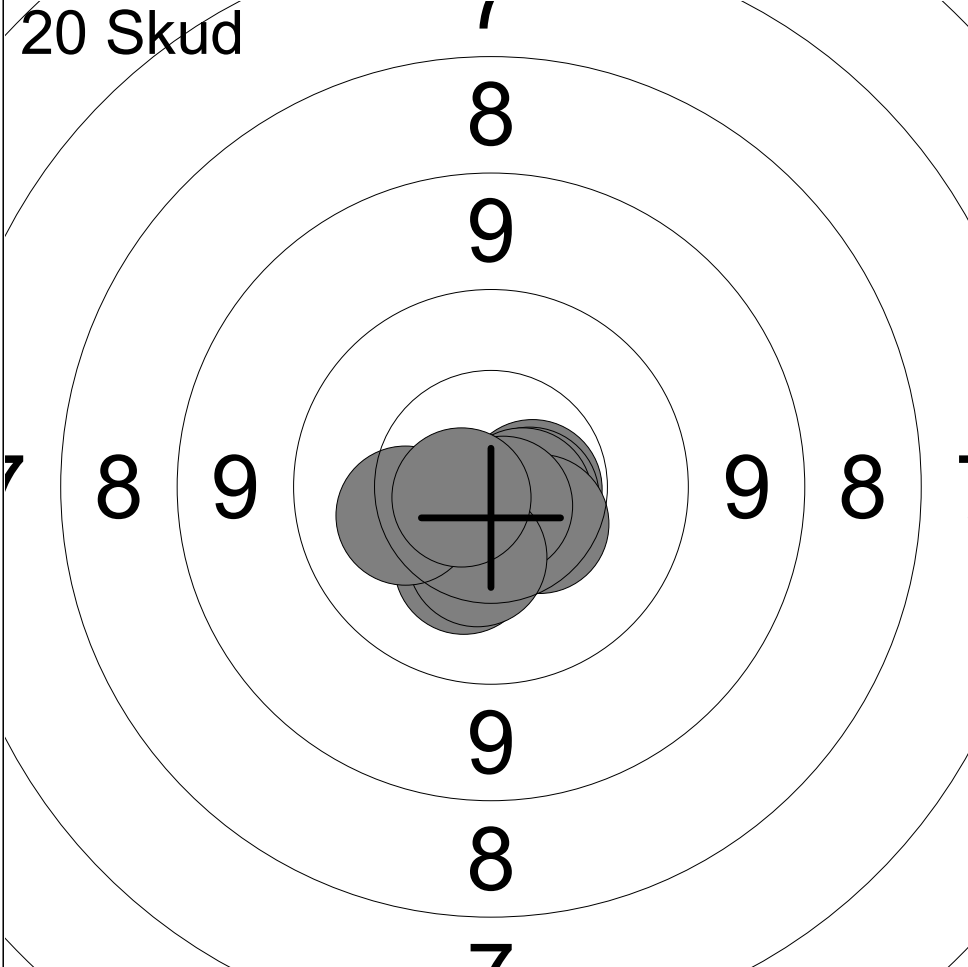

1:	10.4	↘
2:	10.6x	→
3:	10.6x	→
4:	10.7x	→
5:	10.5	↘
6:	10.3	↘
7:	10.8x	↘
8:	10.4	↘
9:	10.2	←
10:	10.7x	←

Serie	100 (5x)
Total	100 (5x)

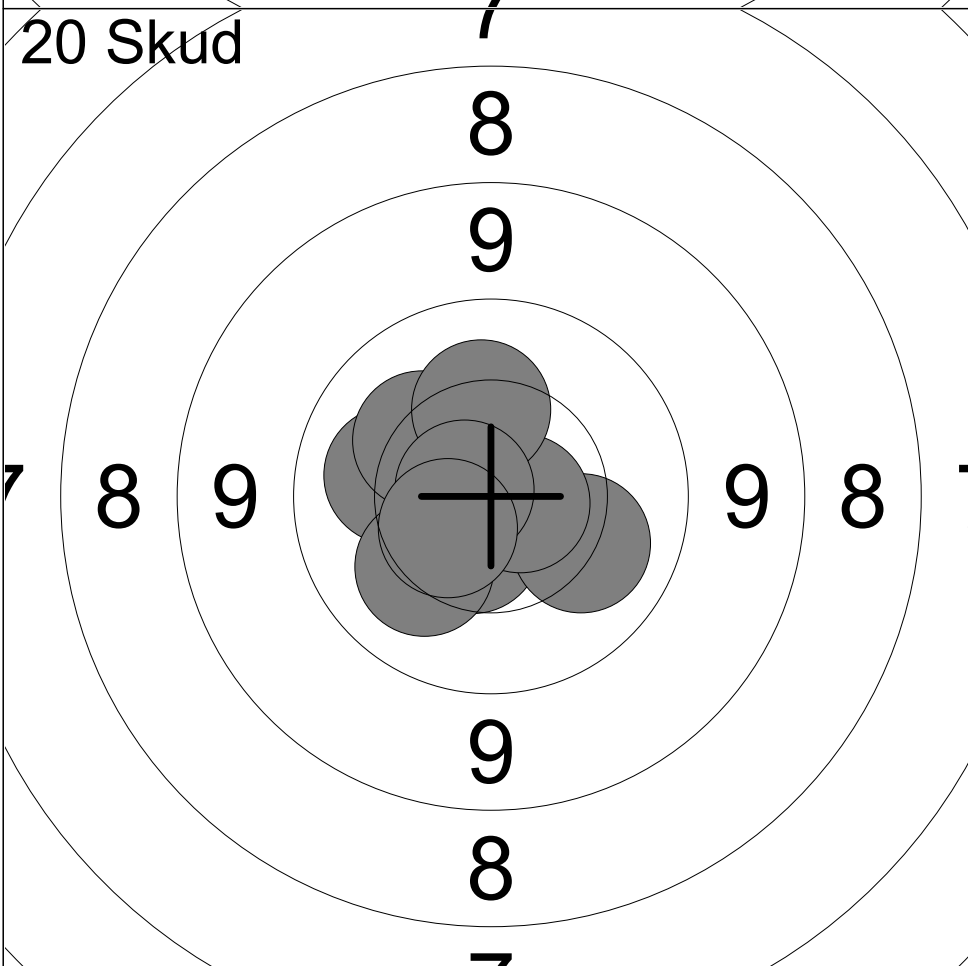

11:	10.6	↘
12:	10.2	←
13:	10.2	↘
14:	10.2	↘
15:	10.7x	→
16:	10.4	↗
17:	10.3	↗
18:	10.3	↗
19:	10.7x	←
20:	10.5	↘

Serie	100 (2x)
Total	200 (7x)

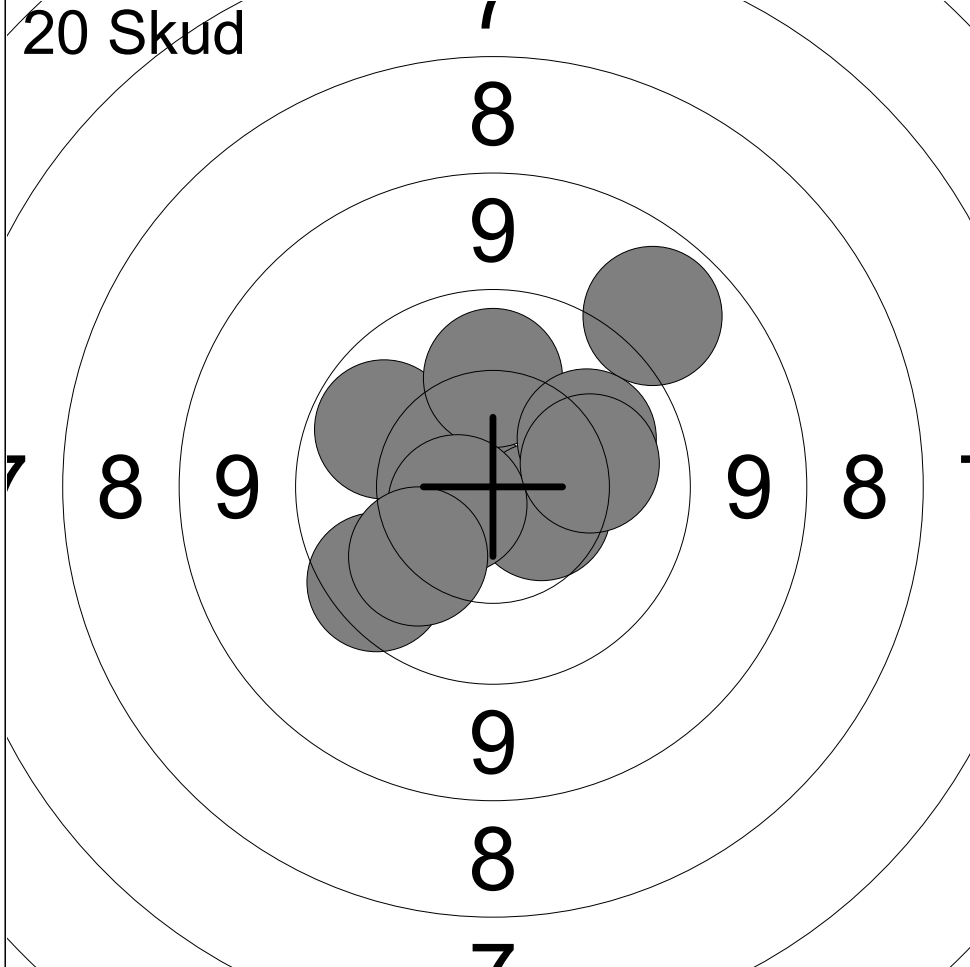

1:	9.8	↙
2:	10.7x	←
3:	10.0	↖
4:	9.0	↗
5:	10.1	↑
6:	10.5	↘
7:	10.6x	↙
8:	10.1	↗
9:	10.1	↙
10:	10.2	→

Serie	98 (2x)
Total	98 (2x)

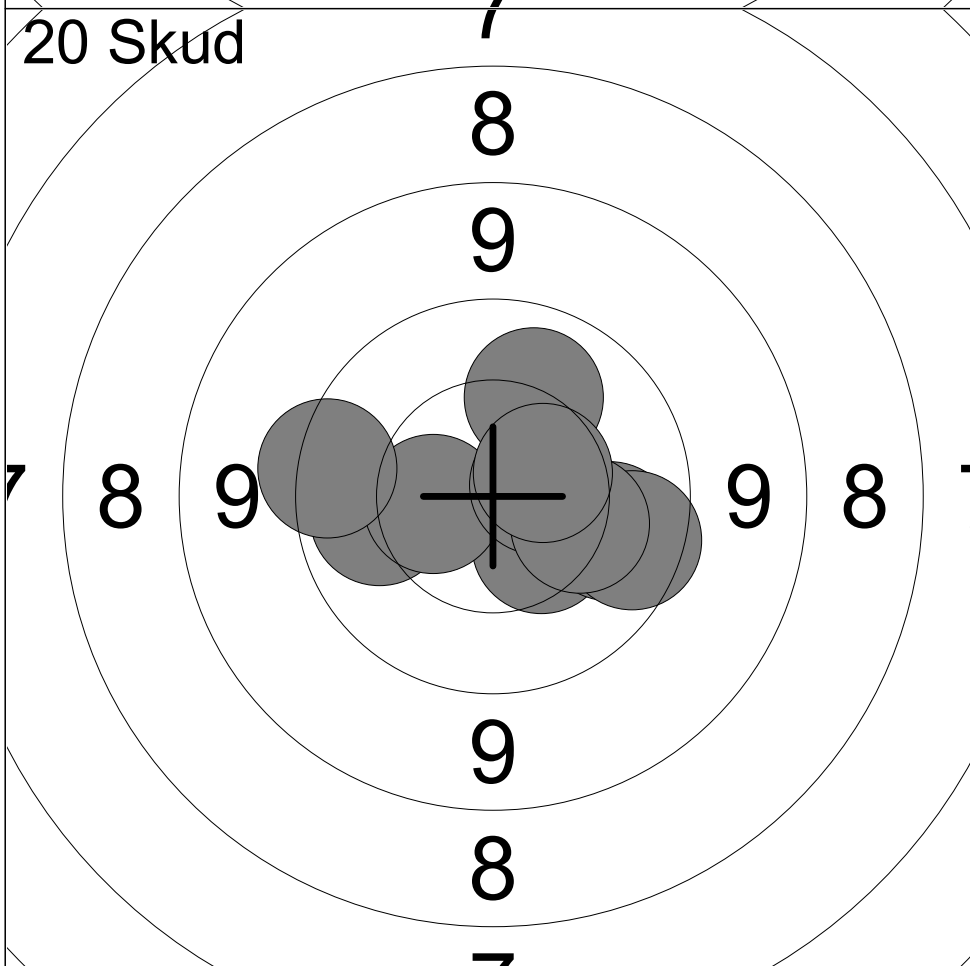

11:	10.4	↘
12:	10.0	←
13:	10.1	↗
14:	10.5	←
15:	10.0	↘
16:	9.6	←
17:	9.8	↘
18:	10.6	↗
19:	10.2	↘
20:	10.5	↗

Serie	98 (0x)
Total	196 (2x)

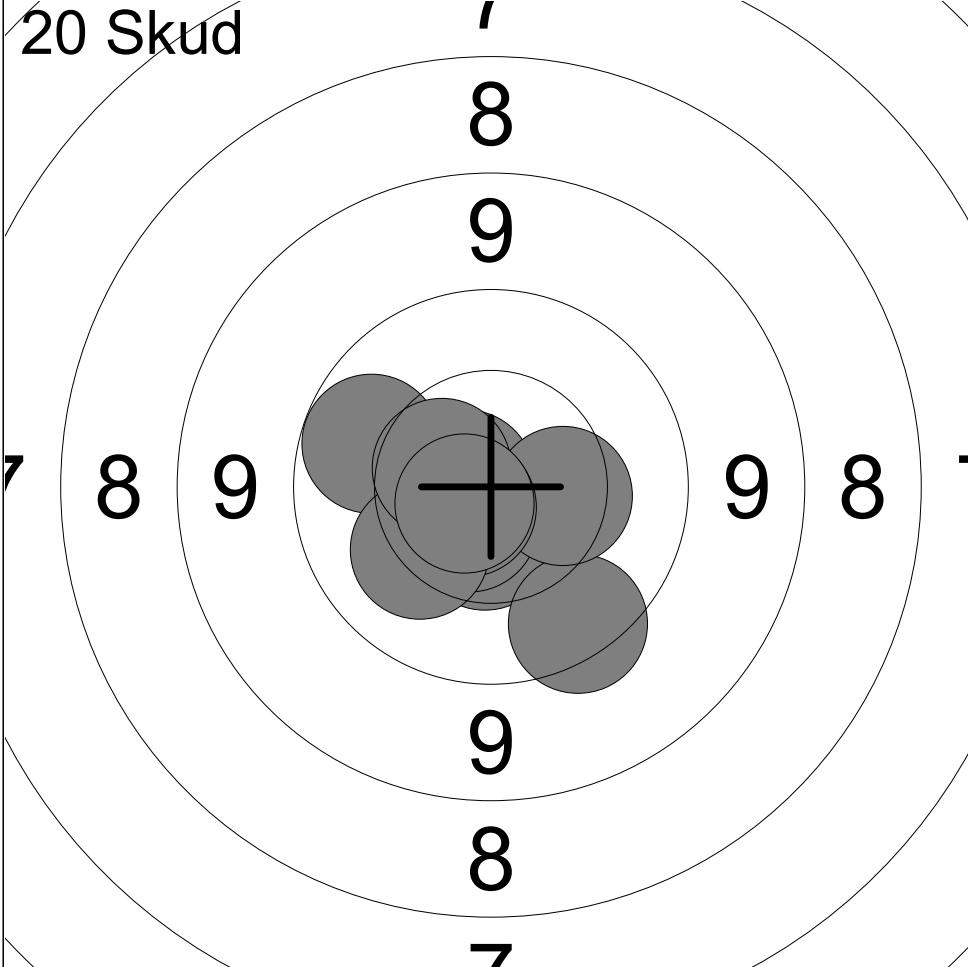

1:	10.7x	←
2:	10.5	↓
3:	9.7	↘
4:	10.6x	↘
5:	10.4	→
6:	10.0	←
7:	10.7x	↙
8:	10.2	↙
9:	10.5	←
10:	10.7x	↙

Serie	99 (4x)
Total	99 (4x)



11:	10.0	↘
12:	10.8x	↗
13:	9.8	←
14:	10.3	↘
15:	10.4	↗
16:	10.2	↗
17:	10.6	→
18:	10.2	↑
19:	10.7x	↙
20:	10.3	↘

Serie	99 (2x)
Total	198 (6x)

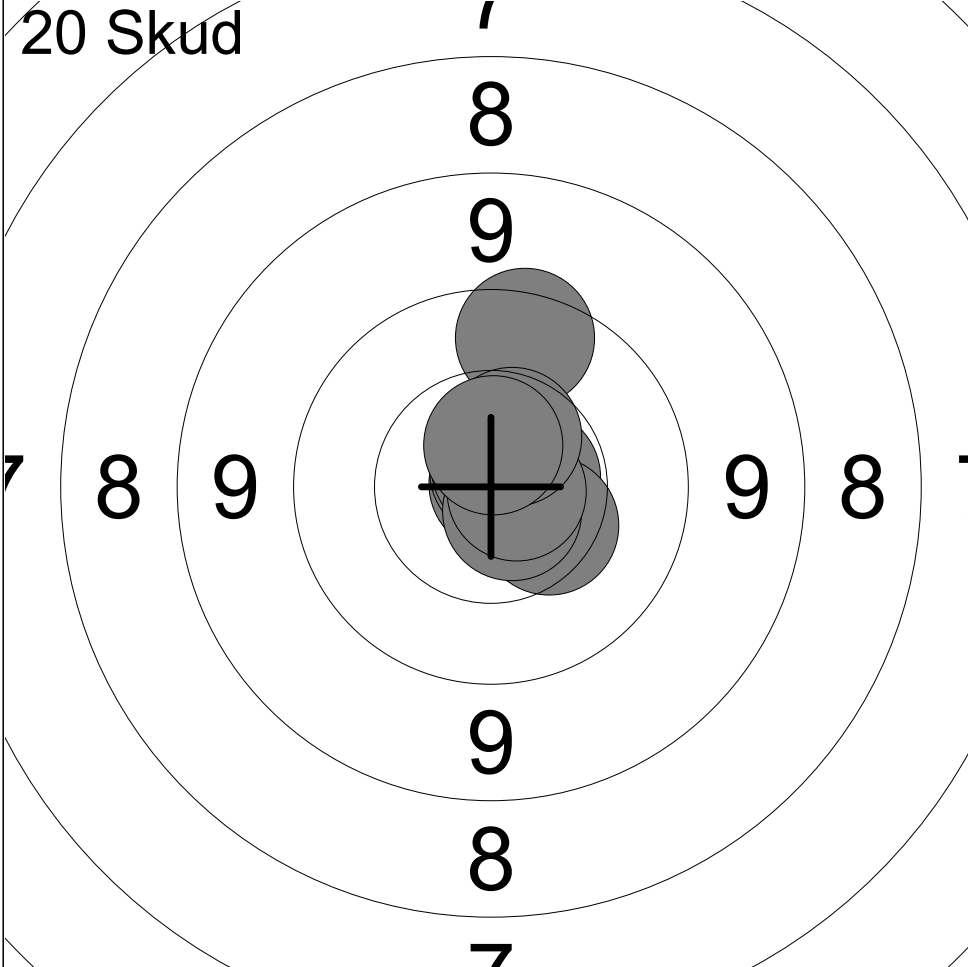

1:	10.6x	→
2:	10.9x	→
3:	10.8x	↗
4:	10.4	↘
5:	10.8x	↗
6:	9.7	↗
7:	10.7x	↘
8:	10.7x	→
9:	10.5	↗
10:	10.6x	↑

Serie	99 (7x)
Total	99 (7x)



11:	10.3	↗
12:	10.8x	↓
13:	10.5	→
14:	10.5	↘
15:	10.8x	↓
16:	10.5	↗
17:	10.3	↗
18:	10.6x	→
19:	10.5	↑
20:	10.7x	↓

Serie	100 (4x)
Total	199 (11x)

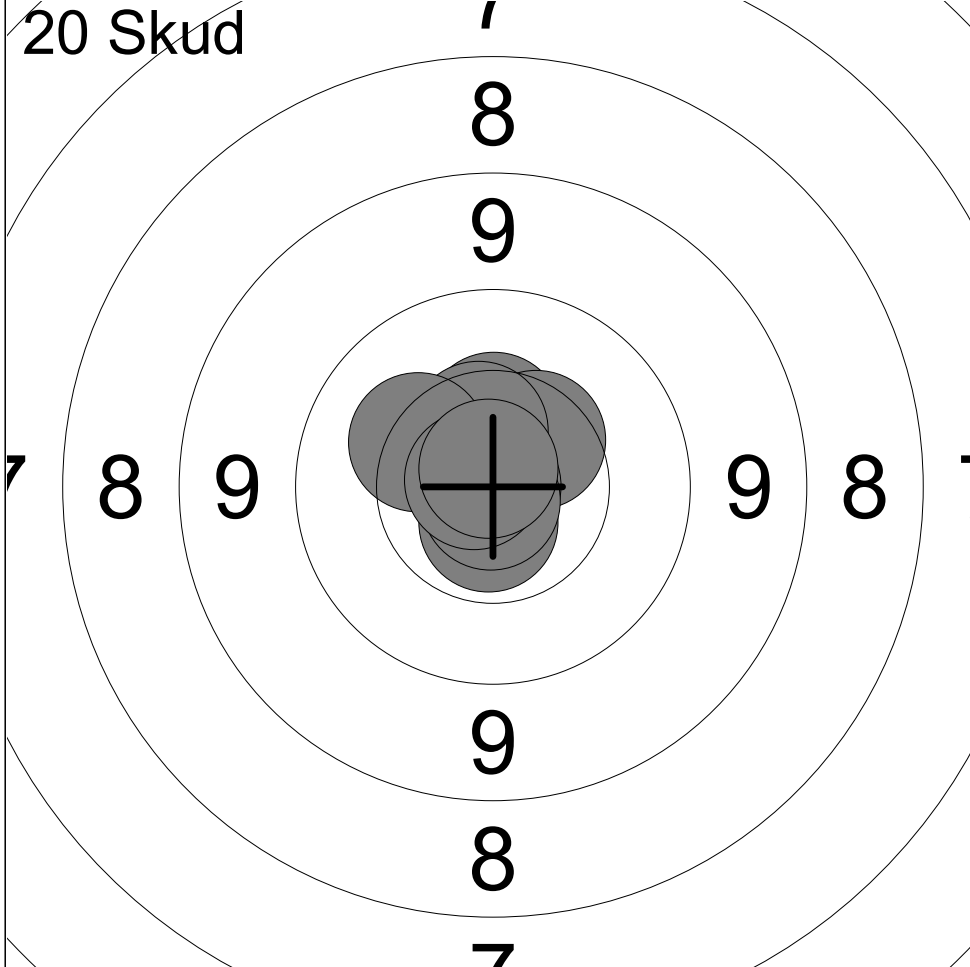

1:	10.4	↑
2:	10.5	↗
3:	10.5	↑
4:	10.9x	↗
5:	10.7x	↓
6:	10.3	↖
7:	10.9x	←
8:	10.8x	↓
9:	10.8x	↖
10:	10.8x	↑

Serie	100 (6x)
Total	100 (6x)

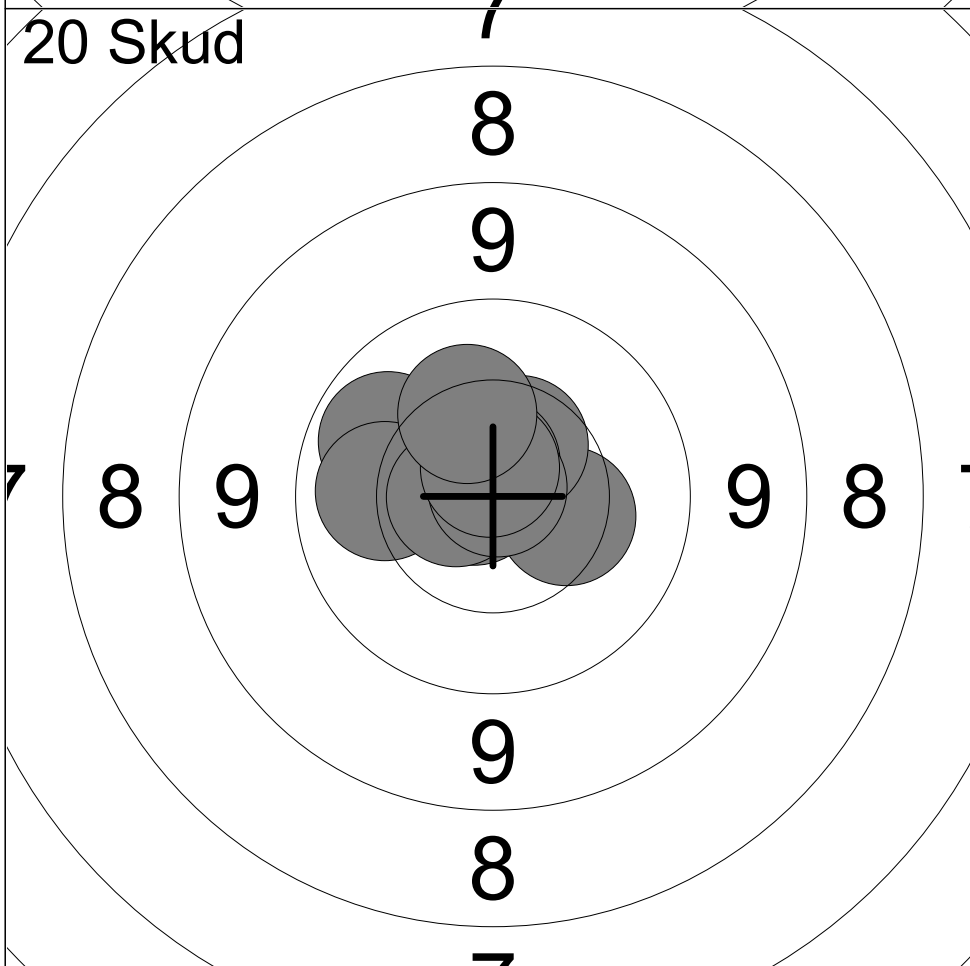

11:	10.0	↖
12:	10.1	←
13:	10.8x	←
14:	10.7x	←
15:	10.4	→
16:	10.5	↗
17:	10.7x	↑
18:	10.9x	↗
19:	10.7x	↑
20:	10.3	↖

Serie	100 (5x)
Total	200 (11x)

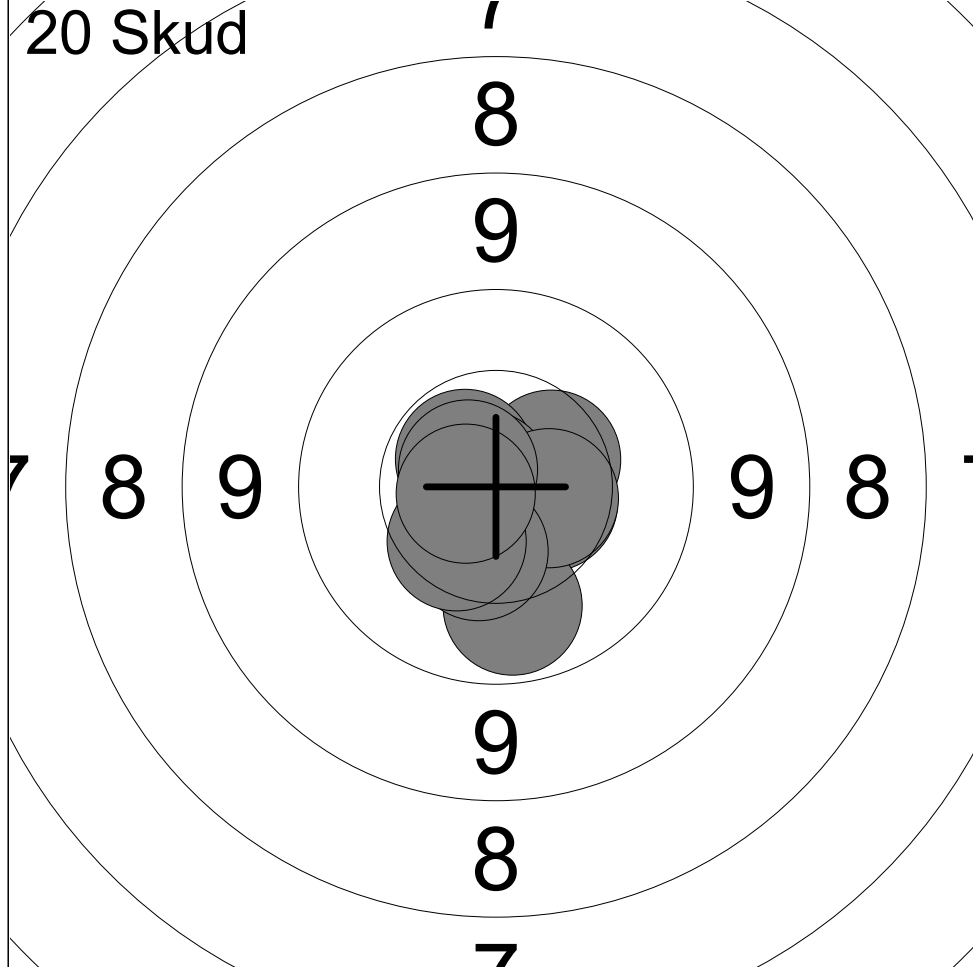

1:	10.5	↗
2:	10.6x	↖
3:	10.5	→
4:	10.8x	↖
5:	10.0	↓
6:	10.5	→
7:	10.4	↓
8:	10.4	↙
9:	10.7x	↖
10:	10.7x	←

Serie	100 (4x)
Total	100 (4x)

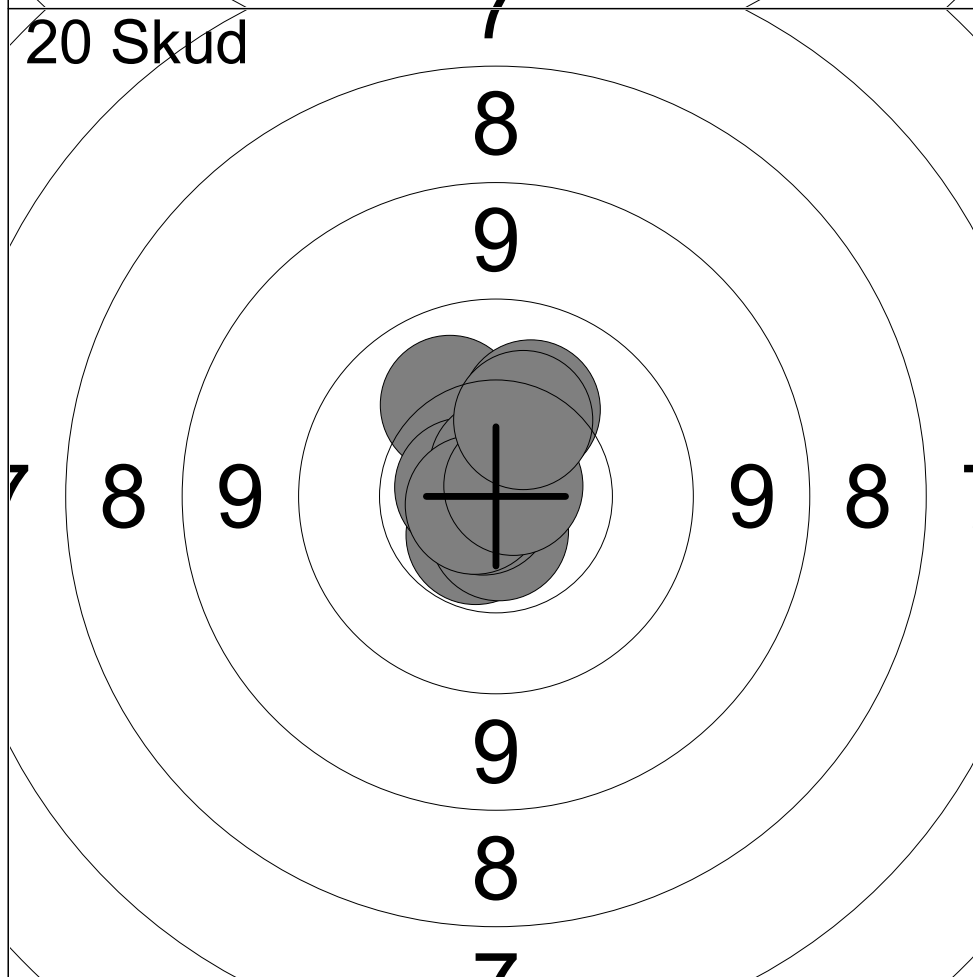

11:	10.1	↖
12:	10.6x	↙
13:	10.7x	←
14:	10.7x	↓
15:	10.2	↗
16:	10.8x	↙
17:	10.7x	↑
18:	10.8x	←
19:	10.8x	↗
20:	10.3	↗

Serie	100 (7x)
Total	200 (11x)

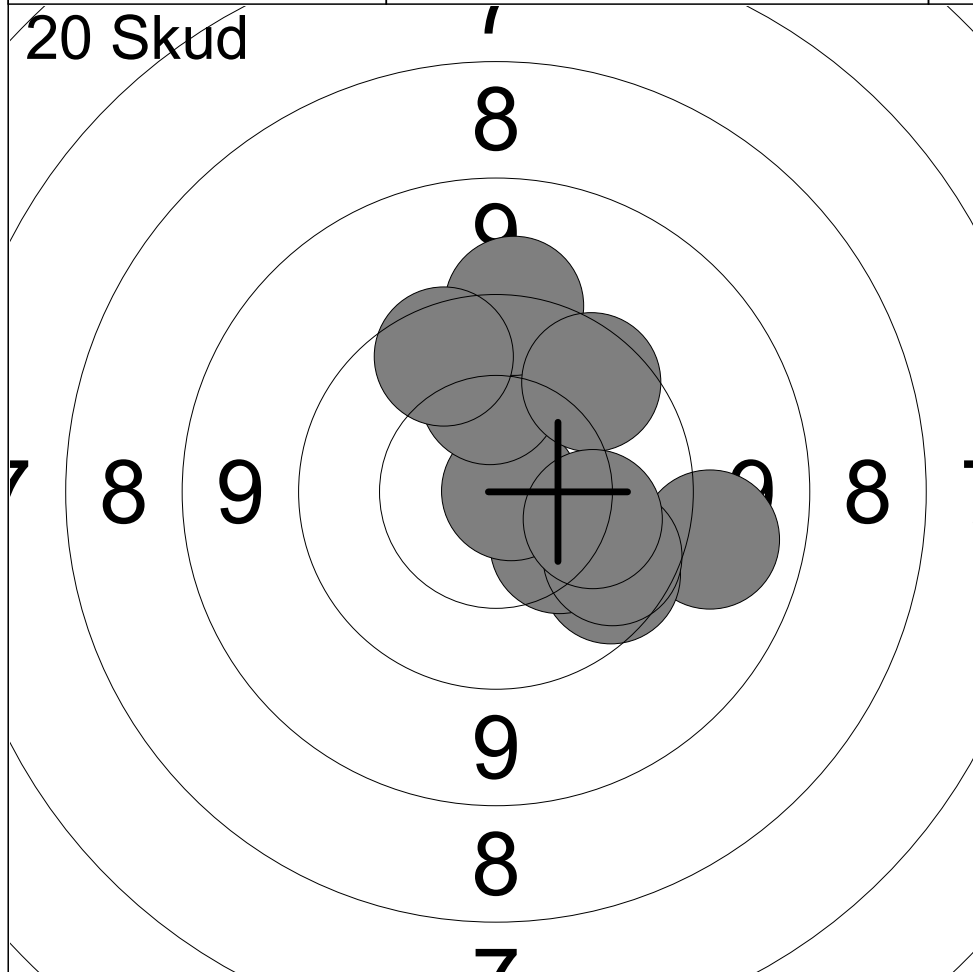

1:	9.2	→
2:	9.8	↘
3:	10.3	↘
4:	10.8x	→
5:	10.2	↑
6:	9.4	↑
7:	9.8	↗
8:	9.8	↗
9:	9.9	↘
10:	10.2	↘

Serie	94 (1x)
Total	94 (1x)

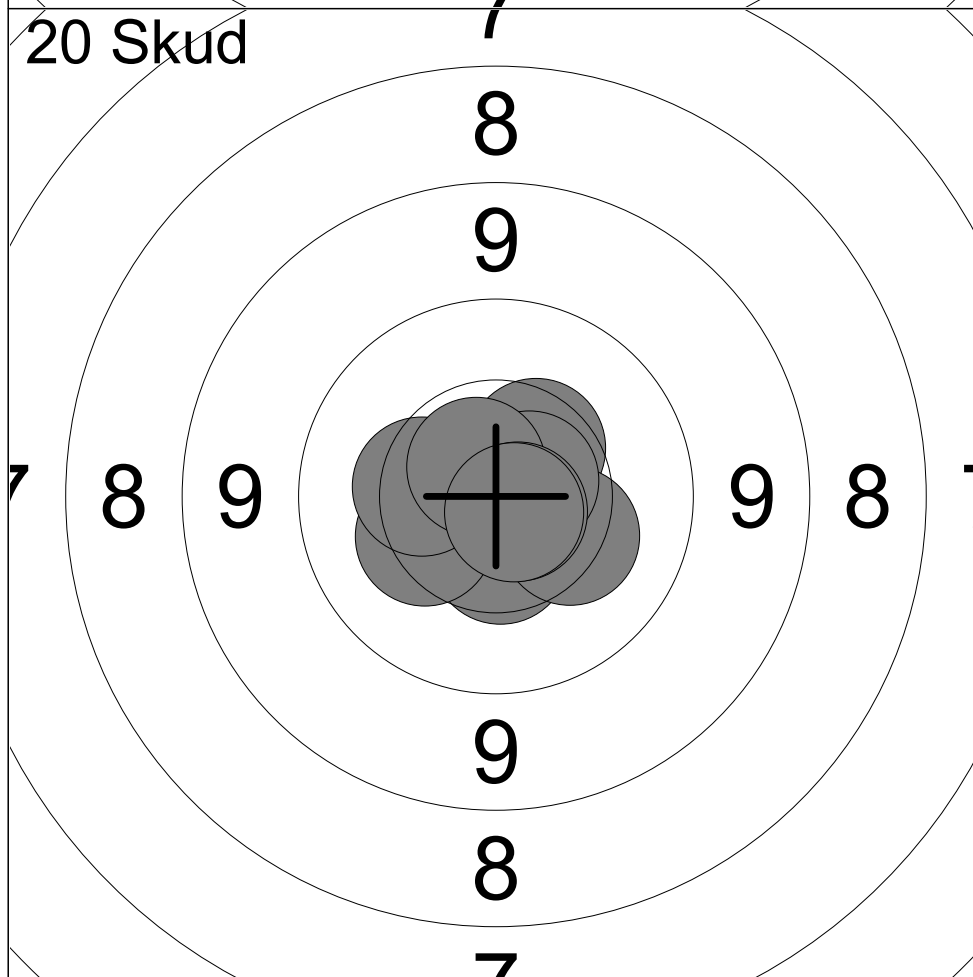

11:	10.9x	↘
12:	10.5	↗
13:	10.5	↓
14:	10.3	↙
15:	10.3	↘
16:	10.7x	↗
17:	10.4	←
18:	10.7x	↗
19:	10.7x	↘
20:	10.8x	↘

Serie	100 (5x)
Total	194 (6x)

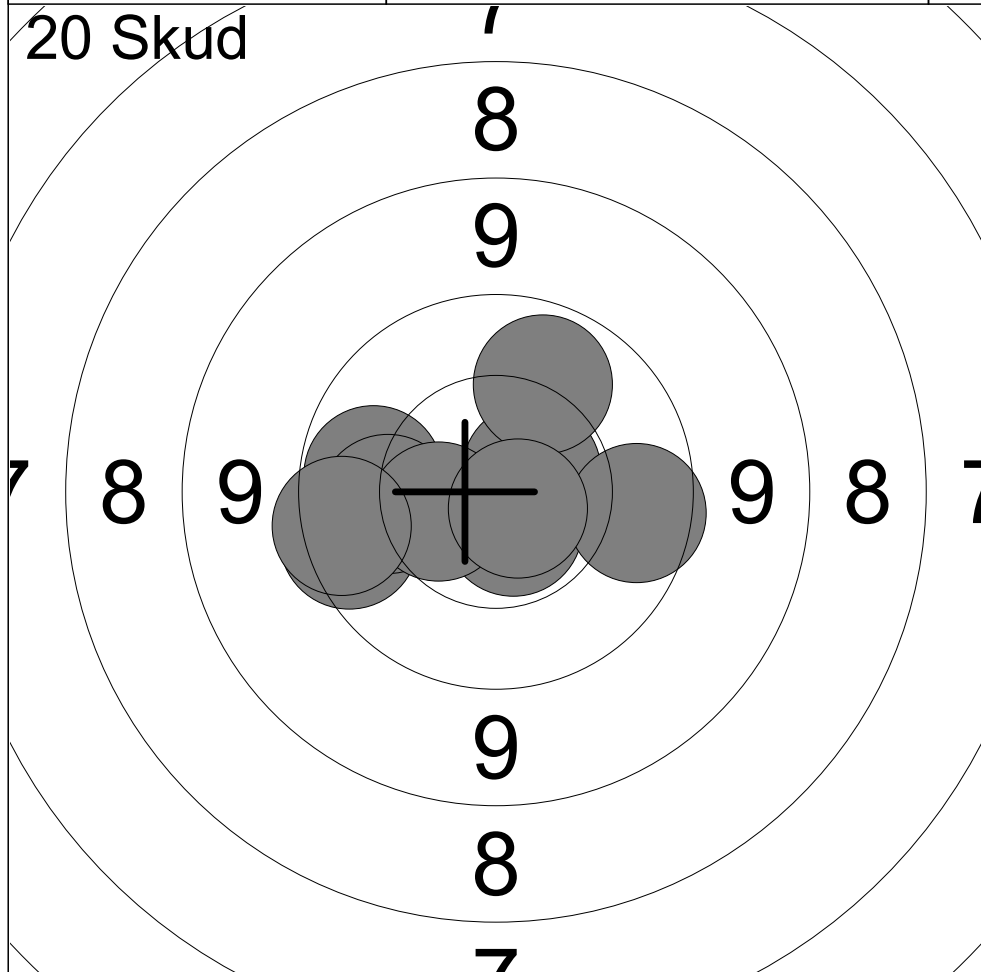

1:	10.0	←
2:	9.7	←
3:	10.1	←
4:	10.6x	↘
5:	10.6x	↗
6:	9.8	→
7:	10.5	←
8:	10.0	↗
9:	10.7x	↘
10:	9.7	←

Serie	97 (3x)
-------	----------

Total	97 (3x)
-------	----------

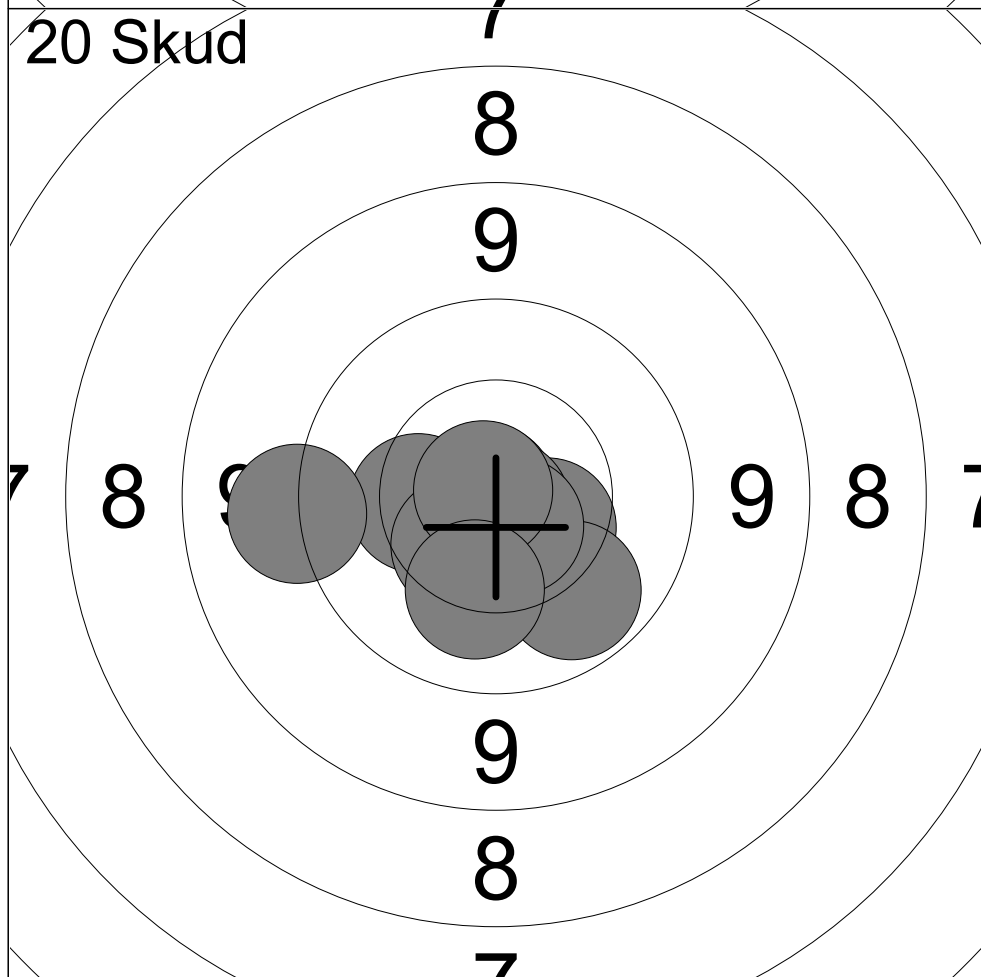

11:	10.3	←
12:	9.3	←
13:	10.5	↘
14:	10.5	↘
15:	10.9x	↗
16:	10.9x	↘
17:	10.0	↘
18:	10.7x	↘
19:	10.8x	↗
20:	10.2	↘

Serie	99 (4x)
-------	----------

Total	196 (7x)
-------	-----------

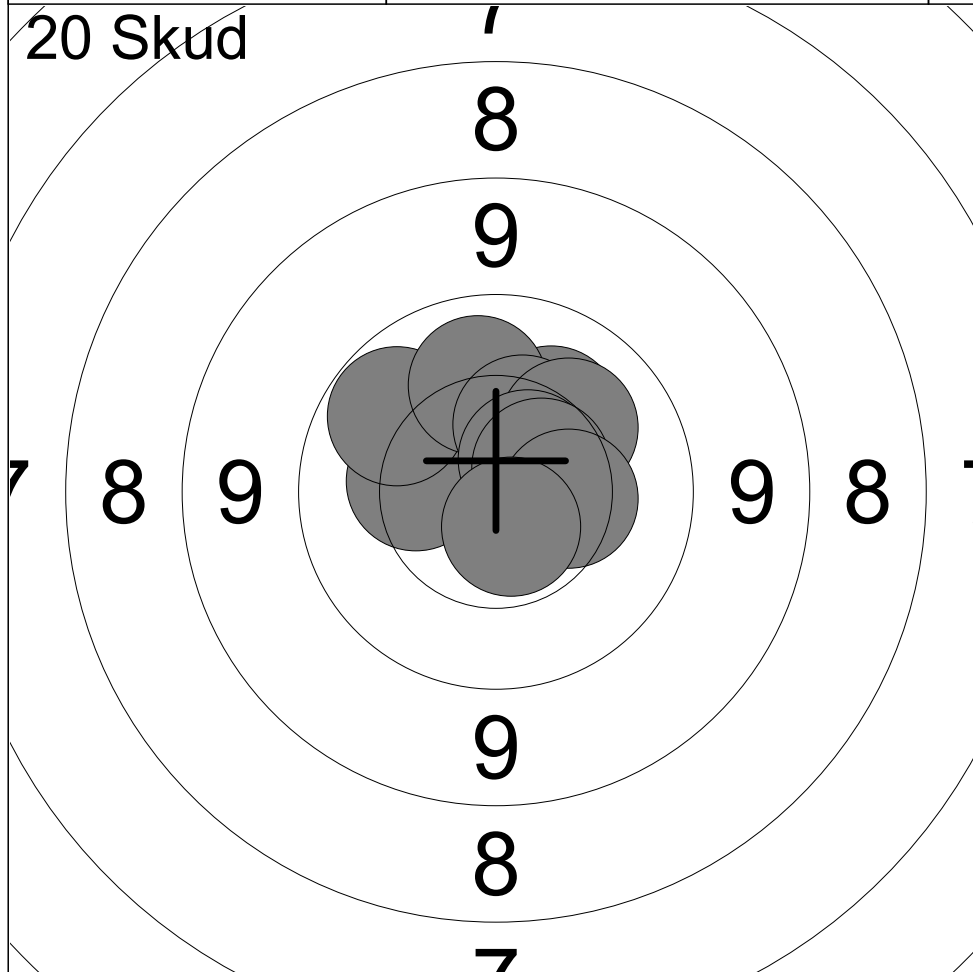

1:	10.2	↗
2:	10.3	←
3:	10.0	↖
4:	10.1	↑
5:	10.4	↗
6:	10.2	↗
7:	10.6x	↗
8:	10.5	↗
9:	10.4	→
10:	10.7x	↘

Serie	100 (2x)
Total	100 (2x)

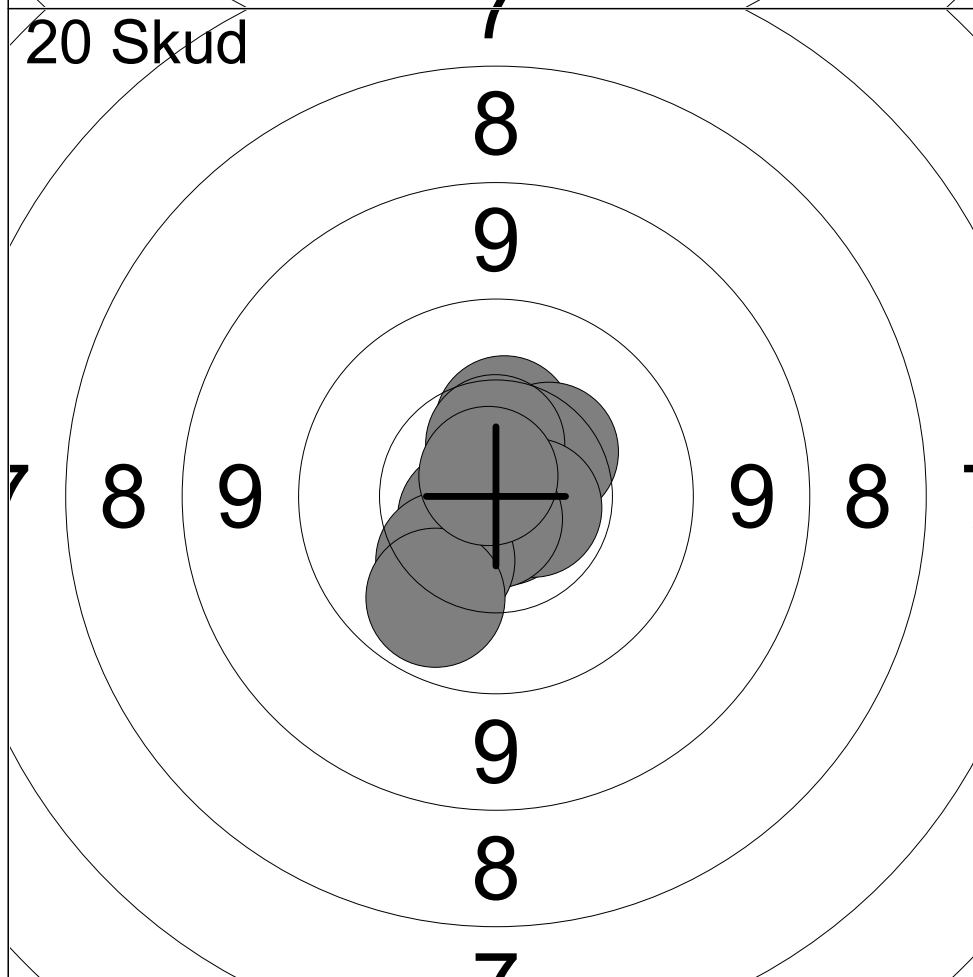

11:	10.4	↑
12:	10.4	↗
13:	10.5	↑
14:	10.8x	↘
15:	10.7x	→
16:	10.7x	↖
17:	10.8x	↘
18:	10.3	↖
19:	10.0	↖
20:	10.8x	↖

Serie	100 (5x)
Total	200 (7x)



1:	10.5	←
2:	10.8x	↗
3:	10.8x	↙
4:	10.5	↑
5:	10.1	→
6:	10.8x	↖
7:	10.8x	→
8:	10.6x	↓
9:	10.8x	→
10:	10.8x	↓

Serie	100 (7x)
Total	100 (7x)

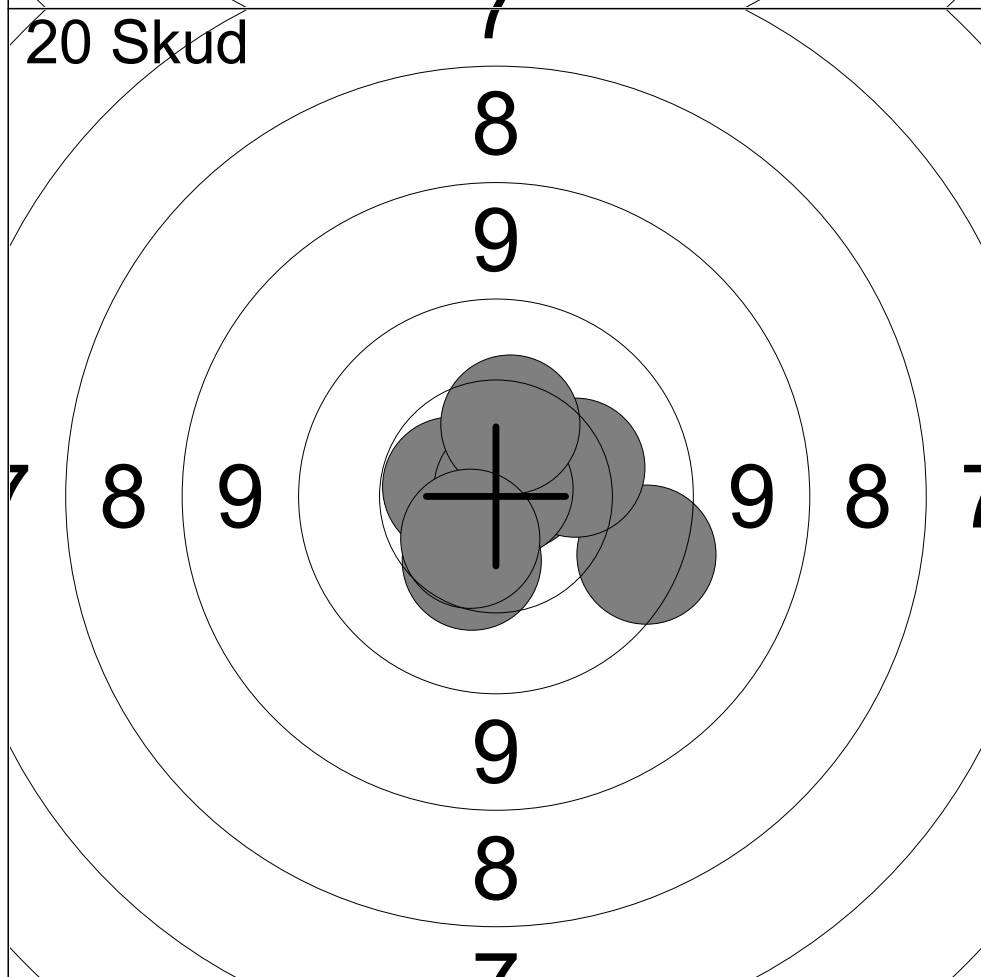

11:	10.8x	↗
12:	10.7x	←
13:	10.6x	←
14:	10.5	↑
15:	9.7	→
16:	10.3	→
17:	10.9x	↗
18:	10.4	↙
19:	10.4	↑
20:	10.6	↙

Serie	99 (4x)
Total	199 (11x)

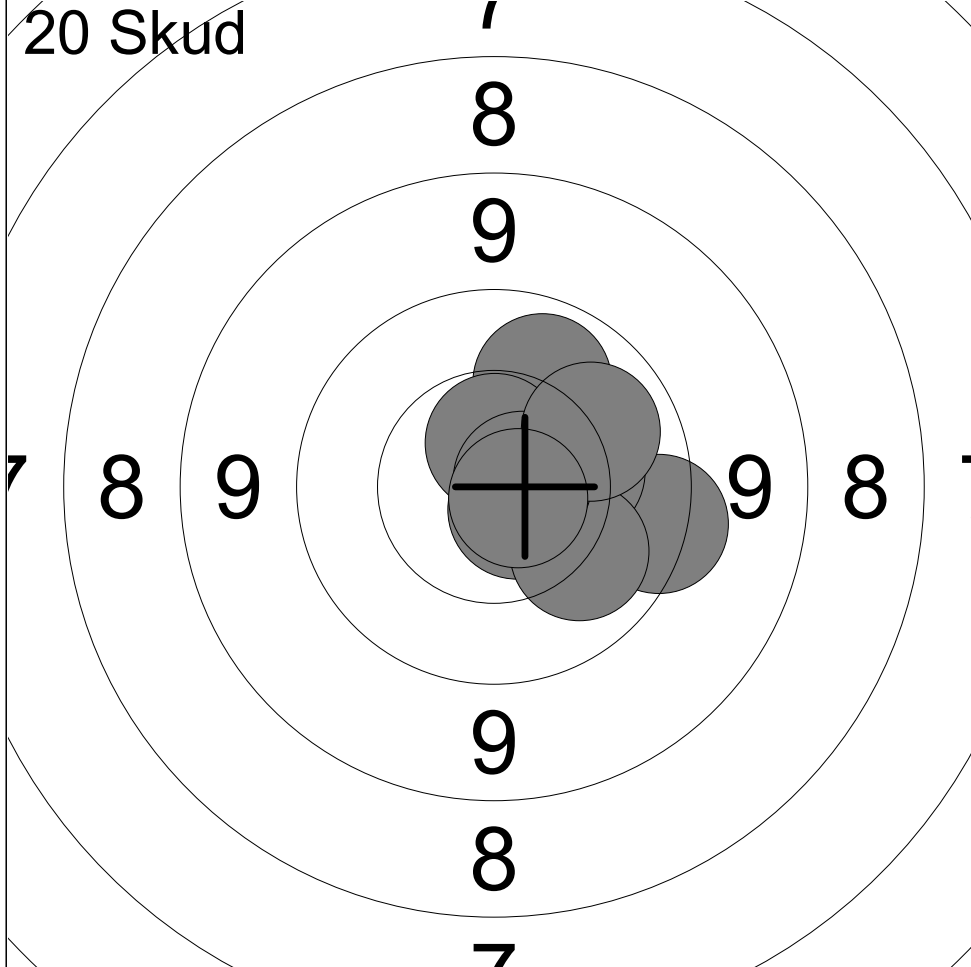

1:	10.1	↗
2:	10.7x	→
3:	10.6x	↑
4:	9.6	→
5:	10.7x	↘
6:	10.3	→
7:	10.1	↘
8:	10.7x	→
9:	10.1	↗
10:	10.7x	↘

Serie	99 (5x)
Total	99 (5x)

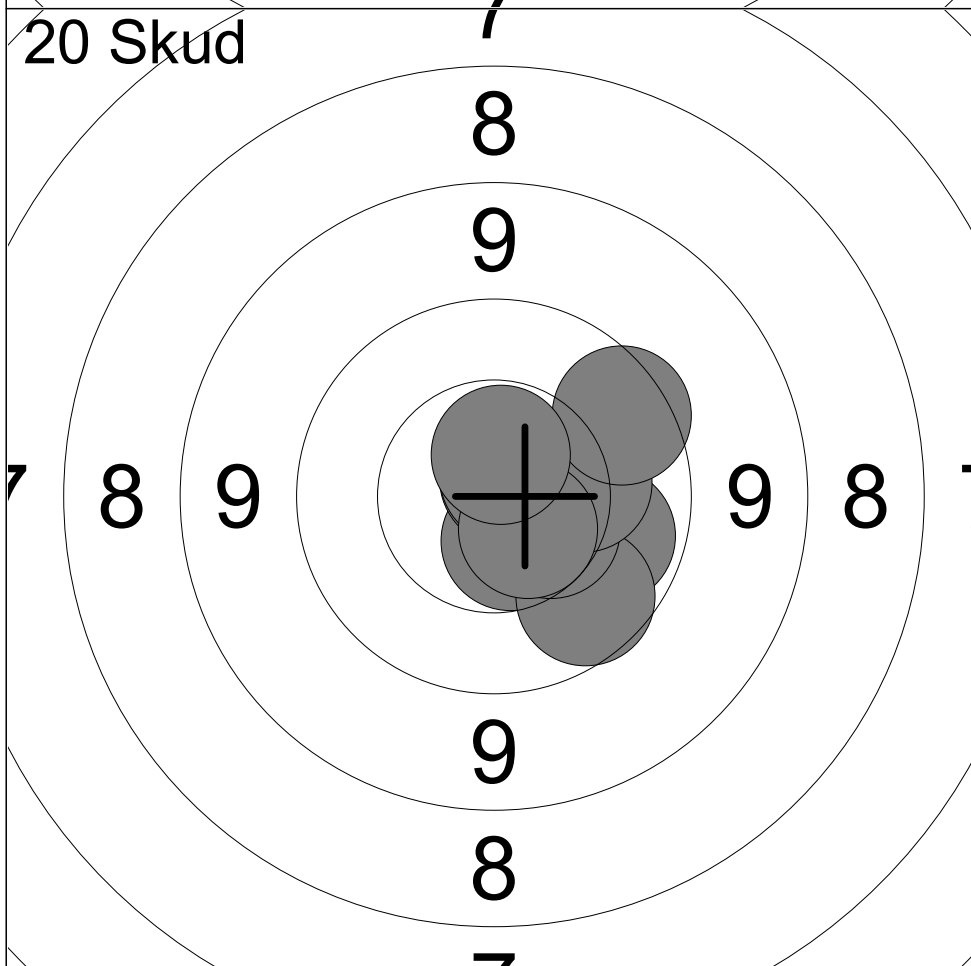

11:	10.6	↘
12:	10.0	→
13:	10.8x	↗
14:	9.9	↘
15:	10.4	↘
16:	10.7x	↗
17:	10.2	→
18:	9.7	↗
19:	10.6	↘
20:	10.6x	↑

Serie	98 (3x)
Total	197 (8x)

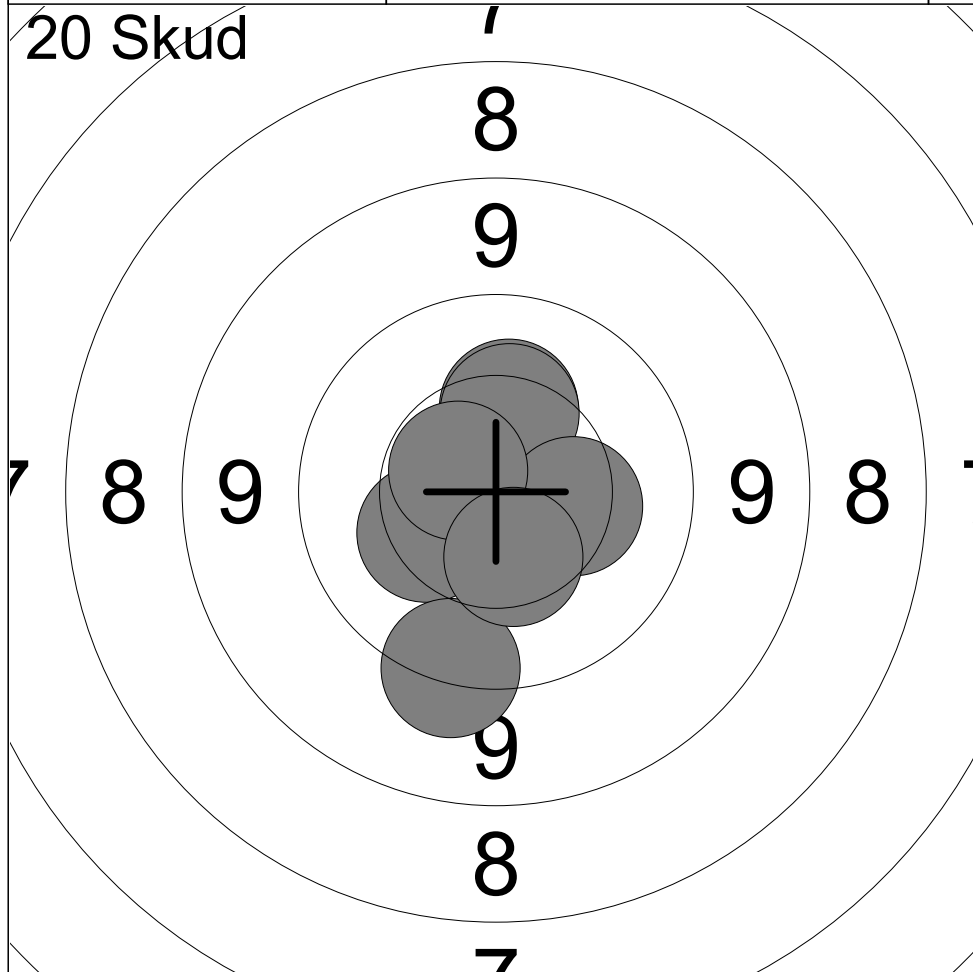

1:	10.7x	→
2:	10.3	↑
3:	10.3	↑
4:	10.6x	←
5:	10.3	↙
6:	10.6	↘
7:	10.3	→
8:	10.6x	↖
9:	9.5	↘
10:	10.4	↘

Serie	99 (3x)
-------	----------

Total	99 (3x)
-------	----------

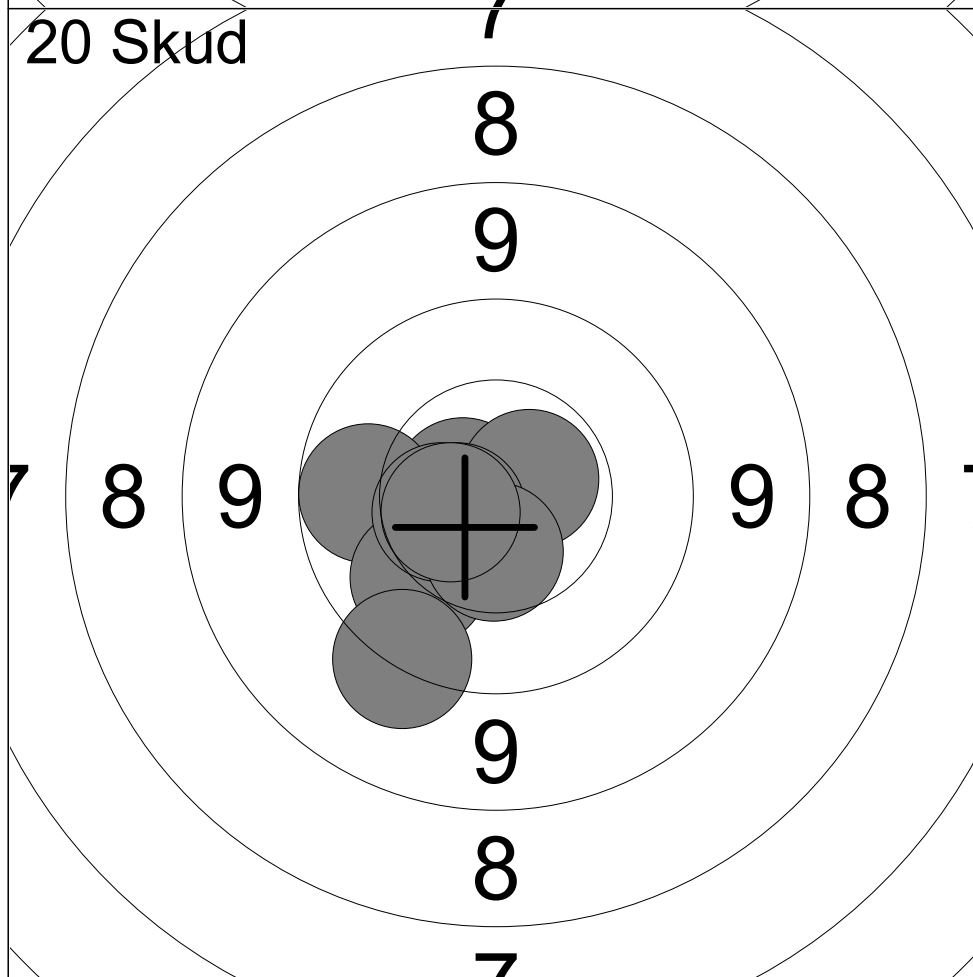

11:	10.7x	←
12:	10.7x	↗
13:	9.9	←
14:	10.5	↘
15:	10.1	↙
16:	10.5	←
17:	10.6x	←
18:	10.5	↘
19:	9.4	↘
20:	10.6	←

Serie	98 (3x)
-------	----------

Total	197 (6x)
-------	-----------

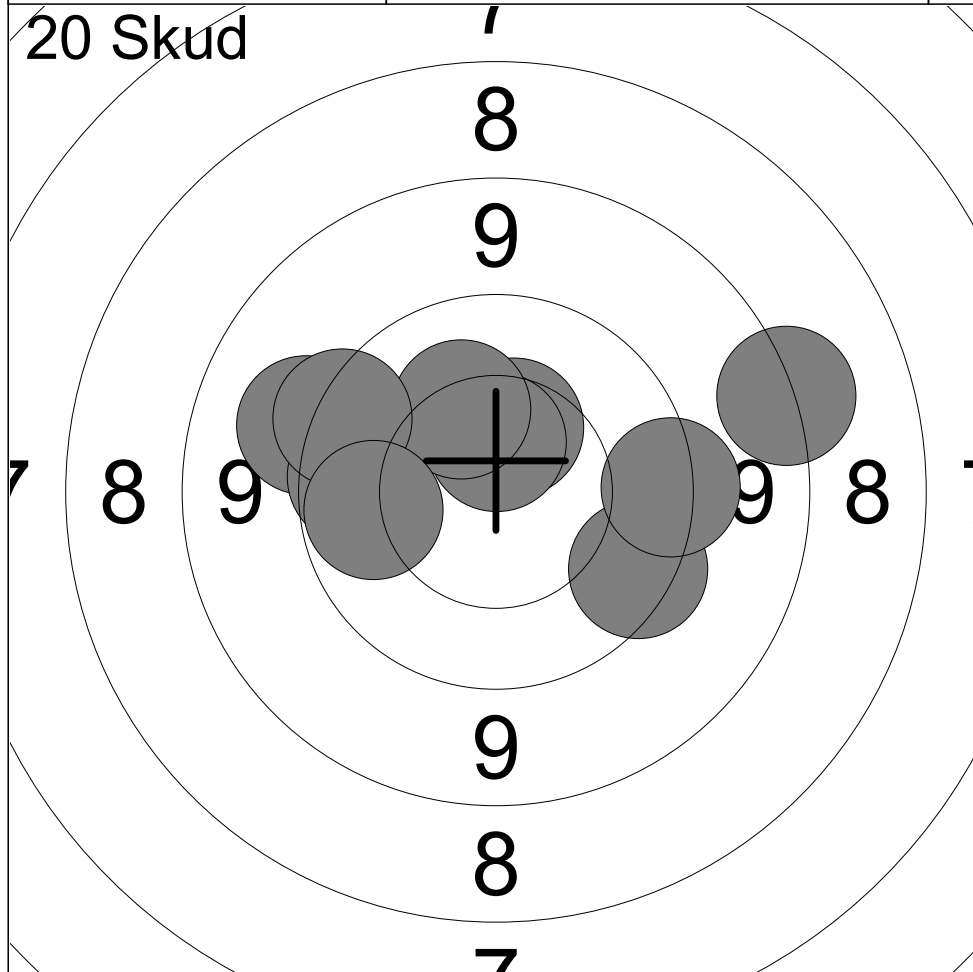

1:	8.4	→
2:	9.7	↘
3:	9.5	→
4:	10.4	↑
5:	9.3	↖
6:	9.8	←
7:	10.6	↑
8:	10.3	↗
9:	9.6	↖
10:	10.0	←

Serie	93 (0x)
Total	93 (0x)

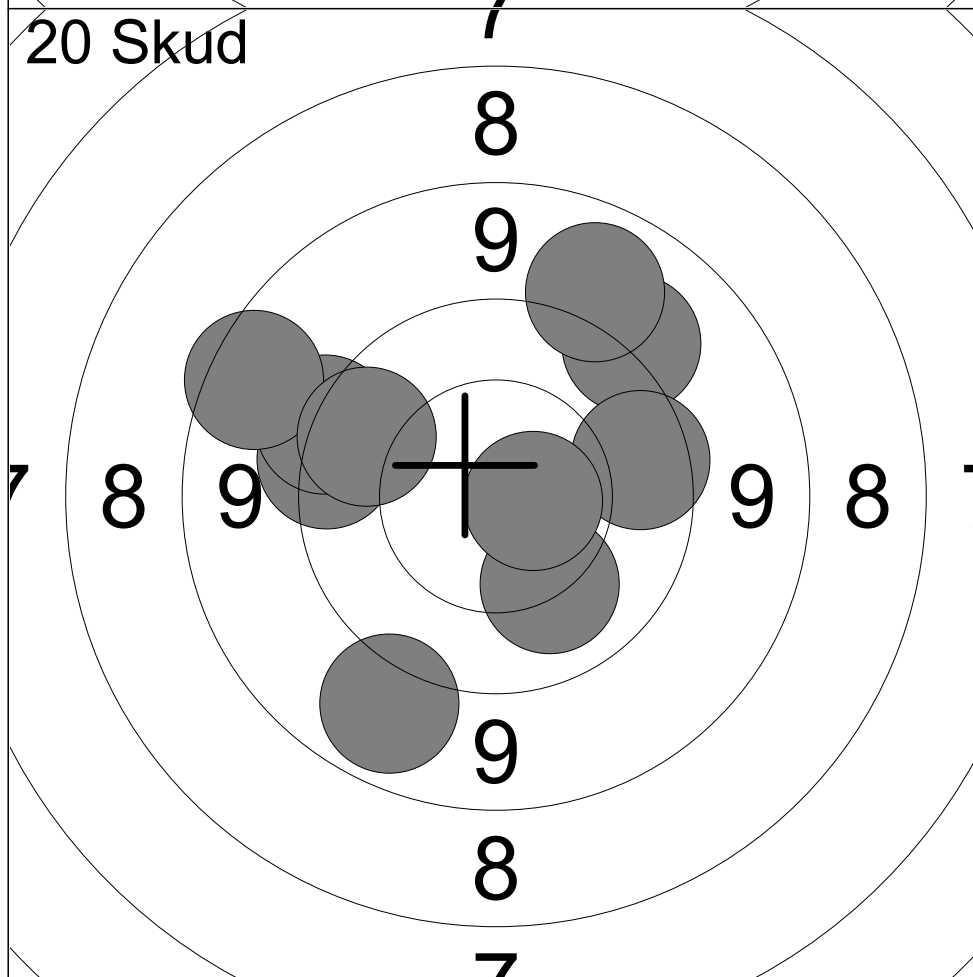

11:	9.0	↘
12:	9.6	←
13:	9.3	↗
14:	10.1	↘
15:	9.1	↗
16:	9.8	→
17:	9.5	↖
18:	10.7x	→
19:	8.7	↖
20:	9.8	↖

Serie	91 (1x)
Total	184 (1x)

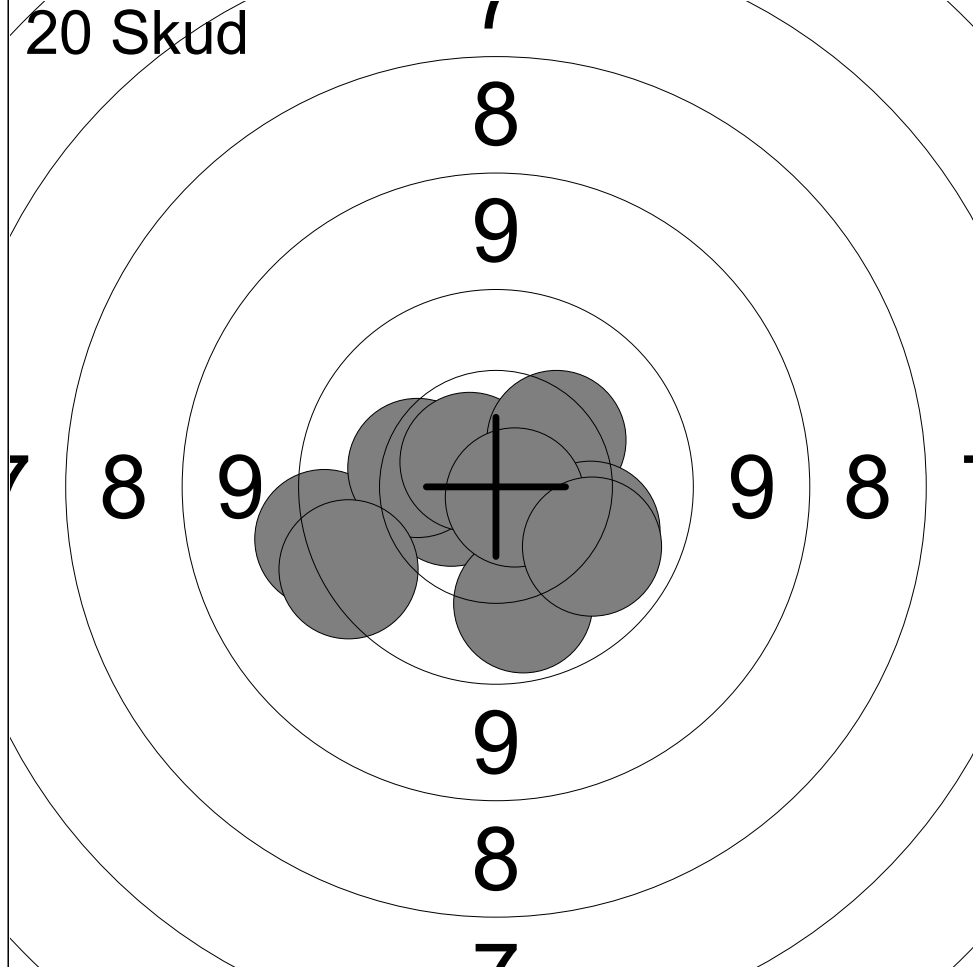

1:	10.6x	←
2:	9.5	←
3:	10.3	←
4:	9.6	←
5:	10.7x	↗
6:	10.3	↗
7:	10.0	↓
8:	10.1	↘
9:	10.8x	↘
10:	10.1	↘

Serie	98 (3x)
Total	98 (3x)

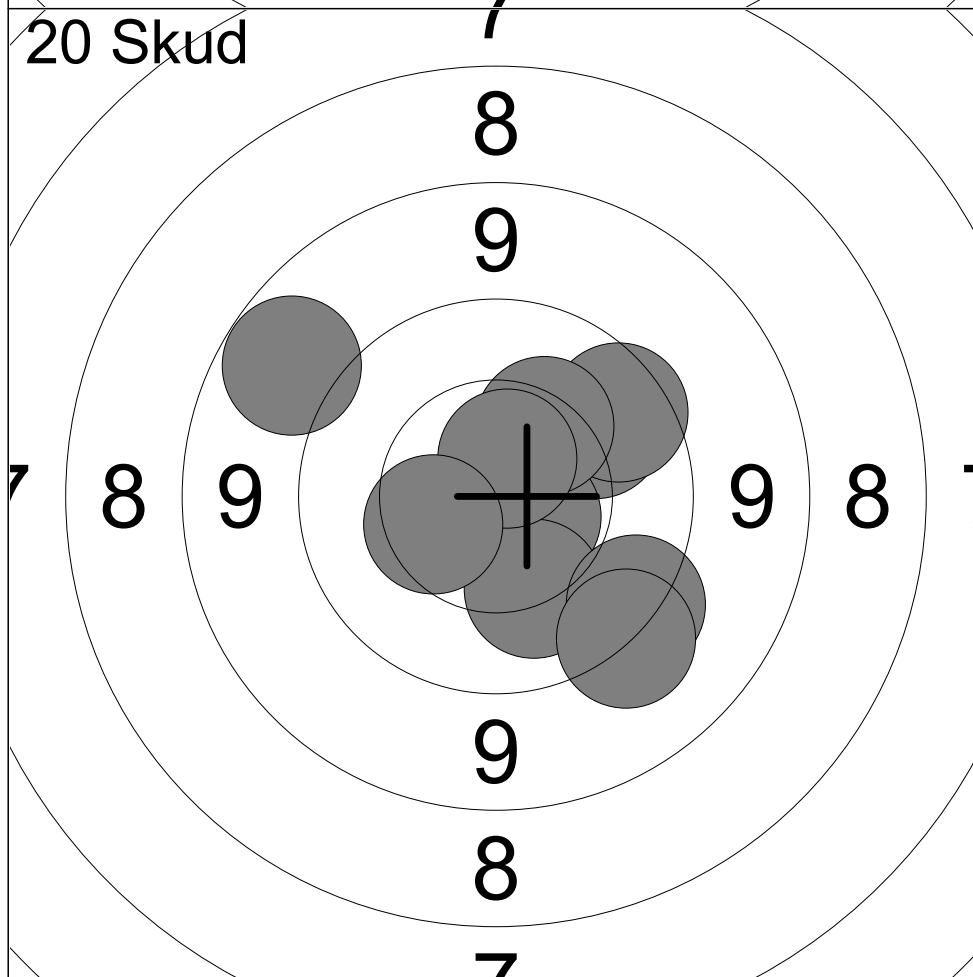

11:	9.0	↖
12:	10.0	↗
13:	10.6x	↘
14:	10.2	↓
15:	9.8	↗
16:	9.5	↘
17:	9.4	↘
18:	10.3	↗
19:	10.6x	↗
20:	10.4	←

Serie	96 (2x)
Total	194 (5x)

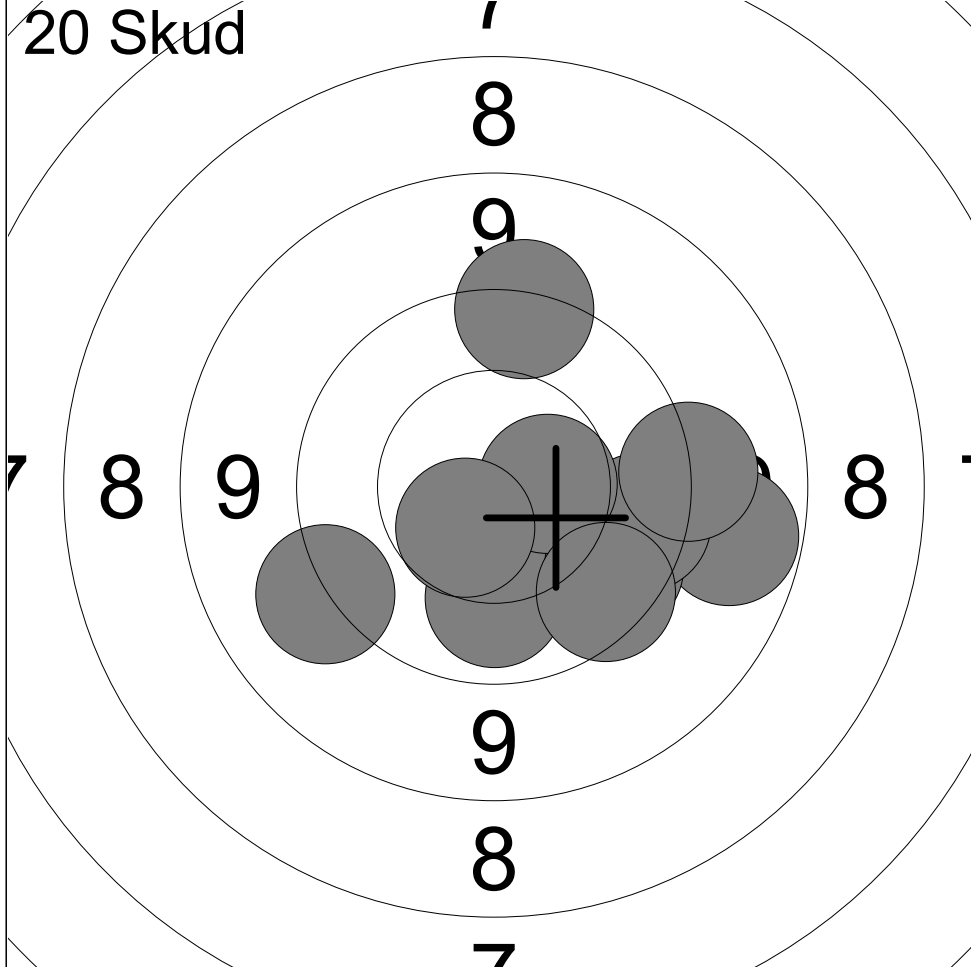

1:	9.5	↑
2:	10.1	↓
3:	9.0	→
4:	9.8	↘
5:	9.7	→
6:	10.5	→
7:	9.4	→
8:	9.7	↘
9:	9.3	↙
10:	10.6	↙

Serie	93 (0x)
Total	93 (0x)

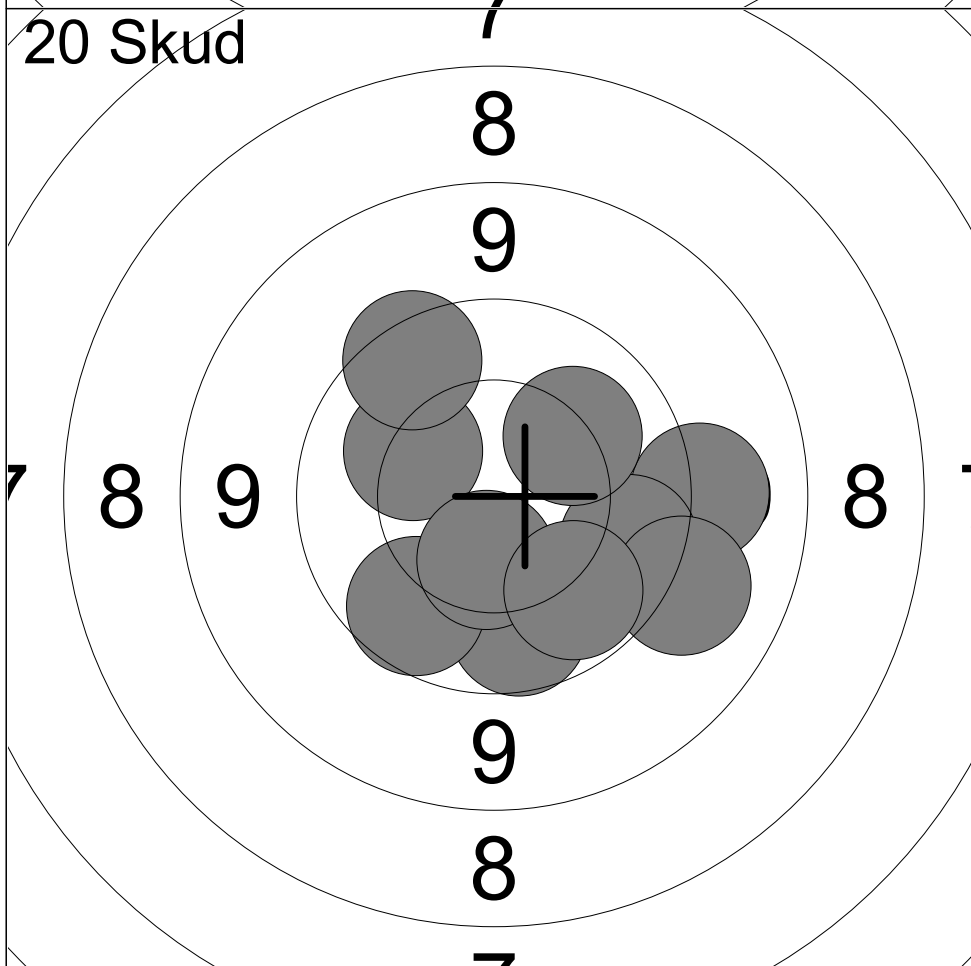

11:	9.3	→
12:	9.8	↘
13:	10.2	↗
14:	9.9	↓
15:	9.3	↘
16:	9.9	↙
17:	10.2	↗
18:	10.4	↓
19:	10.0	↘
20:	9.7	↗

Serie	94 (0x)
Total	187 (0x)

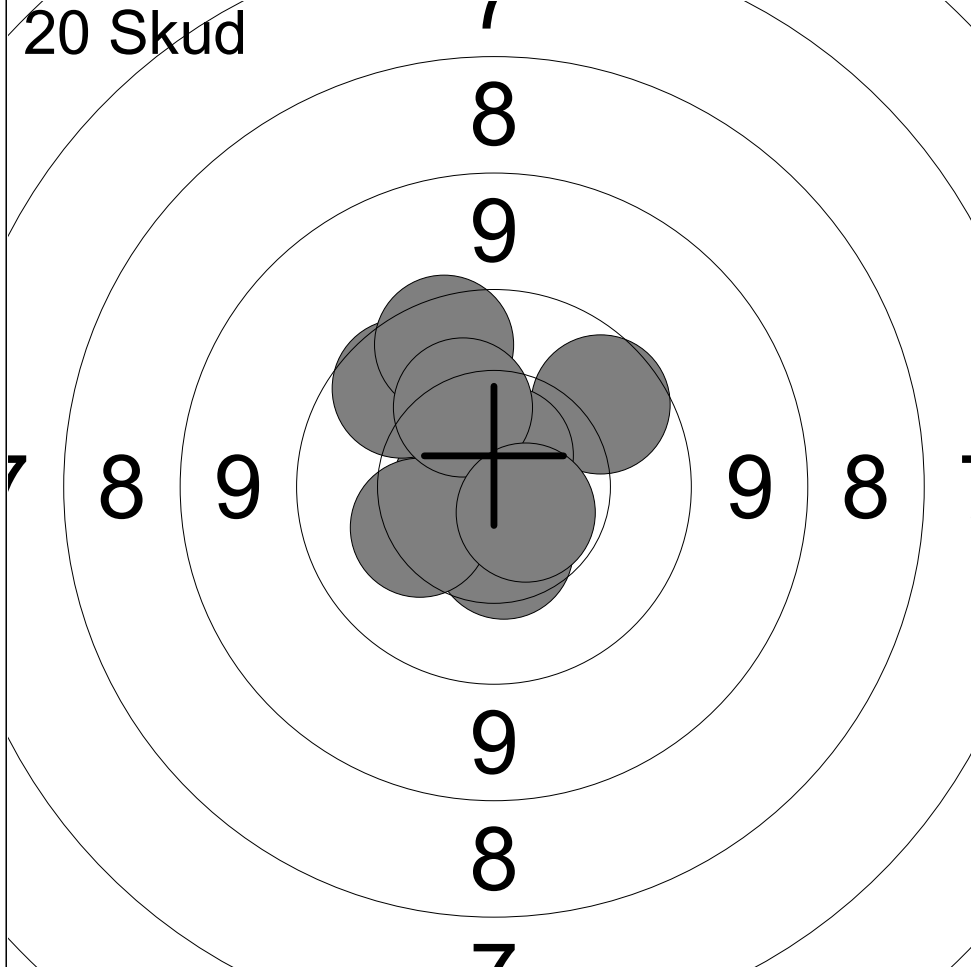

1:	9.9	↗
2:	10.7x	↑
3:	10.7x	←
4:	10.5	↓
5:	9.9	↘
6:	10.7x	↗
7:	10.3	↙
8:	9.8	↑
9:	10.3	↗
10:	10.6x	↘

Serie	97 (4x)
Total	97 (4x)

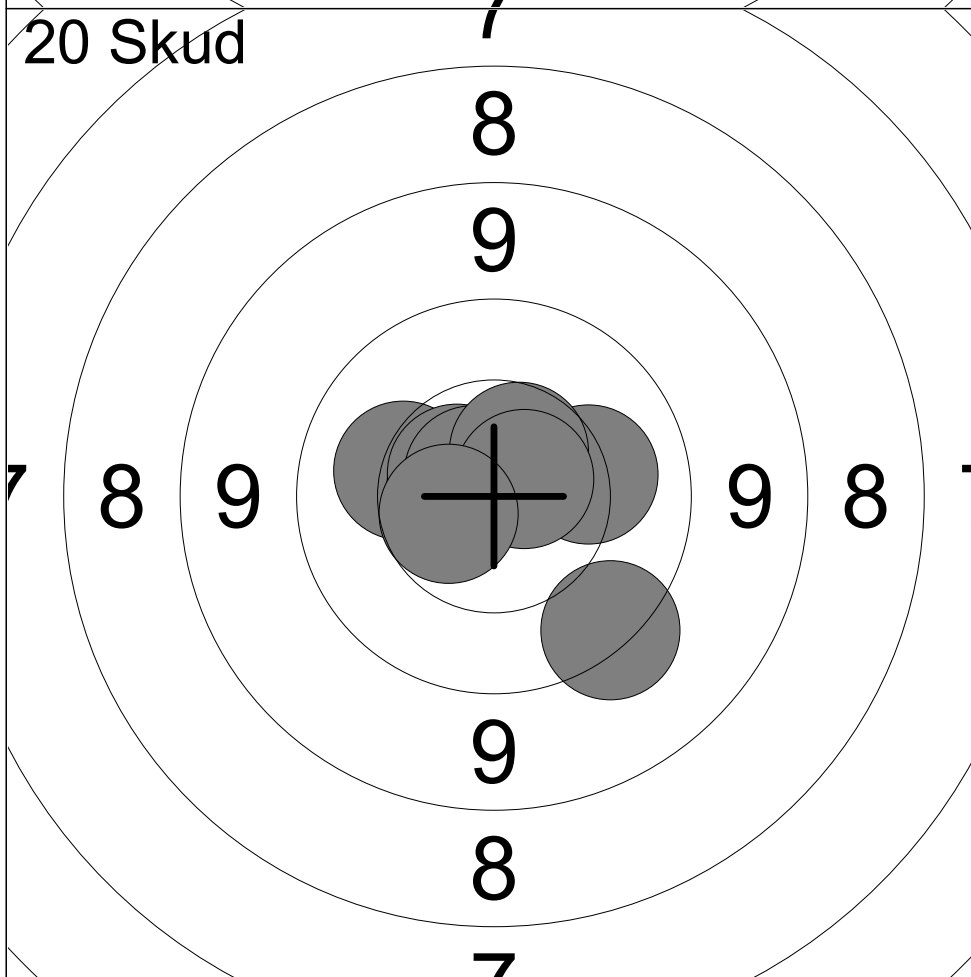

11:	10.2	↙
12:	10.2	→
13:	10.6x	↗
14:	10.6x	←
15:	10.6x	↗
16:	10.7x	↗
17:	10.5	↗
18:	9.5	↘
19:	10.7x	↗
20:	10.6	↙

Serie	99 (5x)
Total	196 (9x)

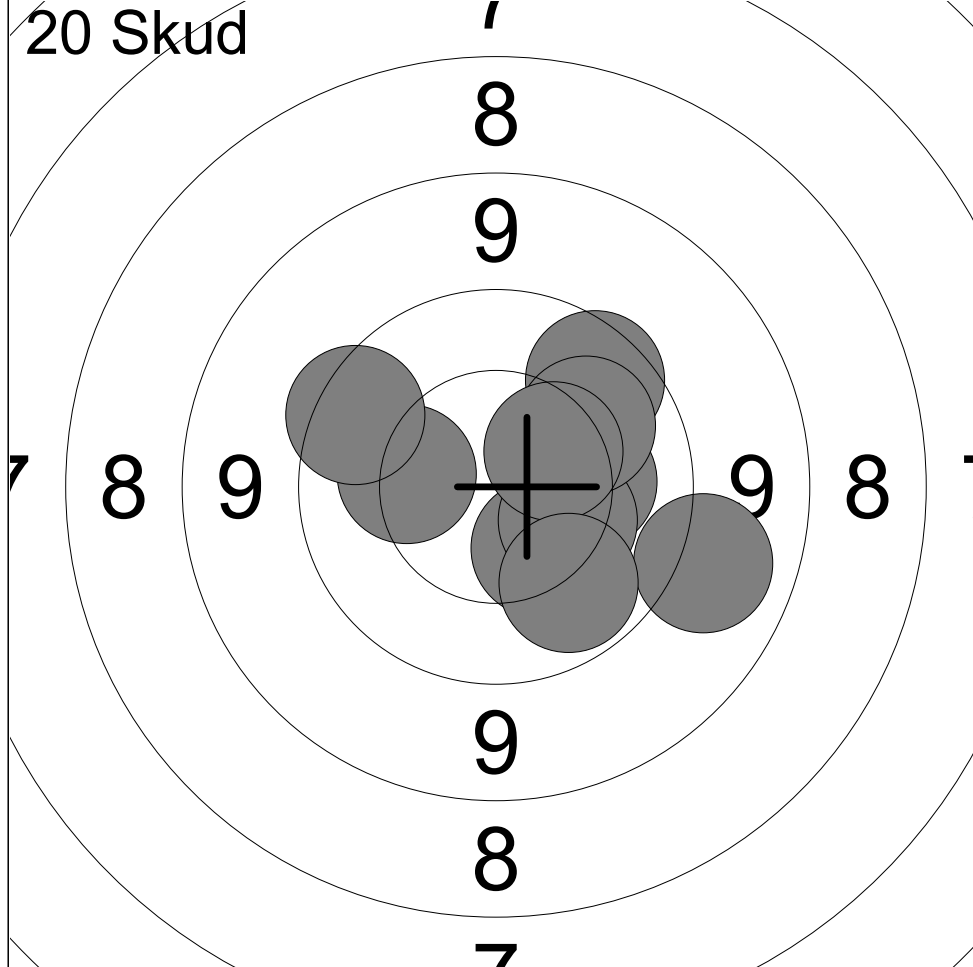

1:	10.4	↘
2:	10.2	→
3:	10.3	↘
4:	10.2	←
5:	9.1	↘
6:	9.8	↗
7:	9.7	↖
8:	10.1	↗
9:	10.4	↗
10:	10.0	↘

Serie	97 (0x)
Total	97 (0x)

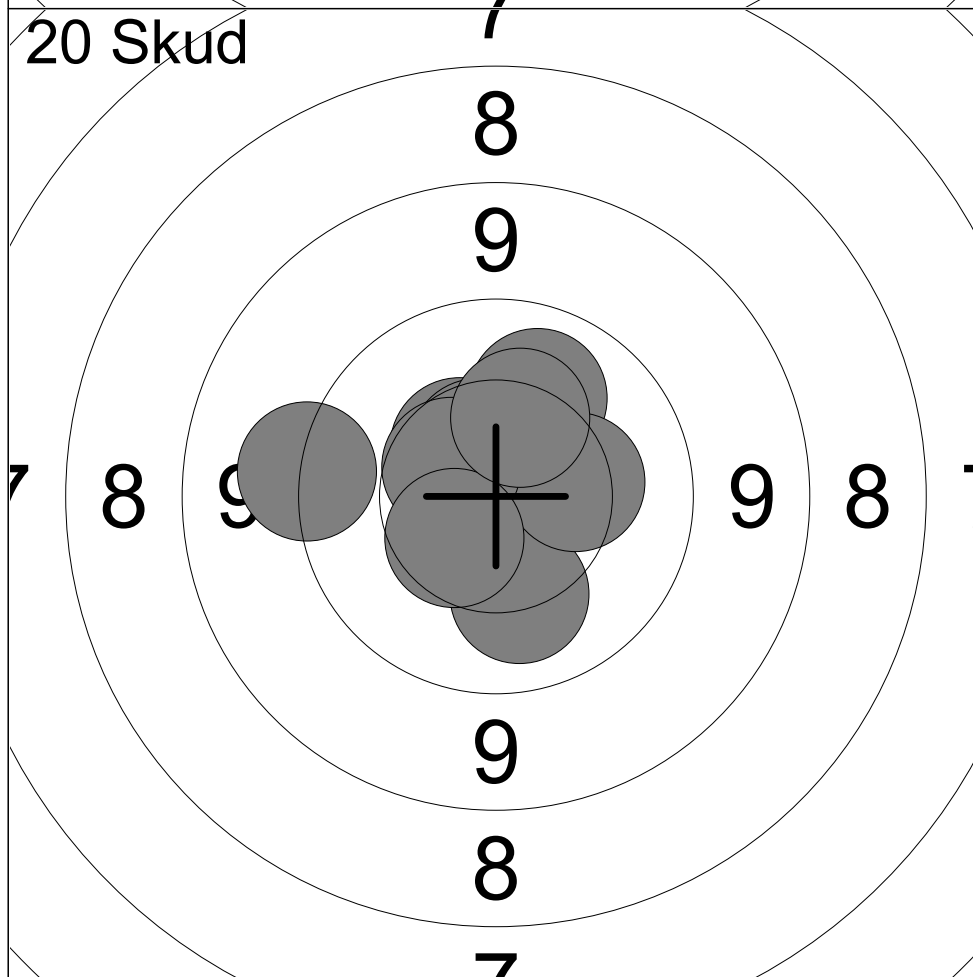

11:	10.7x	←
12:	10.5	↗
13:	10.2	↘
14:	10.5	↗
15:	9.4	←
16:	10.1	↗
17:	10.3	→
18:	10.5	↗
19:	10.5	↖
20:	10.3	↗

Serie	99 (1x)
Total	196 (1x)

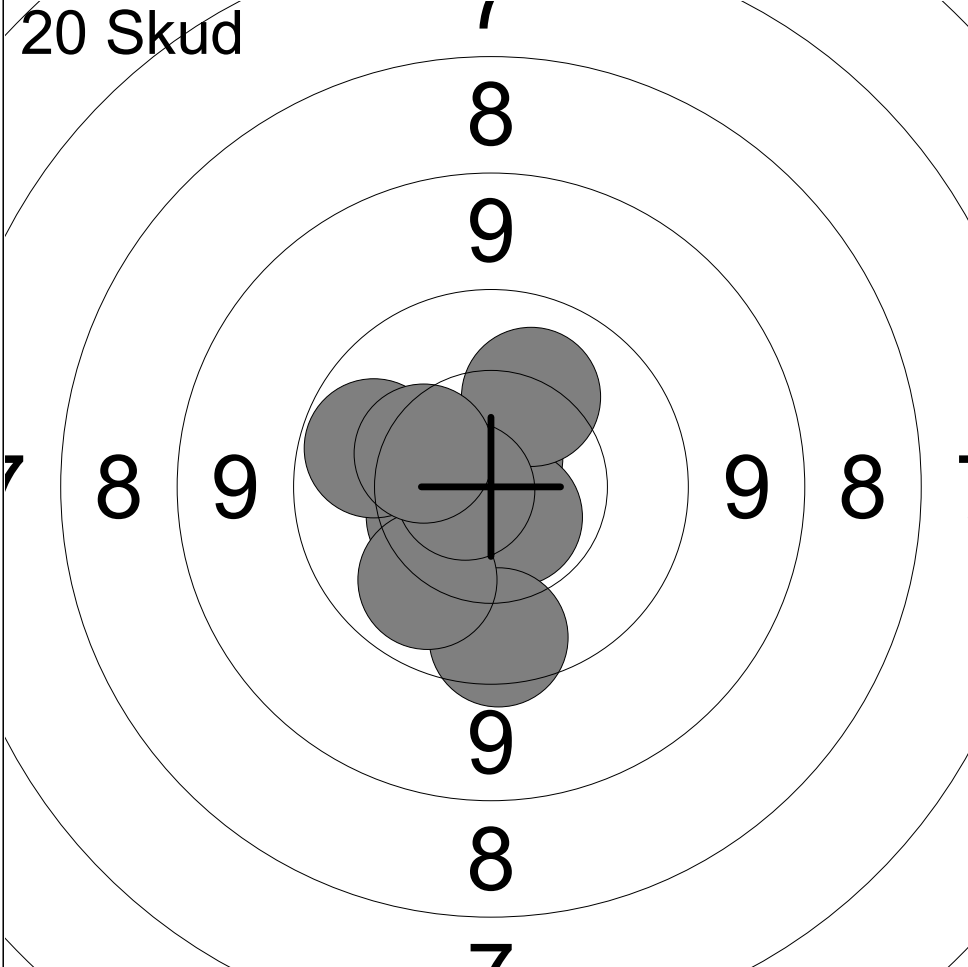

1:	10.7x	↑
2:	10.8x	↓
3:	10.7x	↘
4:	10.5	↙
5:	9.8	↓
6:	10.1	↙
7:	10.2	↗
8:	10.7x	←
9:	10.0	↙
10:	10.4	↙

Serie	99 (4x)
Total	99 (4x)

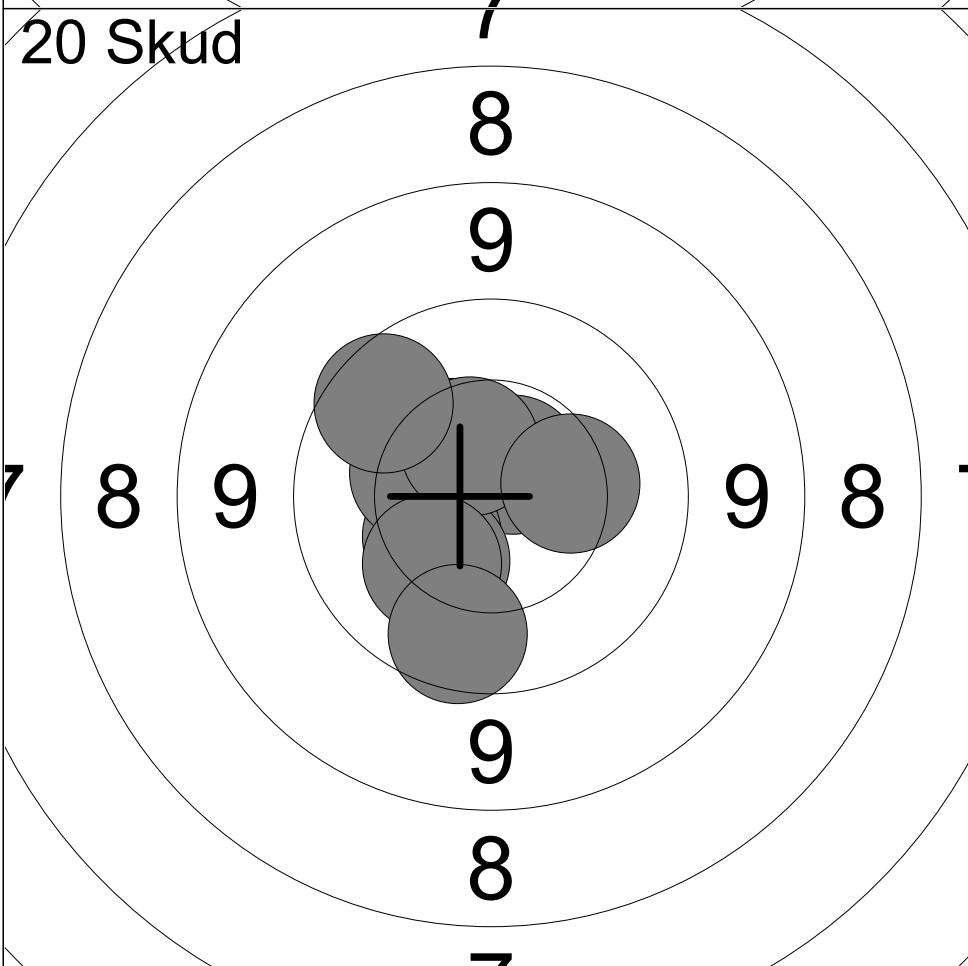

11:	10.5	↖
12:	10.6x	↗
13:	10.4	↙
14:	10.3	↙
15:	10.4	↙
16:	10.5	↗
17:	9.8	↗
18:	10.3	→
19:	10.2	↙
20:	9.8	↓

Serie	98 (1x)
Total	197 (5x)

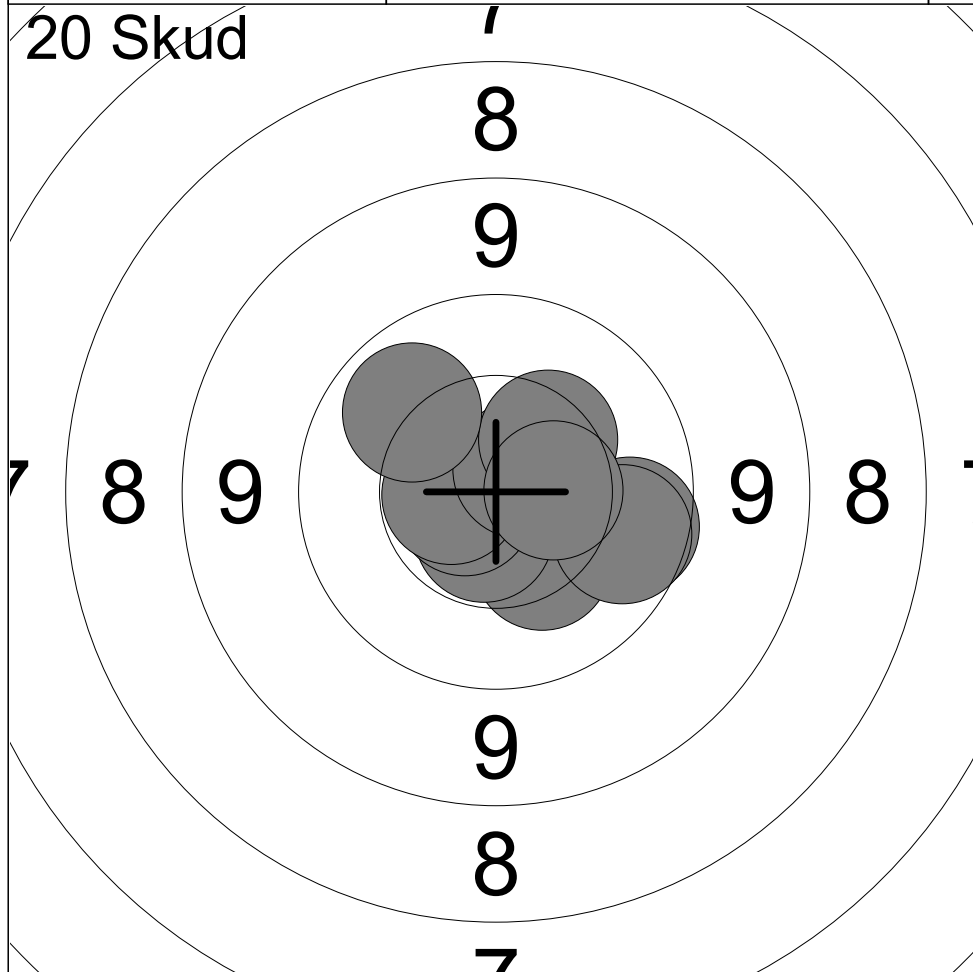

1:	10.3	↘
2:	10.6x	↘
3:	10.7x	↙
4:	9.9	→
5:	10.6x	←
6:	10.7x	↗
7:	9.9	→
8:	10.4	↗
9:	10.0	↗
10:	10.5	→

Serie	98 (4x)
Total	98 (4x)

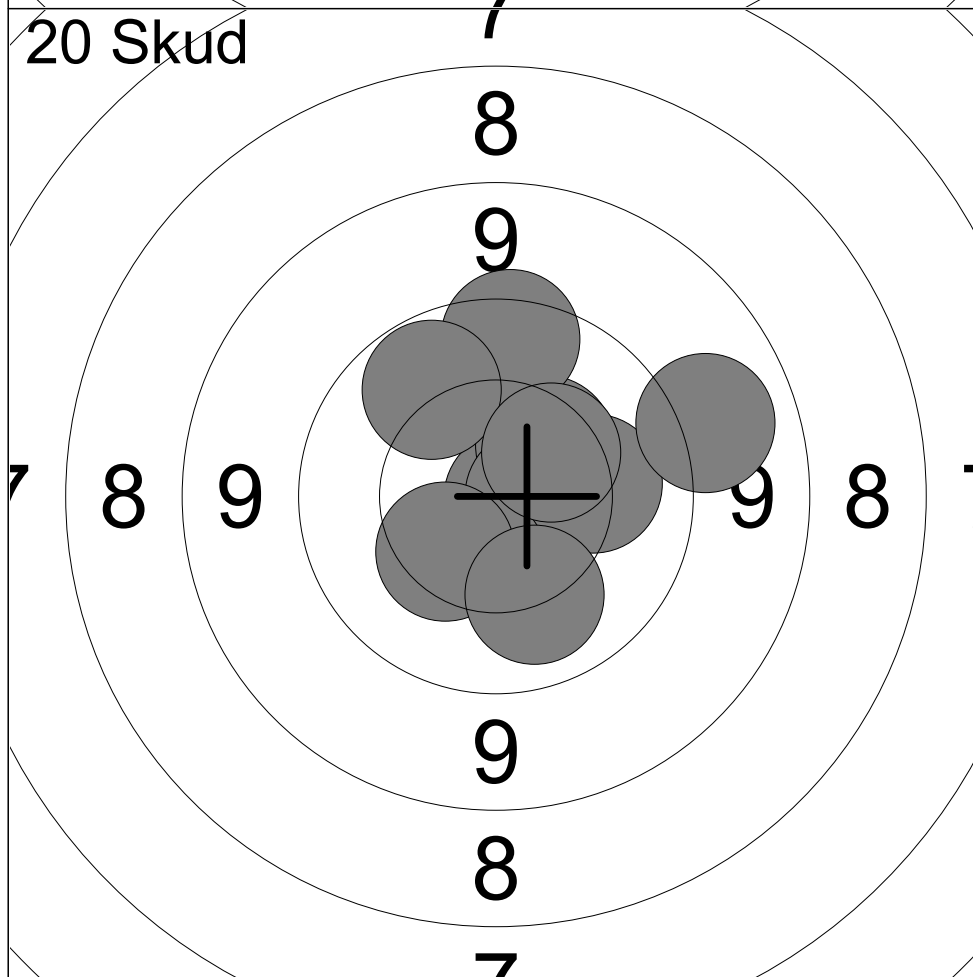

11:	10.8x	→
12:	10.4	↗
13:	10.6x	→
14:	10.4	↙
15:	9.7	↑
16:	10.0	↖
17:	10.2	→
18:	9.1	↗
19:	10.1	↘
20:	10.4	↗

Serie	98 (2x)
Total	196 (6x)

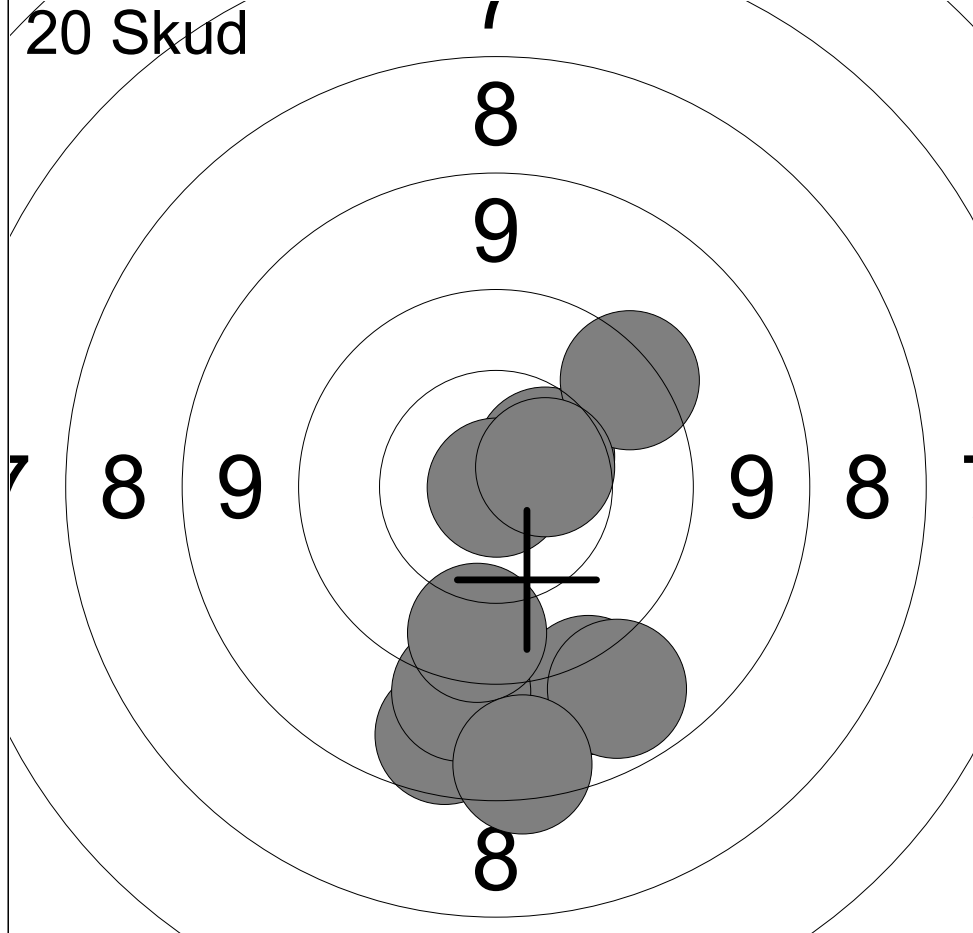

1:	10.5	↗
2:	8.9	↓
3:	9.2	↘
4:	9.6	↗
5:	9.3	↓
6:	9.8	↓
7:	9.0	↘
8:	8.7	↓
9:	10.9x	↘
10:	10.5	↗

Serie	91 (1x)
Total	91 (1x)

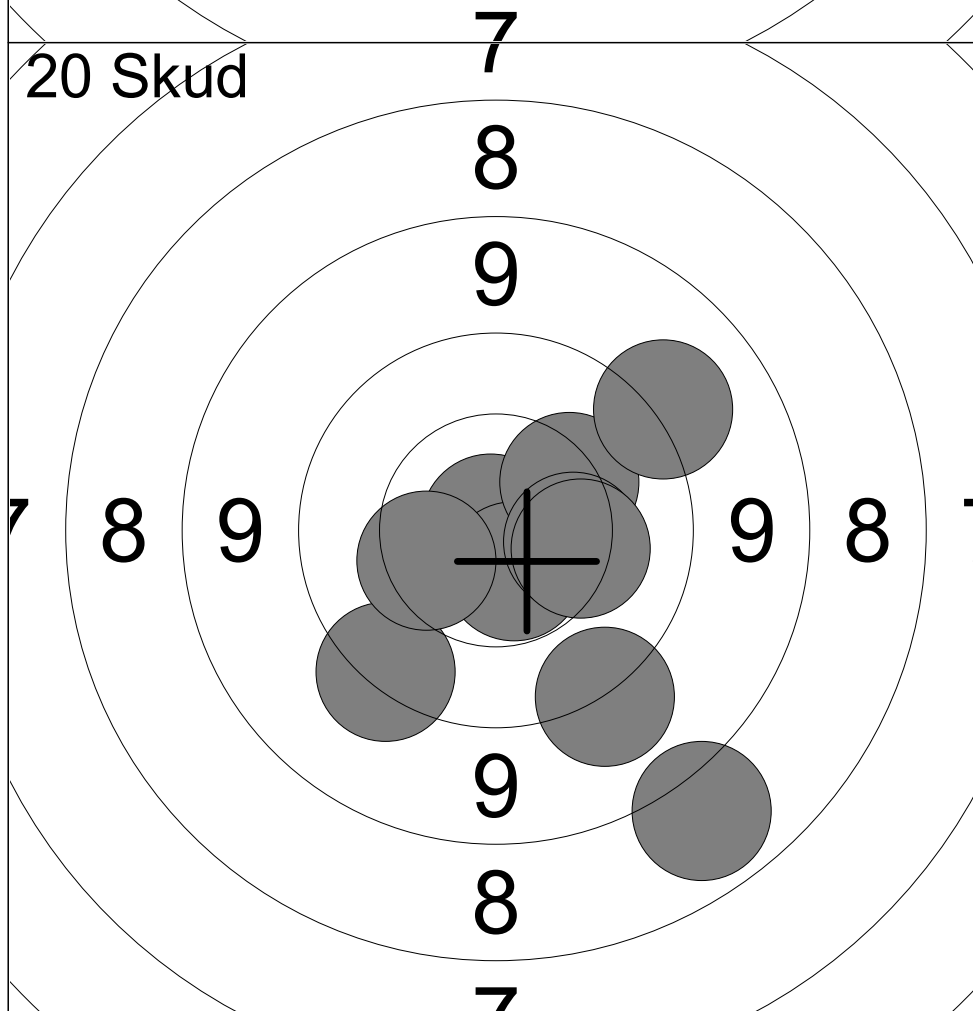

11:	9.5	↙
12:	10.9x	↗
13:	10.6x	↘
14:	9.3	↘
15:	10.3	↗
16:	10.3	→
17:	10.3	→
18:	10.4	↙
19:	9.3	↗
20:	8.1	↘

Serie	95 (2x)
Total	186 (3x)

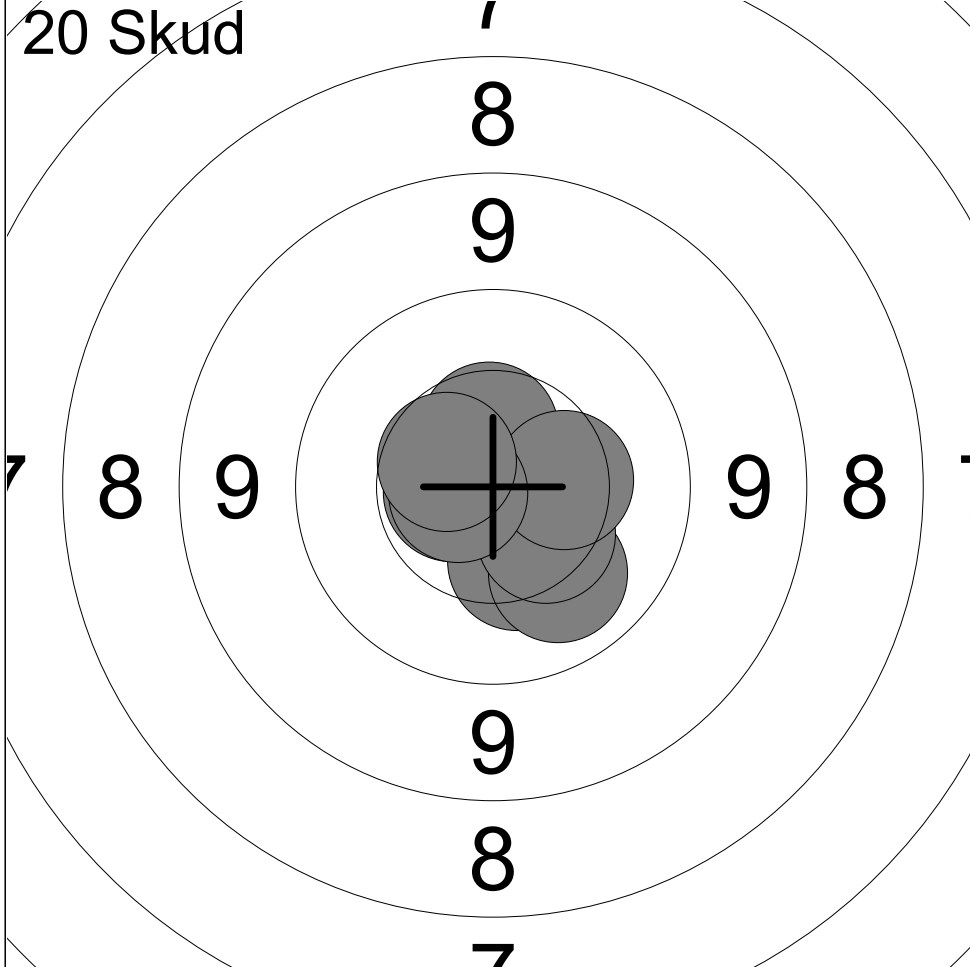

1:	10.6x	←
2:	10.3	↓
3:	10.7x	↑
4:	10.1	↘
5:	10.7x	↘
6:	10.5	↑
7:	10.4	↘
8:	10.4	→
9:	10.7x	←
10:	10.5	↖

Serie	100 (4x)
Total	100 (4x)

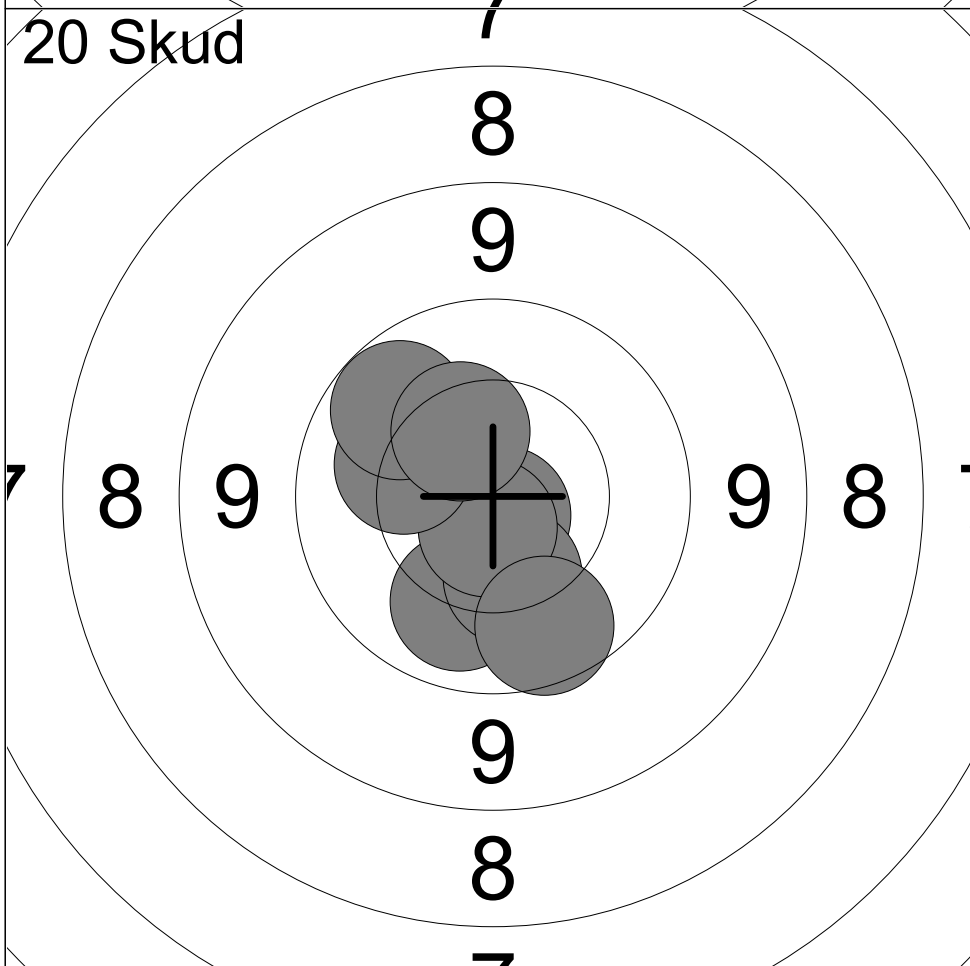

11:	10.4	↖
12:	10.1	↓
13:	10.8x	↘
14:	10.1	↘
15:	10.3	↘
16:	10.7x	↘
17:	10.2	↖
18:	10.0	↖
19:	9.9	↘
20:	10.4	↖

Serie	99 (2x)
Total	199 (6x)

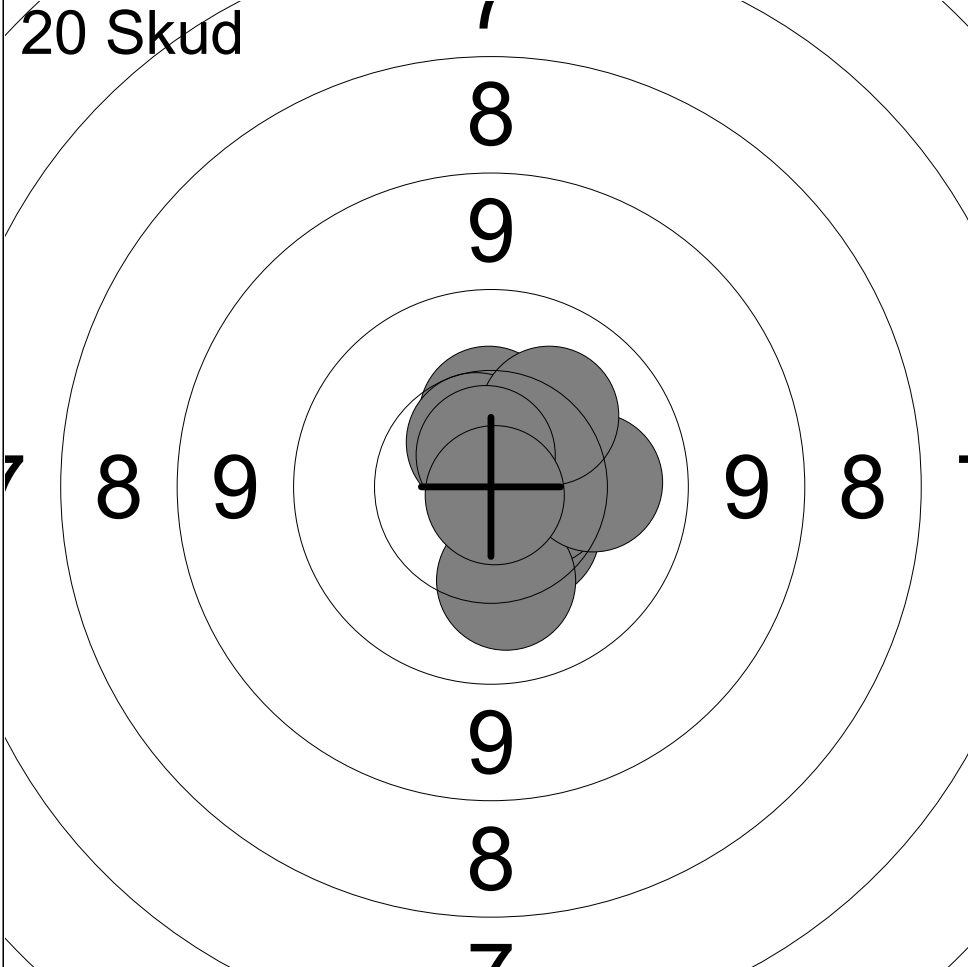

1:	10.5	↘
2:	10.4	↑
3:	10.5	→
4:	10.6	→
5:	10.2	↘
6:	10.2	→
7:	10.6	↑
8:	10.2	↗
9:	10.7x	↑
10:	10.9x	↘

Serie	100 (2x)
Total	100 (2x)

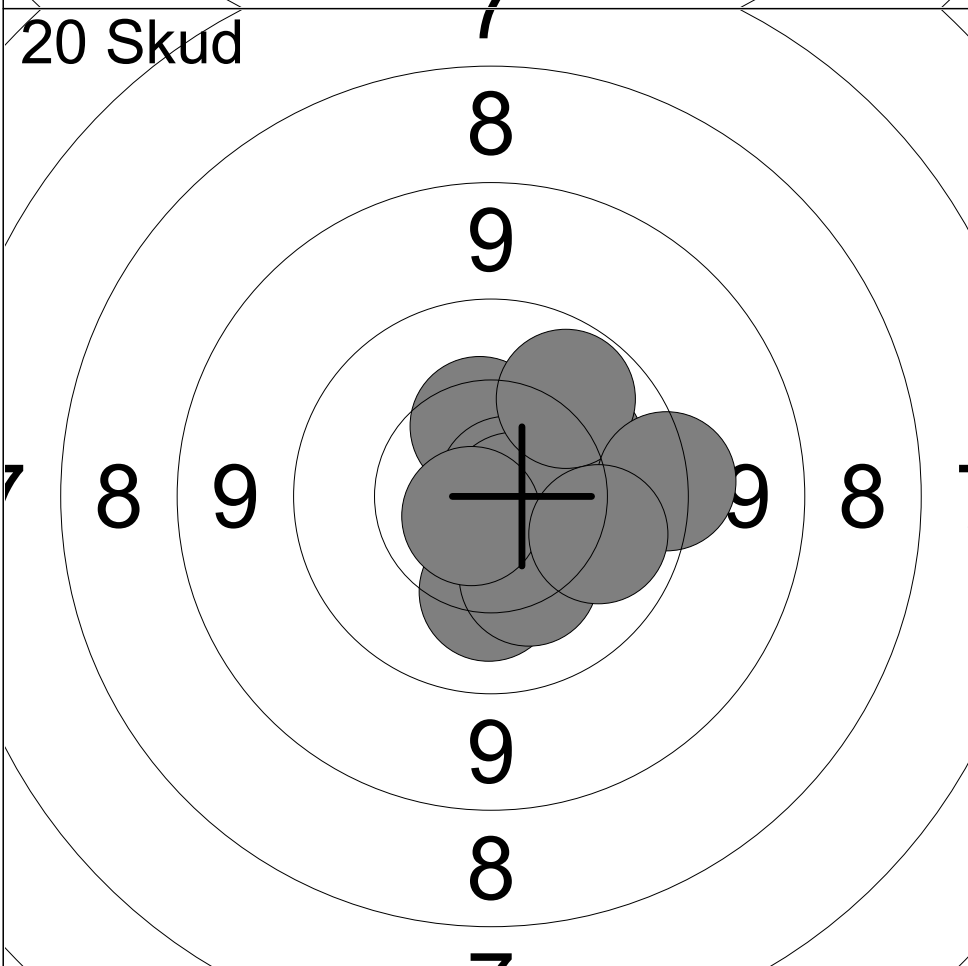

11:	10.4	↑
12:	10.8x	↗
13:	10.2	↗
14:	10.2	↘
15:	10.8x	→
16:	10.3	↘
17:	10.7x	↙
18:	10.0	↗
19:	9.5	→
20:	10.1	→

Serie	99 (3x)
Total	199 (5x)

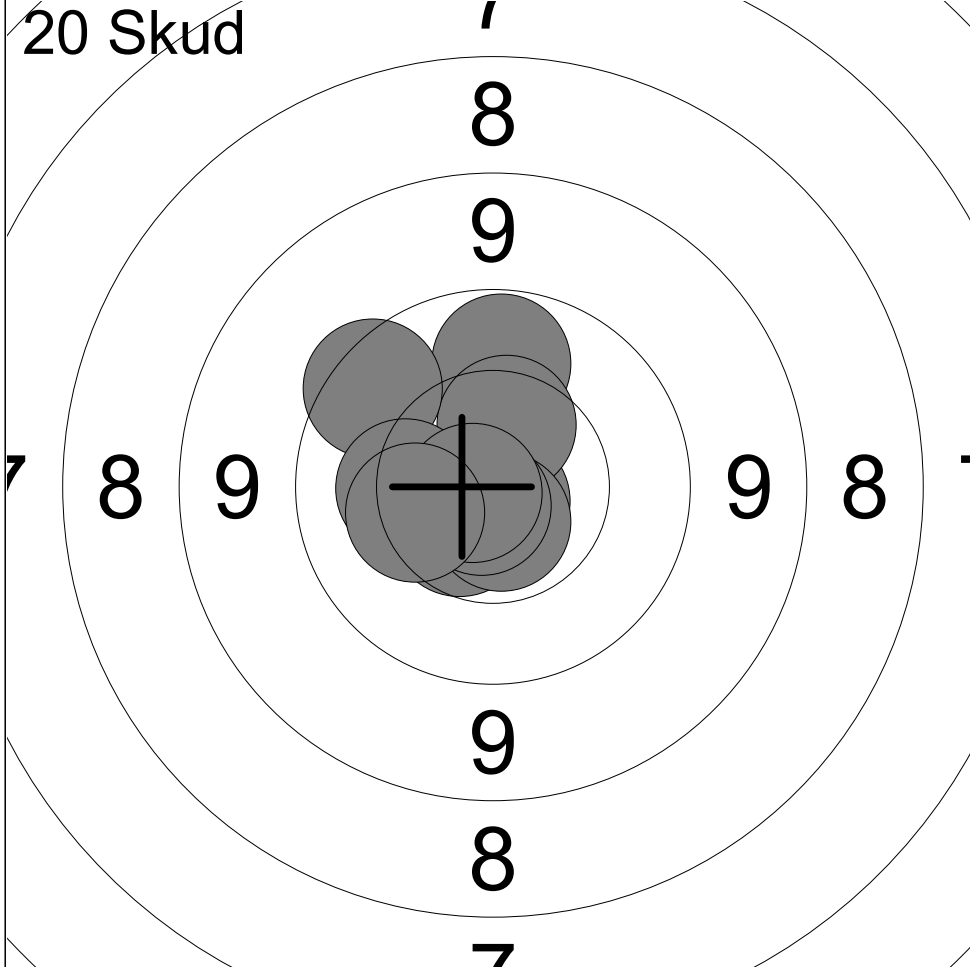

1:	10.8x	↘
2:	10.0	↑
3:	10.5	↑
4:	9.7	↖
5:	10.5	↙
6:	10.3	←
7:	10.7x	↘
8:	10.8x	↙
9:	10.8x	←
10:	10.3	←

Serie	99 (4x)
Total	99 (4x)

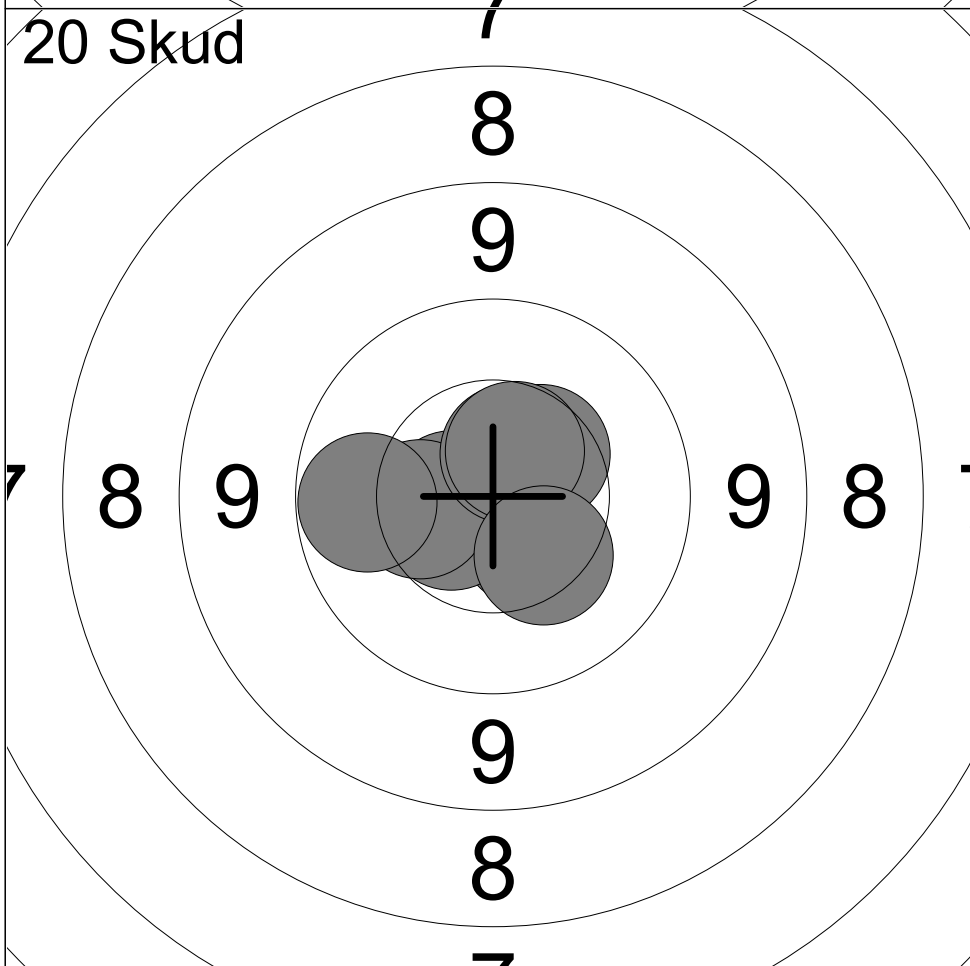

11:	10.8x	↓
12:	10.5	↘
13:	10.6x	←
14:	10.6	↙
15:	10.5	↗
16:	10.4	←
17:	10.0	←
18:	10.6x	↗
19:	10.6	↗
20:	10.3	↘

Serie	100 (3x)
Total	199 (7x)

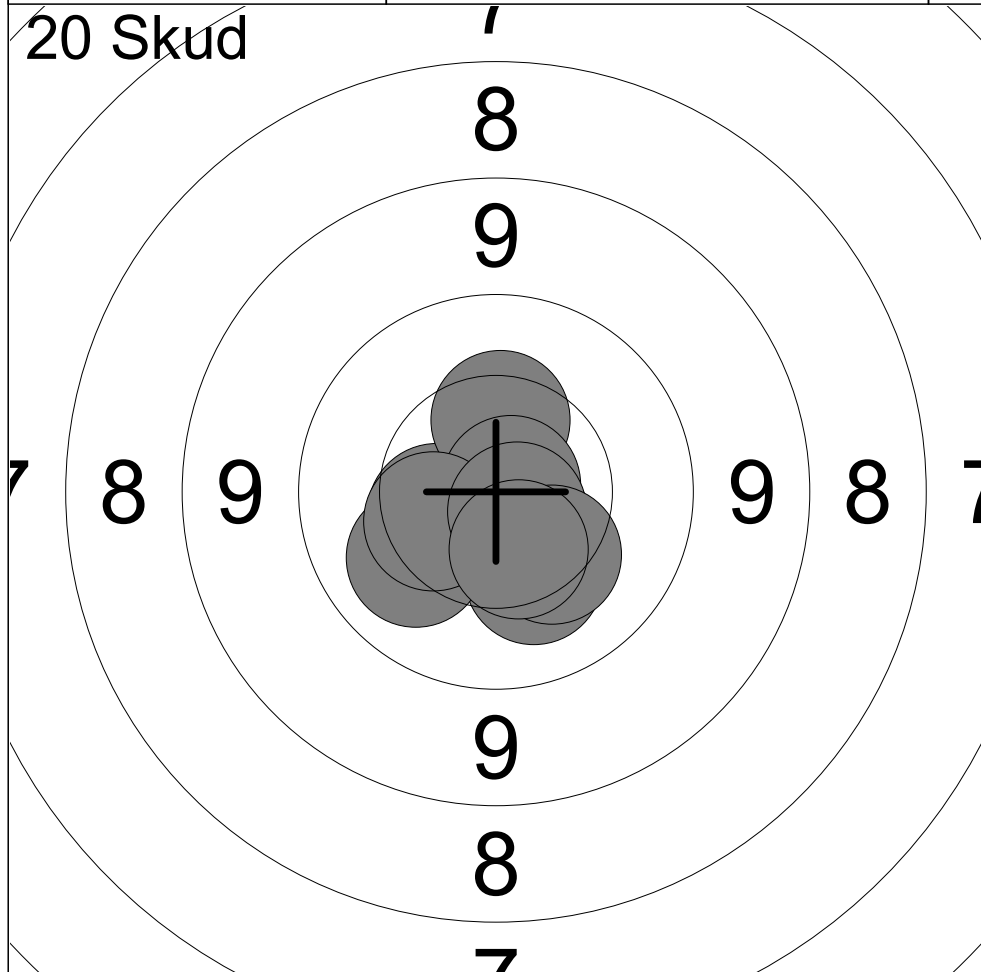

1:	10.5	←
2:	10.4	↑
3:	10.6x	↘
4:	10.2	↘
5:	10.8x	→
6:	10.1	←
7:	10.4	←
8:	10.7x	↘
9:	10.3	↘
10:	10.5	↘

Serie	100 (3x)
Total	100 (3x)

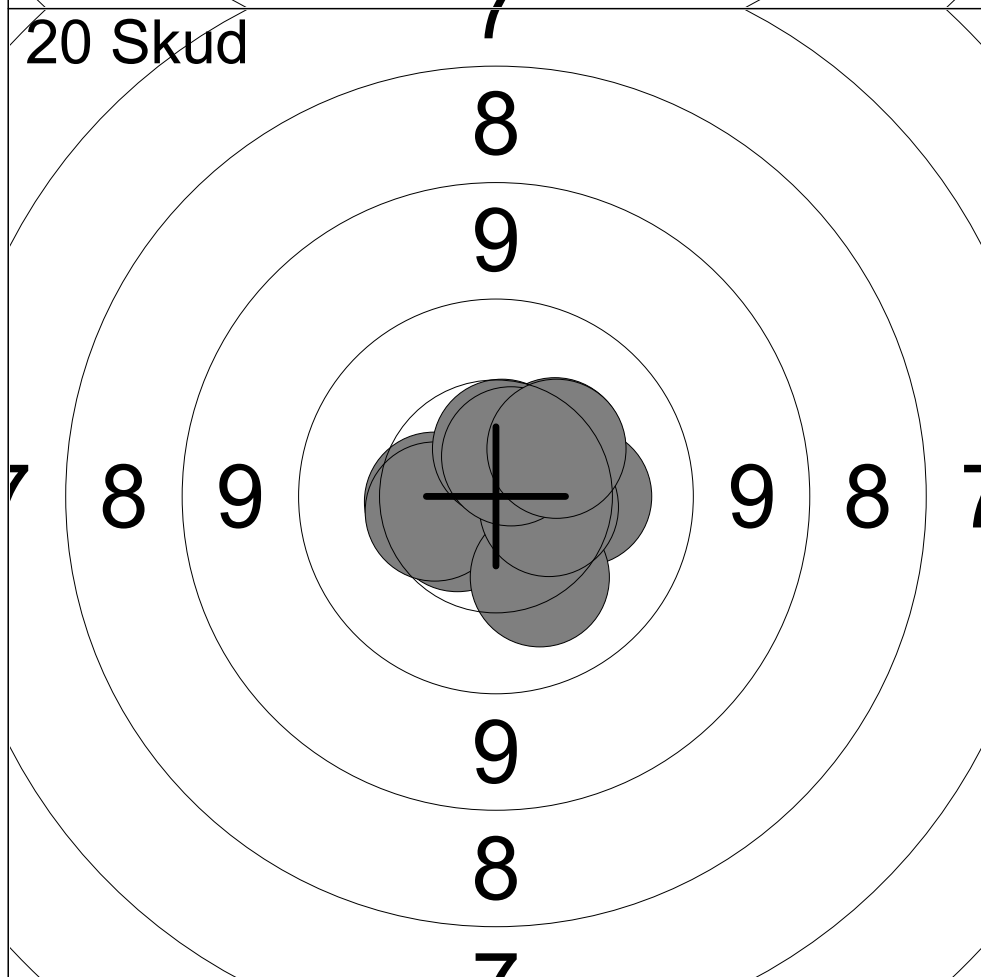

11:	10.5	←
12:	10.3	→
13:	10.3	↗
14:	10.6x	←
15:	10.5	←
16:	10.6	↑
17:	10.2	↘
18:	10.5	→
19:	10.6x	↑
20:	10.3	↗

Serie	100 (2x)
Total	200 (5x)

20 Skud

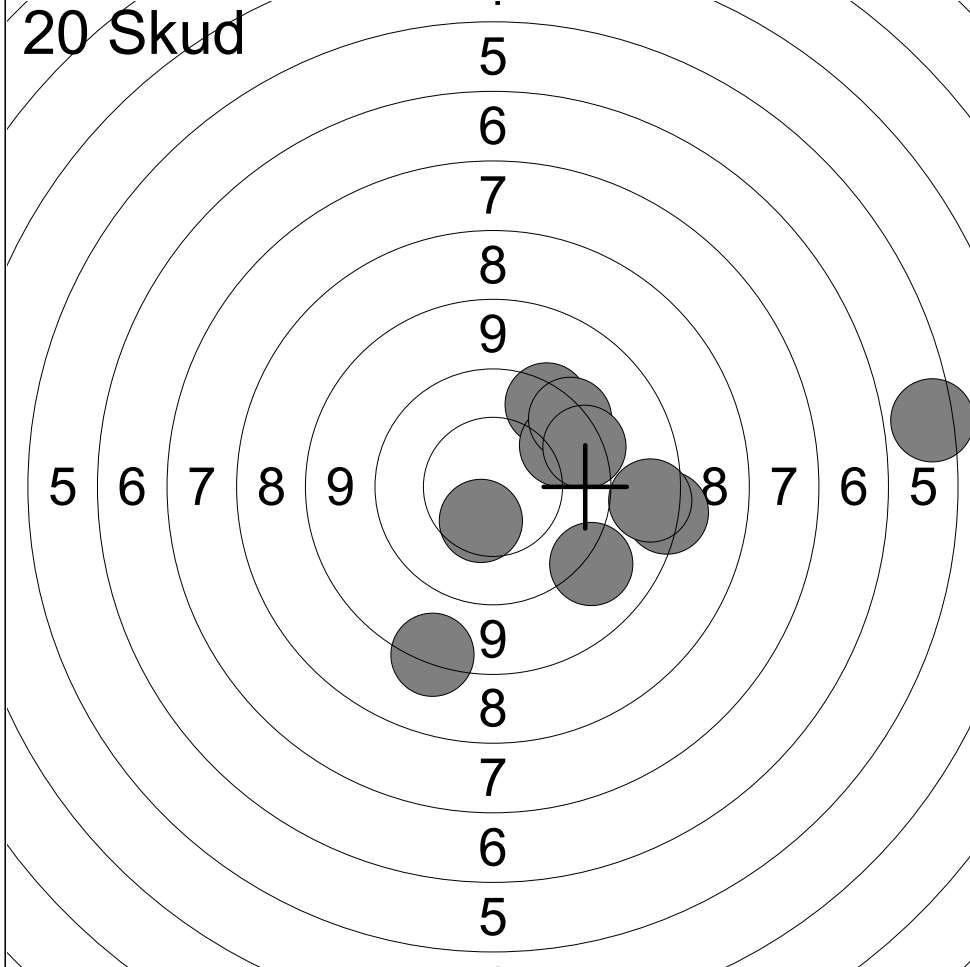

1:	8.5	→
2:	4.6	→
3:	9.6	↗
4:	8.5	↘
5:	9.2	↘
6:	8.8	→
7:	9.9	↗
8:	9.6	↗
9:	10.5	↘
10:	9.6	↗

Serie	83 (0x)
Total	83 (0x)

20 Skud

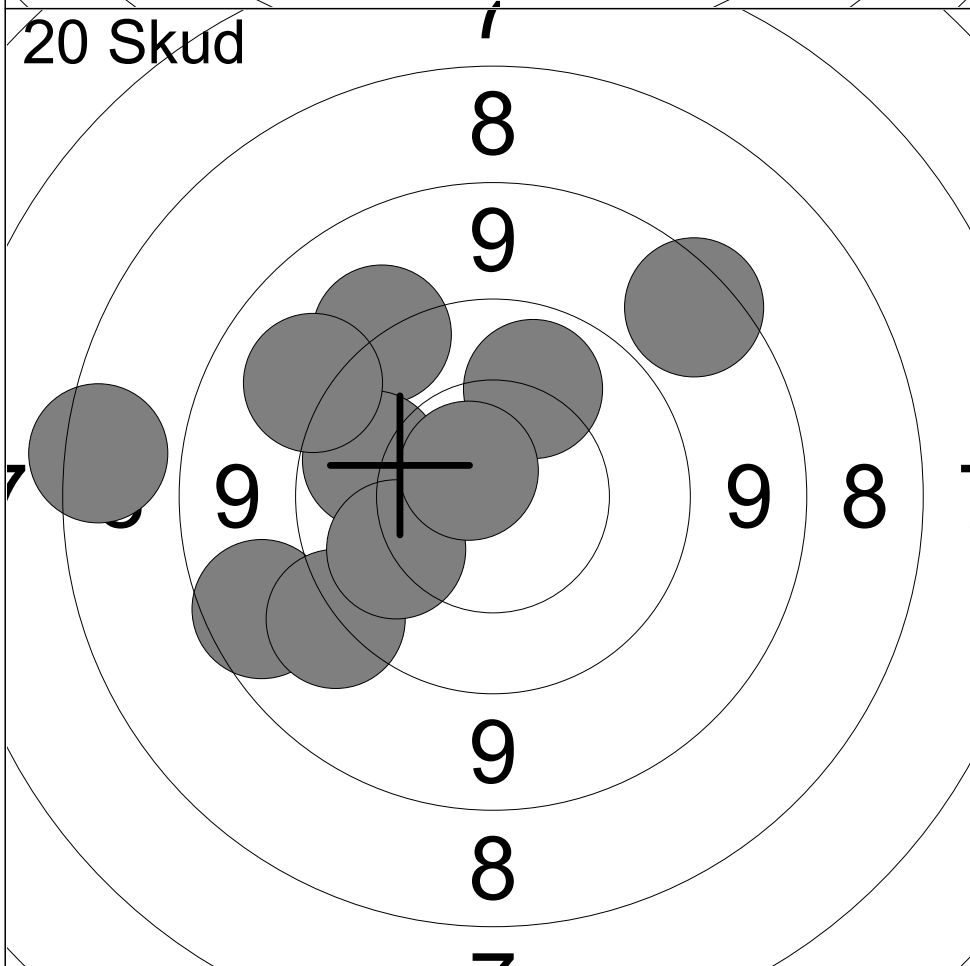

11:	9.4	↖
12:	10.1	↗
13:	8.8	↙
14:	9.3	↙
15:	10.0	↙
16:	9.2	↗
17:	7.6	↙
18:	10.1	↙
19:	8.7	↗
20:	10.7x	↖

Serie	90 (1x)
Total	173 (1x)

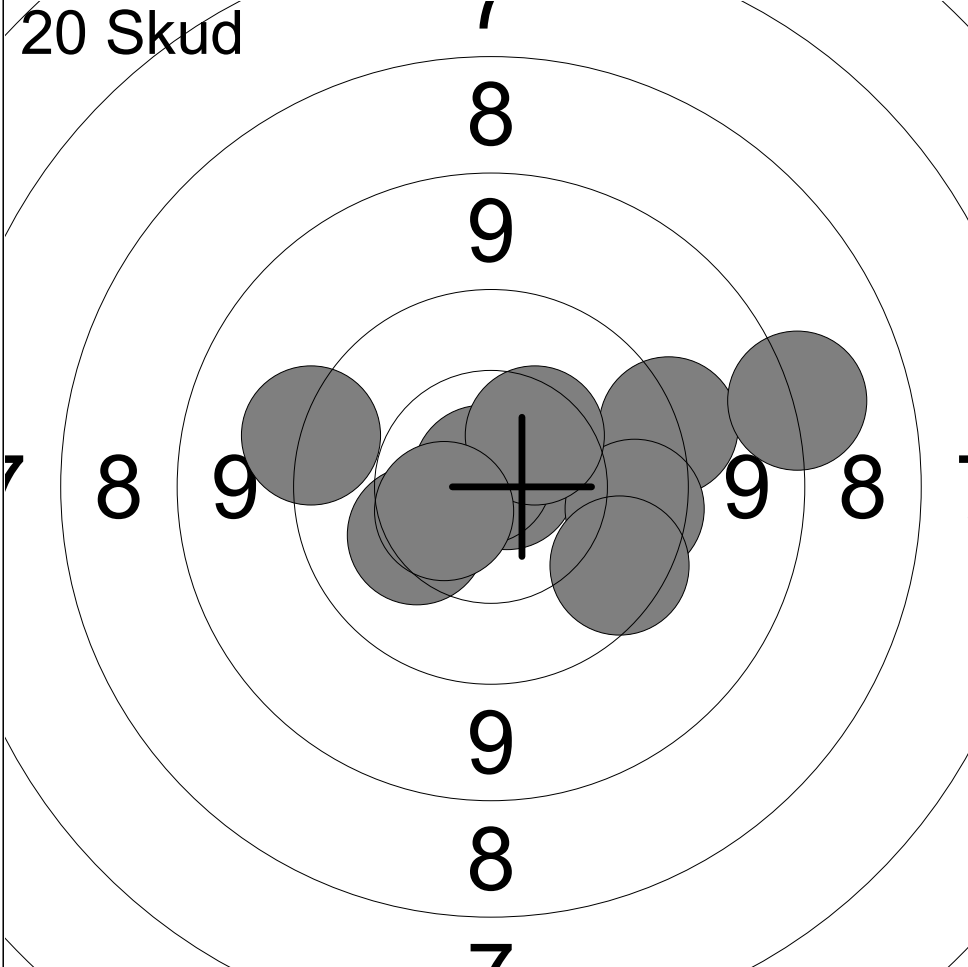

1:	9.4	➔
2:	10.8x	➔
3:	9.8	➔
4:	8.3	➔
5:	10.3	↙
6:	9.8	↘
7:	10.8x	↗
8:	9.4	↖
9:	10.4	↗
10:	10.5	↖

Serie	94 (2x)
Total	94 (2x)

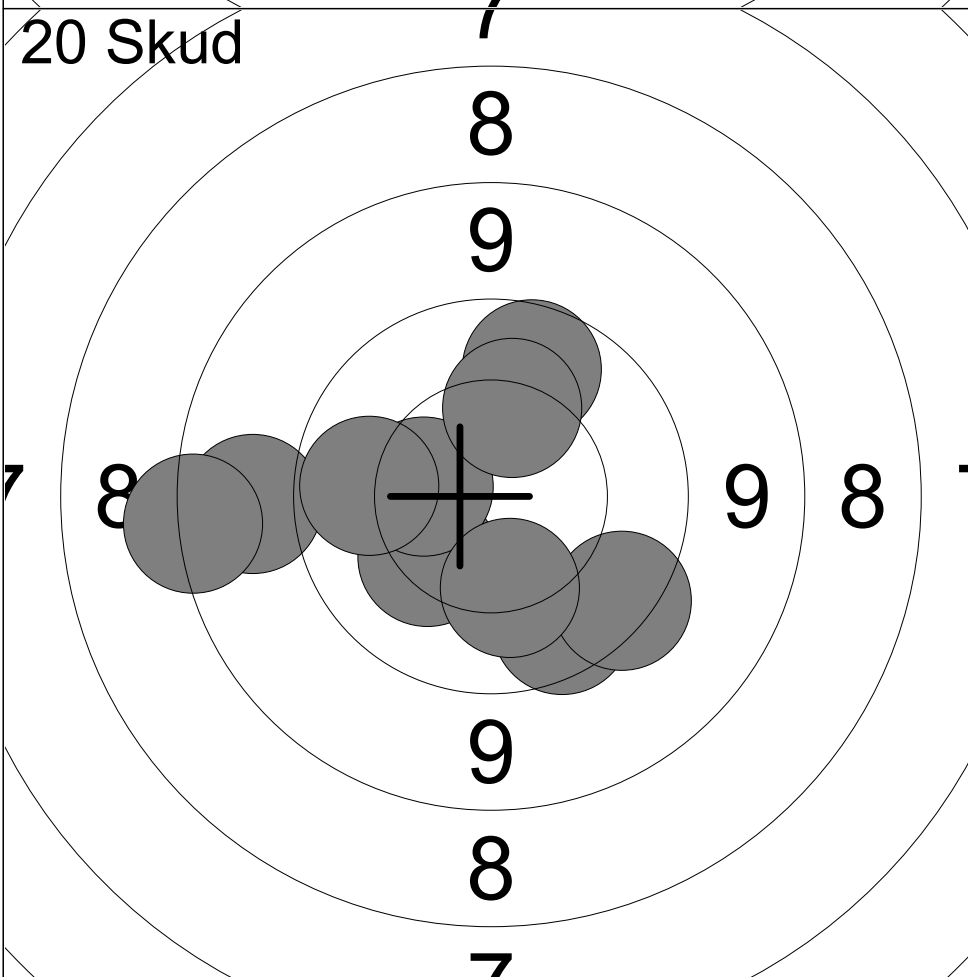

11:	10.3	↙
12:	9.0	←
13:	10.4	←
14:	9.9	↗
15:	9.8	↘
16:	9.6	↘
17:	10.2	↗
18:	8.5	←
19:	10.2	↘
20:	10.0	←

Serie	94 (0x)
Total	188 (2x)

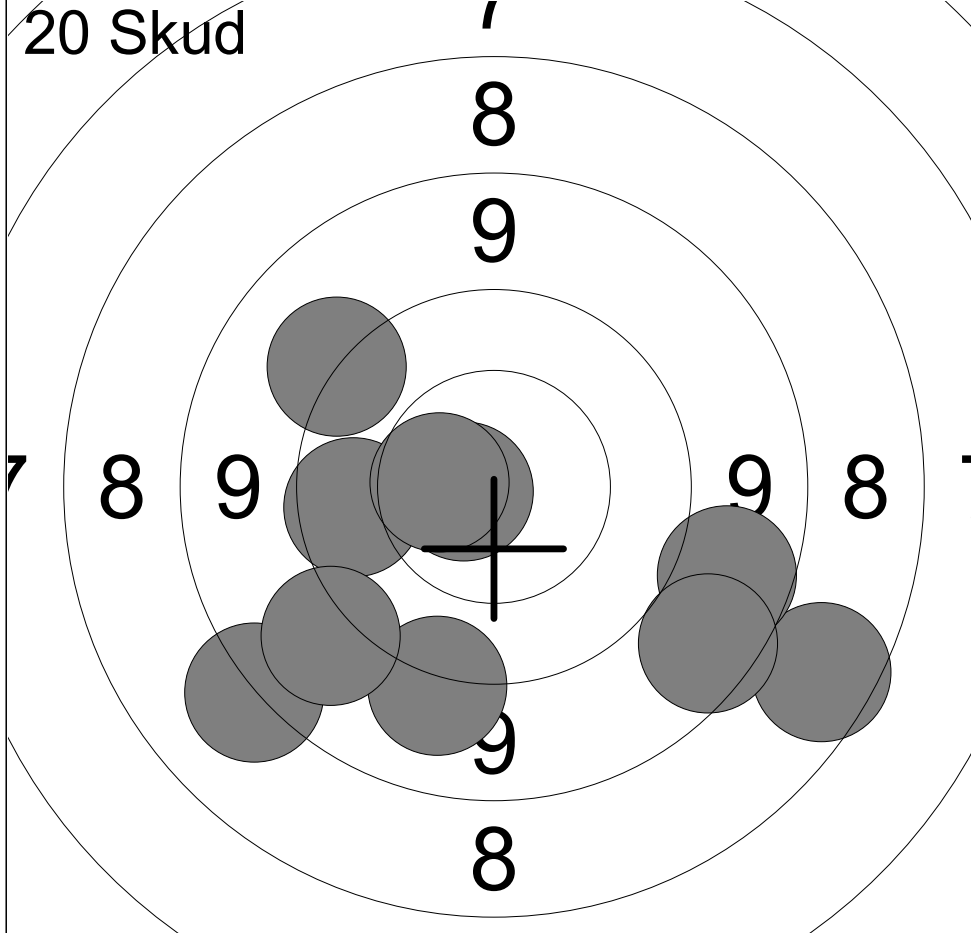

1:	7.8	↘
2:	9.8	←
3:	10.7x	←
4:	9.3	↘
5:	8.3	↙
6:	8.9	↘
7:	8.8	↘
8:	9.1	↘
9:	9.3	↗
10:	10.5	←

Serie	87 (1x)
Total	87 (1x)

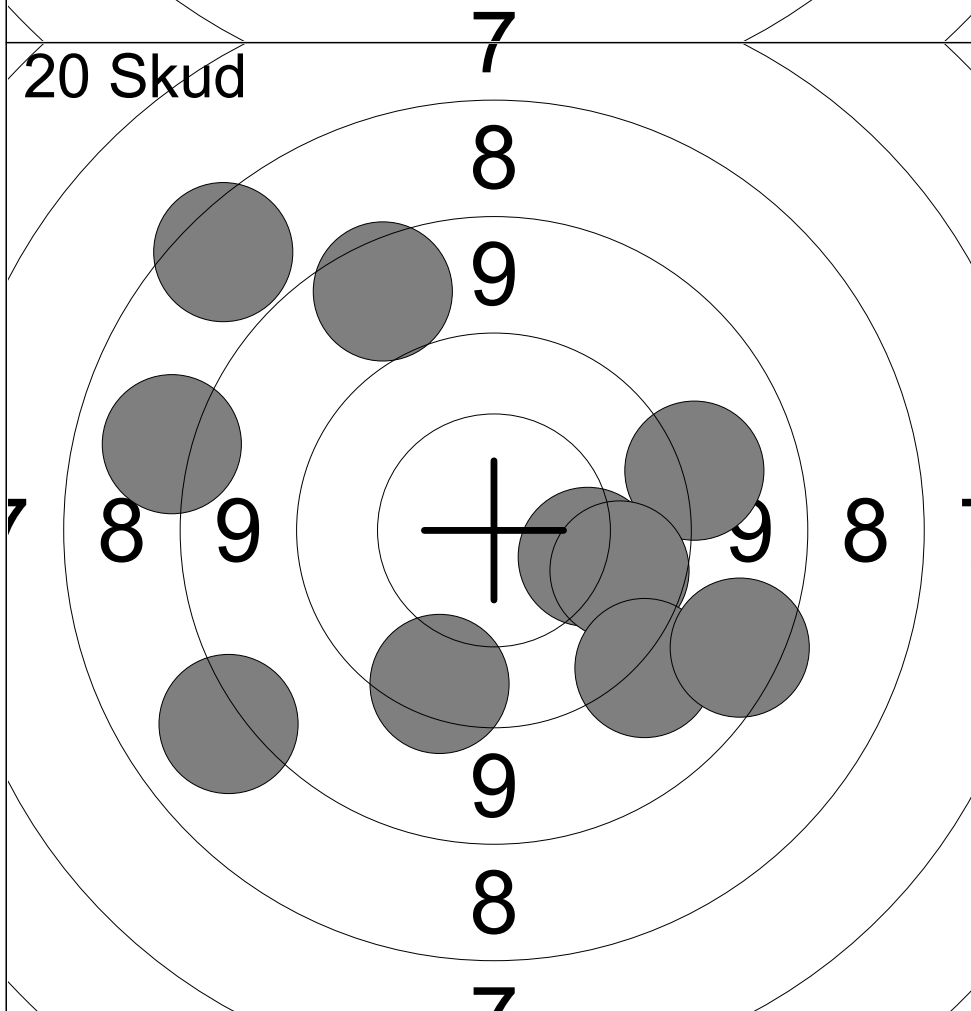

11:	8.2	↙
12:	10.2	→
13:	9.2	→
14:	9.9	↘
15:	9.3	↘
16:	8.2	↖
17:	8.8	↗
18:	8.7	↘
19:	7.7	↗
20:	9.7	↘

Serie	85 (0x)
Total	172 (1x)

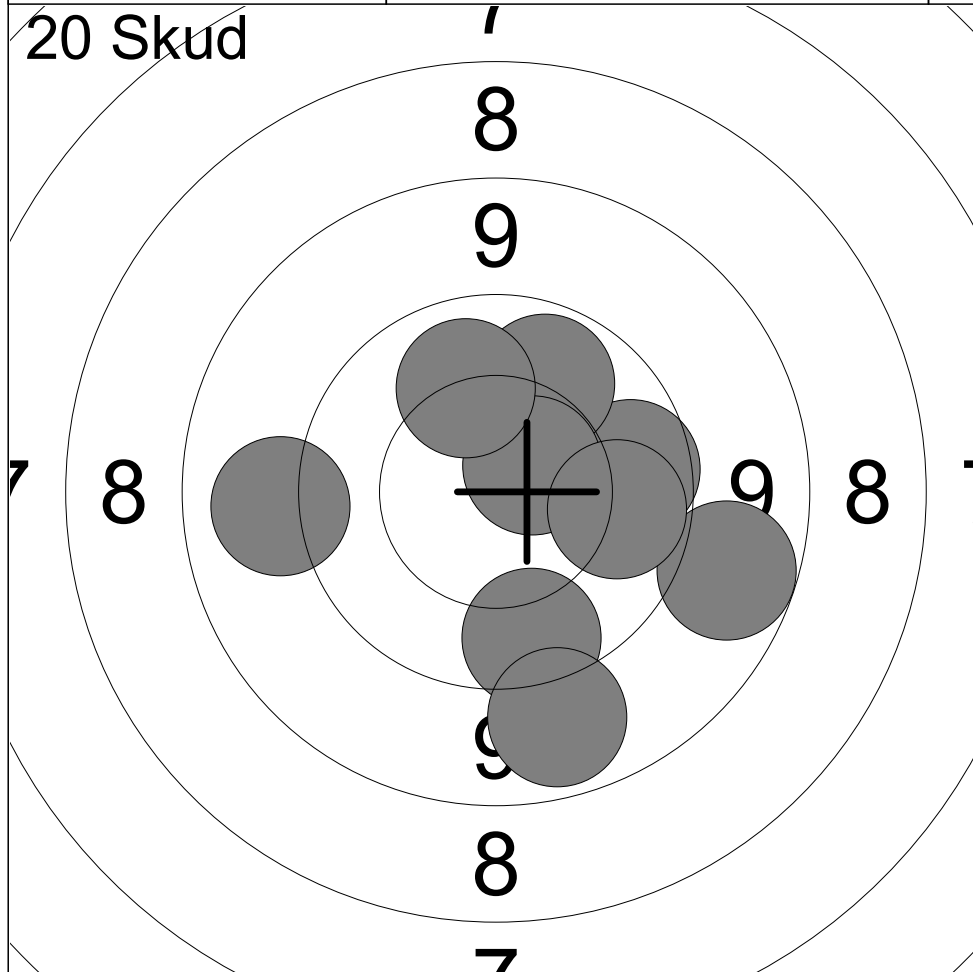

1:	10.4	↗
2:	9.9	→
3:	10.0	↗
4:	9.8	↘
5:	9.0	→
6:	10.6x	↗
7:	10.0	→
8:	9.0	↘
9:	10.1	↗
10:	9.2	←

Serie	95 (1x)
Total	95 (1x)

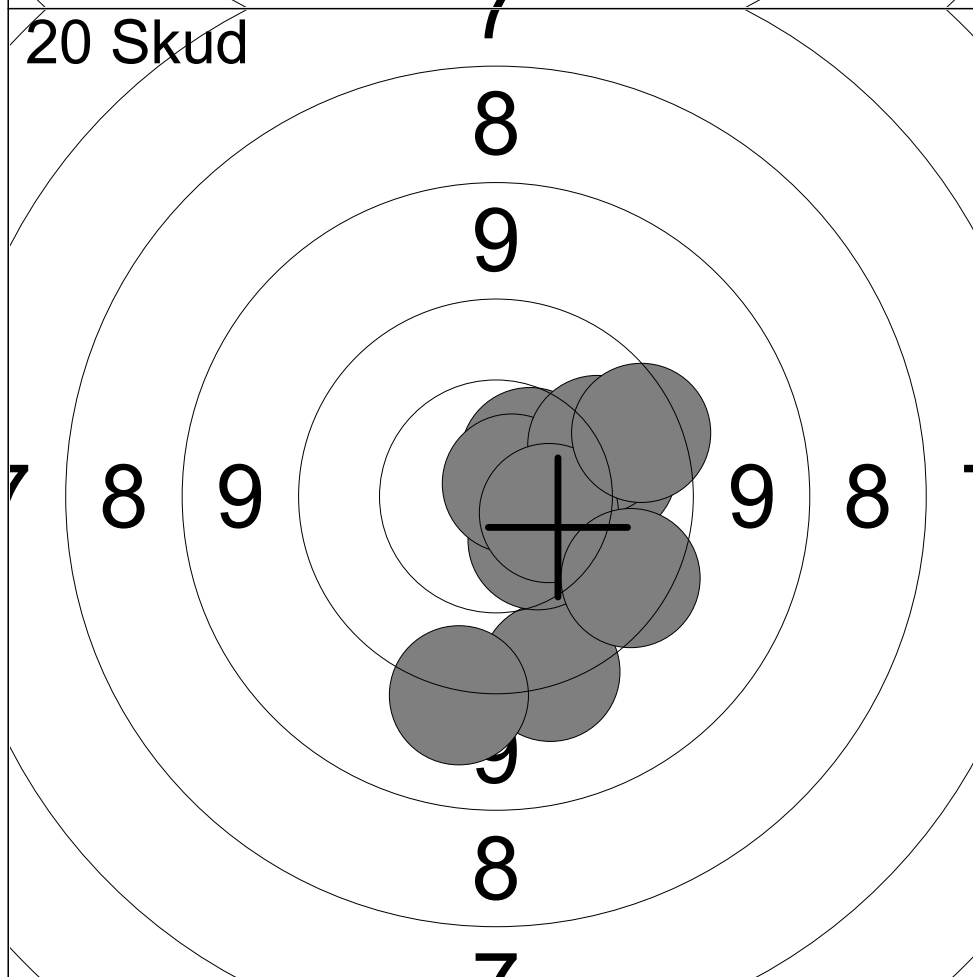

11:	9.5	↘
12:	10.1	→
13:	10.5	↘
14:	10.5	↗
15:	10.8x	↗
16:	10.1	↗
17:	10.5	→
18:	9.7	↗
19:	9.7	↘
20:	9.3	↘

Serie	96 (1x)
Total	191 (2x)

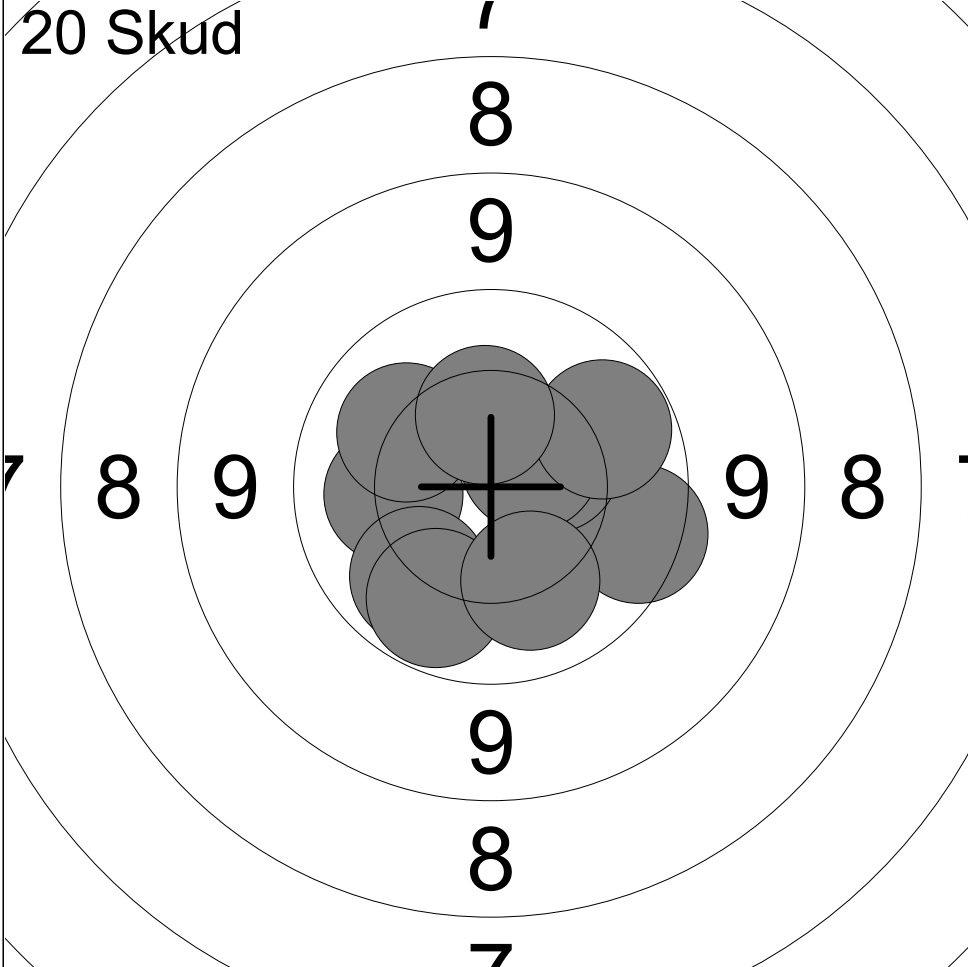

1:	10.2	←
2:	10.1	↙
3:	9.7	→
4:	10.0	↙
5:	10.4	→
6:	10.6	↗
7:	10.0	↗
8:	10.2	↖
9:	10.4	↑
10:	10.2	↘

Serie	99 (0x)
Total	99 (0x)

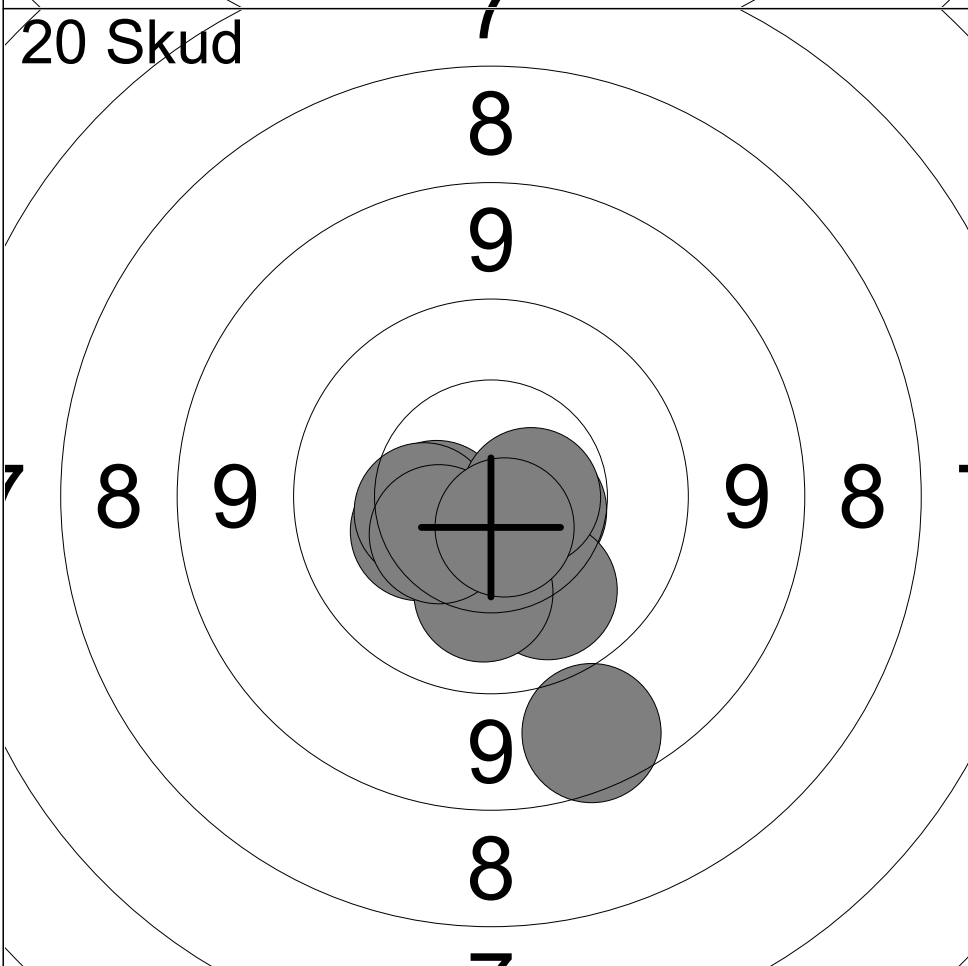

11:	10.3	↙
12:	10.5	←
13:	10.4	←
14:	10.6	→
15:	10.1	↙
16:	10.6x	→
17:	10.2	↘
18:	10.4	↖
19:	10.7x	↘
20:	8.8	↘

Serie	98 (2x)
Total	197 (2x)

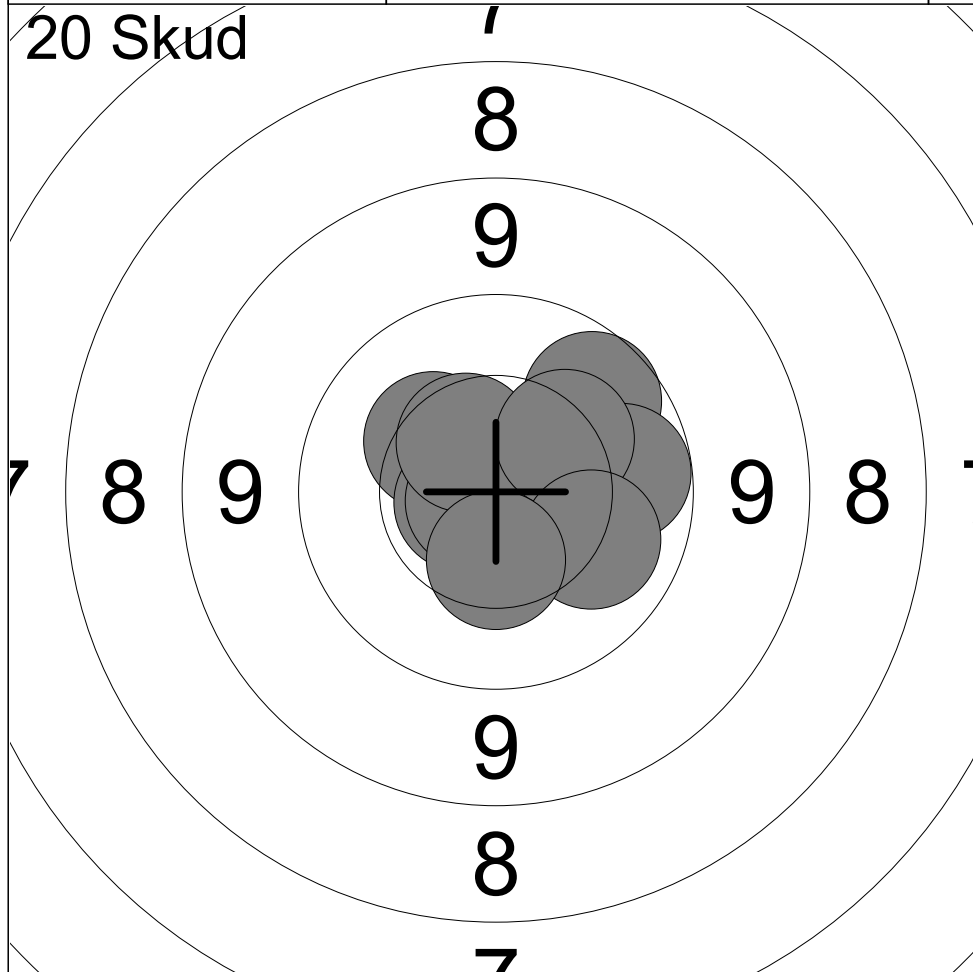

1:	9.9	↗
2:	10.3	↖
3:	10.7x	↙
4:	10.8x	↑
5:	10.8x	↖
6:	10.0	→
7:	10.5	↗
8:	10.3	↗
9:	10.1	↘
10:	10.4	↓

Serie	99 (3x)
Total	99 (3x)

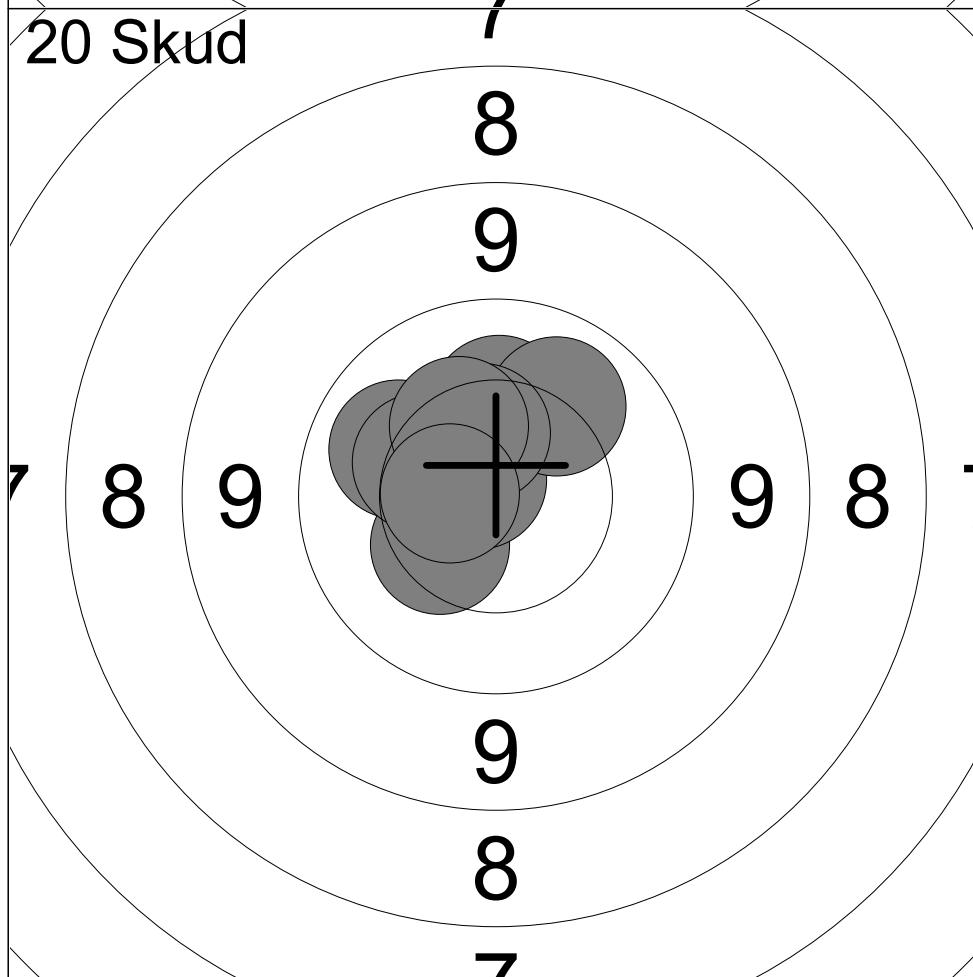

11:	10.4	↖
12:	10.3	↑
13:	10.8x	↖
14:	10.1	↖
15:	10.2	↑
16:	10.1	↗
17:	10.3	↖
18:	10.4	↑
19:	10.3	↗
20:	10.6x	↙

Serie	100 (2x)
Total	199 (5x)

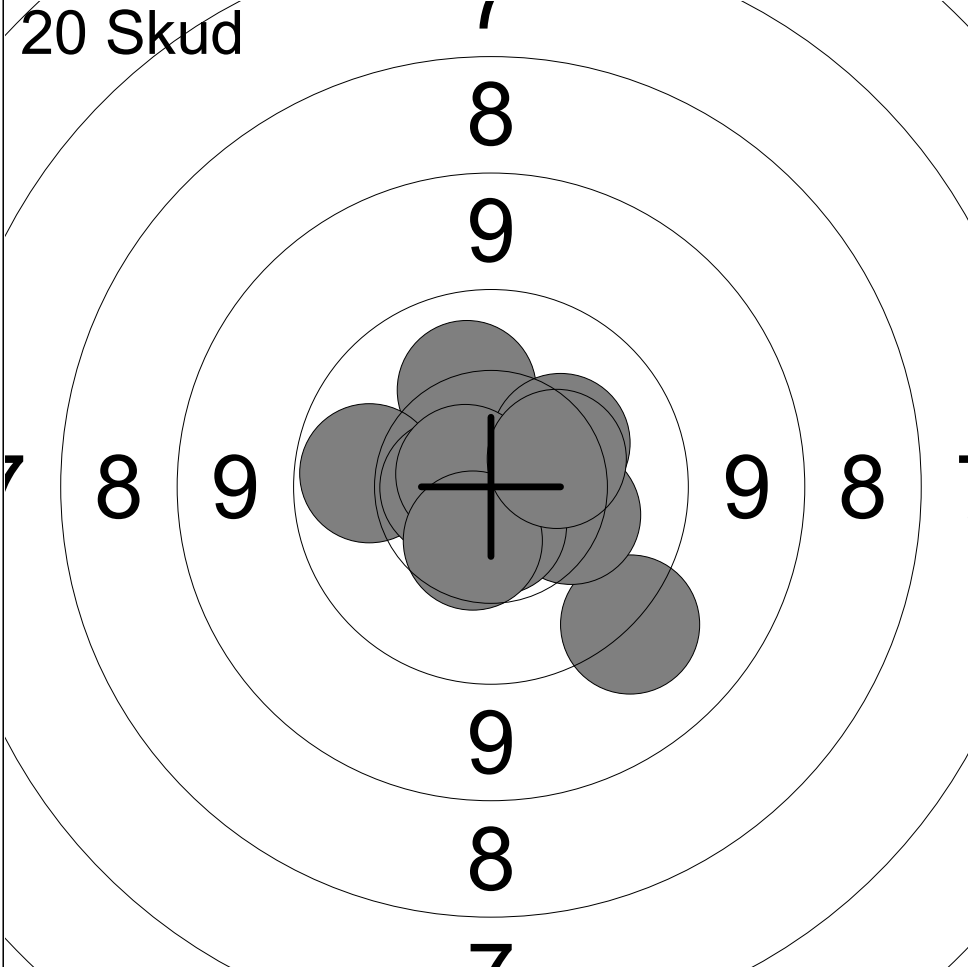

1:	10.2	↖
2:	9.4	↘
3:	10.3	→
4:	10.0	←
5:	10.6x	↘
6:	10.3	↗
7:	10.6x	←
8:	10.7x	↖
9:	10.5	↘
10:	10.4	↗

Serie	99 (3x)
Total	99 (3x)

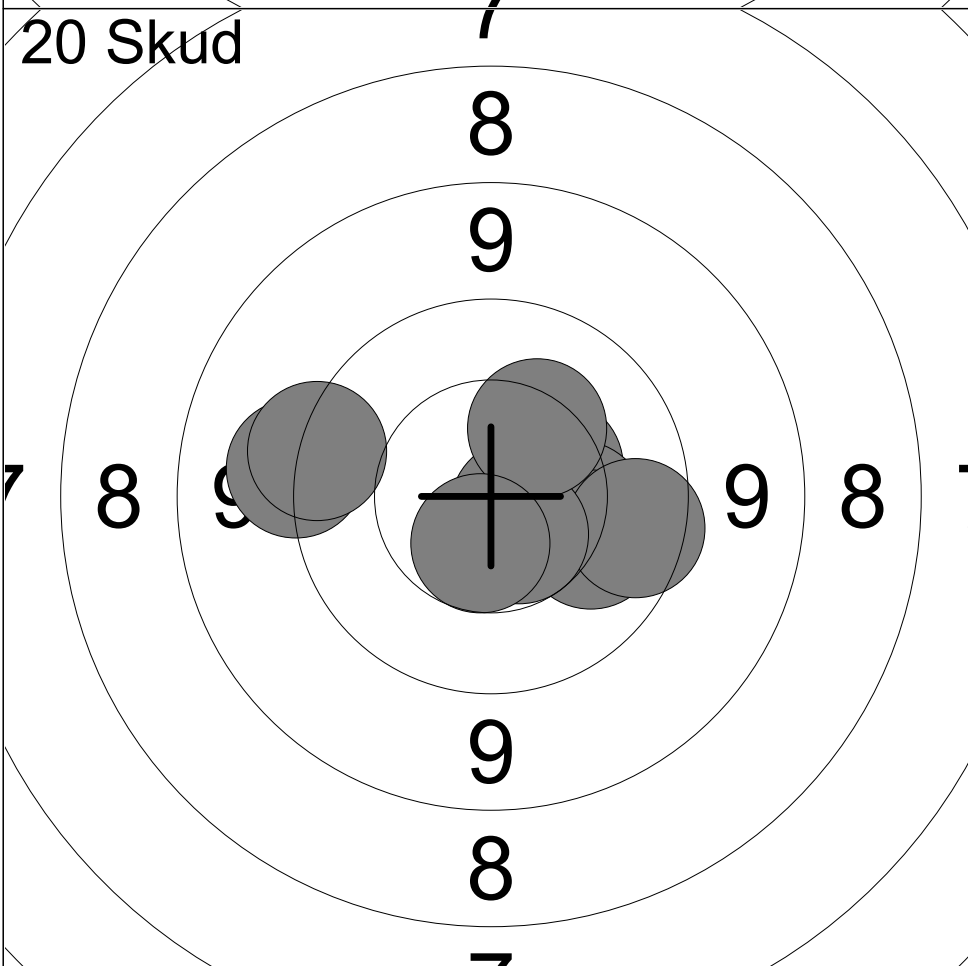

11:	10.4	↗
12:	10.7x	↘
13:	10.3	→
14:	10.1	↘
15:	9.8	↘
16:	10.6	↘
17:	9.4	←
18:	9.5	←
19:	10.3	↗
20:	10.6	↘

Serie	97 (1x)
Total	196 (4x)

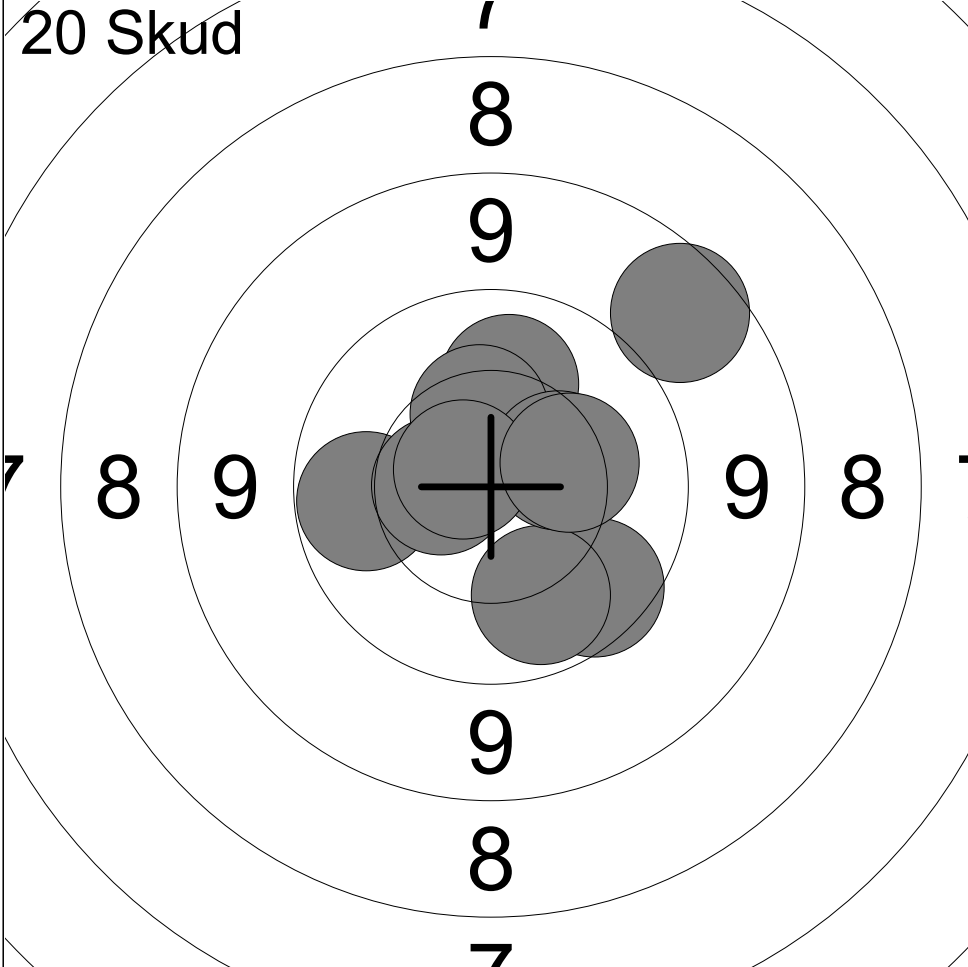

1:	10.0	←
2:	10.6	←
3:	9.8	↘
4:	10.1	↑
5:	8.8	↗
6:	10.4	↑
7:	10.0	↘
8:	10.4	↗
9:	10.7x	↖
10:	10.3	↗

Serie	97 (1x)
Total	97 (1x)

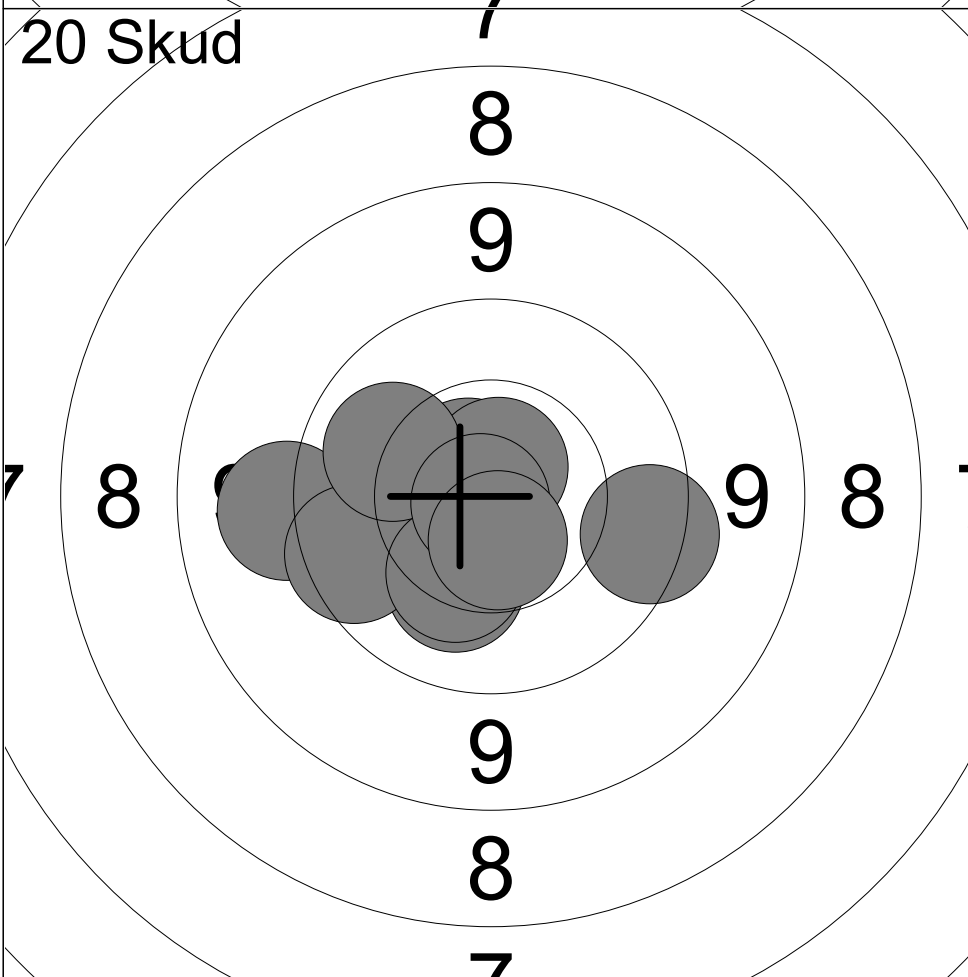

11:	10.2	↘
12:	9.6	→
13:	9.3	←
14:	10.7x	↗
15:	9.8	←
16:	10.7x	↑
17:	10.3	↘
18:	10.1	↖
19:	10.9x	↖
20:	10.6x	↓

Serie	97 (4x)
Total	194 (5x)

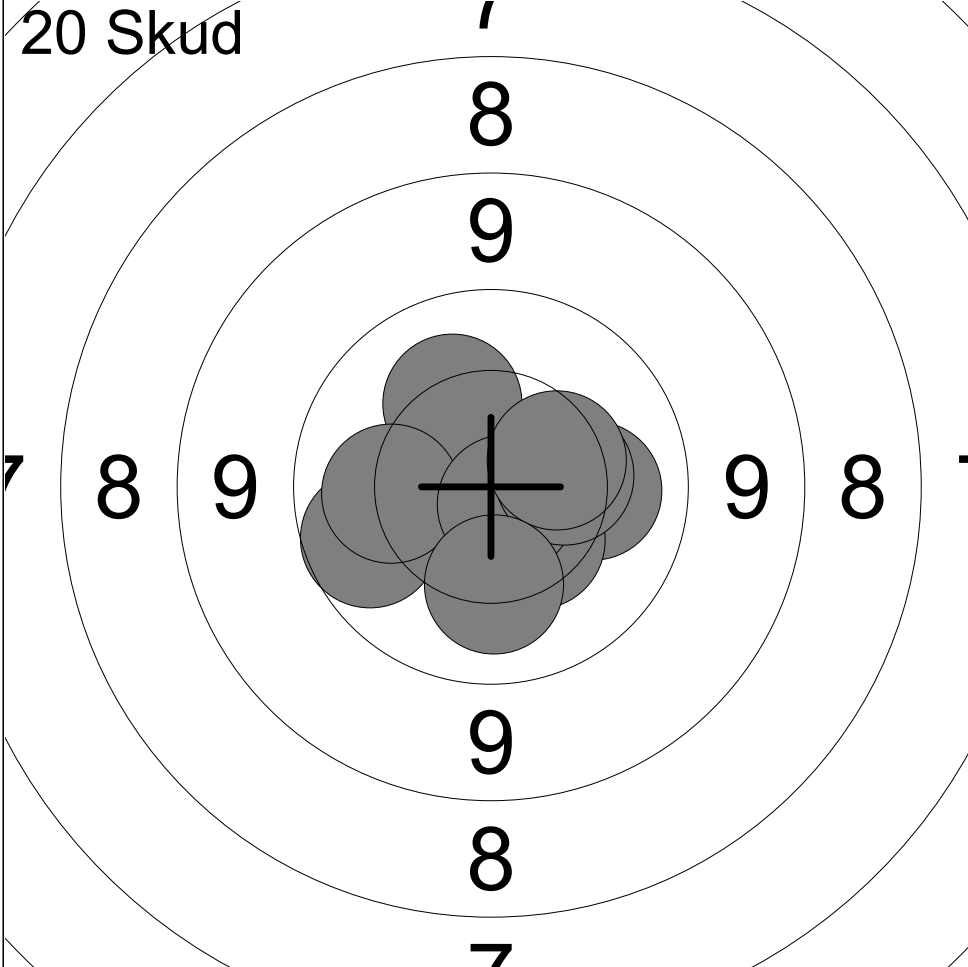

1:	10.8x	←
2:	9.9	↙
3:	10.2	↗
4:	10.2	←
5:	10.2	→
6:	10.4	↘
7:	10.8x	↘
8:	10.4	→
9:	10.4	↗
10:	10.2	↓

Serie	99 (2x)
Total	99 (2x)



11:	10.7x	↗
12:	10.6x	↑
13:	10.5	↘
14:	10.6x	↘
15:	10.8x	←
16:	10.4	↗
17:	10.7x	↗
18:	10.7x	←
19:	10.2	↗
20:	10.3	→

Serie	100 (6x)
Total	199 (8x)

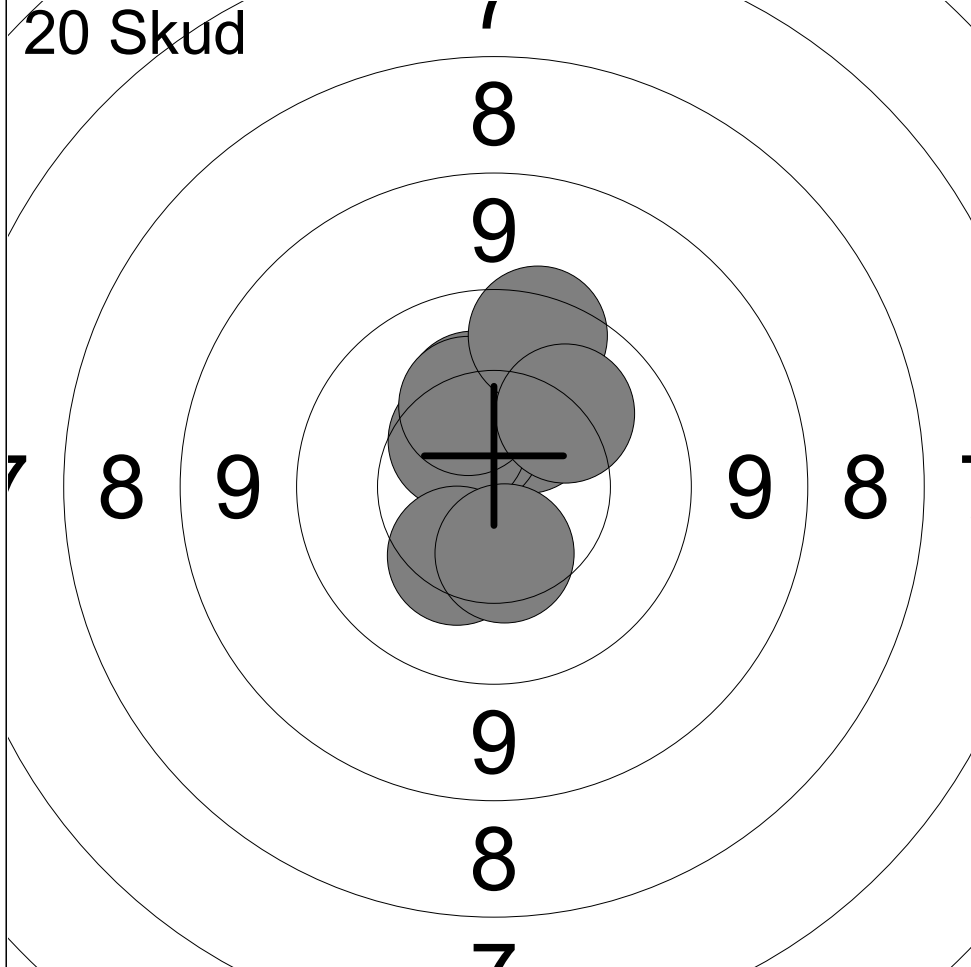

1:	10.2	↑
2:	10.4	↗
3:	10.3	↑
4:	10.5	↖
5:	10.5	↖
6:	10.3	↙
7:	10.3	↑
8:	10.4	↓
9:	9.7	↑
10:	10.1	↗

Serie	99 (0x)
Total	99 (0x)

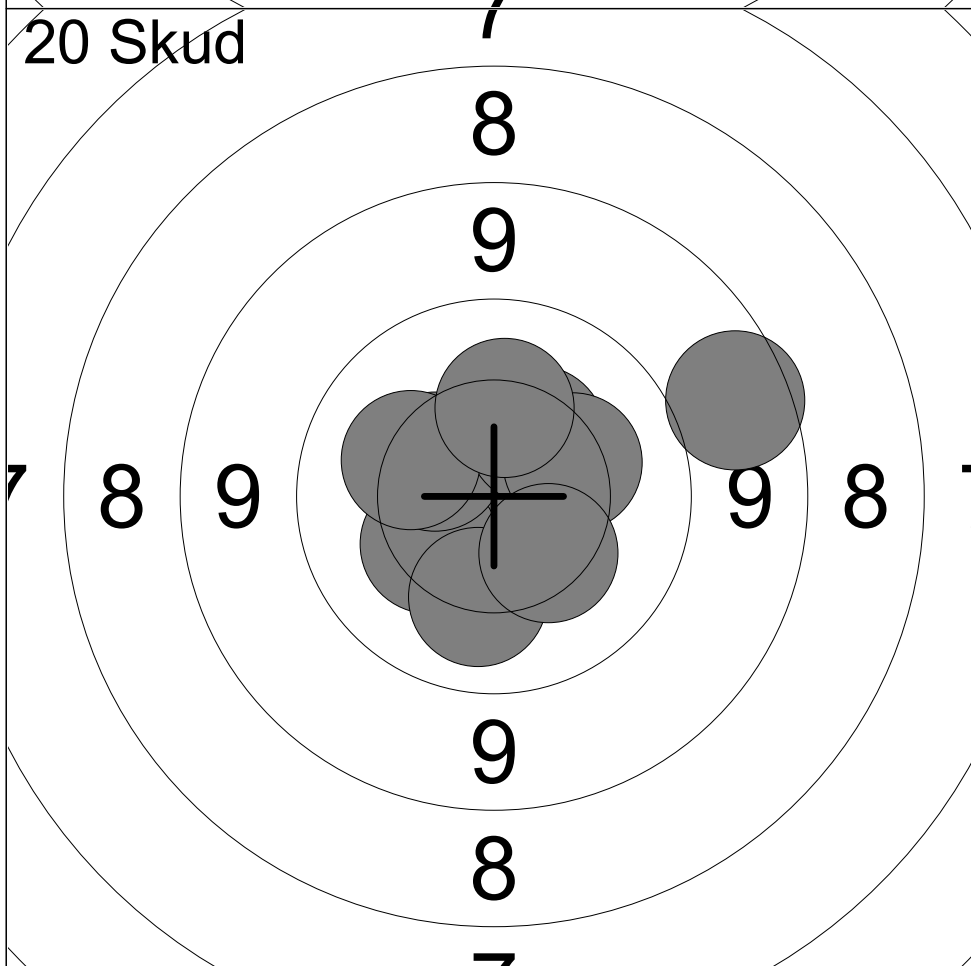

11:	10.7x	←
12:	10.3	↙
13:	10.4	↖
14:	10.4	↗
15:	10.2	↓
16:	10.2	↖
17:	8.8	↗
18:	10.3	↗
19:	10.3	↘
20:	10.3	↑

Serie	98 (1x)
Total	197 (1x)

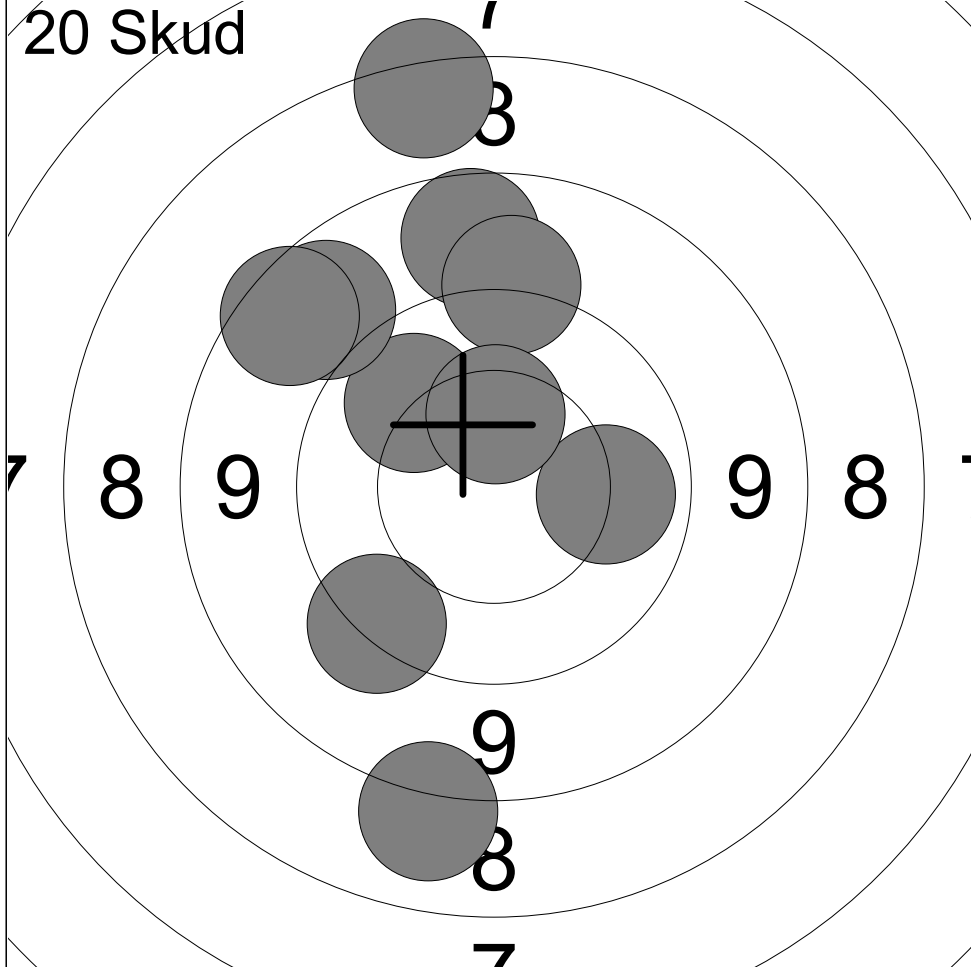

1:	8.9	↑
2:	10.0	↖
3:	9.5	↙
4:	9.0	↗
5:	8.2	↘
6:	10.1	→
7:	8.8	↗
8:	7.6	↑
9:	9.3	↑
10:	10.4	↑

Serie	88 (0x)
Total	88 (0x)

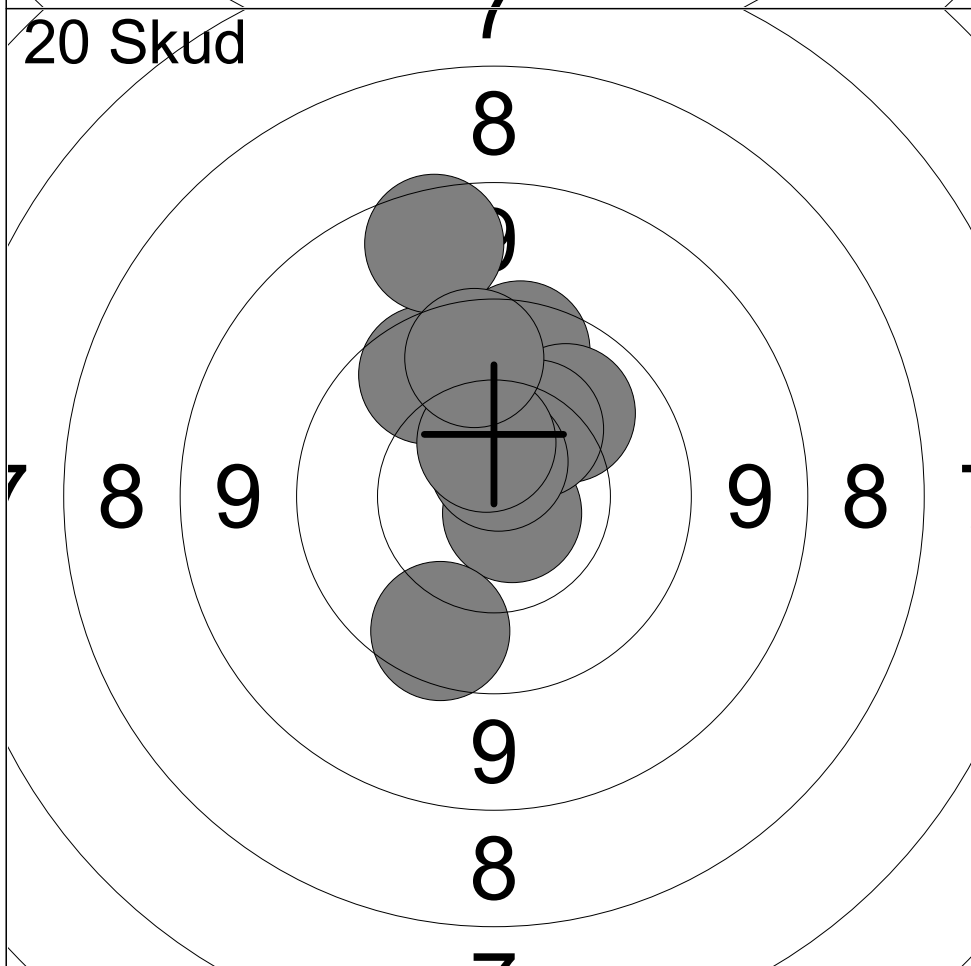

11:	9.9	↖
12:	10.8x	↘
13:	9.8	↑
14:	10.1	↗
15:	10.3	↗
16:	10.7x	↑
17:	9.8	↘
18:	8.8	↑
19:	10.5	↑
20:	9.8	↑

Serie	94 (2x)
Total	182 (2x)

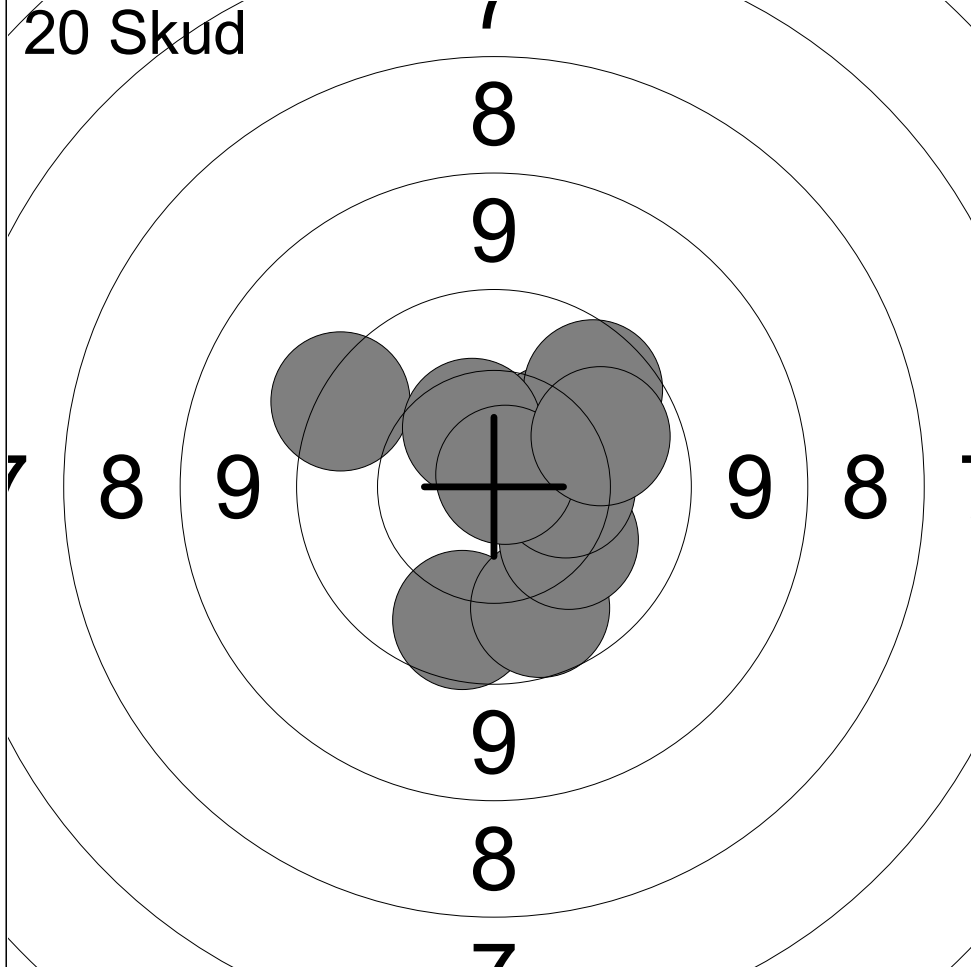

1:	9.9	↘
2:	9.5	↖
3:	9.9	↘
4:	10.3	↗
5:	10.2	↘
6:	10.4	→
7:	9.9	↗
8:	10.5	↖
9:	10.8x	↗
10:	10.0	↗

Serie	96 (1x)
Total	96 (1x)

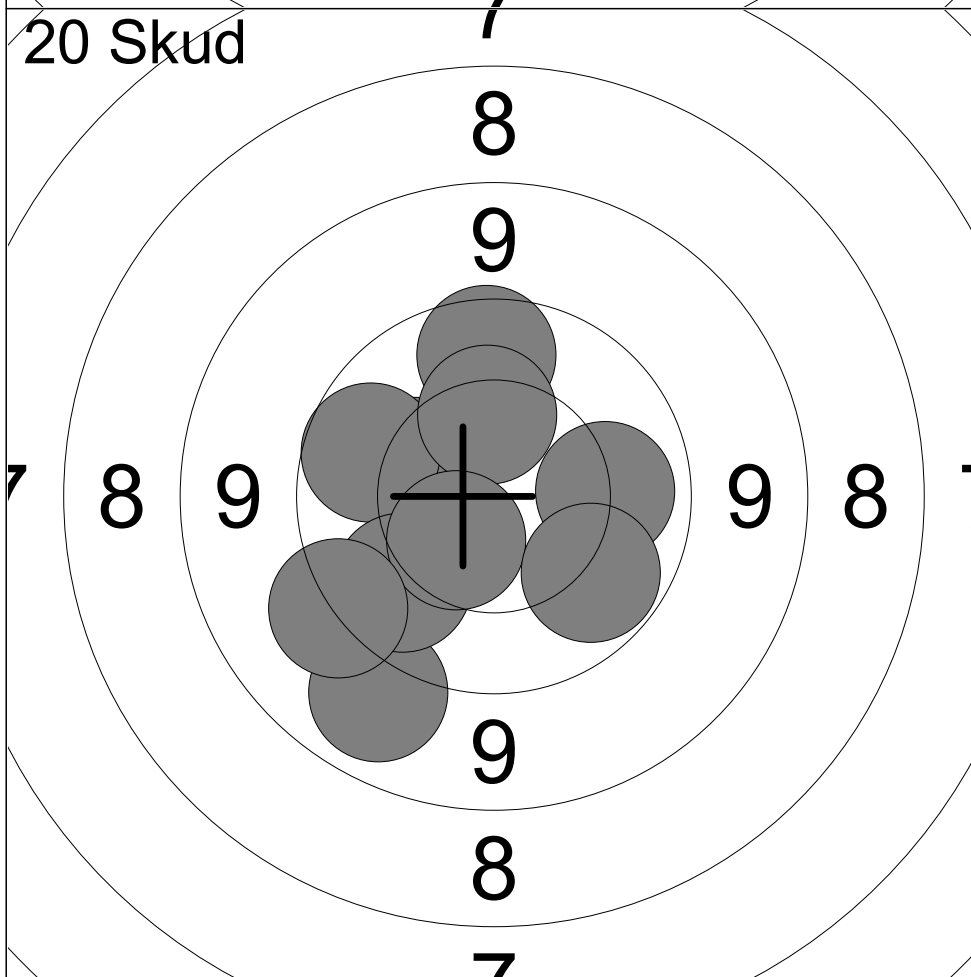

11:	10.3	↖
12:	9.1	↘
13:	9.9	↖
14:	10.1	→
15:	9.8	↑
16:	10.0	↖
17:	10.3	↑
18:	10.5	↘
19:	9.4	↖
20:	10.0	↘

Serie	96 (0x)
Total	192 (1x)

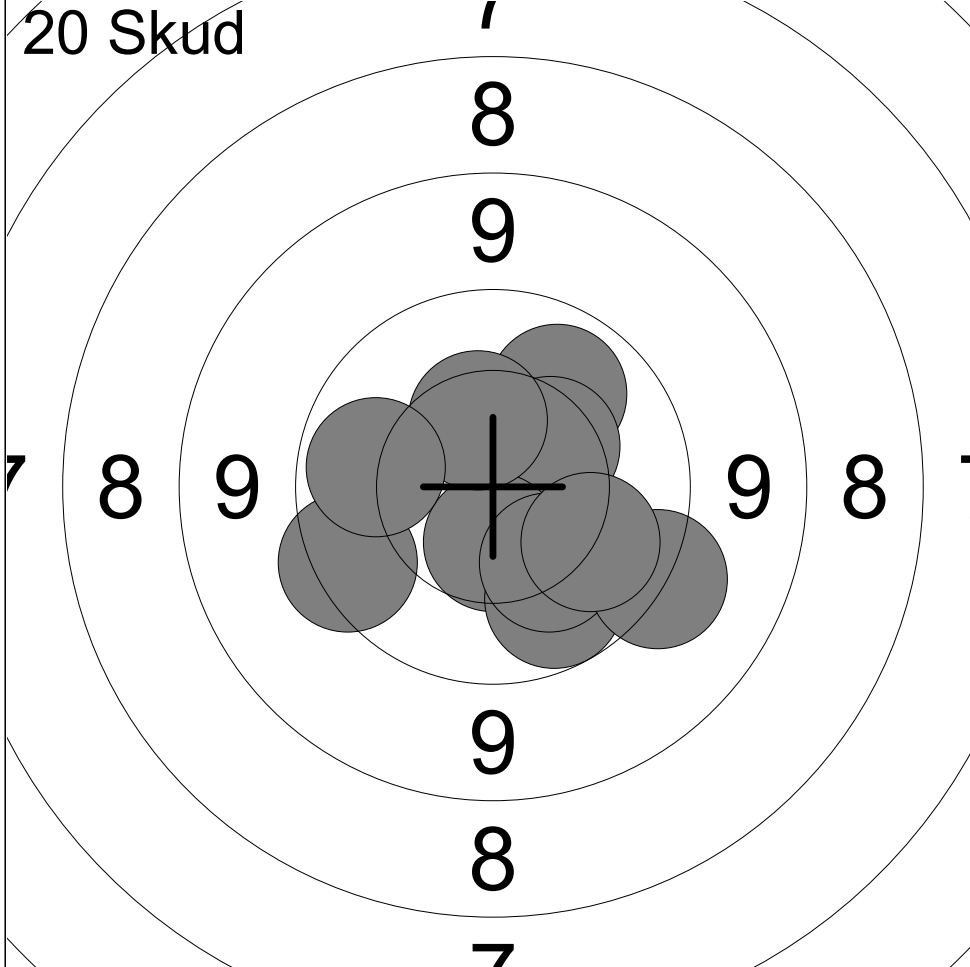

1:	10.1	↗
2:	10.4	↗
3:	10.5	↓
4:	10.4	↖
5:	10.0	↘
6:	10.2	↘
7:	9.4	↘
8:	10.1	↘
9:	9.6	↖
10:	10.0	↖

Serie	98 (0x)
Total	98 (0x)

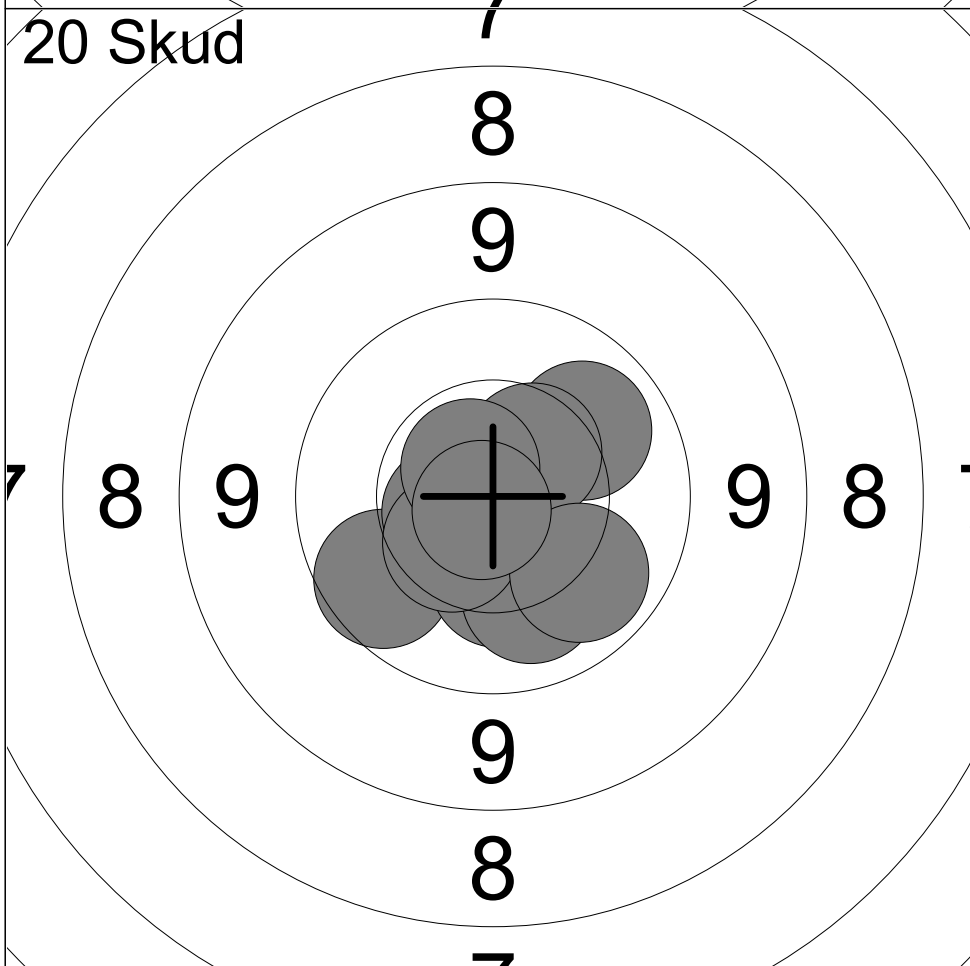

11:	9.9	↖
12:	10.1	↗
13:	10.3	↓
14:	10.6x	↖
15:	10.5	↗
16:	10.1	↘
17:	10.5	↘
18:	10.1	↘
19:	10.7x	↗
20:	10.8x	↘

Serie	99 (3x)
Total	197 (3x)

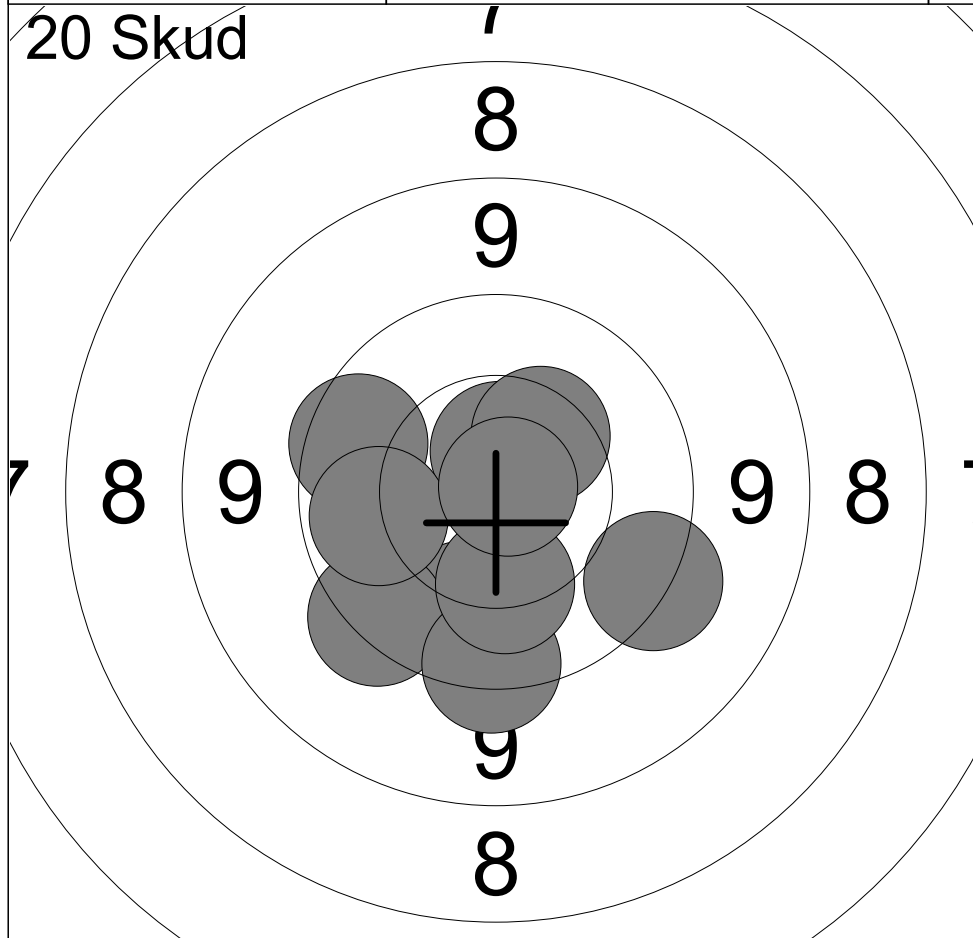

1:	9.5	↘
2:	10.0	↓
3:	9.6	↙
4:	10.6x	↑
5:	9.6	↓
6:	9.8	↖
7:	10.2	↓
8:	10.0	←
9:	10.4	↗
10:	10.8x	↗

Serie	96 (2x)
-------	----------

Total	96 (2x)
-------	----------

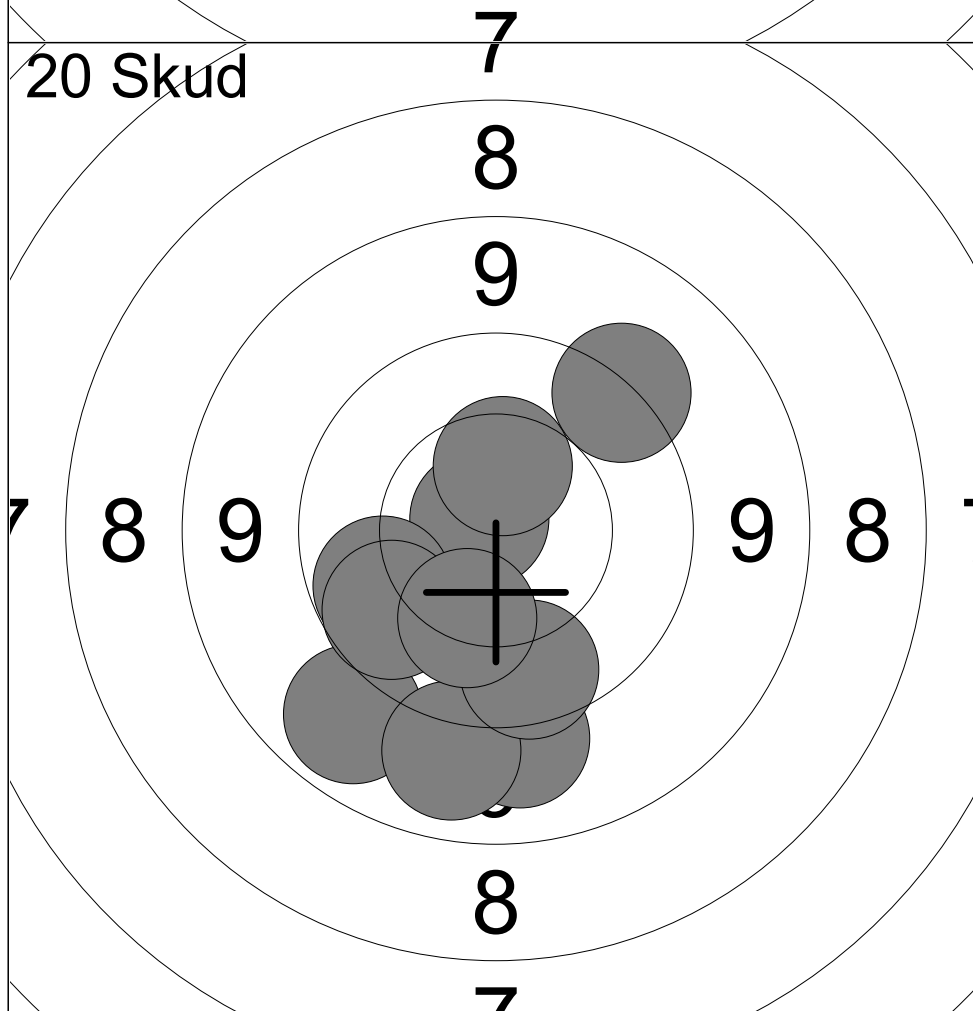

11:	9.2	↓
12:	9.1	↙
13:	9.1	↓
14:	9.8	↓
15:	10.8x	↖
16:	9.5	↗
17:	10.0	↖
18:	9.9	↖
19:	10.4	↑
20:	10.2	↓

Serie	94 (1x)
-------	----------

Total	190 (3x)
-------	-----------

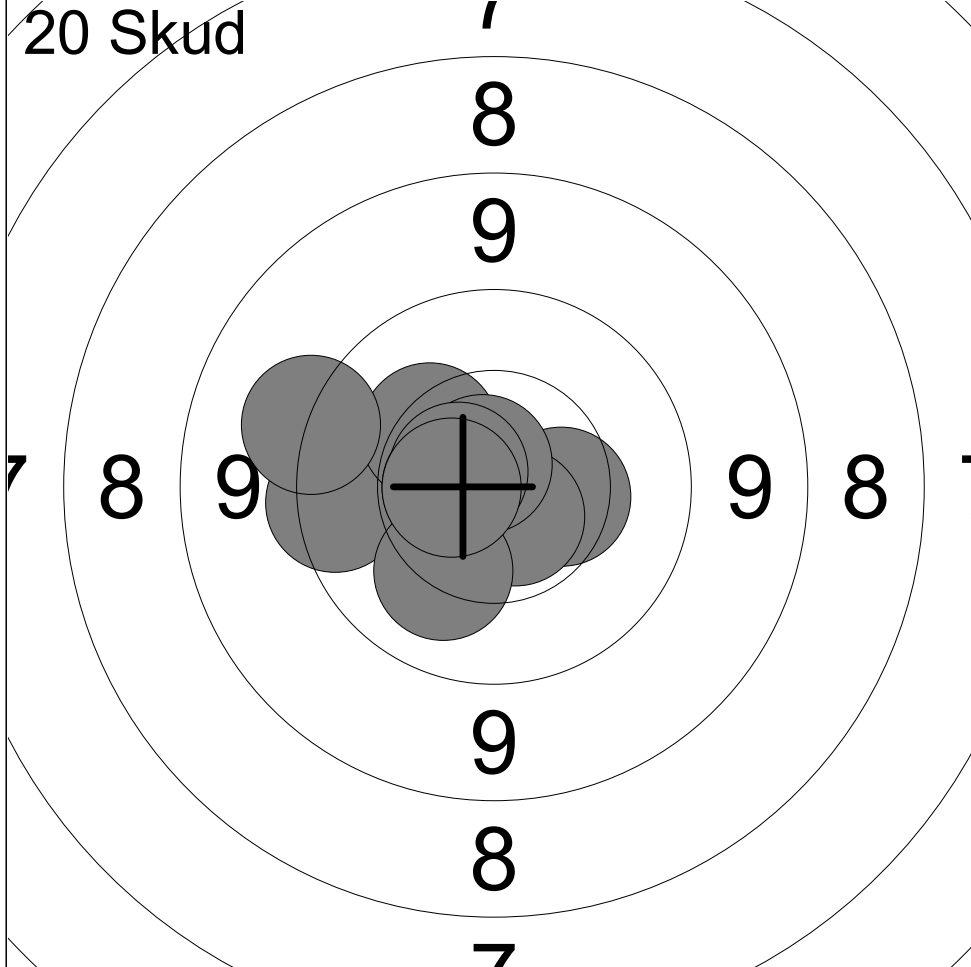

1:	9.7	←
2:	10.3	↗
3:	10.6x	←
4:	10.4	→
5:	9.4	↖
6:	10.7x	↘
7:	10.2	↙
8:	10.8x	↗
9:	10.6x	↖
10:	10.6x	←

Serie	98 (5x)
Total	98 (5x)

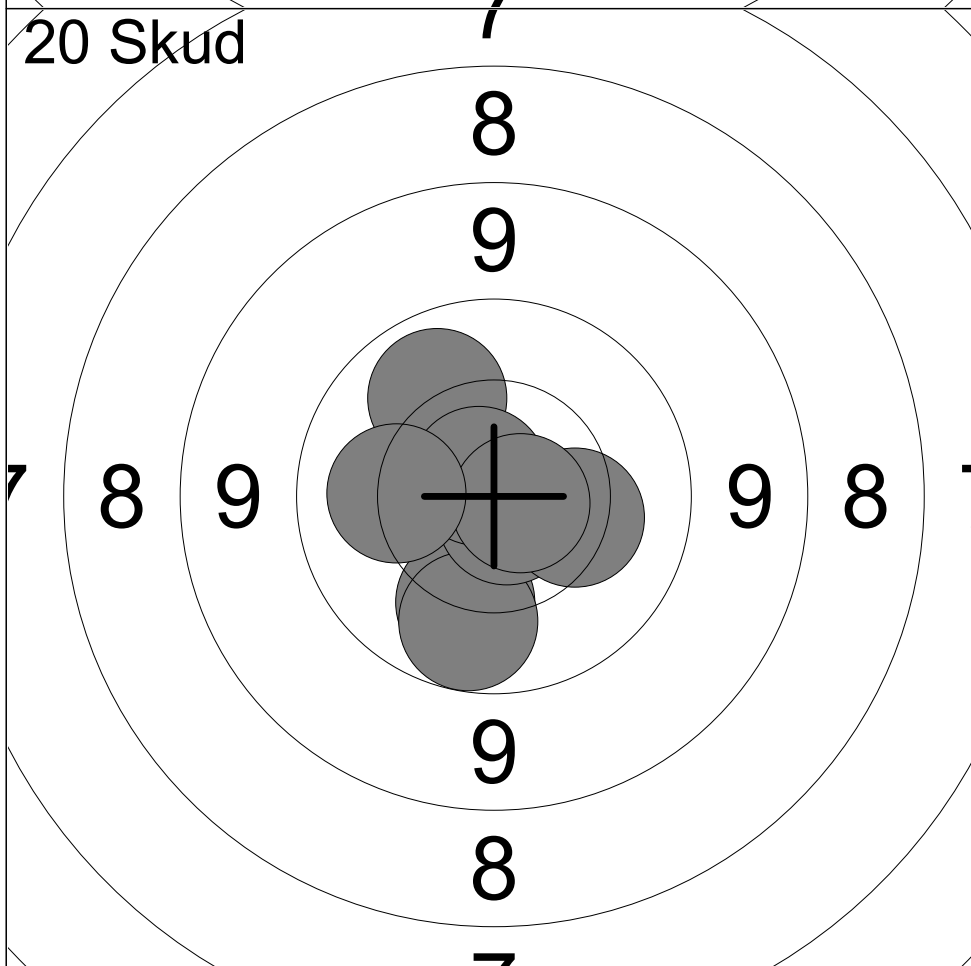

11:	10.4	←
12:	10.1	↗
13:	10.1	↘
14:	10.0	↘
15:	10.9x	→
16:	10.8x	↘
17:	10.3	↘
18:	10.8x	↗
19:	10.7x	↘
20:	10.2	←

Serie	100 (4x)
Total	198 (9x)

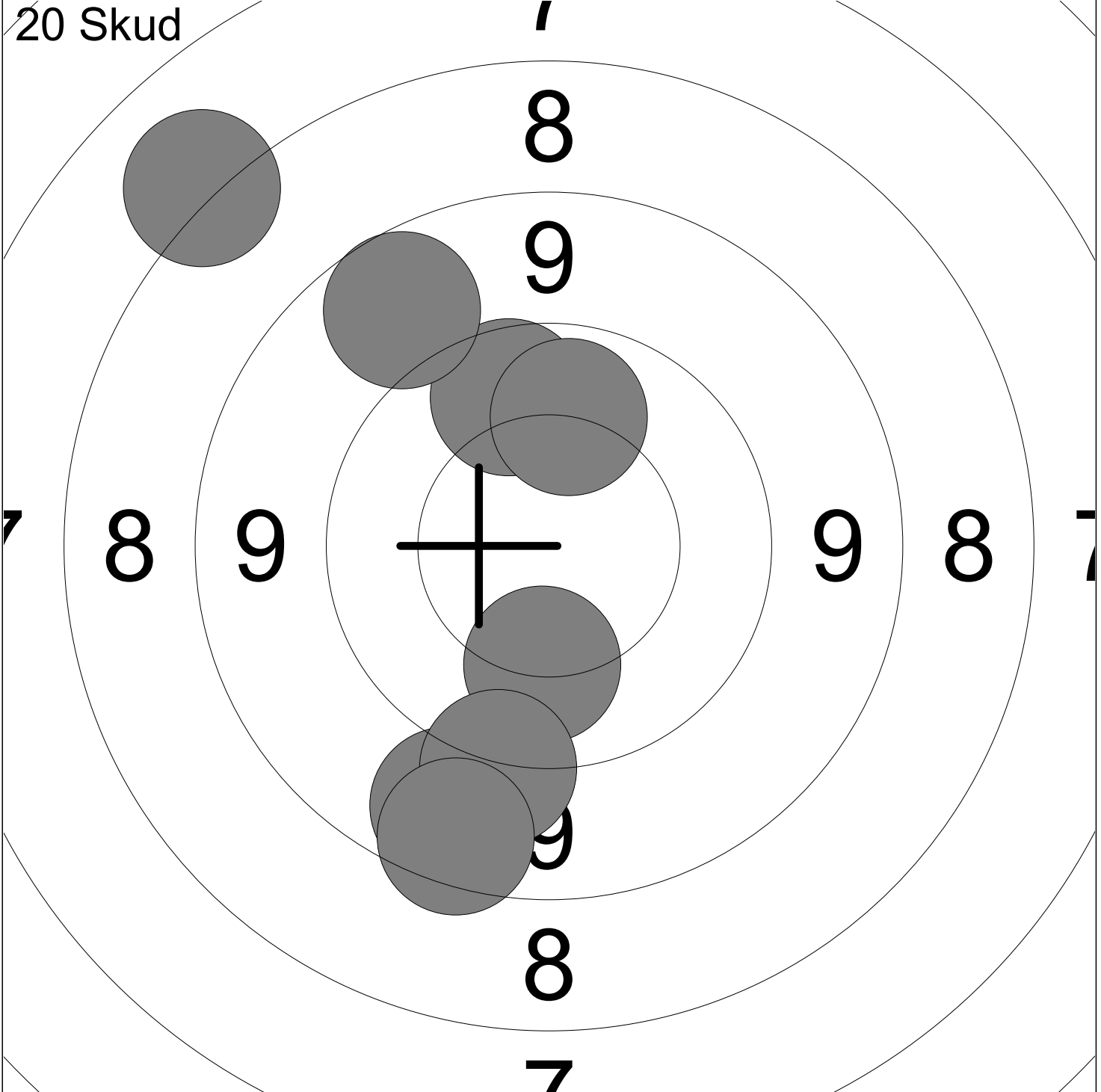

1: 7.2 ↗	6: 8.9 ↗	Serie 69 (0x)
2: 8.9 ↘	7: 8.7 ↘	
3: 9.9 ↗	8: 10.0 ↗	Total 69 (0x)
4: 10.1 ↘		
5: 9.3 ↘		

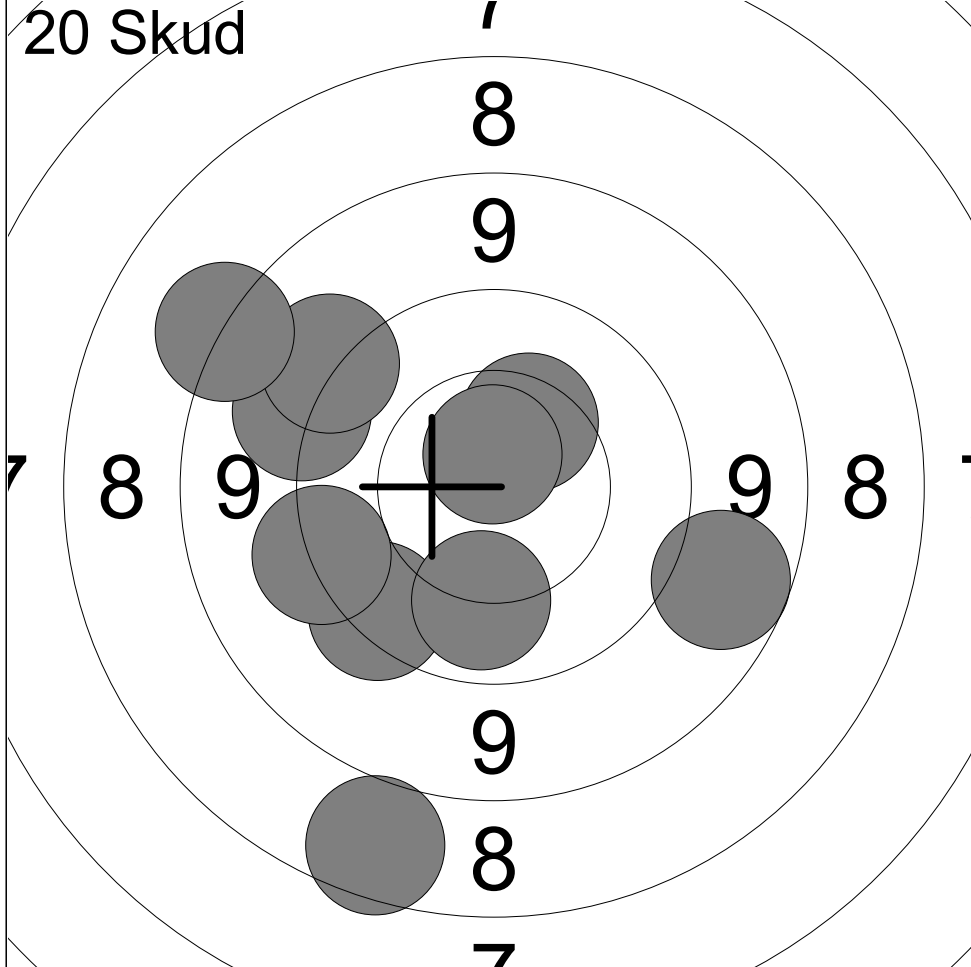

1:	7.8	↘
2:	9.3	↖
3:	10.4	↗
4:	8.9	↘
5:	9.6	↙
6:	9.3	↗
7:	8.4	↖
8:	10.1	↘
9:	9.5	↖
10:	10.7x	↑

Serie	89 (1x)
Total	89 (1x)

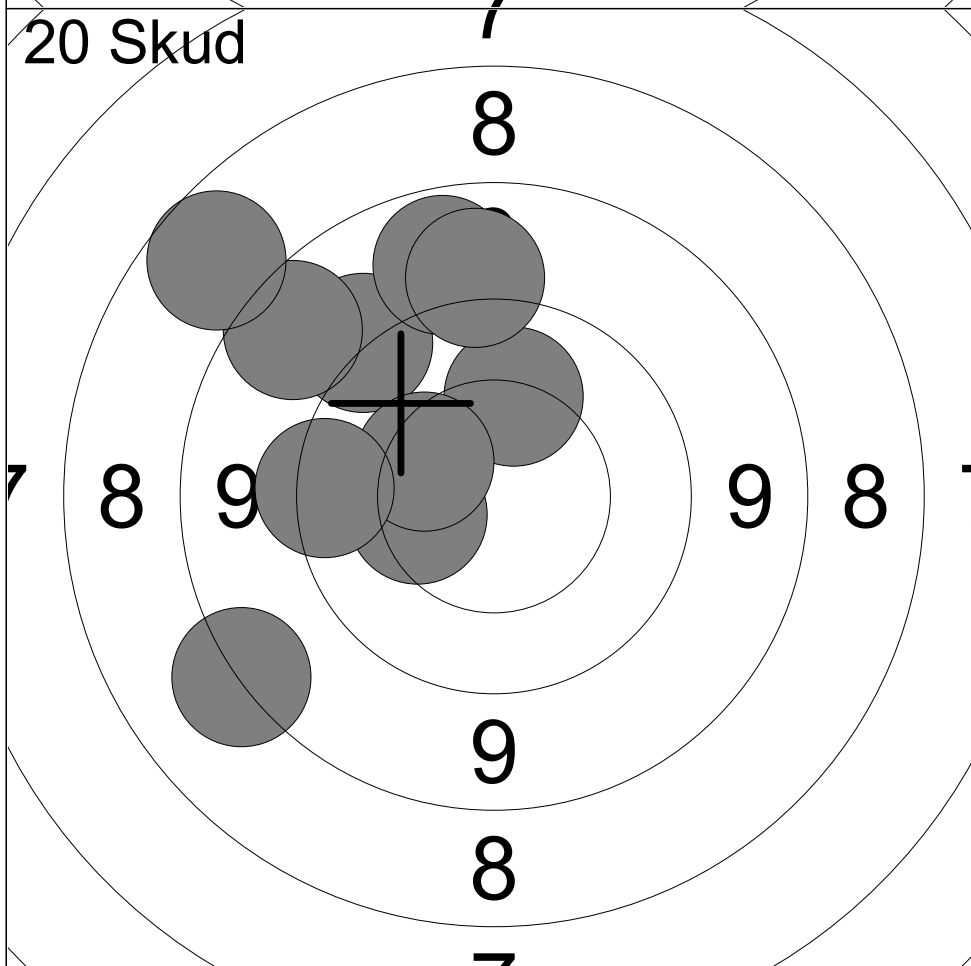

11:	10.3	←
12:	10.2	↑
13:	9.3	↗
14:	8.8	↗
15:	9.0	↑
16:	7.9	↗
17:	10.3	↖
18:	8.4	↙
19:	9.6	←
20:	9.2	↑

Serie	89 (0x)
Total	178 (1x)

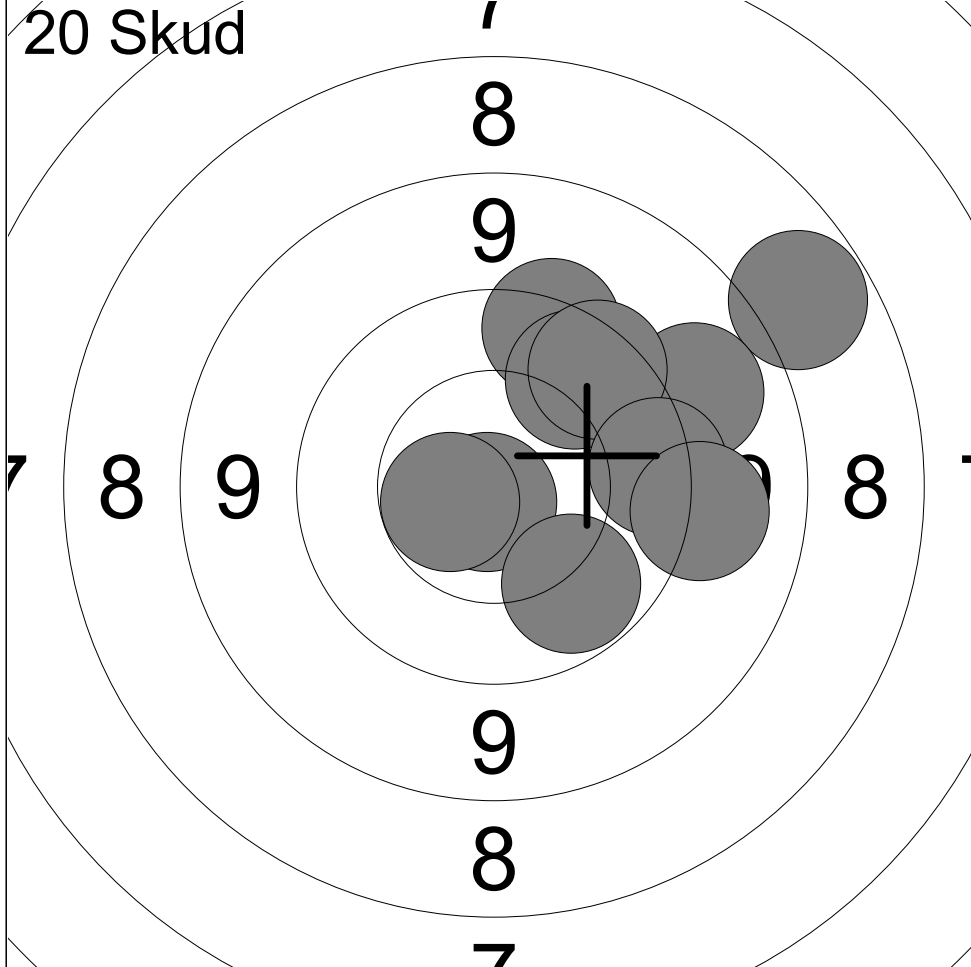

1:	9.6	↗
2:	8.0	↗
3:	9.9	↗
4:	9.1	↗
5:	9.7	↗
6:	10.8x	↘
7:	10.0	↘
8:	10.6x	↖
9:	9.6	→
10:	9.3	→

Serie	92 (2x)
Total	92 (2x)

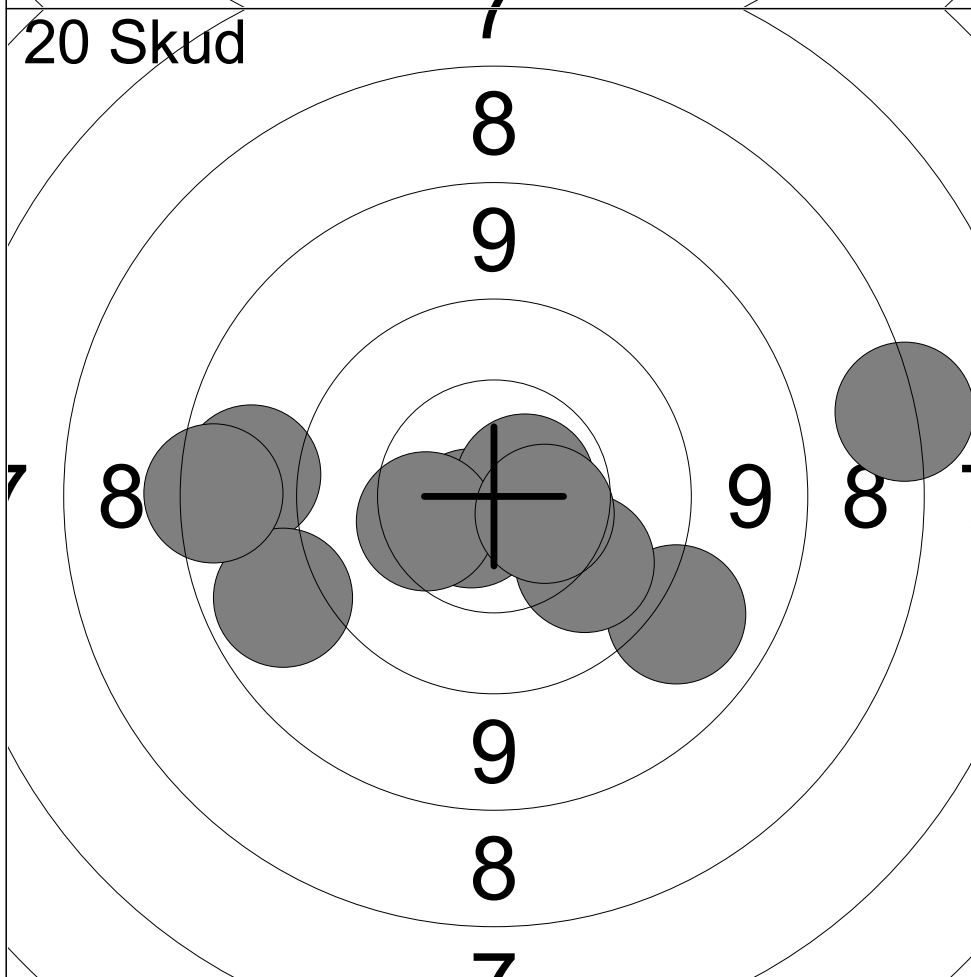

11:	10.7x	↖
12:	10.7x	↗
13:	9.0	↖
14:	10.4	↖
15:	9.2	↘
16:	9.0	↖
17:	10.1	↘
18:	8.6	↖
19:	10.5	↘
20:	7.4	→

Serie	92 (2x)
Total	184 (4x)

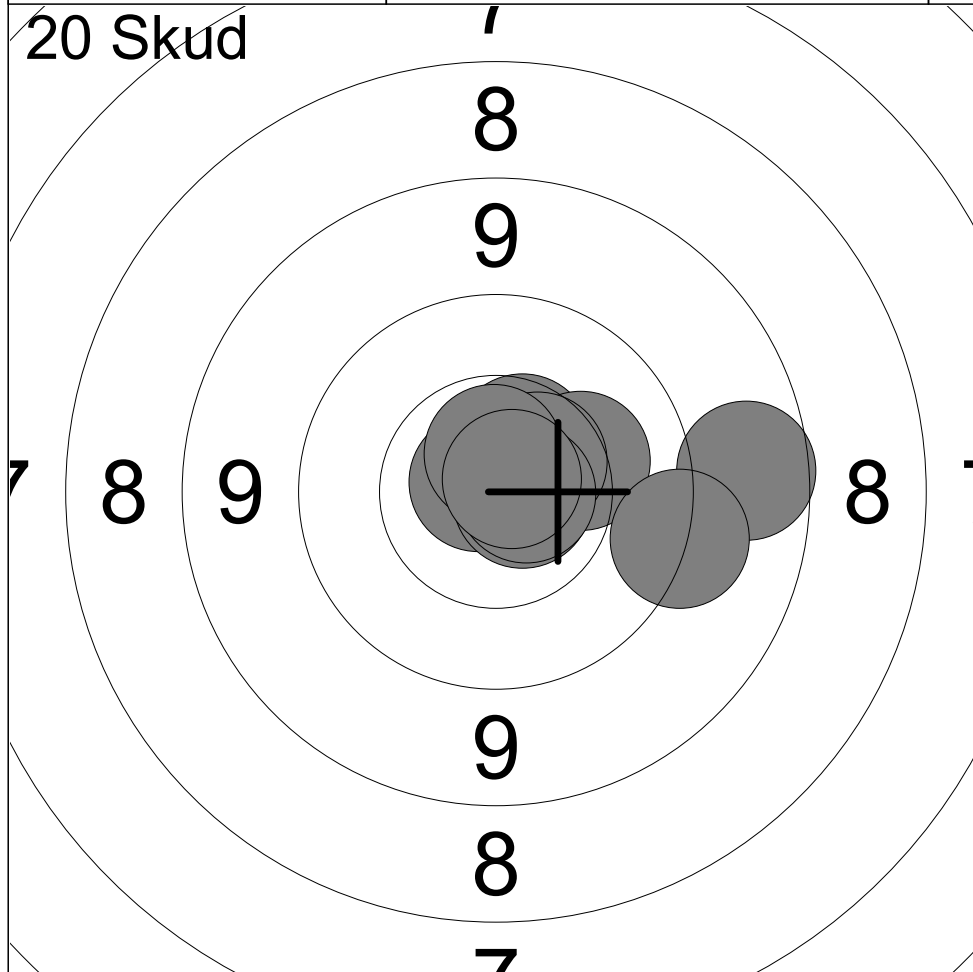

1:	10.5	↗
2:	10.8x	↖
3:	8.9	→
4:	10.7x	↘
5:	10.2	↗
6:	9.4	↘
7:	10.5	↗
8:	10.7x	↑
9:	10.7x	→
10:	10.8x	↗

Serie	97 (5x)
Total	97 (5x)

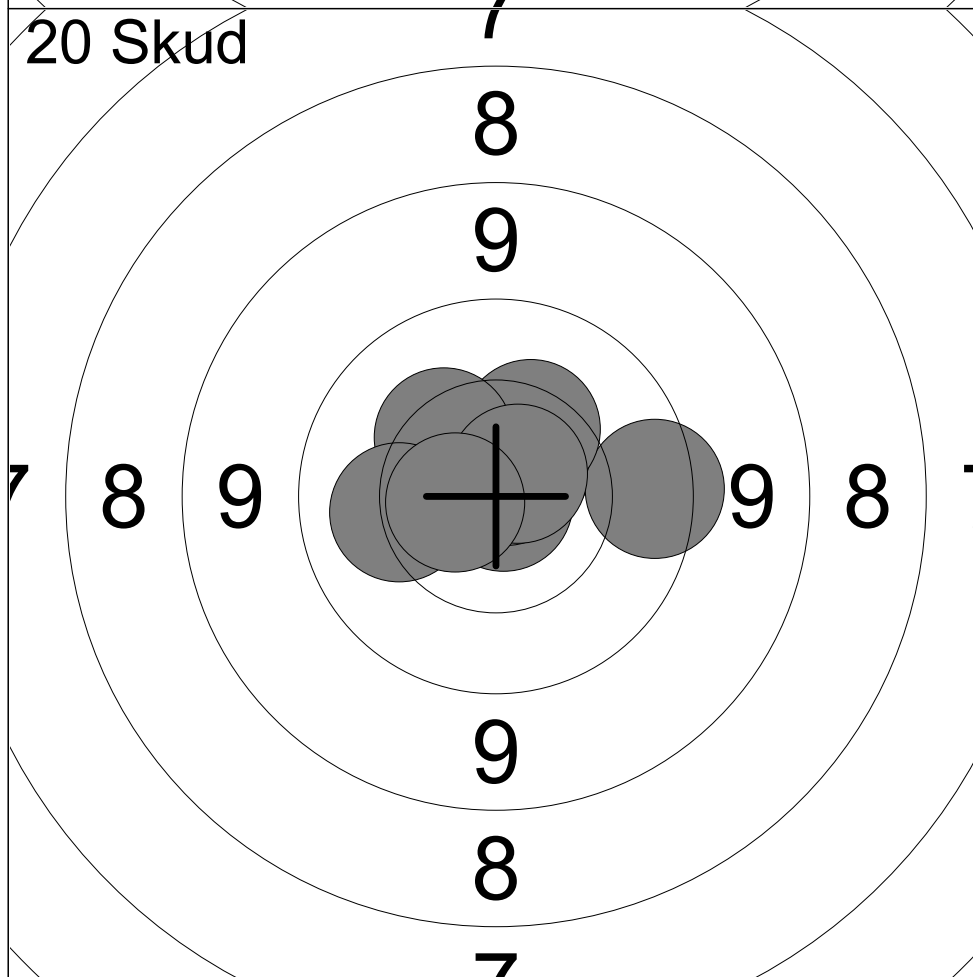

11:	10.6x	↗
12:	9.7	→
13:	10.9x	↘
14:	10.6	↑
15:	10.8x	↗
16:	10.4	↗
17:	10.3	↖
18:	10.2	←
19:	10.7x	↗
20:	10.6x	←

Serie	99 (5x)
Total	196 (10x)

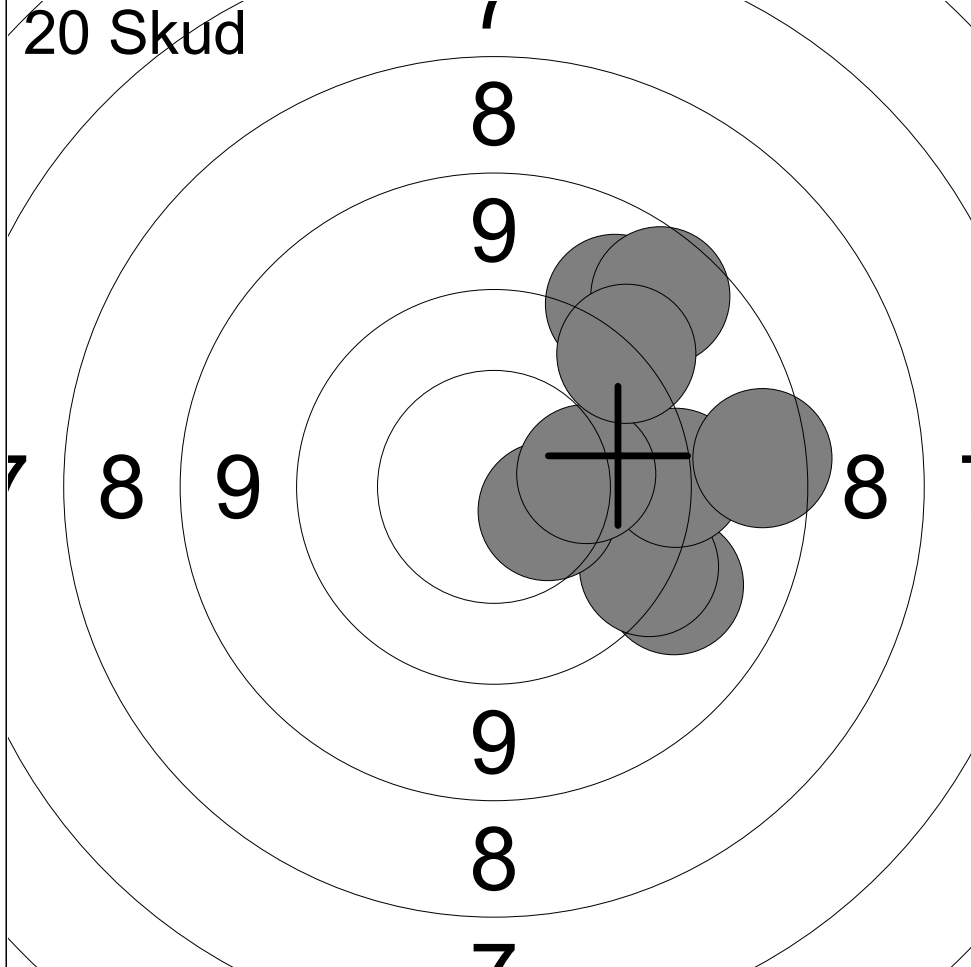

1:	9.3	↘
2:	10.0	→
3:	9.5	↘
4:	9.5	→
5:	8.7	→
6:	9.2	↗
7:	8.9	↗
8:	10.5	↘
9:	10.2	→
10:	9.4	↗

Serie	91 (0x)
Total	91 (0x)

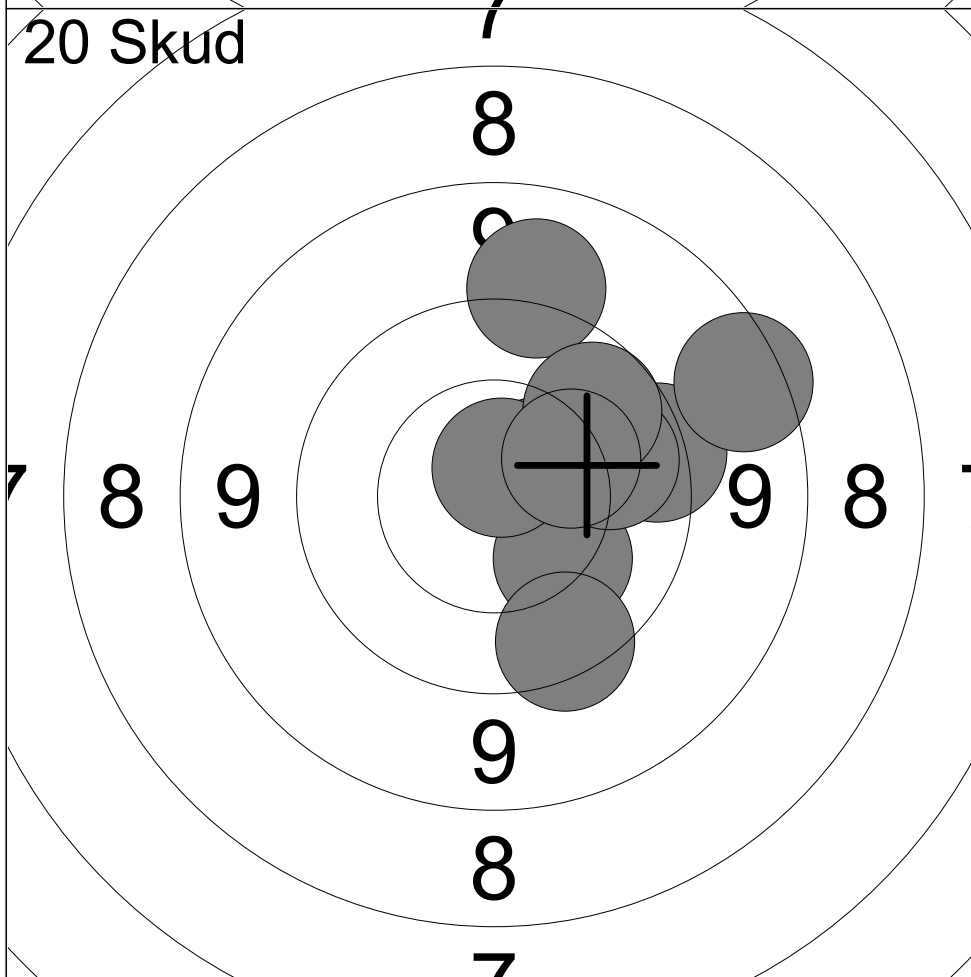

11:	10.5	↗
12:	9.6	→
13:	10.2	↘
14:	10.7x	↗
15:	10.0	→
16:	8.7	↗
17:	9.7	↘
18:	9.2	↗
19:	9.9	↗
20:	10.3	↗

Serie	94 (1x)
Total	185 (1x)

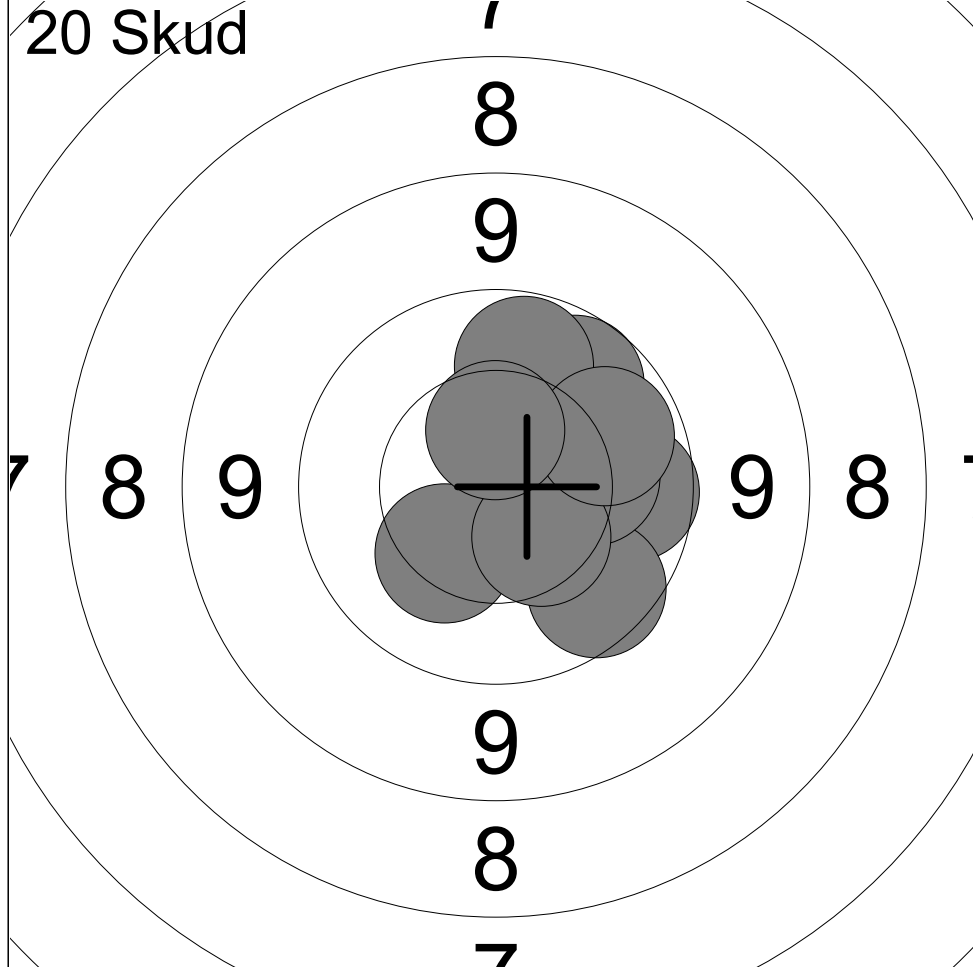

1:	10.7x	↘
2:	10.3	↙
3:	9.9	→
4:	9.8	↘
5:	10.2	→
6:	9.9	↗
7:	10.0	↑
8:	10.4	↘
9:	10.0	↗
10:	10.5	↑

Serie	97 (1x)
Total	97 (1x)

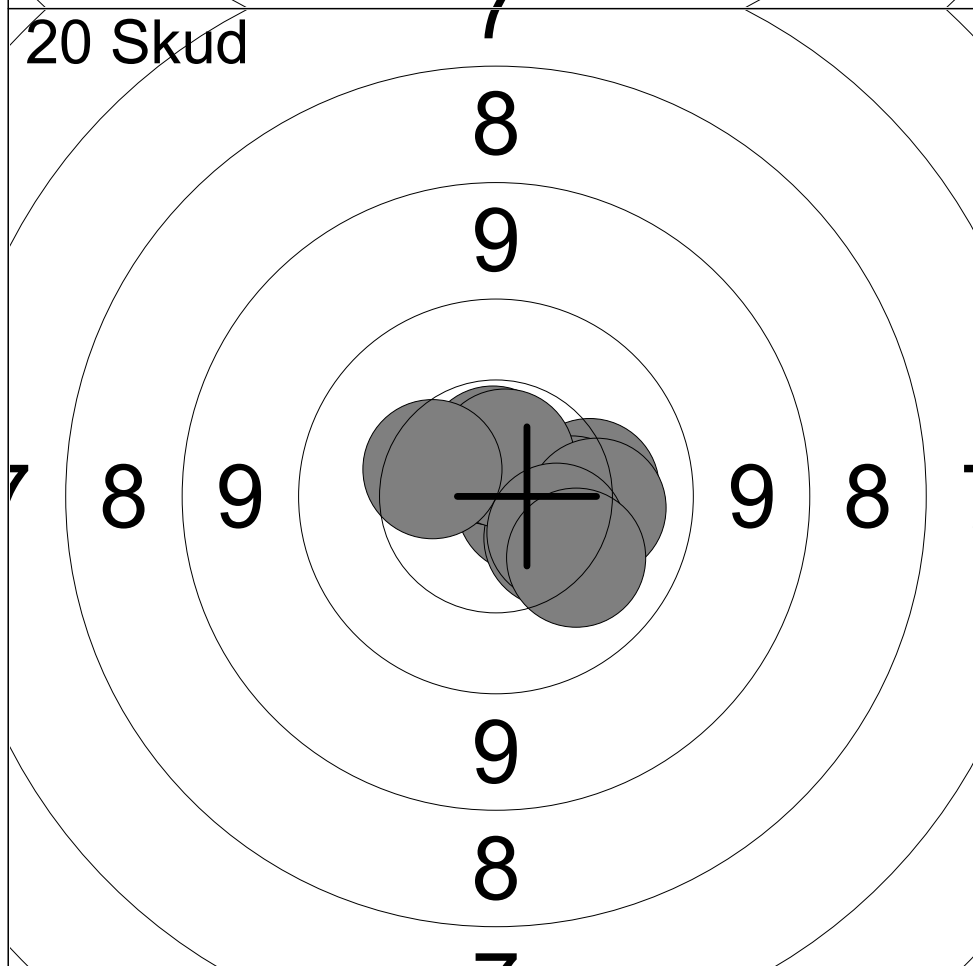

11:	10.7x	→
12:	10.6x	↑
13:	10.2	→
14:	10.4	↘
15:	10.4	→
16:	10.6x	↑
17:	10.2	→
18:	10.4	↘
19:	10.4	↖
20:	10.2	↘

Serie	100 (3x)
Total	197 (4x)

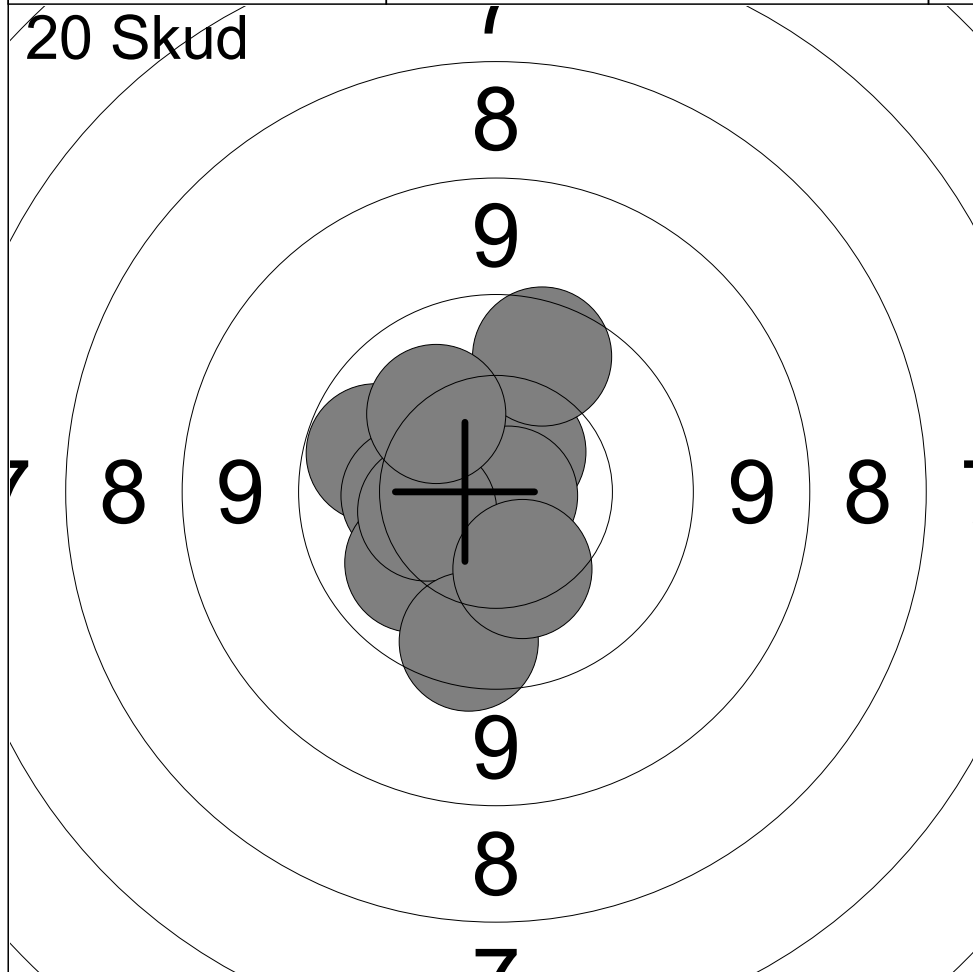

1:	10.0	↖
2:	10.6x	↗
3:	10.3	↖
4:	9.8	↗
5:	10.1	↖
6:	10.9x	↗
7:	10.4	↖
8:	10.2	↗
9:	9.7	↘
10:	10.3	↘

Serie	98 (2x)
Total	98 (2x)

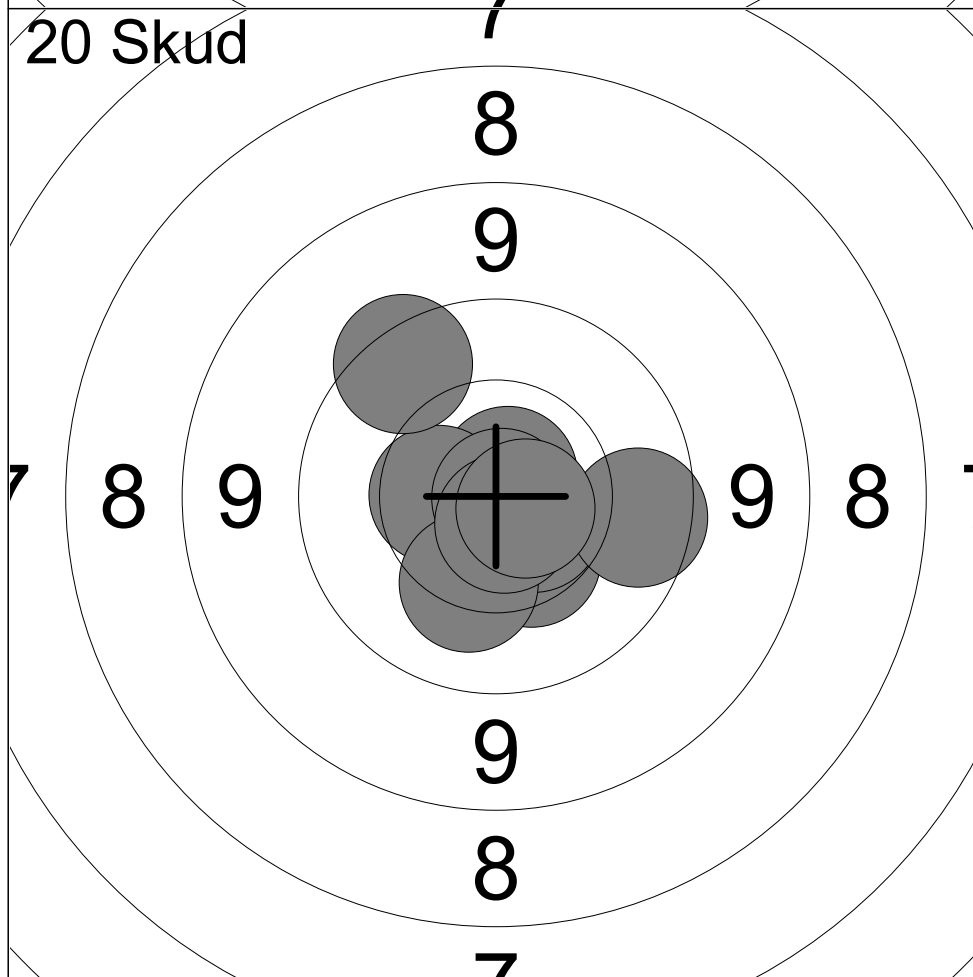

11:	10.8x	↗
12:	10.4	↘
13:	10.5	↖
14:	9.7	↗
15:	10.6x	↘
16:	9.8	↗
17:	10.2	↘
18:	10.9x	↗
19:	10.7x	↘
20:	10.7x	↘

Serie	98 (5x)
Total	196 (7x)

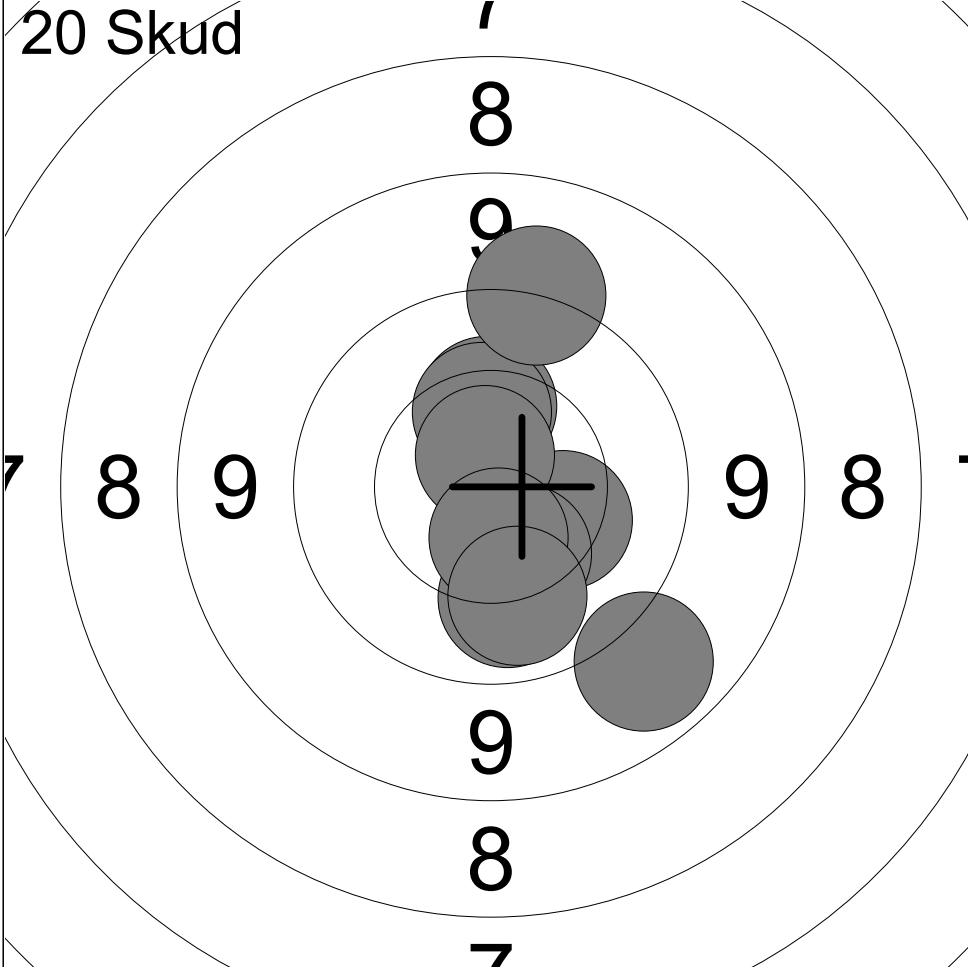

1:	10.3	↑
2:	10.4	↑
3:	10.3	↘
4:	10.7x	↑
5:	10.1	↓
6:	10.4	↘
7:	10.6	↓
8:	9.1	↘
9:	10.1	↓
10:	9.4	↑

Serie	98 (1x)
Total	98 (1x)

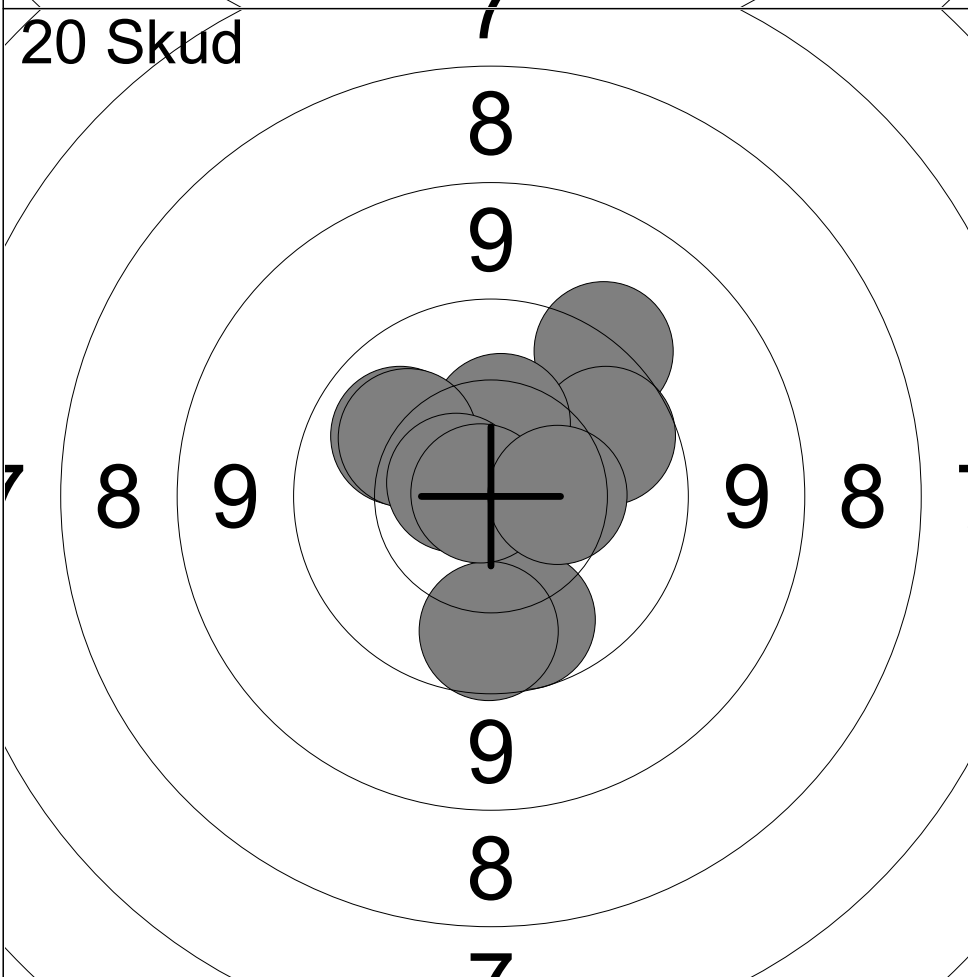

11:	10.1	↖
12:	9.5	↗
13:	9.9	↗
14:	9.9	↓
15:	10.4	↑
16:	10.2	↖
17:	10.7x	↖
18:	9.9	↓
19:	10.9x	↖
20:	10.4	→

Serie	96 (2x)
Total	194 (3x)

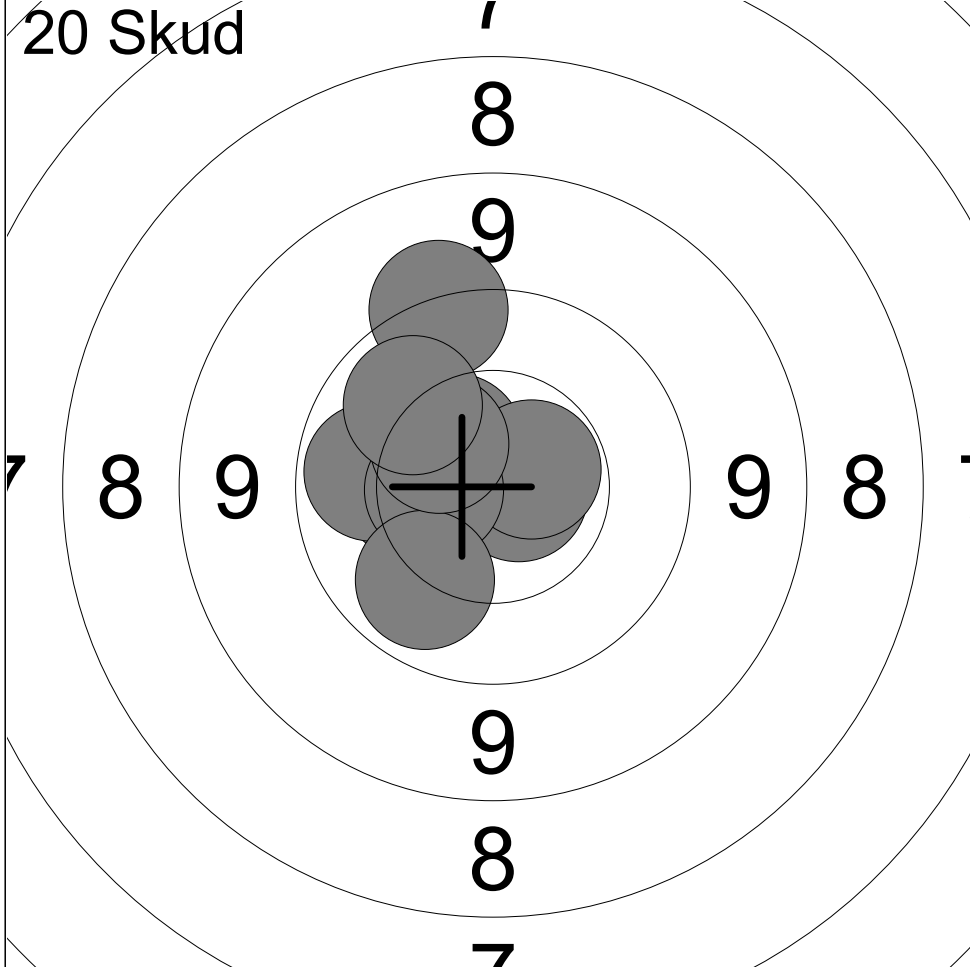

1:	10.5	↗
2:	9.5	↖
3:	10.7x	→
4:	10.6x	↗
5:	10.3	←
6:	10.0	←
7:	10.5	←
8:	10.0	↙
9:	10.4	↖
10:	10.1	↖

Serie	99 (2x)
Total	99 (2x)

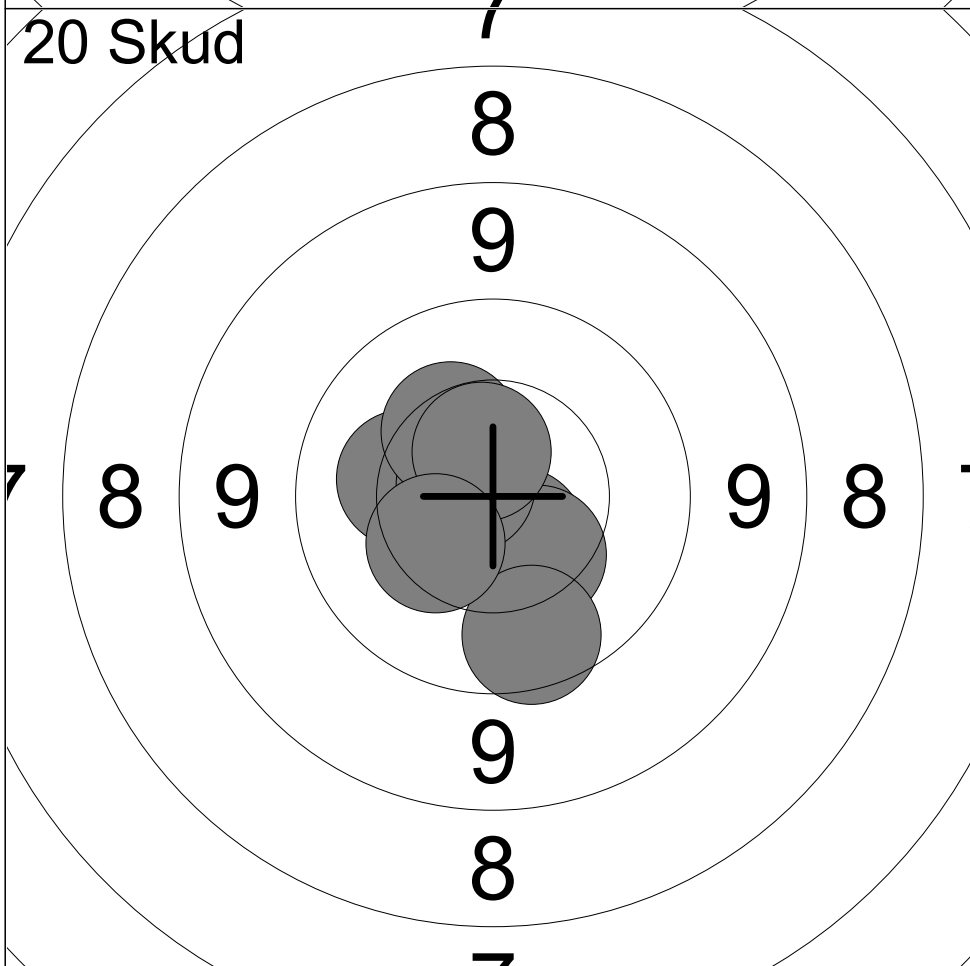

11:	10.3	←
12:	10.6x	↙
13:	10.4	↙
14:	10.6x	↙
15:	10.4	↙
16:	9.8	↙
17:	10.7x	↖
18:	10.3	↖
19:	10.6x	↖
20:	10.4	↙

Serie	99 (4x)
Total	198 (6x)

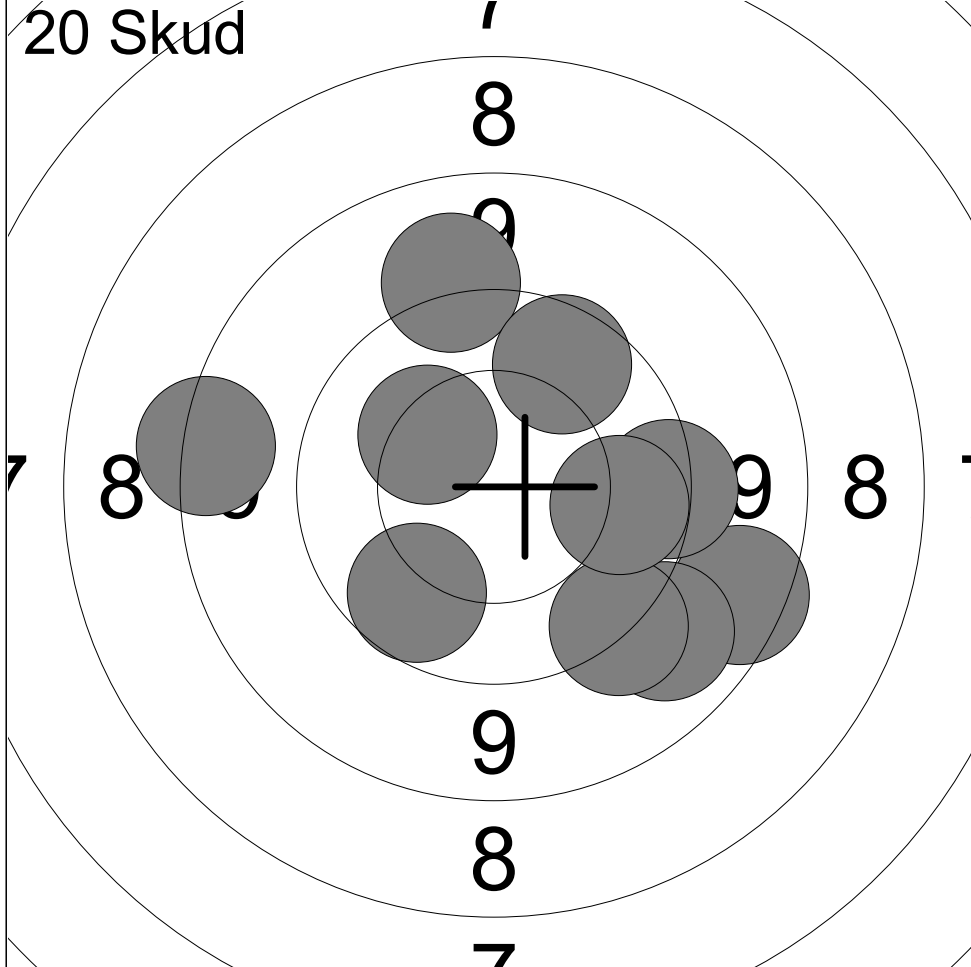

1:	8.7	↘
2:	9.1	↘
3:	9.3	↗
4:	10.3	↗
5:	9.5	→
6:	9.4	↘
7:	10.0	→
8:	9.9	↘
9:	9.8	↗
10:	8.5	←

Serie	90 (0x)
Total	90 (0x)

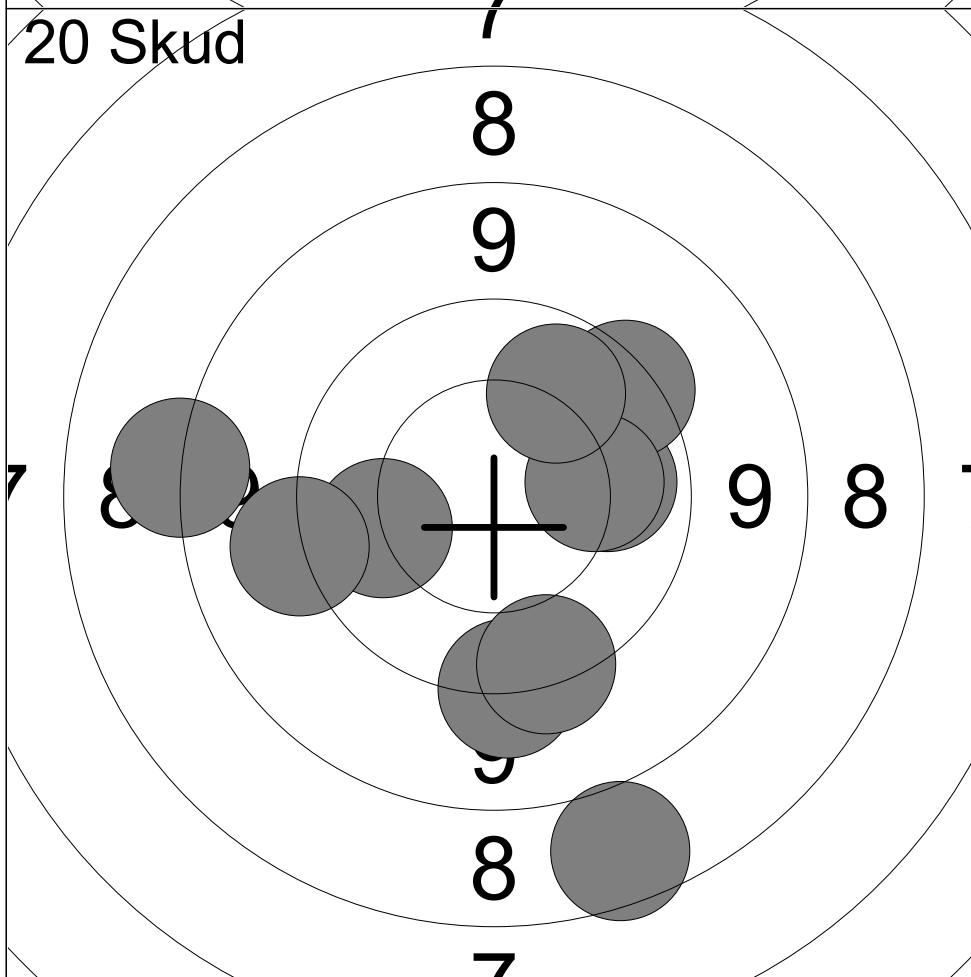

11:	8.3	←
12:	9.4	↓
13:	10.1	→
14:	9.6	↗
15:	9.5	↓
16:	7.8	↓
17:	10.2	→
18:	10.0	←
19:	9.3	←
20:	10.0	↗

Serie	91 (0x)
Total	181 (0x)

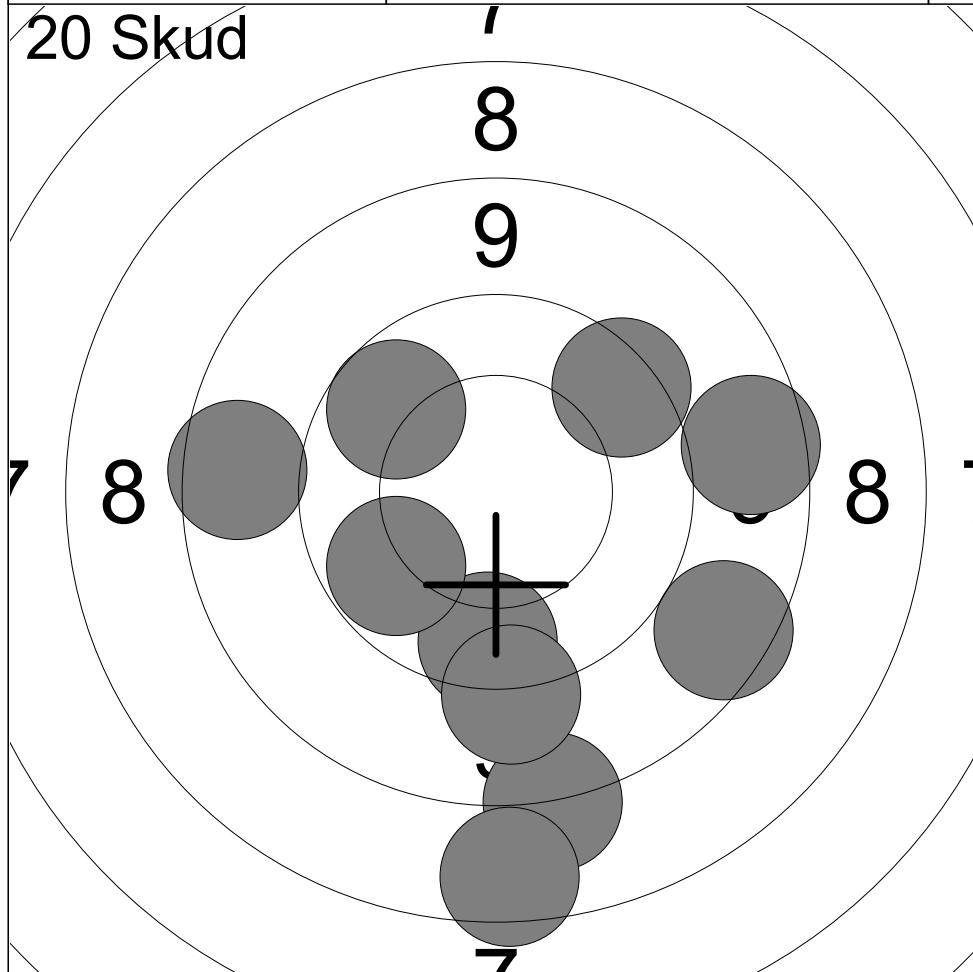

1:	8.3	↓
2:	7.7	↓
3:	9.8	↓
4:	9.9	↖
5:	9.6	↗
6:	8.8	←
7:	10.0	↙
8:	8.8	↘
9:	8.8	→
10:	9.3	↓

Serie	85 (0x)
-------	----------

Total	85 (0x)
-------	----------

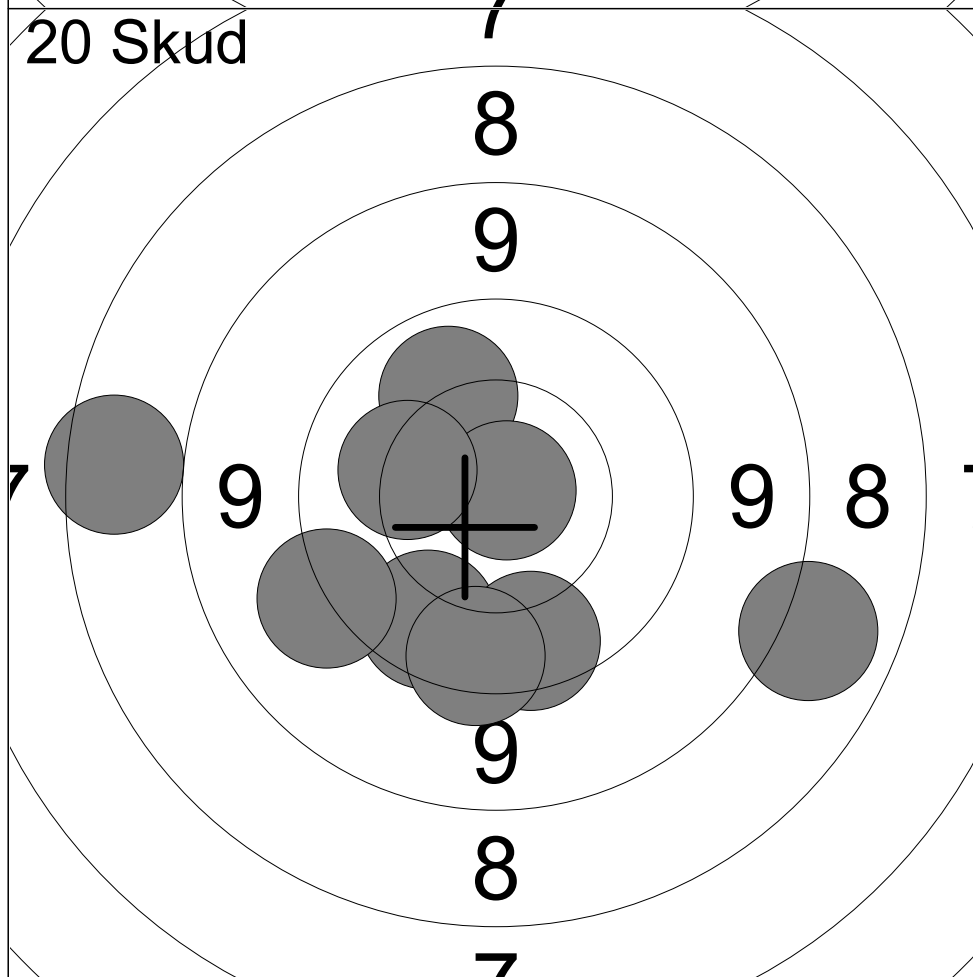

11:	9.8	↙
12:	10.4	↖
13:	7.8	←
14:	10.1	↗
15:	8.1	↘
16:	9.8	↓
17:	9.7	↓
18:	10.9x	↗
19:	9.4	↙
20:	10.2	↖

Serie	91 (1x)
-------	----------

Total	176 (1x)
-------	-----------

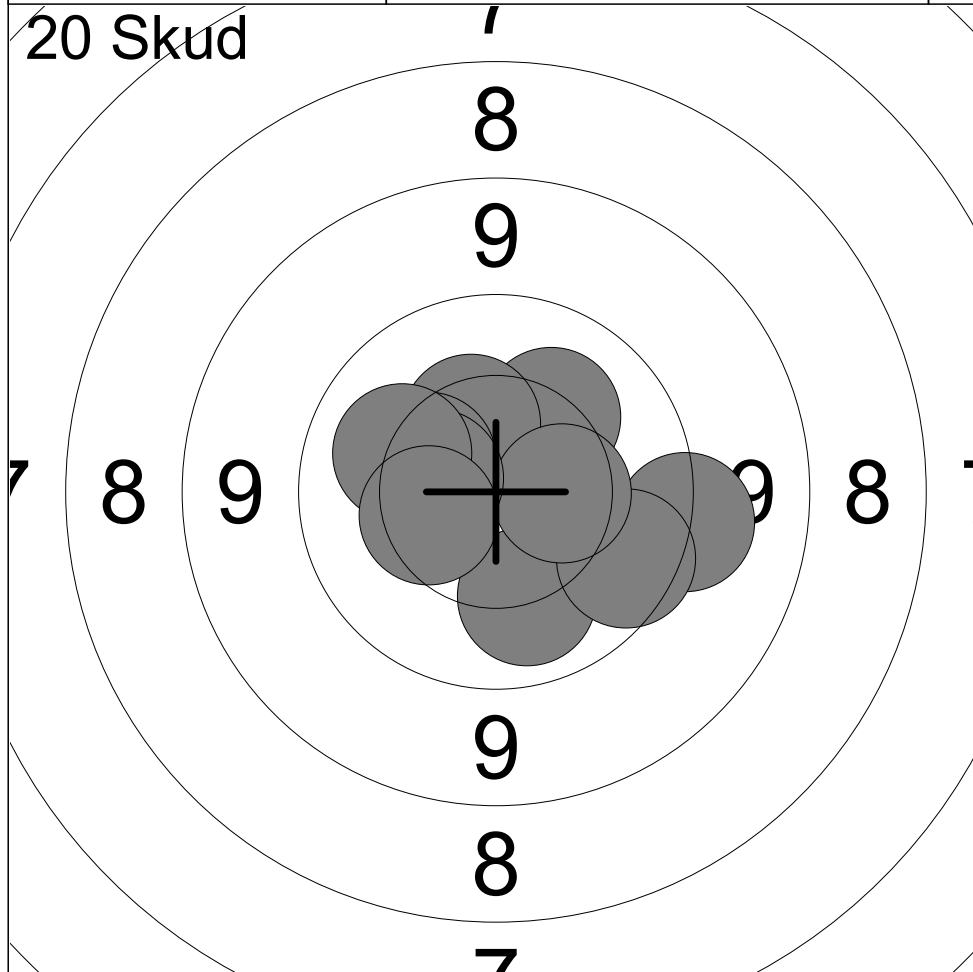

1:	10.2	↗
2:	10.1	↘
3:	9.4	→
4:	10.4	↗
5:	9.8	↘
6:	10.4	→
7:	10.4	↗
8:	10.5	↖
9:	10.2	↖
10:	10.4	↖

Serie	98 (0x)
Total	98 (0x)

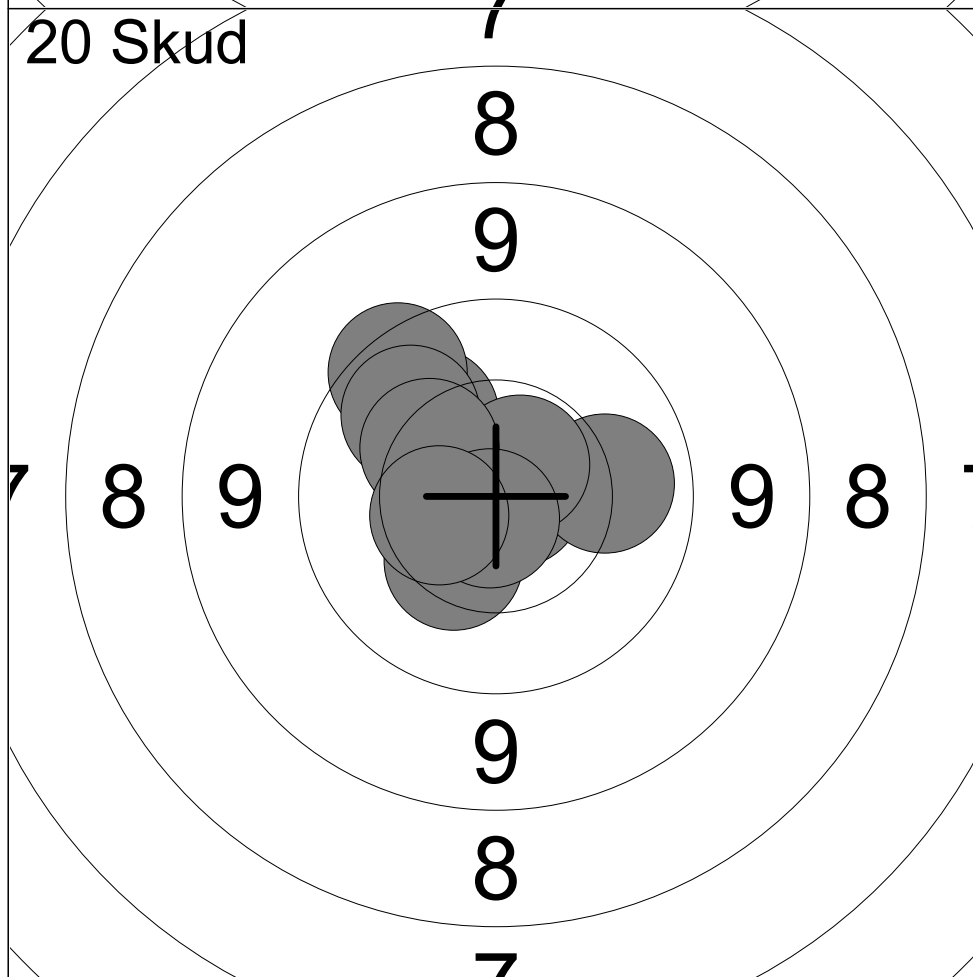

11:	10.8x	→
12:	10.1	↗
13:	10.1	→
14:	9.7	↗
15:	10.0	↗
16:	10.6x	↗
17:	10.3	↗
18:	10.3	↘
19:	10.8x	↘
20:	10.5	↖

Serie	99 (3x)
Total	197 (3x)