

Hold <b>2</b>	Skive <b>1</b>	<b>Bjoern Thomsen</b>	
50m		Ganløse Skytteforening	Å1
09.08.2025		EM 2025	Hanebjerg Skyttecenter
Kommentar		Signatur	

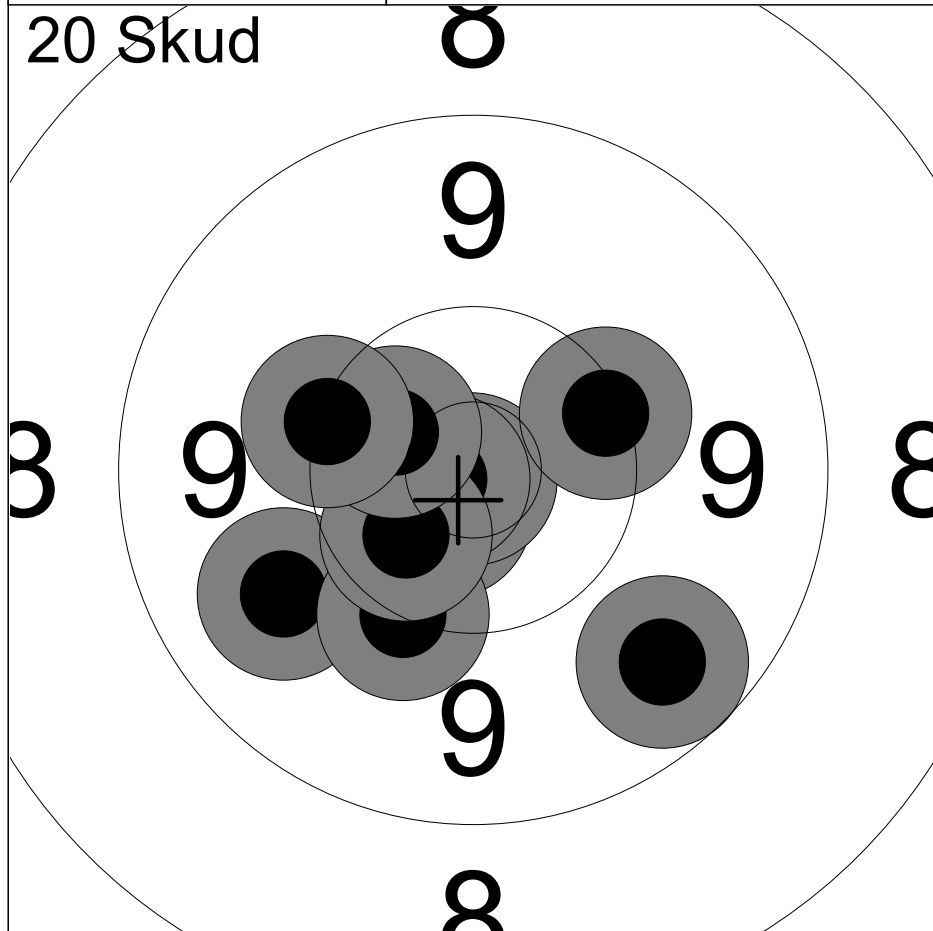

1:	10.7x	↙
2:	9.6	↘
3:	9.8	↙
4:	10.2	↙
5:	10.9x	↙
6:	10.8x	←
7:	10.5x	↙
8:	10.5x	↖
9:	10.3	↗
10:	10.2	↖
Serie		98 ( 5x)
Total		98 ( 5x)

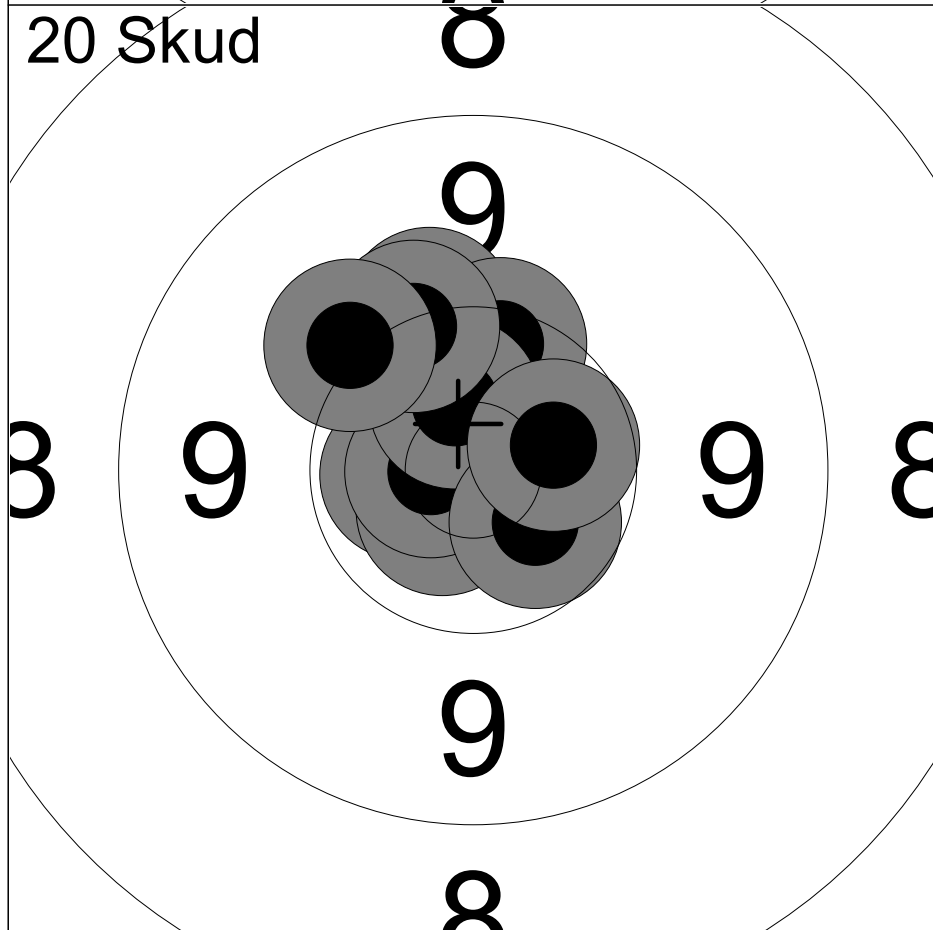

11:	10.6x	←
12:	10.7x	↙
13:	10.2	↑
14:	10.7x	←
15:	10.3	↑
16:	10.6x	↑
17:	10.6x	↘
18:	10.5x	↗
19:	10.2	↑
20:	10.1	↖
Serie		100 ( 6x)
Total		198 (11x)

Hold <b>2</b>	Skive <b>12</b>	<b>Linus Zvirblis</b>		
50m	Bløvstrød SG&I - Skytteafd.		ST3	
09.08.2025	EM 2025	Hanebjerg Skyttecenter		
Kommentar	Signatur			

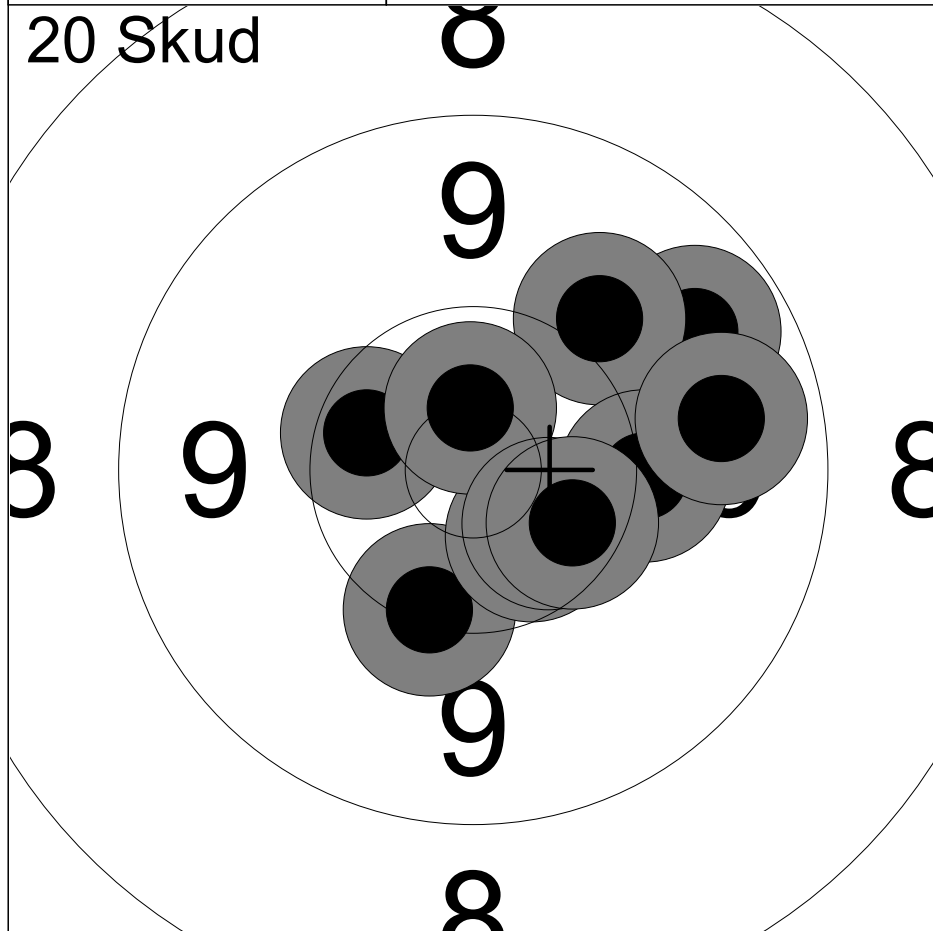

1:	9.7	↗
2:	10.0	↗
3:	10.4	↖
4:	10.2	↘
5:	10.5x	↘
6:	10.1	→
7:	10.6x	↑
8:	9.7	→
9:	10.5x	↘
10:	10.4	↘
Serie		98 ( 3x)
Total		98 ( 3x)

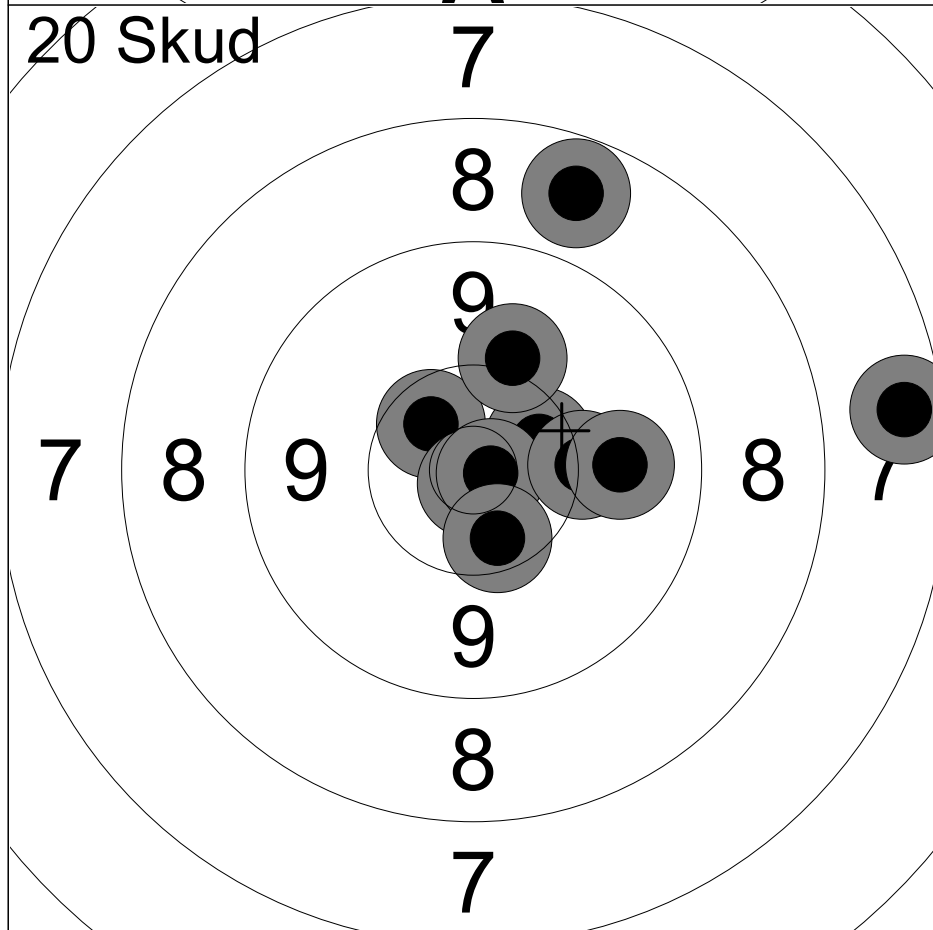

11:	10.5x	↗
12:	10.8x	↘
13:	10.4	↗
14:	10.8x	→
15:	10.1	↗
16:	10.1	→
17:	7.5	→
18:	10.4	↘
19:	8.6	↗
20:	9.8	→
Serie		94 ( 3x)
Total		192 ( 6x)

Hold <b>3</b>	Skive <b>1</b>	<b>Stefan Misfeldt Kvist-Andersen</b>	
50m		Ganløse Skytteforening	Å1
09.08.2025		EM 2025	Hanebjerg Skyttecenter
Kommentar		Signatur	

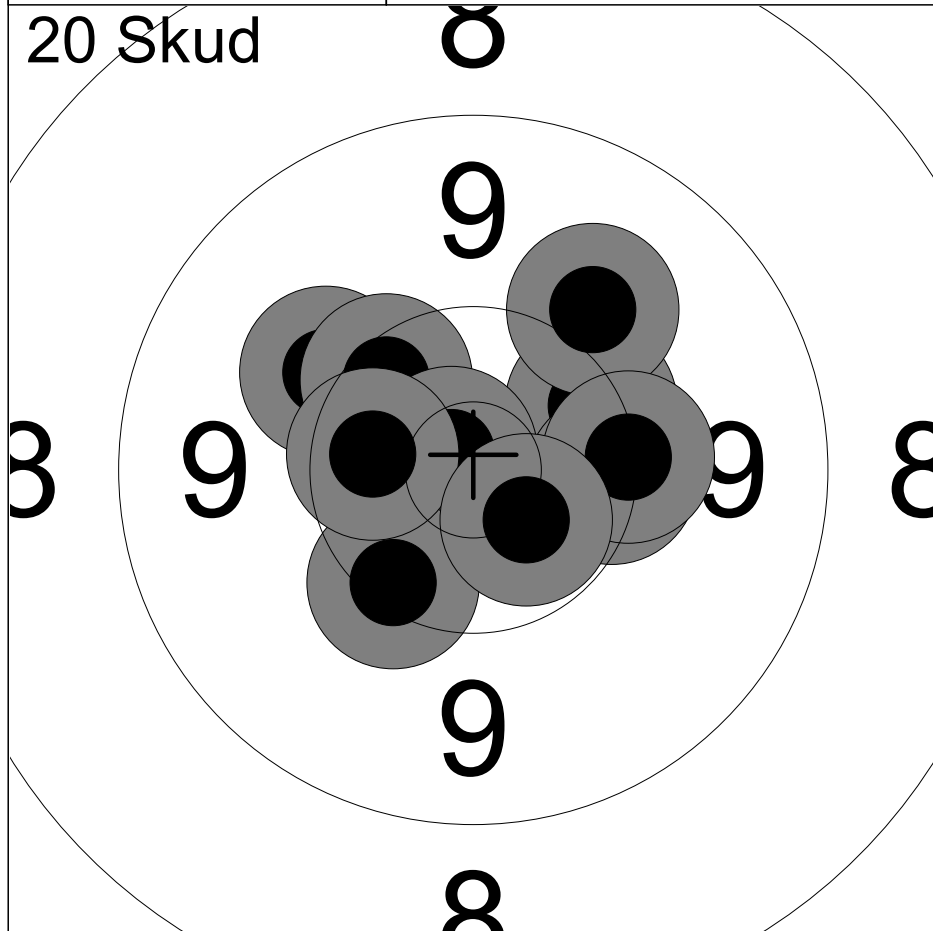

1:	10.1	↖
2:	10.3	↖
3:	10.3	↗
4:	10.8x	↖
5:	10.3	→
6:	10.0	↗
7:	10.3	↙
8:	10.5x	←
9:	10.2	→
10:	10.6x	↘
Serie		100 ( 3x)
Total		100 ( 3x)

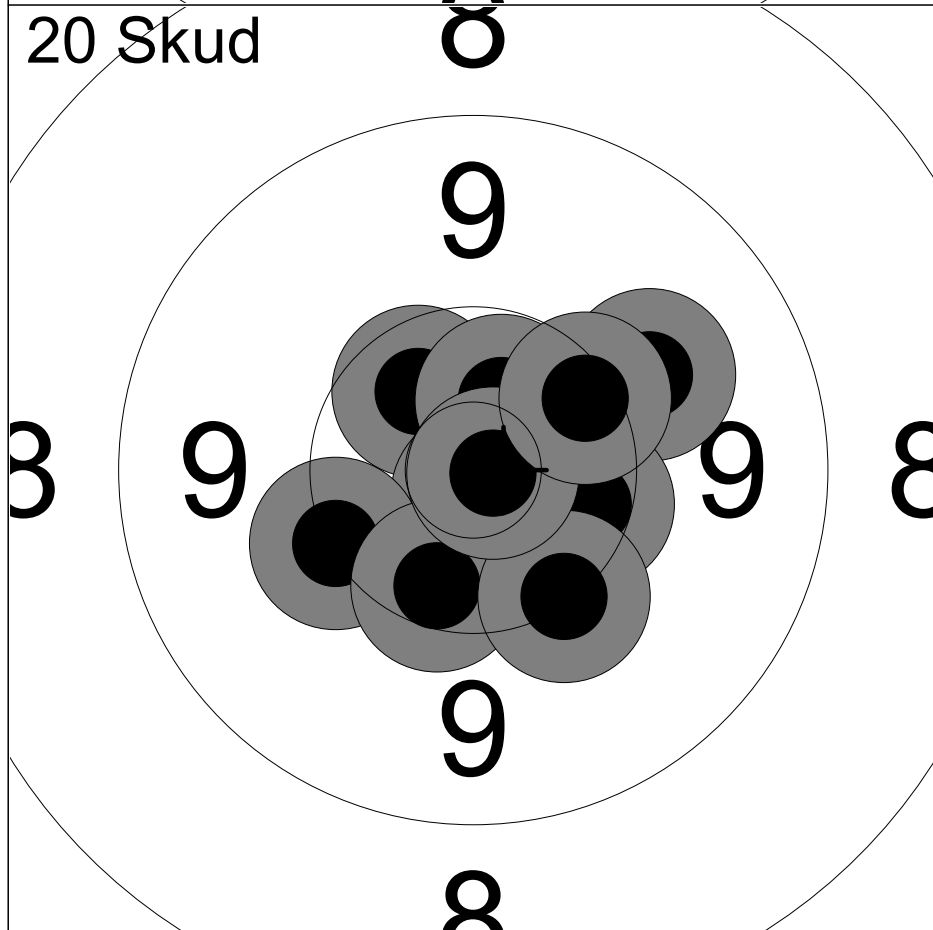

11:	10.5x	↖
12:	10.8x	↘
13:	10.2	↙
14:	10.0	↗
15:	10.4	→
16:	10.6x	↖
17:	10.4	↙
18:	10.2	↘
19:	10.9x	→
20:	10.3	↗
Serie		100 ( 4x)
Total		200 ( 7x)

Hold <b>3</b>	Skive <b>2</b>	<b>Simone Misfeldt Kvist-Andersen</b>	
50m	Frederikssund Skytteforening, I	A1	
09.08.2025	EM 2025	Hanebjerg Skyttecenter	
Kommentar	Signatur		



1:	10.5x	↙
2:	10.8x	←
3:	10.6x	↑
4:	10.7x	↘
5:	10.5x	←
6:	10.6x	↗
7:	10.8x	↗
8:	10.3	↗
9:	10.8x	↗
10:	10.6x	←
Serie		100 ( 9x)
Total		100 ( 9x)

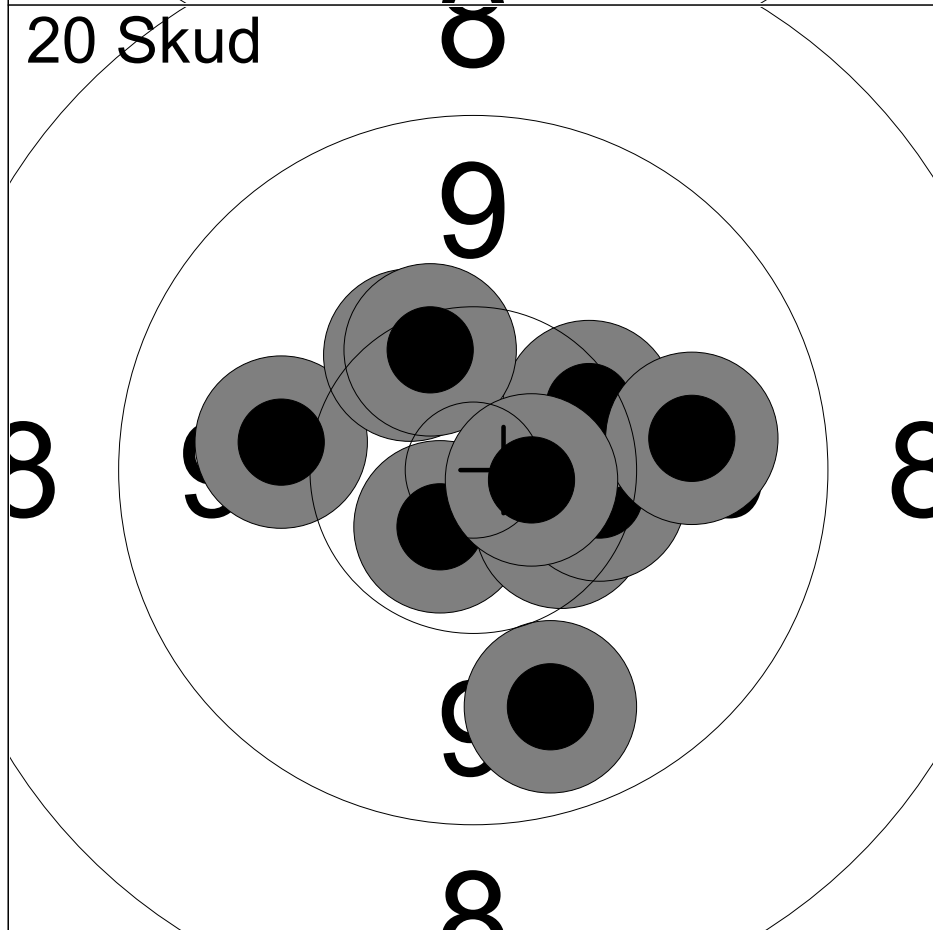

11:	10.6x	↙
12:	10.0	←
13:	10.5x	↘
14:	10.3	→
15:	10.3	↗
16:	10.3	↗
17:	9.7	↘
18:	10.3	↗
19:	9.9	→
20:	10.7x	→
Serie		98 ( 3x)
Total		198 (12x)

Hold <b>3</b>	Skive <b>12</b>	<b>Linus Zvirblis</b>	
50m	Blovstrød SG&I - Skytteafd.	MST3	
09.08.2025	EM 2025	Hanebjerg Skyttecenter	
Kommentar	Signatur		

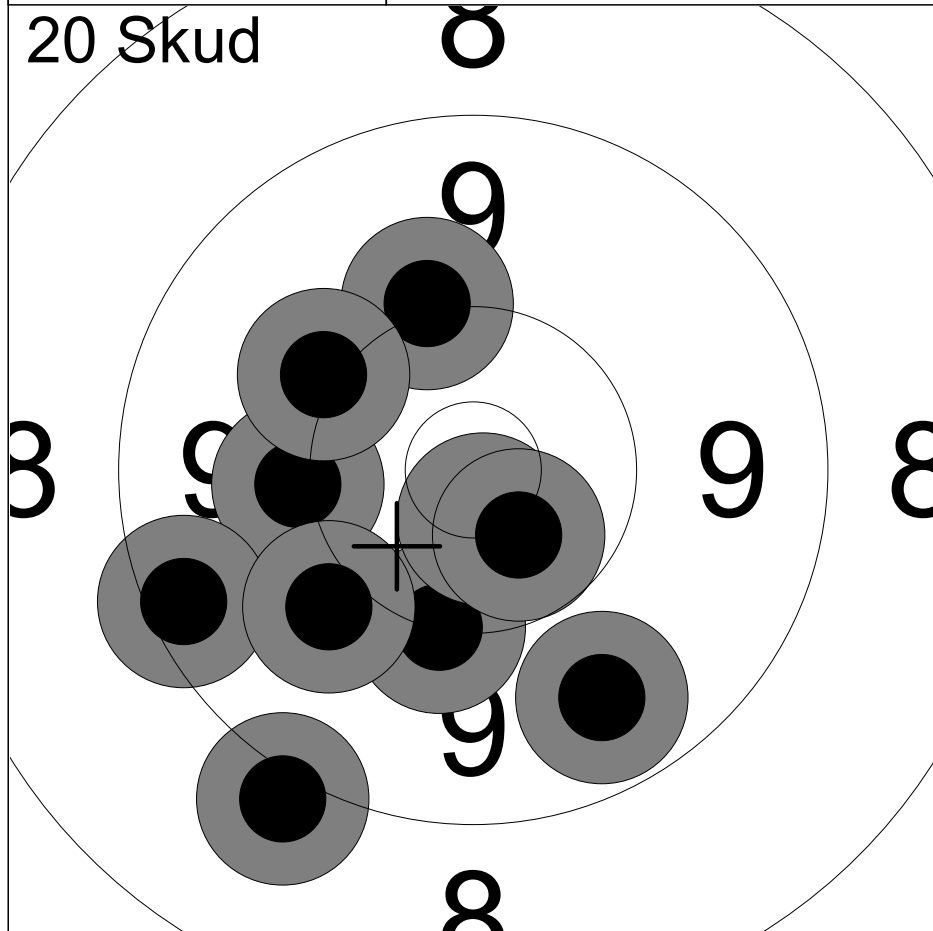

1:	10.2	↓
2:	10.1	←
3:	9.4	↙
4:	9.7	↘
5:	9.0	↘
6:	10.1	↑
7:	10.1	↖
8:	10.0	↙
9:	10.7x	↓
10:	10.6x	↘
Serie		97 ( 2x)
Total		97 ( 2x)

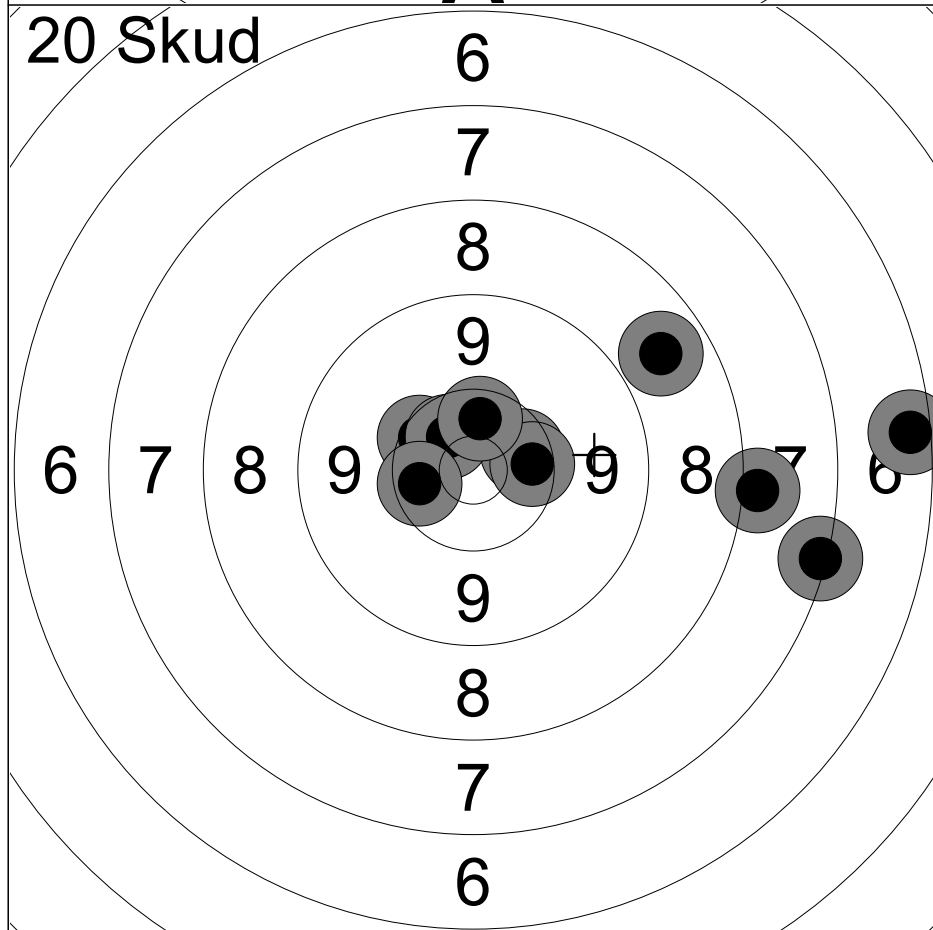

11:	10.3	↖
12:	10.4x	↗
13:	10.4	→
14:	10.5x	↖
15:	10.4x	↑
16:	10.4	←
17:	8.7	↗
18:	8.0	→
19:	7.2	→
20:	6.4	→
Serie		89 ( 3x)
Total		186 ( 5x)

Hold <b>4</b>	Skive <b>1</b>	<b>Bjoern Thomsen</b>	
50m		Ganløse Skytteforening	MÅ1
09.08.2025		EM 2025	Hanebjerg Skyttecenter
Kommentar		Signatur	

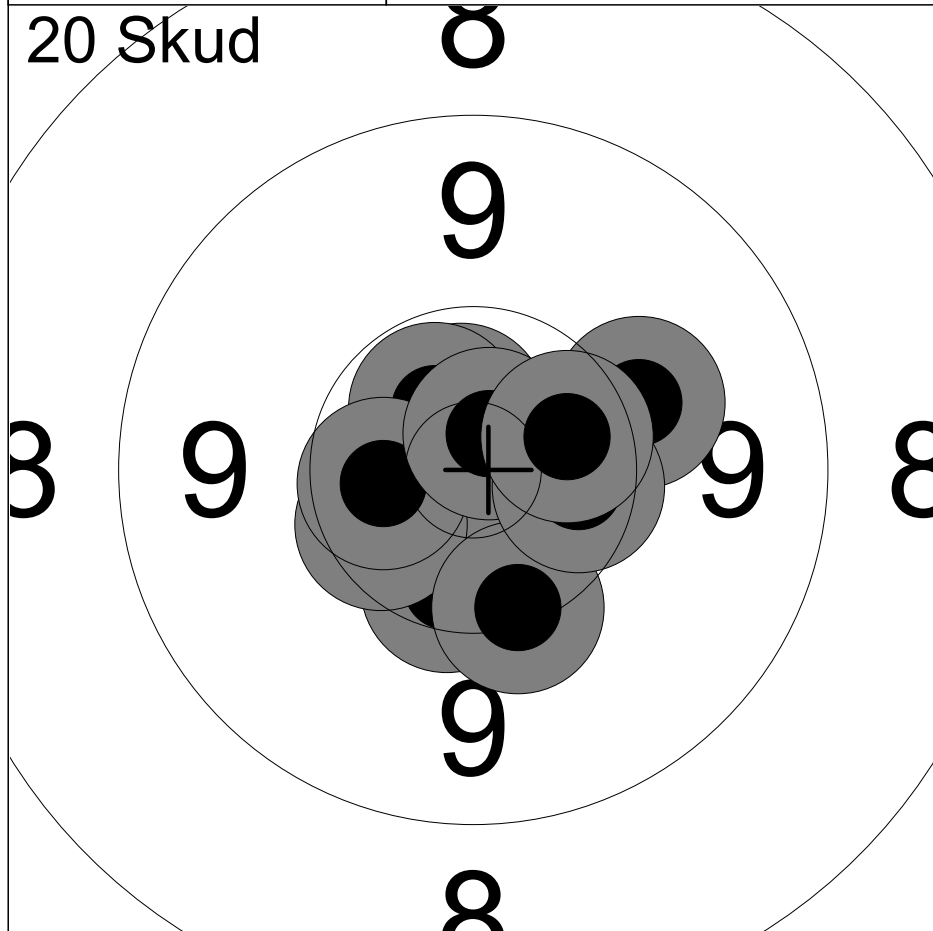

1:	10.4	↓
2:	10.7x	↑
3:	10.4x	↙
4:	10.2	↓
5:	10.6x	↑
6:	10.5x	←
7:	10.1	↗
8:	10.8x	↑
9:	10.4x	→
10:	10.5x	↗
Serie		100 ( 7x)
Total		100 ( 7x)

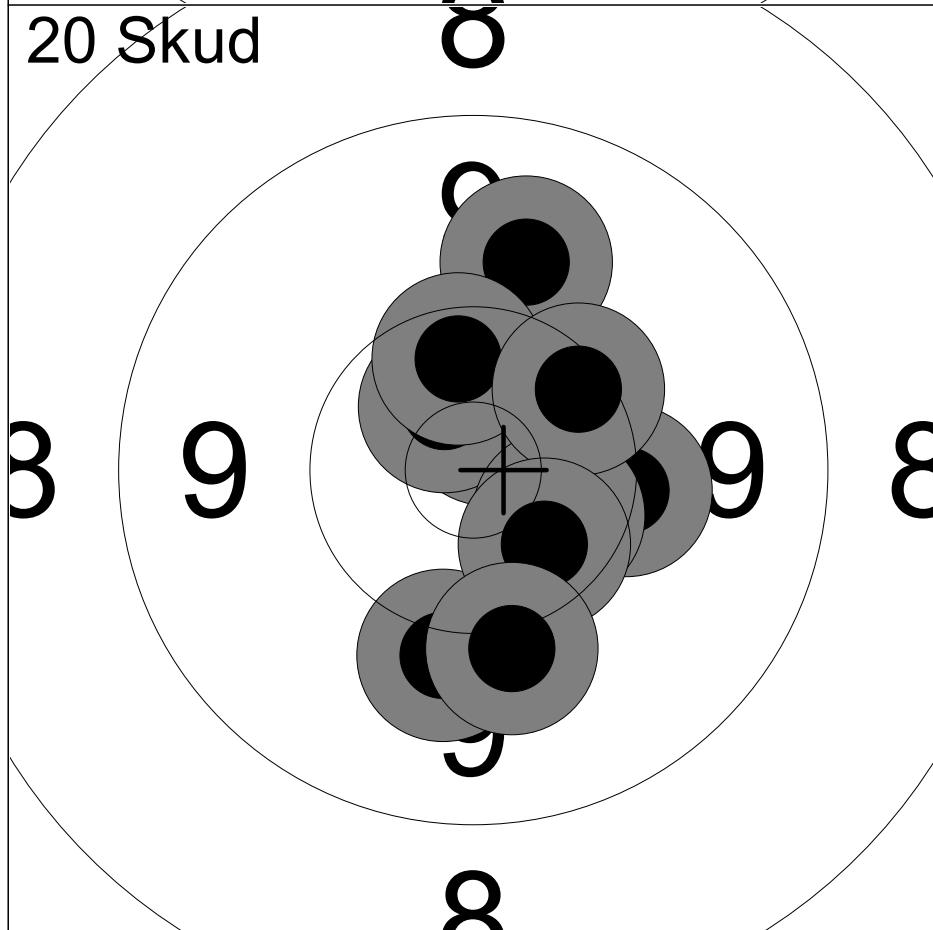

11:	10.2	→
12:	10.7x	↑
13:	10.0	↓
14:	10.6x	↑
15:	9.9	↑
16:	10.5x	↘
17:	10.4	↑
18:	10.3	↗
19:	10.5x	↓
20:	10.1	↓
Serie		99 ( 4x)
Total		199 (11x)

Hold <b>4</b>	Skive <b>3</b>	<b>Jens Bengtson</b>		
50m		Melby Skytteforening	SE1	
09.08.2025		EM 2025	Hanebjerg Skyttecenter	
Kommentar		Signatur		

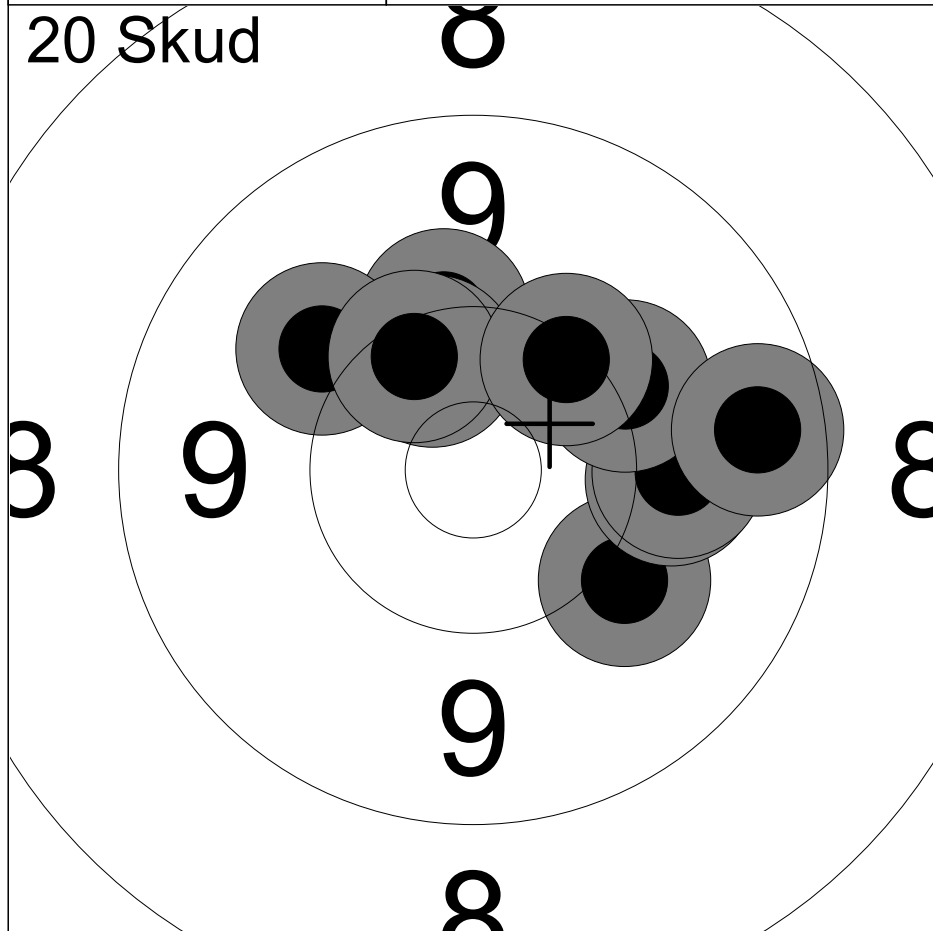

1:	10.2	↗
2:	10.0	↘
3:	10.0	→
4:	10.0	→
5:	10.1	↗
6:	10.0	↗
7:	10.4	↗
8:	9.5	→
9:	10.3	↗
10:	10.3	↗
Serie		99 ( 0x)
Total		99 ( 0x)

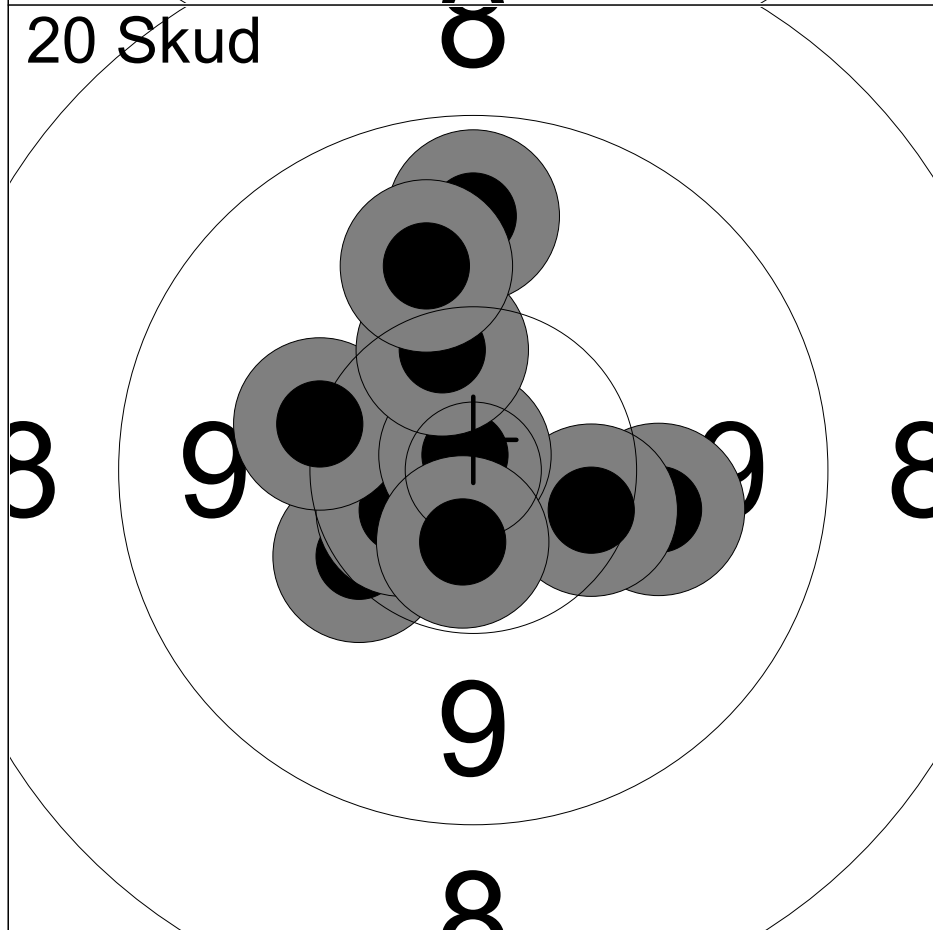

11:	10.0	→
12:	10.3	↖
13:	10.6x	↖
14:	10.2	↖
15:	9.7	↑
16:	10.3	↘
17:	10.9x	↗
18:	10.3	↑
19:	9.9	↑
20:	10.6x	↘
Serie		98 ( 3x)
Total		197 ( 3x)

Hold <b>4</b>	Skive <b>4</b>	<b>Finn Jensen</b>		
50m		Melby Skytteforening	SE1	
09.08.2025		EM 2025	Hanebjerg Skyttecenter	
Kommentar		Signatur		

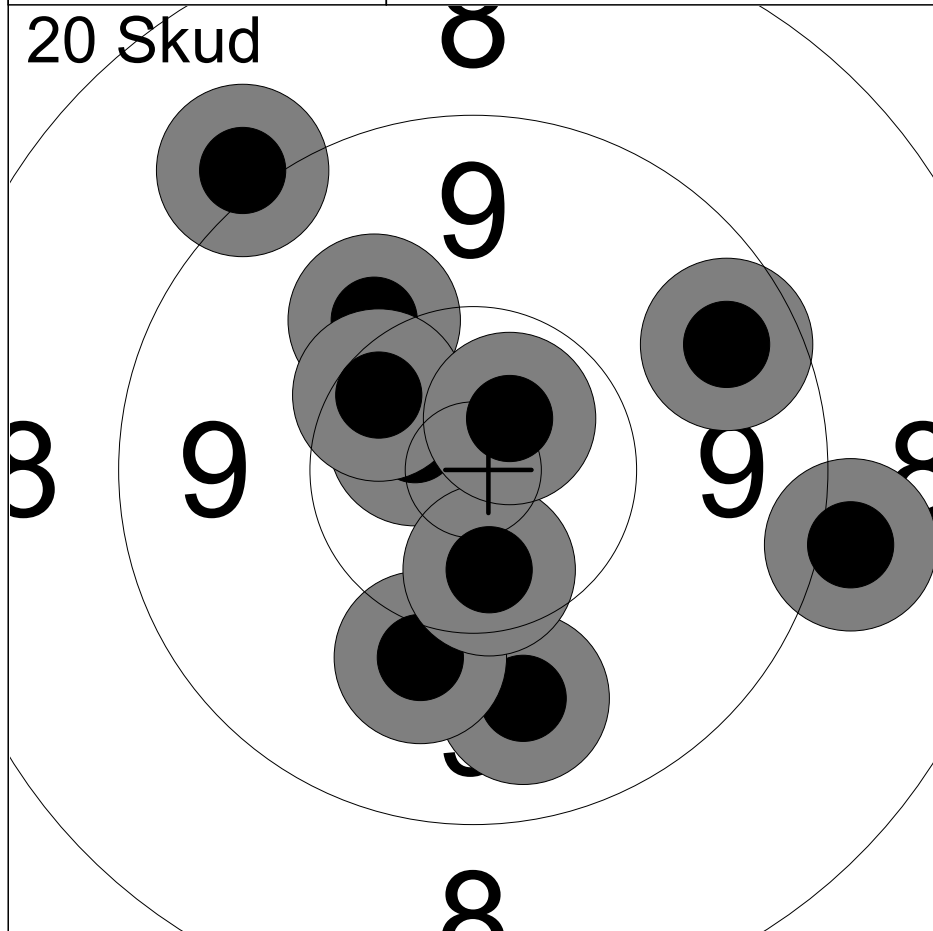

1:	9.1	↗
2:	10.6x	↗
3:	9.8	↘
4:	10.1	↗
5:	10.0	↘
6:	10.5x	↘
7:	10.4	↗
8:	9.0	→
9:	9.5	↗
10:	10.6x	↗
Serie		96 ( 3x)
Total		96 ( 3x)

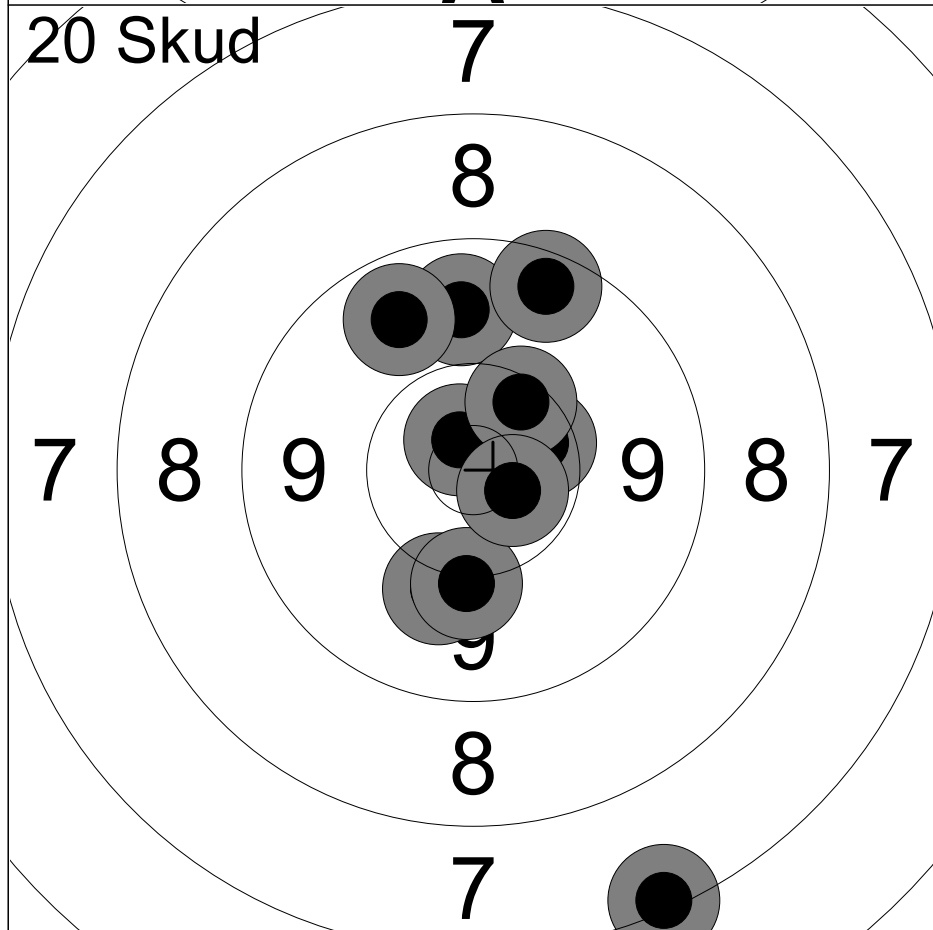

11:	9.7	↑
12:	10.7x	↗
13:	10.4	→
14:	9.7	↗
15:	10.0	↘
16:	7.3	↘
17:	10.3	↗
18:	9.4	↗
19:	10.1	↘
20:	10.6x	↘
Serie		94 ( 2x)
Total		190 ( 5x)

Hold <b>5</b>	Skive <b>1</b>	<b>Stefan Misfeldt Kvist-Andersen</b>	
50m	Ganløse Skytteforening	MÅ1	
09.08.2025	EM 2025	Hanebjerg Skyttecenter	
Kommentar	Signatur		

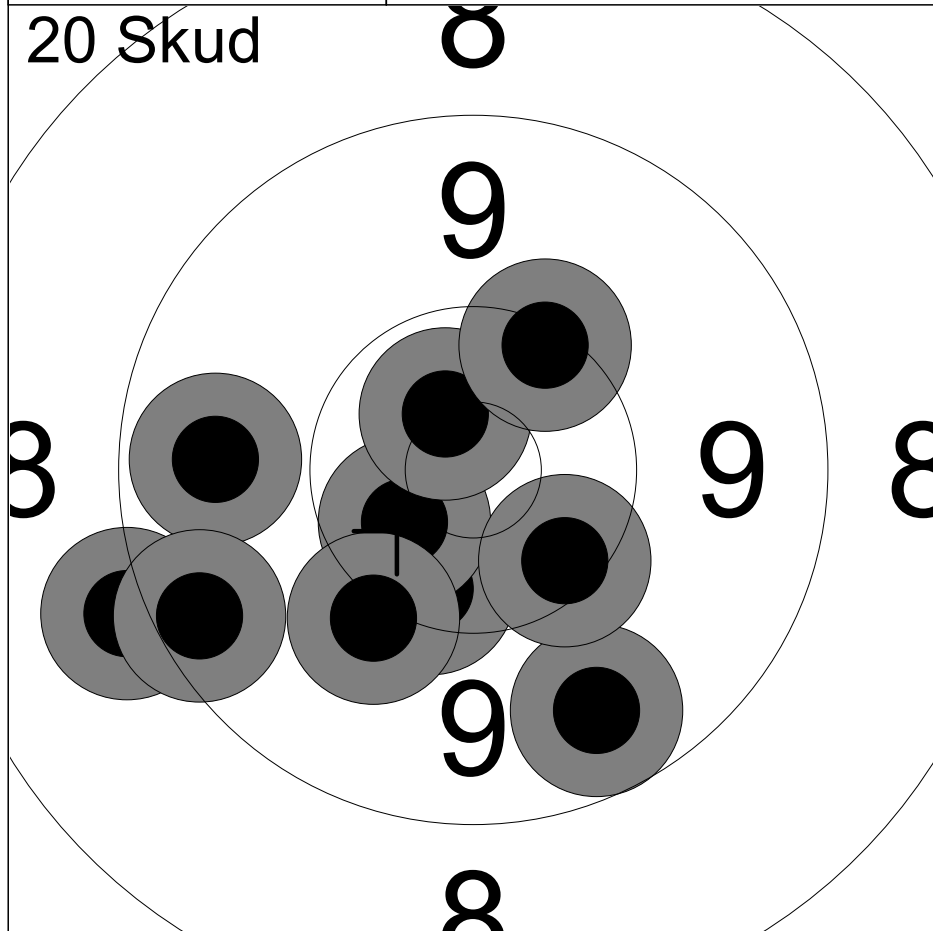

1:	10.3	↘
2:	10.5x	↙
3:	9.7	←
4:	9.6	↘
5:	10.3	↘
6:	9.1	←
7:	10.6x	↗
8:	9.4	←
9:	10.1	↘
10:	10.3	↗
Serie		96 ( 2x)
Total		96 ( 2x)

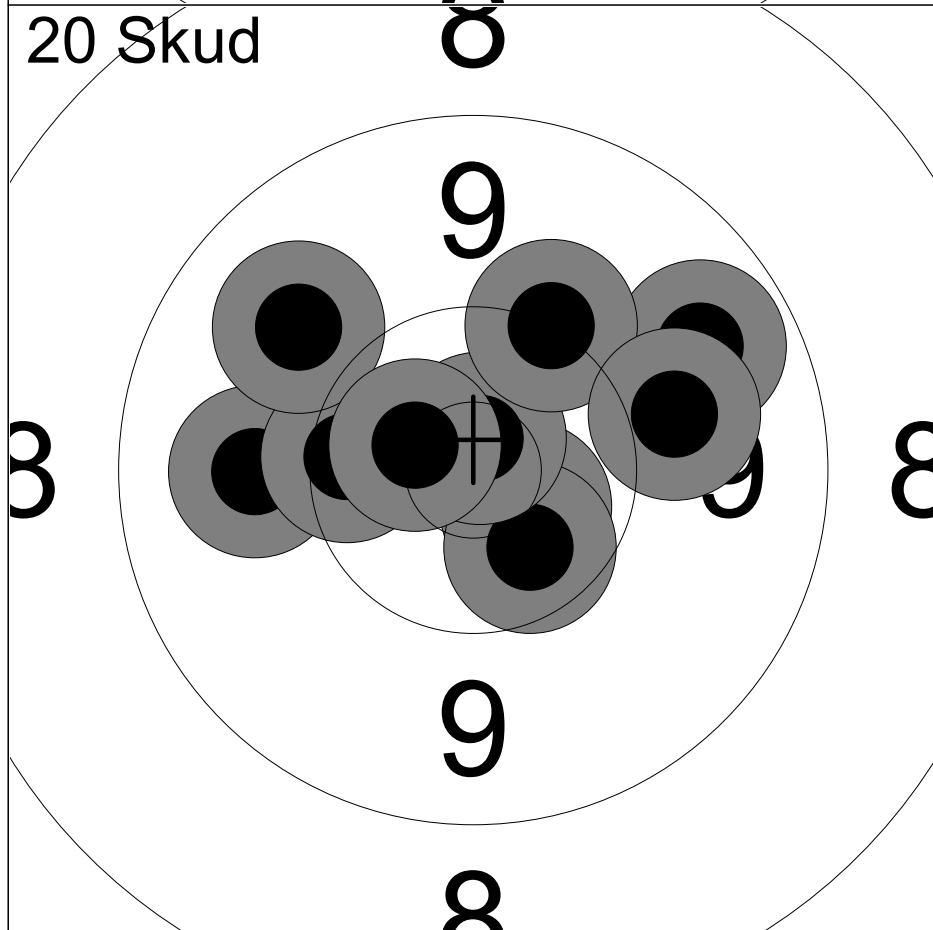

11:	10.6x	↘
12:	9.9	←
13:	10.3	←
14:	10.5x	↘
15:	9.7	↗
16:	9.8	↗
17:	10.8x	↗
18:	10.2	↗
19:	9.9	→
20:	10.6x	↙
Serie		96 ( 4x)
Total		192 ( 6x)

Hold <b>5</b>	Skive <b>2</b>	<b>Simone Misfeldt Kvist-Andersen</b>	
50m	Frederikssund Skytteforening, I	MÅ1	
09.08.2025	EM 2025	Hanebjerg Skyttecenter	
Kommentar	Signatur		

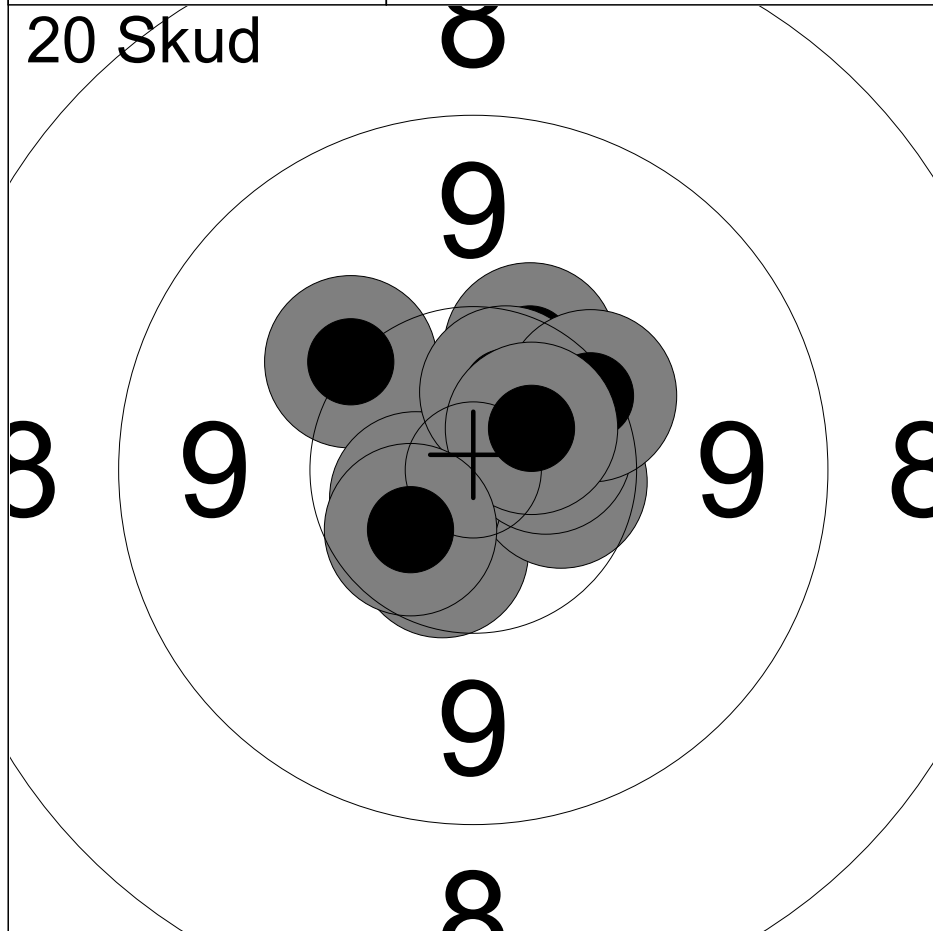

1:	10.5x	↙
2:	10.5x	→
3:	10.3	↗
4:	10.2	↖
5:	10.6x	↙
6:	10.5x	↗
7:	10.6x	→
8:	10.3	↗
9:	10.6x	↗
10:	10.5x	↙
Serie		100 ( 7x)
Total		100 ( 7x)

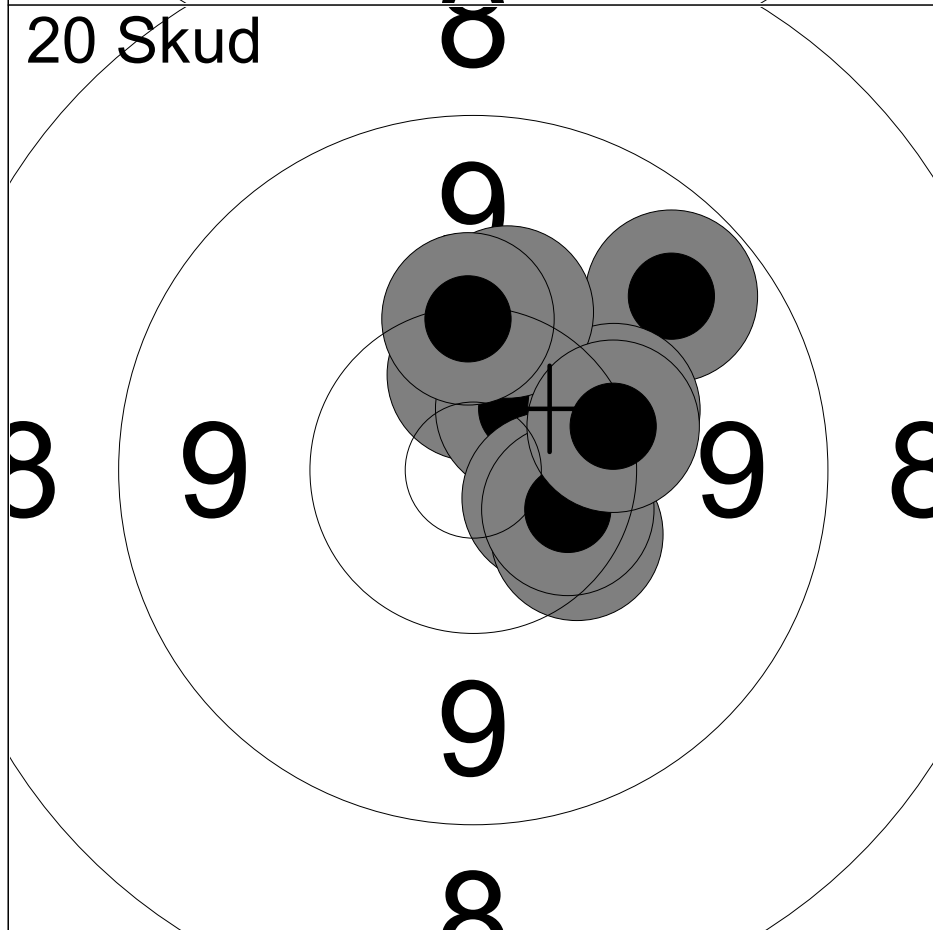

11:	10.5x	↑
12:	10.6x	↗
13:	10.6x	→
14:	9.6	↗
15:	10.2	↗
16:	10.4	↘
17:	10.5x	→
18:	10.2	↑
19:	10.2	↑
20:	10.2	→
Serie		99 ( 4x)
Total		199 (11x)

Hold <b>6</b>	Skive <b>3</b>	<b>Jens Bengtson</b>		
50m		Melby Skytteforening	MSE1	
09.08.2025		EM 2025	Hanebjerg Skyttecenter	
Kommentar		Signatur		

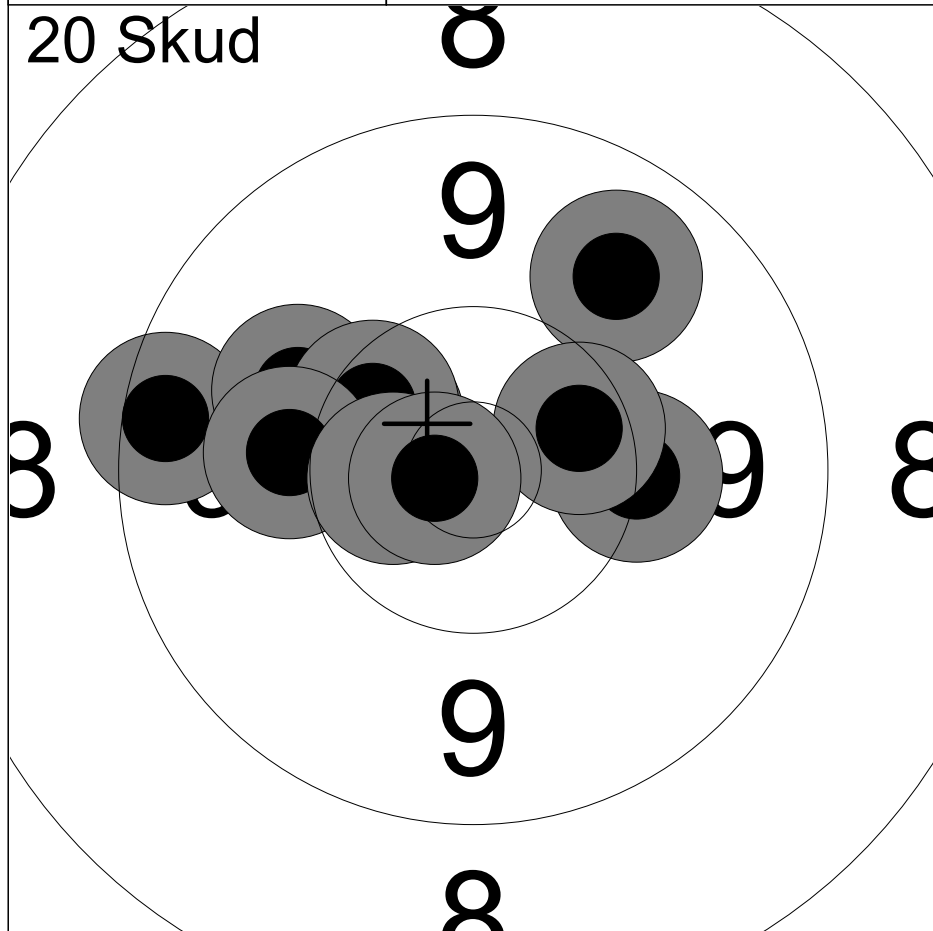

1:	10.4x	↖
2:	9.8	↗
3:	9.4	↖
4:	10.2	→
5:	10.0	↖
6:	10.4	↗
7:	10.4	↗
8:	10.1	↖
9:	10.6x	↖
10:	10.8x	↖
Serie		98 ( 3x)
Total		98 ( 3x)

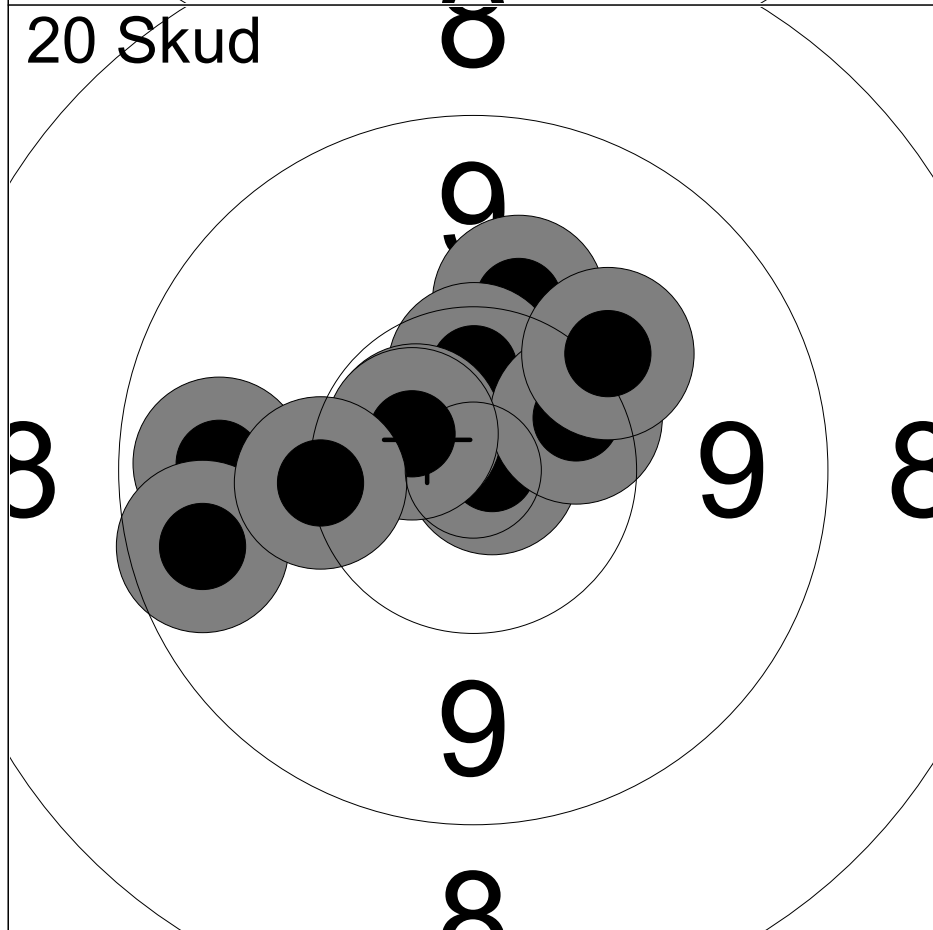

11:	10.9x	→
12:	10.1	↗
13:	10.5x	↗
14:	9.7	↖
15:	10.6x	↖
16:	9.6	↖
17:	10.4	↗
18:	10.6x	↖
19:	10.1	↗
20:	10.2	↖
Serie		98 ( 4x)
Total		196 ( 7x)

Hold <b>6</b>	Skive <b>4</b>	<b>Finn Jensen</b>		
50m		Melby Skytteforening	MSE1	
09.08.2025		EM 2025	Hanebjerg Skyttecenter	
Kommentar		Signatur		

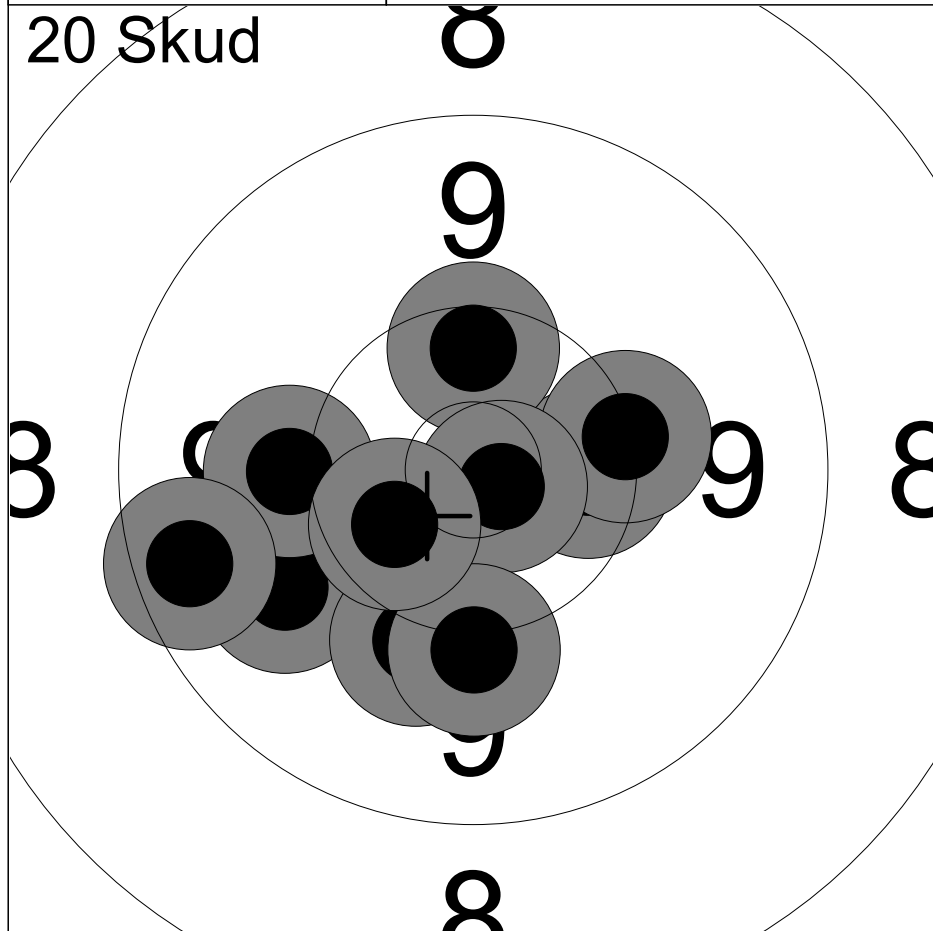

1:	9.9	↙
2:	10.4	→
3:	10.2	→
4:	10.1	↙
5:	10.4	↑
6:	10.1	↘
7:	10.8x	↘
8:	10.1	↓
9:	10.5x	↙
10:	9.5	↙
Serie		98 ( 2x)
Total		98 ( 2x)

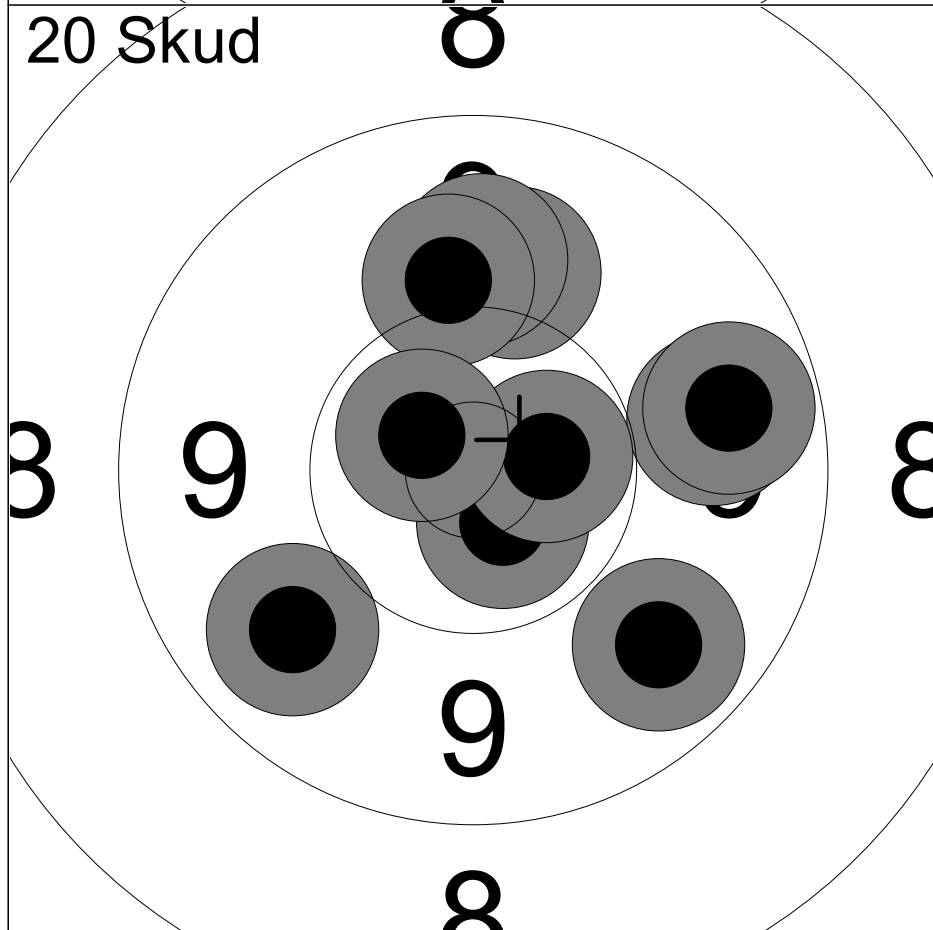

11:	10.0	↑
12:	9.9	↑
13:	9.8	↙
14:	10.0	↑
15:	9.7	↘
16:	9.7	→
17:	10.7x	↘
18:	10.6x	→
19:	9.7	→
20:	10.6x	↙
Serie		95 ( 3x)
Total		193 ( 5x)

Hold <b>6</b>	Skive <b>12</b>	<b>Jonas Keiding</b>	
50m	Kreds 57, Ferslev, Skibby	J2	
09.08.2025	EM 2025	Hanebjerg Skyttecenter	
Kommentar	Signatur		

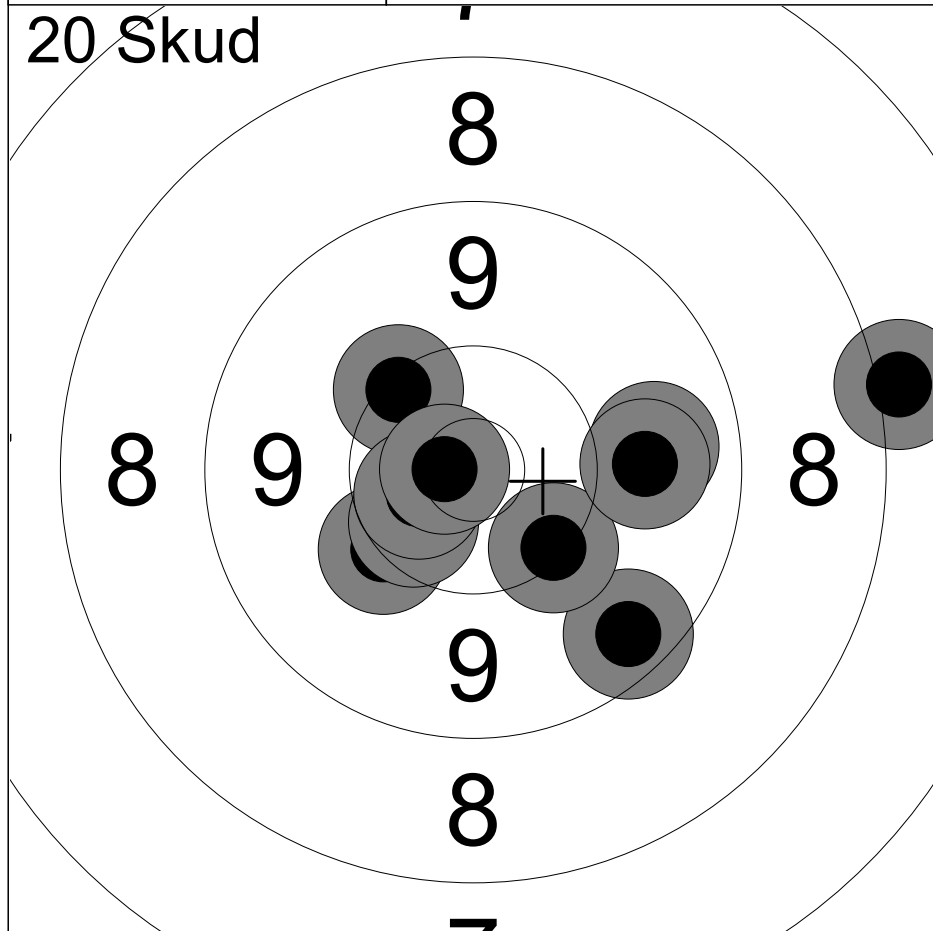

1:	9.5	↘
2:	9.8	→
3:	8.0	→
4:	10.2	↗
5:	10.2	↙
6:	10.2	↘
7:	9.8	→
8:	10.4x	↙
9:	10.6x	↙
10:	10.8x	←

Serie	95 ( 3x)
Total	95 ( 3x)

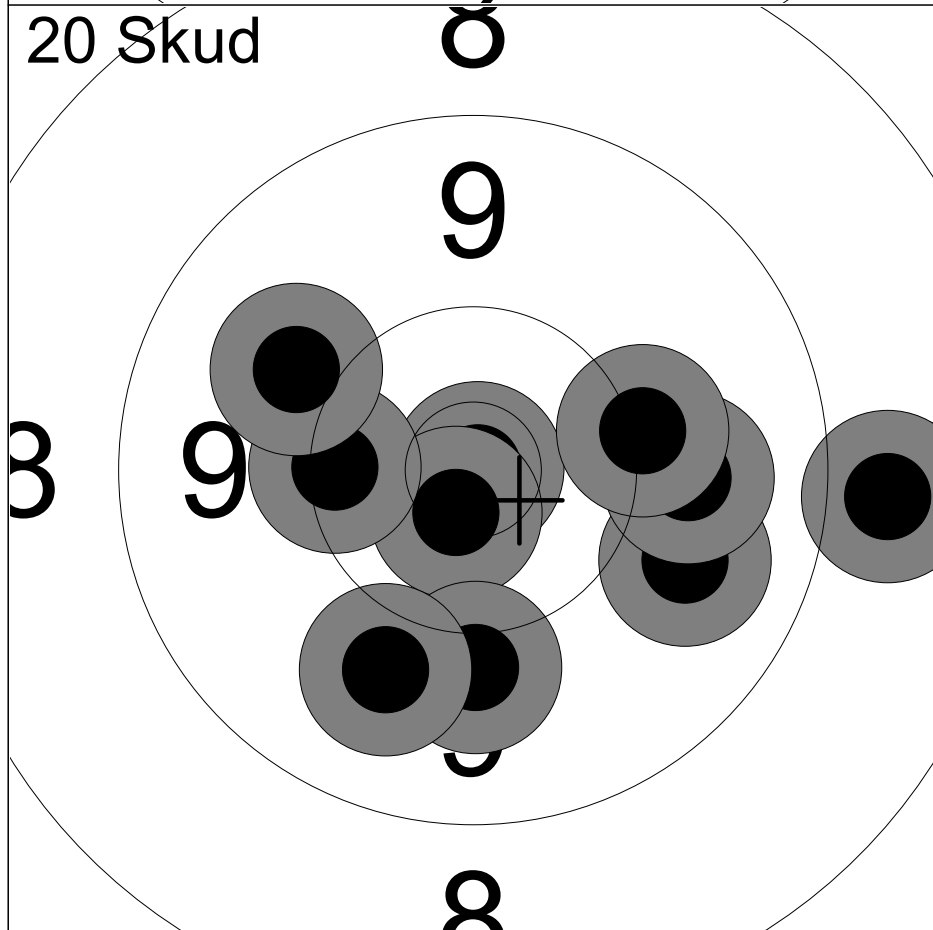

11:	10.9x	↗
12:	8.9	→
13:	10.7x	↘
14:	10.3	←
15:	9.8	↘
16:	10.0	↘
17:	10.0	↗
18:	9.9	↘
19:	9.9	→
20:	10.1	→

Serie	95 ( 2x)
Total	190 ( 5x)

Hold <b>7</b>	Skive <b>11</b>	<b>Thomas Andreassen</b>	
50m		Ølstykke Skytteforening	Å2
09.08.2025		EM 2025	Hanebjerg Skyttecenter
Kommentar		Signatur	

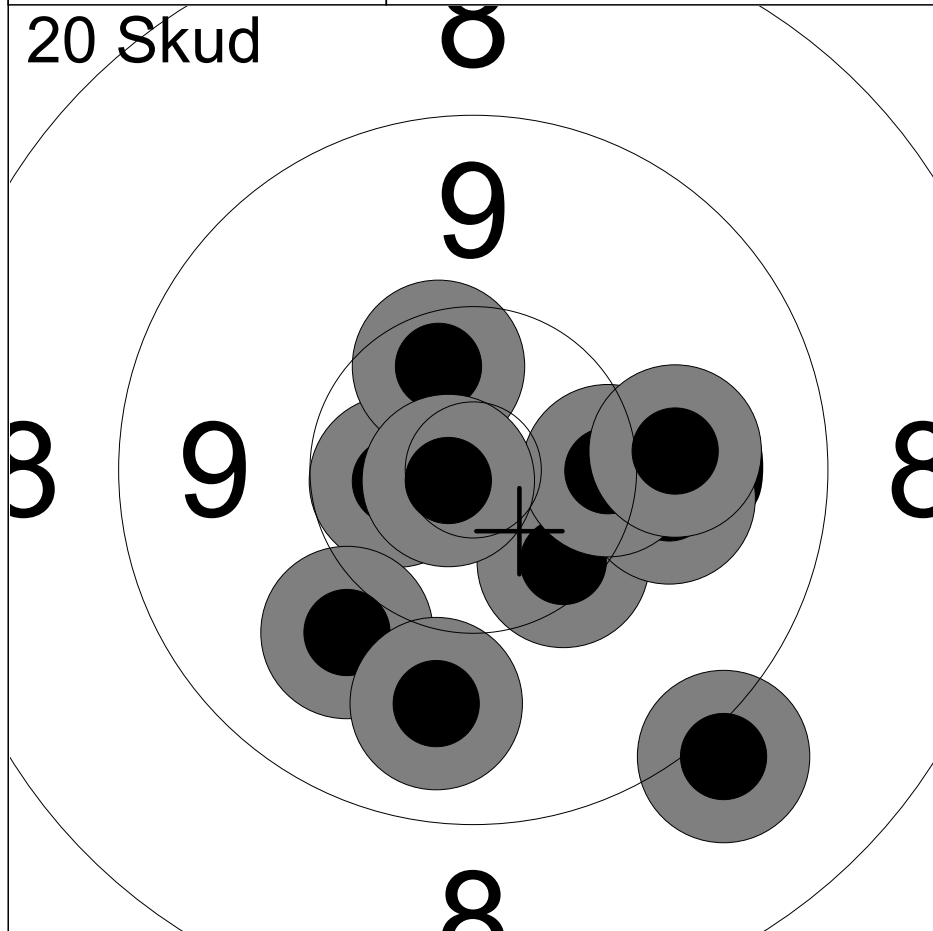

1:	9.0	↘
2:	10.6x	←
3:	10.3	↘
4:	10.0	↙
5:	9.8	↘
6:	10.0	→
7:	10.4x	↗
8:	10.3	→
9:	10.8x	←
10:	10.0	→
Serie		98 ( 3x)
Total		98 ( 3x)

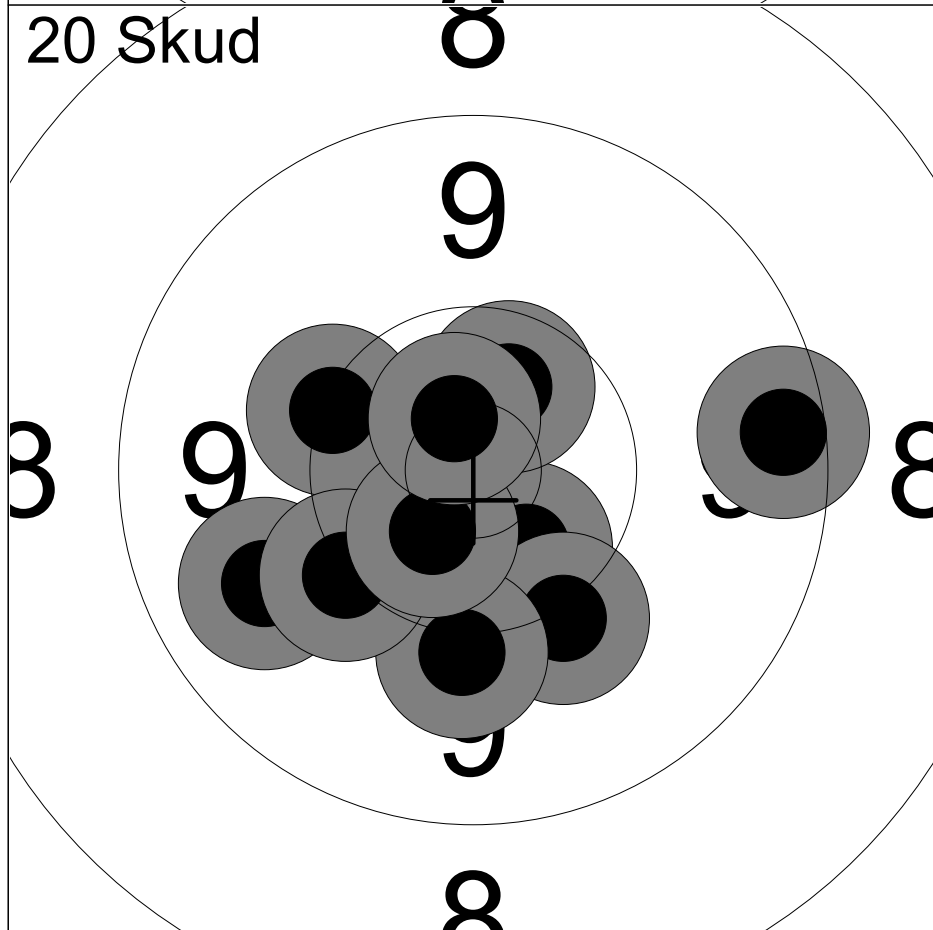

11:	9.8	←
12:	10.5x	↘
13:	10.1	↘
14:	10.1	↘
15:	9.4	→
16:	10.2	↖
17:	10.1	↖
18:	10.5x	↗
19:	10.6x	↘
20:	10.7x	↗
Serie		98 ( 4x)
Total		196 ( 7x)

Hold <b>8</b>	Skive <b>6</b>	<b>Thomas Pedersen</b>	
50m	Jørlunde Skytteforening	ST3	
09.08.2025	EM 2025	Hanebjerg Skyttecenter	
Kommentar	Signatur		

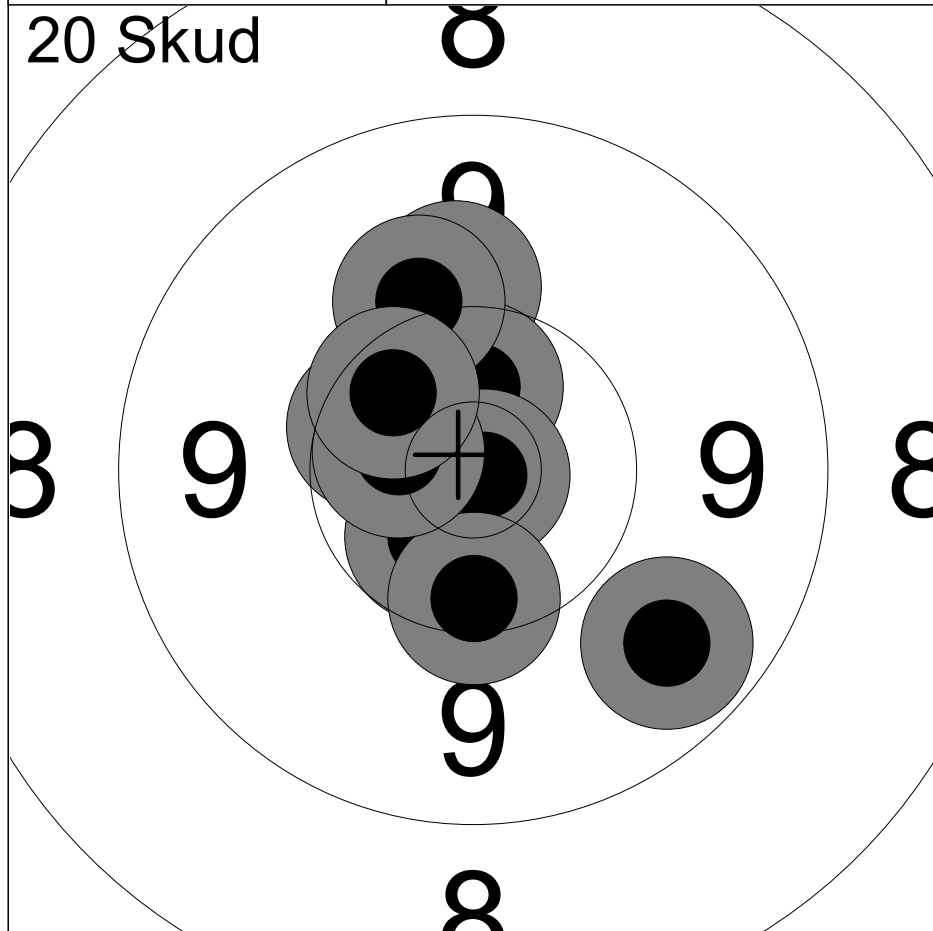

1:	10.4x	↖
2:	10.1	↑
3:	10.6x	↙
4:	10.5x	↑
5:	10.9x	↘
6:	9.7	↘
7:	10.1	↑
8:	10.3	↓
9:	10.6x	↖
10:	10.4	↖
Serie		99 ( 5x)
Total		99 ( 5x)

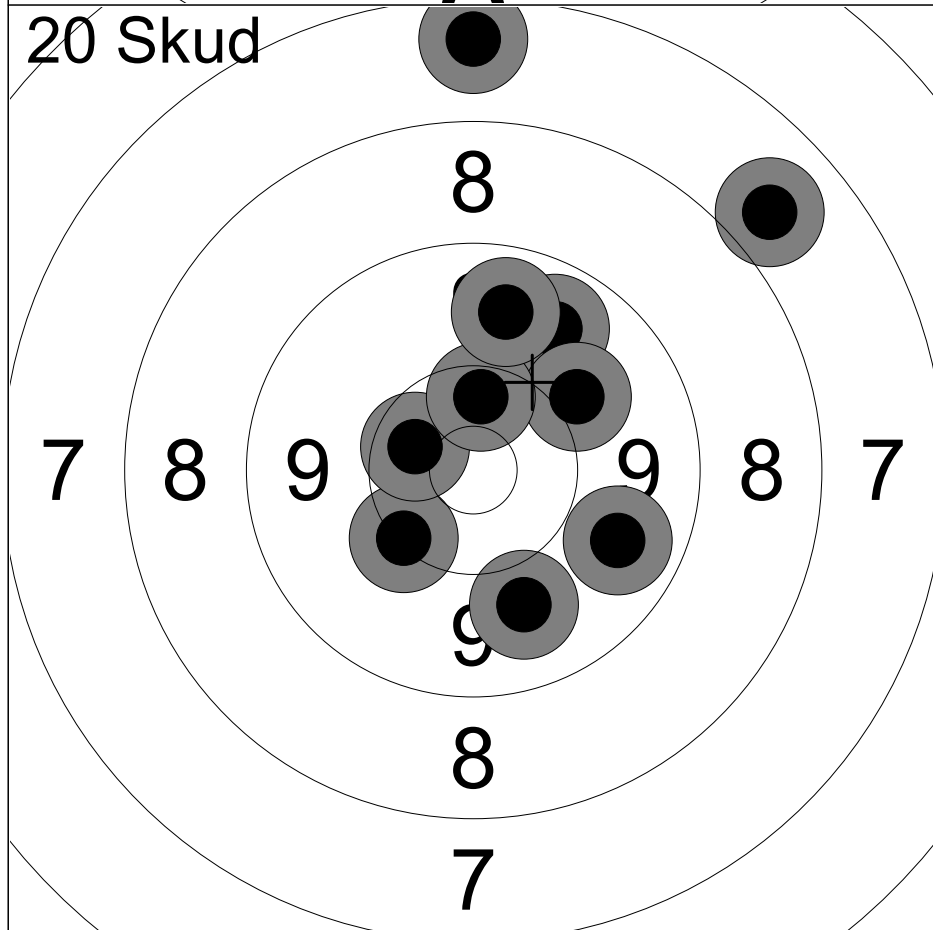

11:	7.5	↑
12:	10.2	↙
13:	9.9	↓
14:	9.7	↗
15:	7.8	↗
16:	9.7	↘
17:	10.0	↗
18:	10.5x	↖
19:	10.4	↑
20:	9.7	↑
Serie		90 ( 1x)
Total		189 ( 6x)

Hold <b>8</b>	Skive <b>9</b>	<b>Jonas Keiding</b>		
50m	Kreds 57, Ferslev, Skibby		MJ2	
09.08.2025	EM 2025	Hanebjerg Skyttecenter		
Kommentar	Signatur			

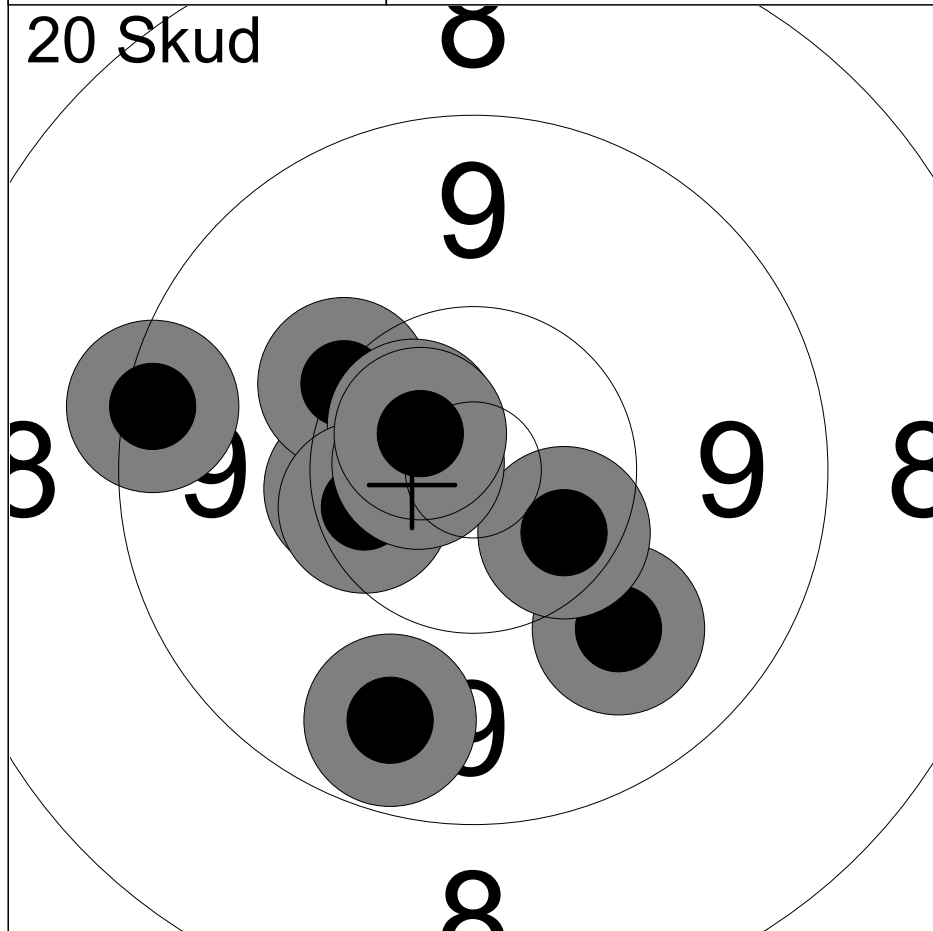

1:	10.3	←
2:	10.2	↗
3:	9.9	↘
4:	10.6x	↗
5:	10.4	←
6:	10.4x	↘
7:	9.3	←
8:	9.6	↘
9:	10.7x	←
10:	10.6x	↗

Serie	97 ( 4x)
Total	97 ( 4x)

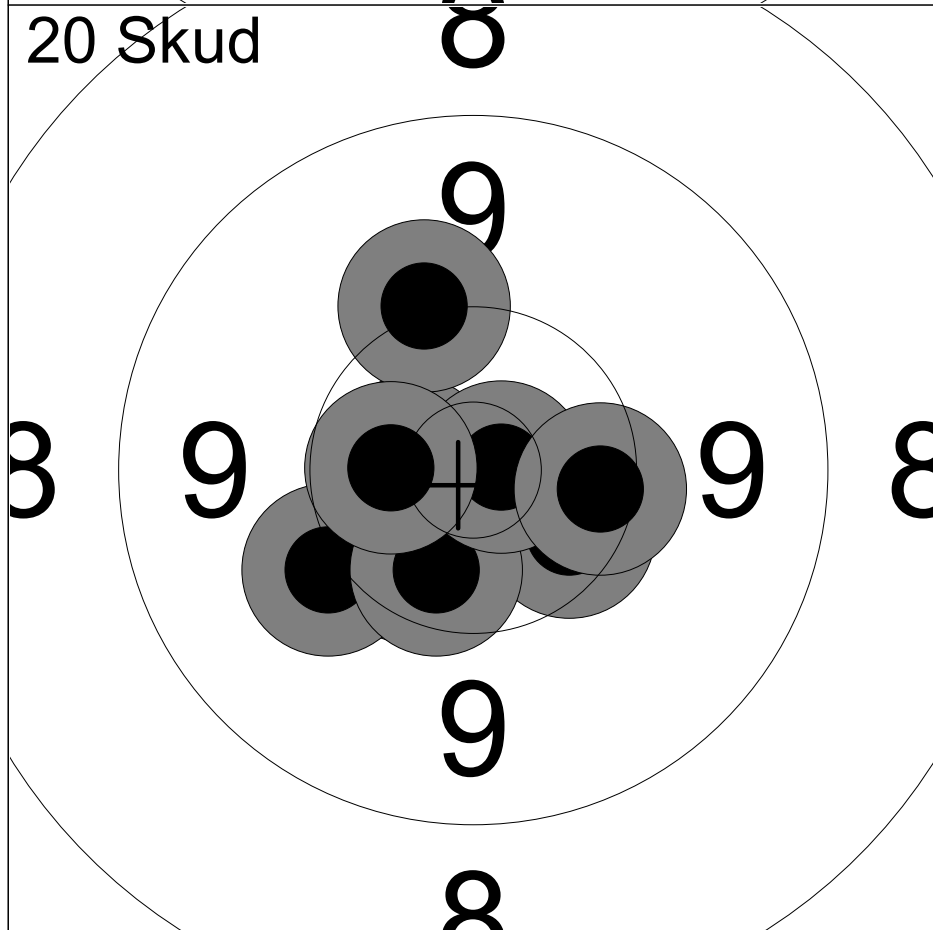

11:	10.4x	↘
12:	10.9x	↘
13:	10.4	↘
14:	10.6x	←
15:	10.1	↙
16:	10.4x	↘
17:	10.8x	→
18:	10.3	→
19:	10.1	↗
20:	10.6x	←

Serie	100 ( 6x)
Total	197 (10x)

Hold <b>8</b>	Skive <b>11</b>	<b>Thomas Andreassen</b>	
50m		Ølstykke Skytteforening	MÅ2
09.08.2025		EM 2025	Hanebjerg Skyttecenter
Kommentar		Signatur	

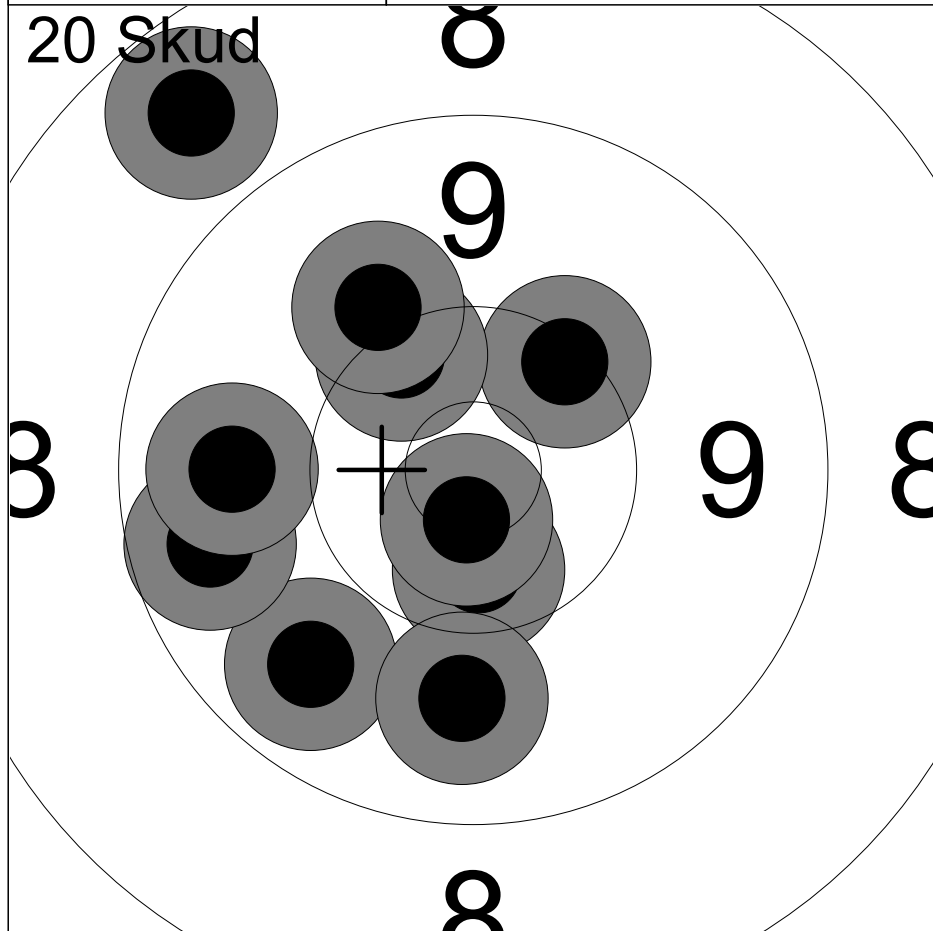

1:	10.5x	↓
2:	9.7	↙
3:	9.6	←
4:	9.8	←
5:	8.6	↗
6:	9.8	↓
7:	10.7x	↓
8:	10.3	↗
9:	10.3	↗
10:	10.0	↗

Serie	94 ( 2x)
Total	94 ( 2x)

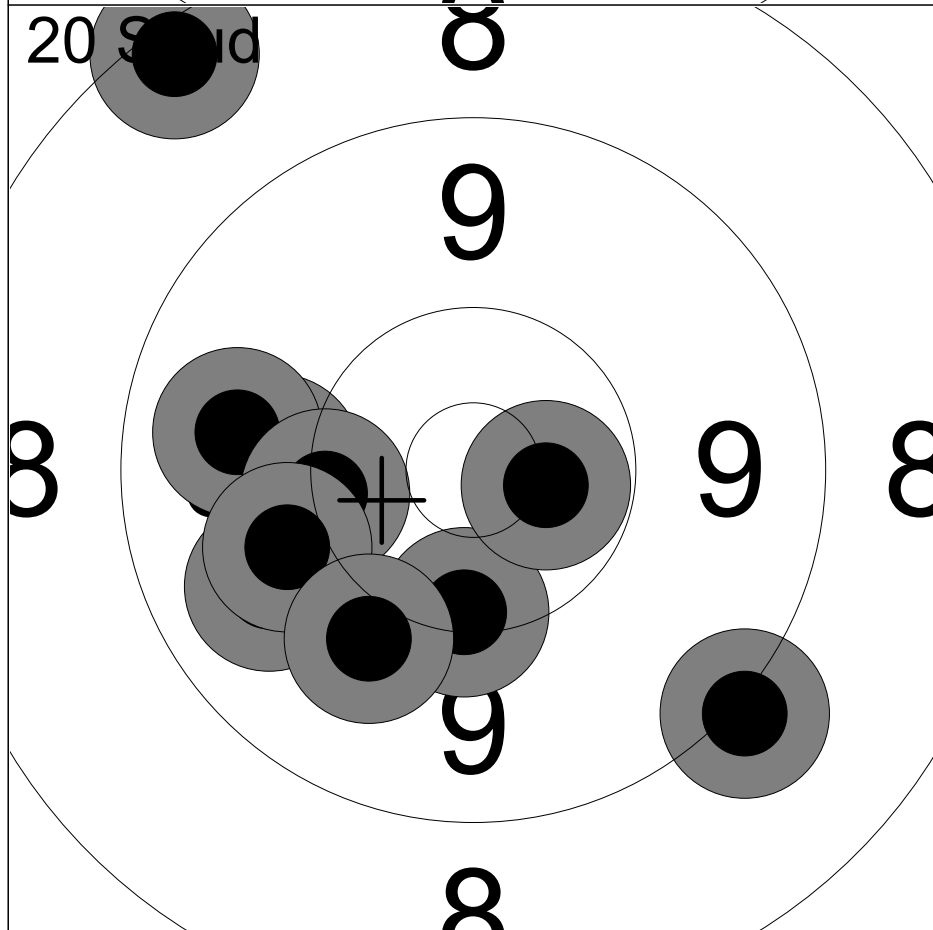

11:	10.3	↓
12:	10.6x	→
13:	10.0	←
14:	9.8	←
15:	9.8	↙
16:	9.1	↘
17:	10.2	←
18:	10.0	←
19:	10.0	↘
20:	8.3	↗

Serie	95 ( 1x)
Total	189 ( 3x)

Hold <b>10</b>	Skive <b>6</b>	<b>Thomas Pedersen</b>		
50m	Jørlunde Skytteforening	MST3		
09.08.2025	EM 2025	Hanebjerg Skyttecenter		
Kommentar	Signatur			

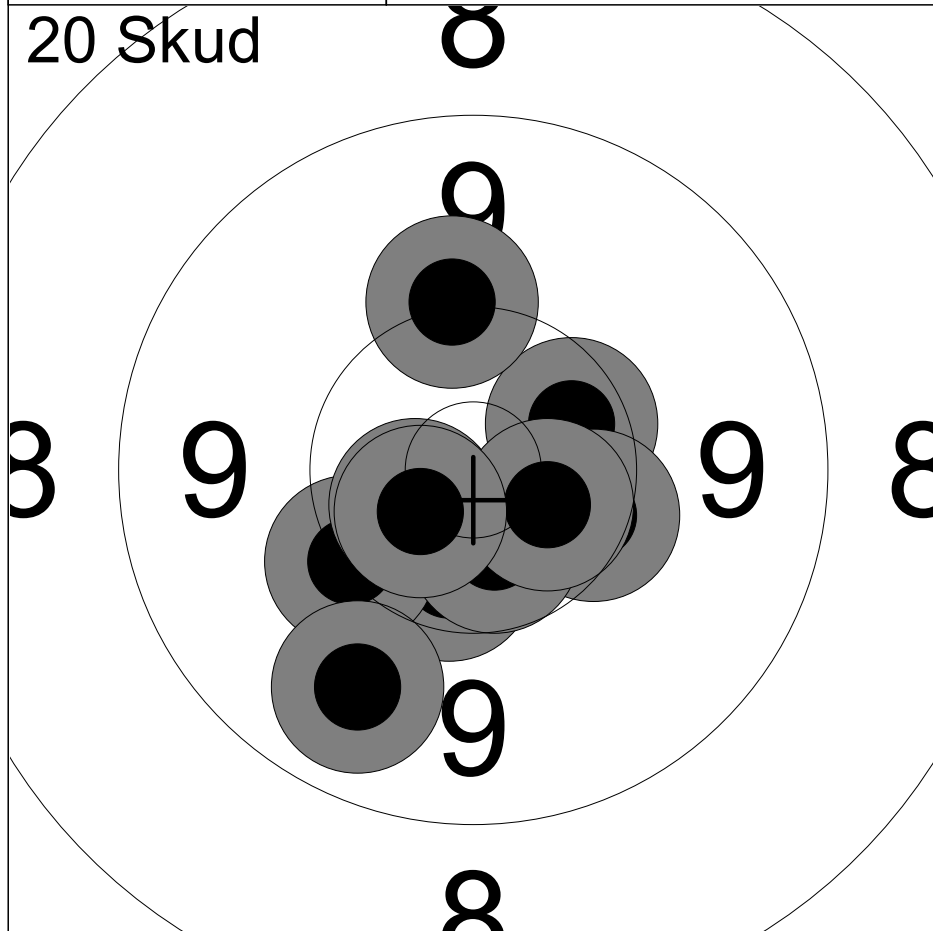

1:	10.4x	↓
2:	10.2	↙
3:	9.7	↘
4:	10.4x	↗
5:	10.3	→
6:	10.6x	↙
7:	10.6x	↓
8:	10.6x	↘
9:	10.6x	↙
10:	10.1	↑
Serie		99 ( 6x)
Total		99 ( 6x)

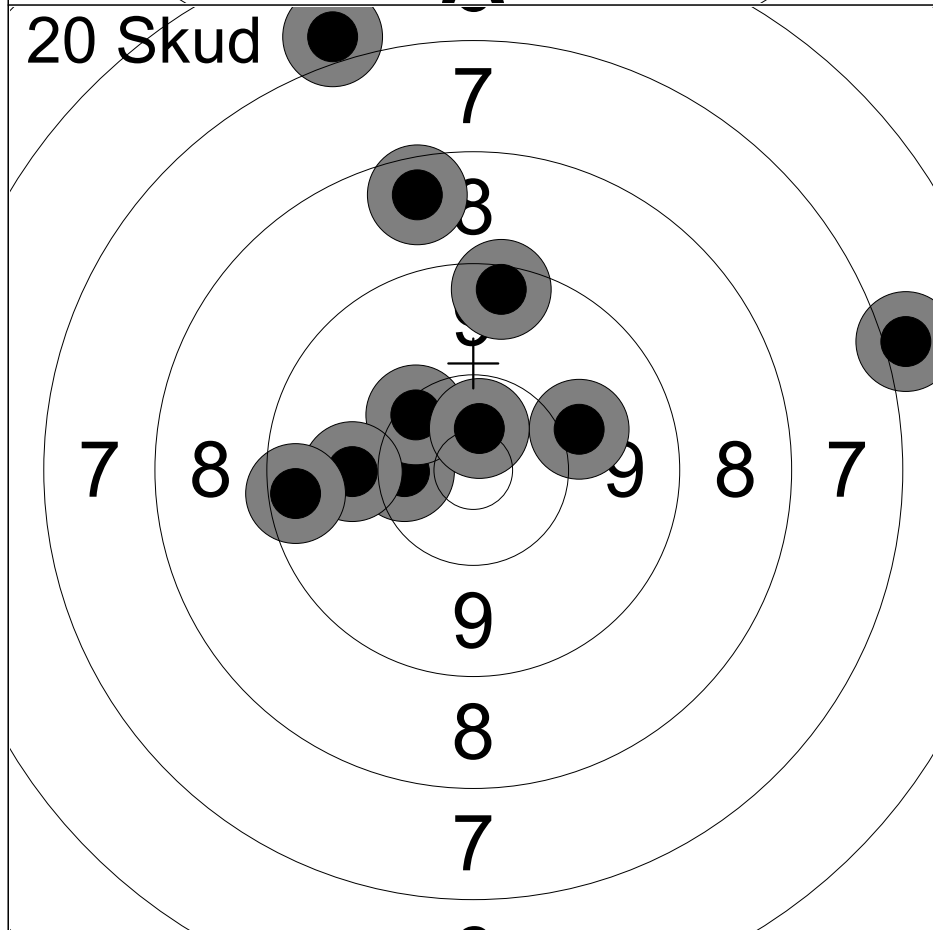

11:	6.9	↑
12:	7.0	→
13:	9.4	↑
14:	8.5	↑
15:	10.4	←
16:	10.0	↗
17:	10.3	↖
18:	9.9	←
19:	10.6x	↑
20:	9.4	←
Serie		88 ( 1x)
Total		187 ( 7x)

Hold <b>15</b>	Skive <b>1</b>	<b>Bjarne Binder</b>	
50m	Ølstykke Skytteforening	Å1	
09.08.2025	EM 2025	Hanebjerg Skyttecenter	
Kommentar	Signatur		

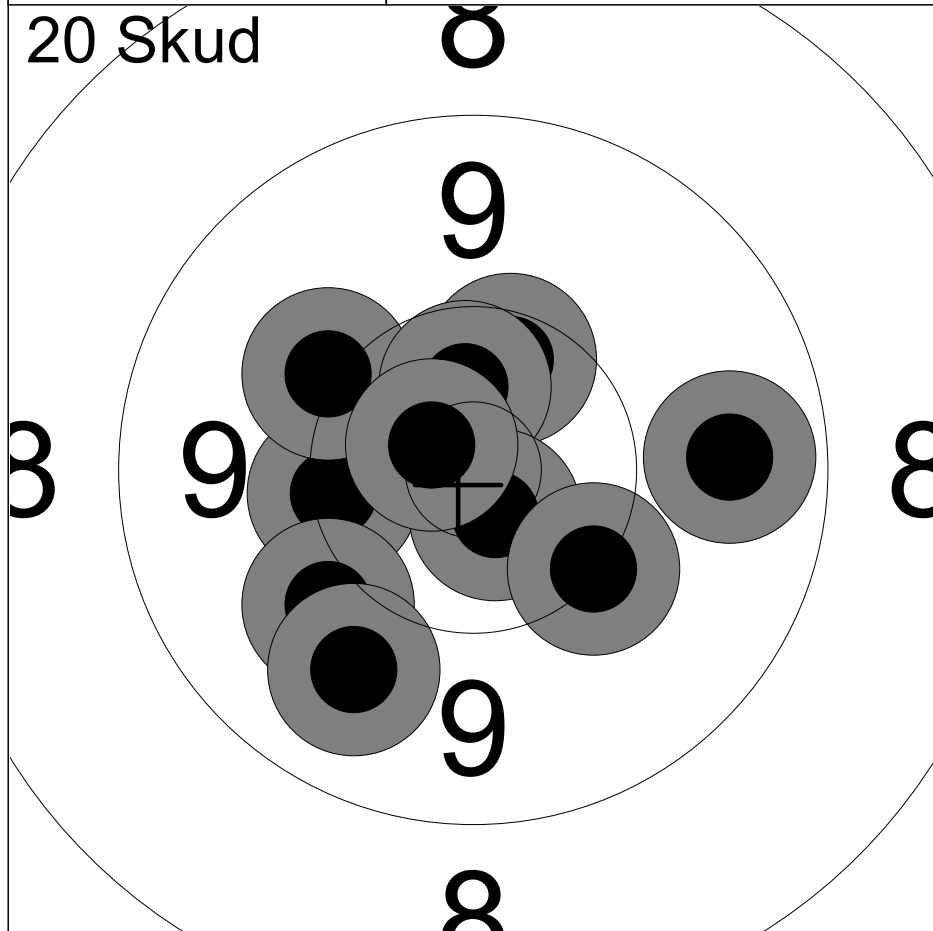

1:	10.3	←
2:	10.0	↙
3:	10.1	↗
4:	9.8	↘
5:	10.4	↗
6:	10.5x	↑
7:	9.7	→
8:	10.7x	↘
9:	10.2	↘
10:	10.7x	↗
Serie		98 ( 3x)
Total		98 ( 3x)

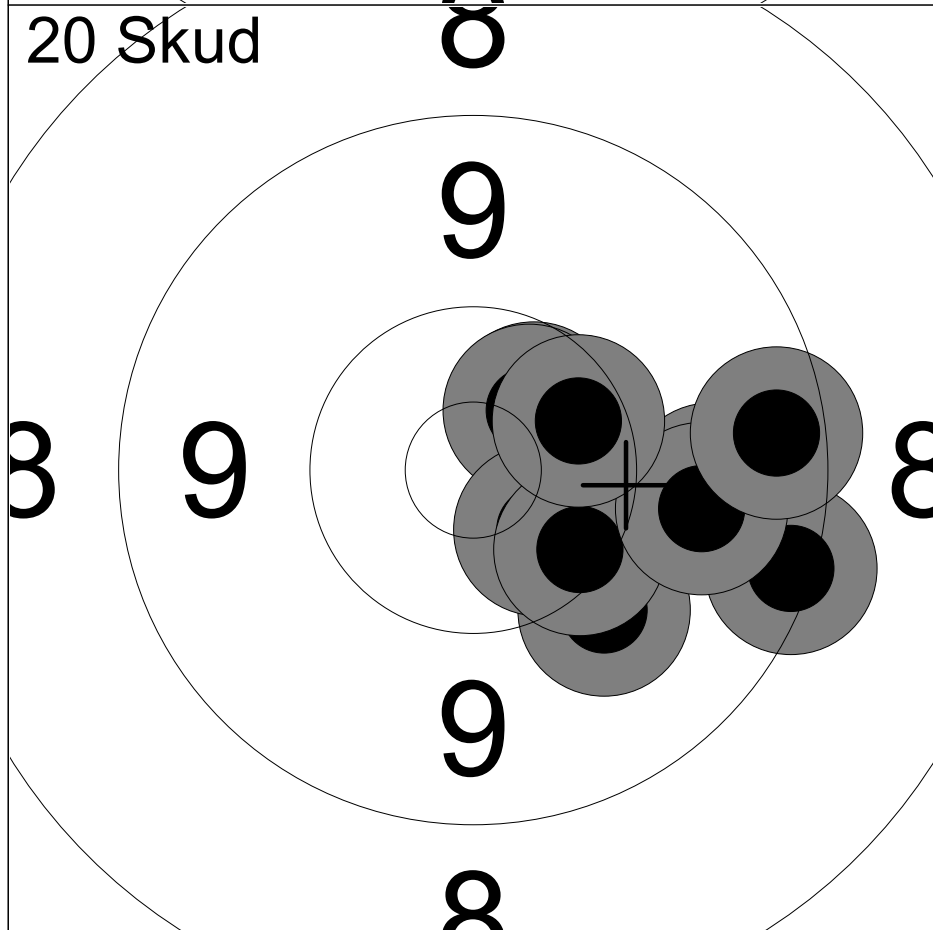

11:	10.5x	↗
12:	9.8	→
13:	10.0	↘
14:	10.6x	↗
15:	9.3	↘
16:	10.5x	↘
17:	10.3	↘
18:	9.8	→
19:	10.4	↗
20:	9.4	→
Serie		96 ( 3x)
Total		194 ( 6x)

Hold <b>15</b>	Skive <b>8</b>	<b>Anton Ellegaard Soerensen</b>	
50m	Kreds 57, Ferslev, Skibby	Å1	
09.08.2025	EM 2025	Hanebjerg Skyttecenter	
Kommentar	Signatur		

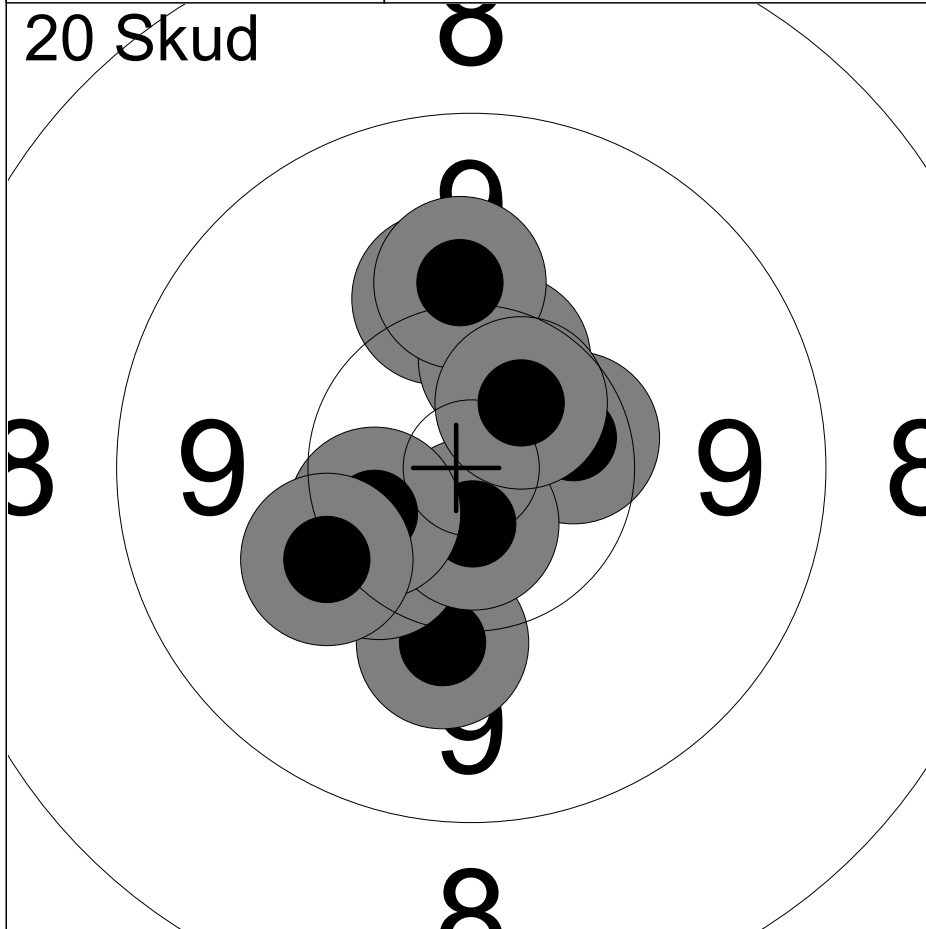

1:	10.1	↓
2:	10.1	↑
3:	10.3	↙
4:	10.4	↑
5:	10.4x	→
6:	10.0	↑
7:	10.7x	↓
8:	10.4x	↙
9:	10.6x	↗
10:	10.1	↙
Serie		100 ( 4x)
Total		100 ( 4x)

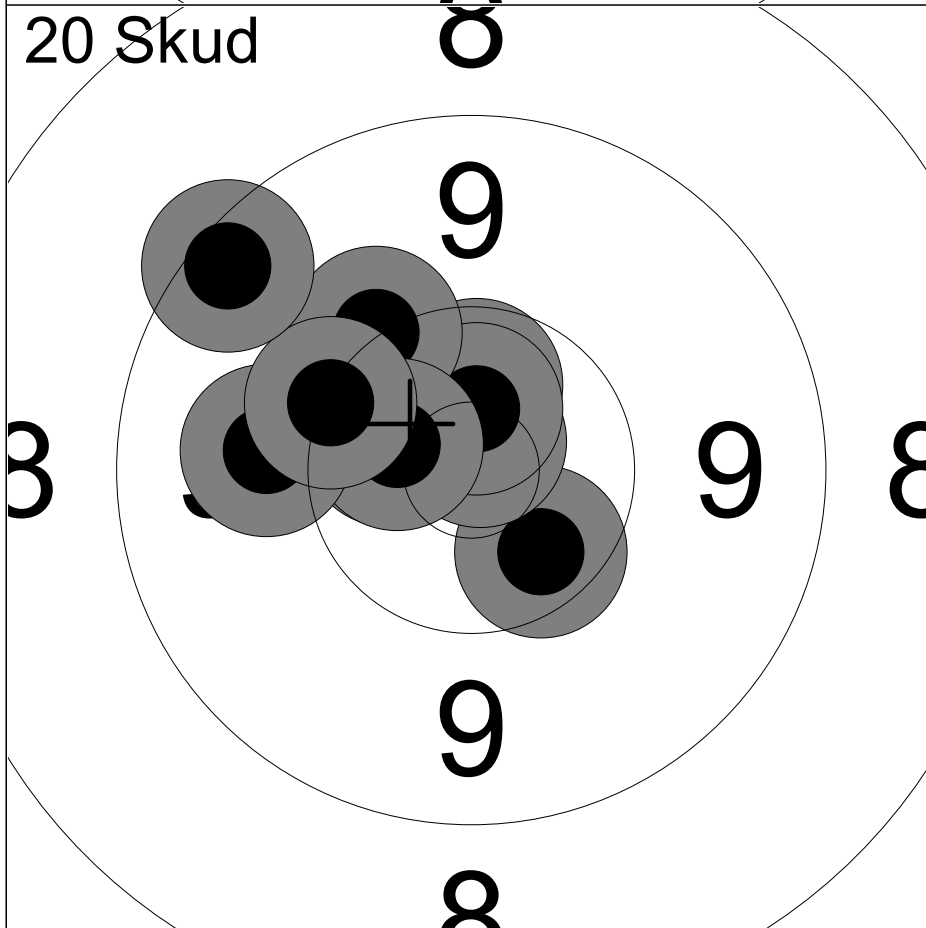

11:	10.4x	↘
12:	10.5x	↙
13:	10.5x	↑
14:	10.8x	↑
15:	10.7x	↑
16:	10.1	↗
17:	10.6x	↙
18:	10.0	↙
19:	10.2	↗
20:	9.4	↗
Serie		99 ( 6x)
Total		199 (10x)

Hold <b>16</b>	Skive <b>4</b>	<b>Kean Kofoed Noerskov</b>	
50m	Frederikssund Skytteforening, I	Å2	
09.08.2025	EM 2025	Hanebjerg Skyttecenter	
Kommentar	Signatur		

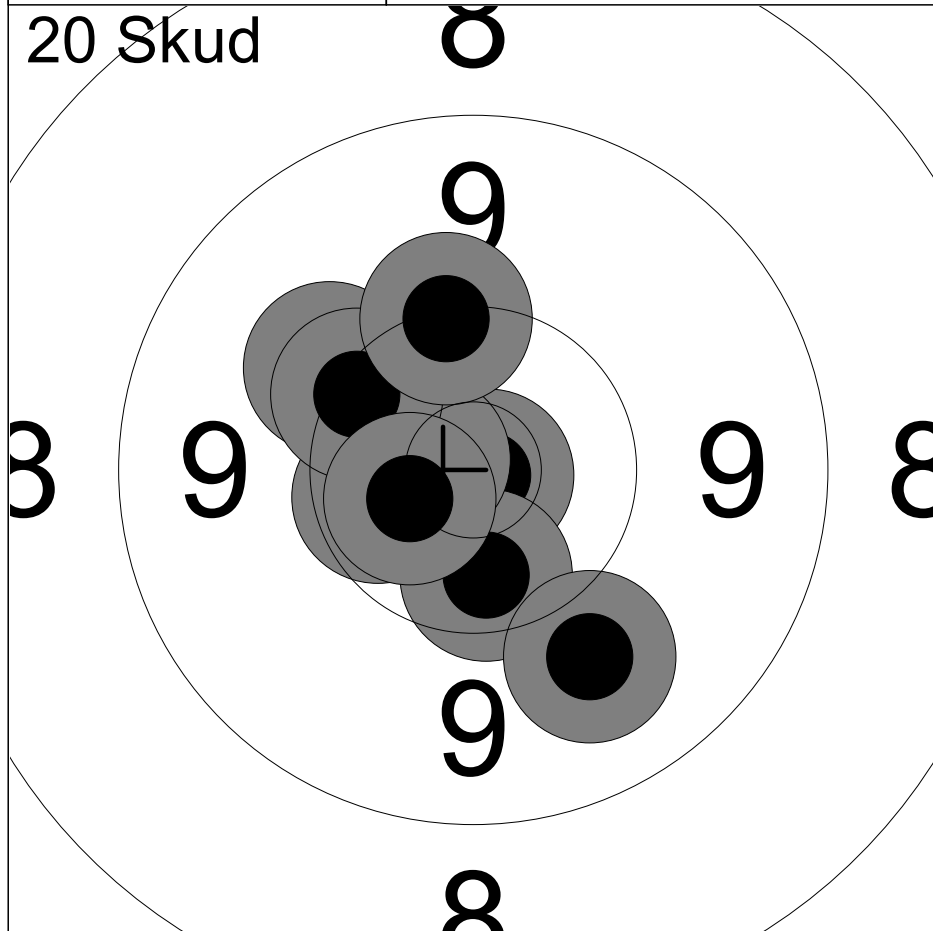

1:	10.6x	↖
2:	10.9x	↗
3:	10.4x	↘
4:	10.1	↗
5:	10.7x	↖
6:	10.5x	↖
7:	10.3	↗
8:	10.2	↗
9:	10.6x	↖
10:	9.9	↘
Serie		99 ( 6x)
Total		99 ( 6x)

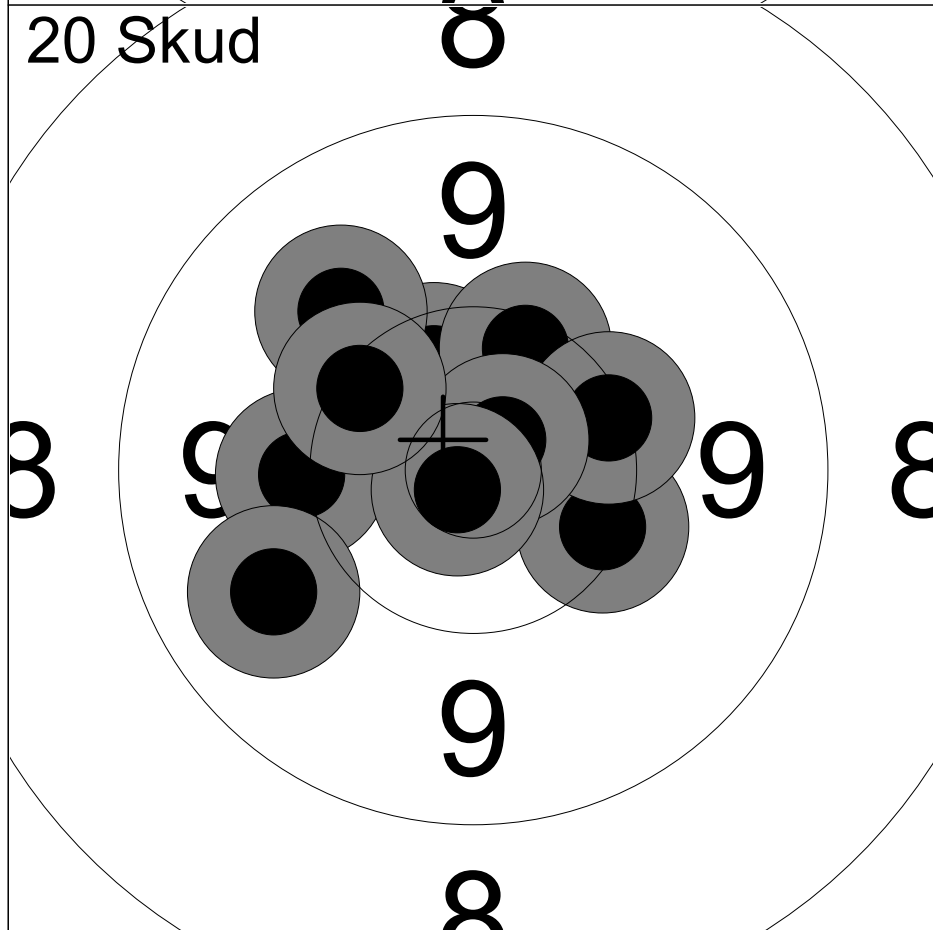

11:	10.3	↗
12:	10.4x	↗
13:	10.1	↖
14:	9.8	↖
15:	10.3	↗
16:	10.2	↗
17:	10.7x	↗
18:	10.8x	↘
19:	9.9	↗
20:	10.3	↖
Serie		98 ( 3x)
Total		197 ( 9x)

Hold <b>16</b>	Skive <b>8</b>	<b>Anton Ellegaard Soerensen</b>	
50m	Kreds 57, Ferslev, Skibby	MÅ1	
09.08.2025	EM 2025	Hanebjerg Skyttecenter	
Kommentar	Signatur		



1:	10.2	↘
2:	9.9	↘
3:	10.9x	↙
4:	10.3	↘
5:	10.4x	↗
6:	10.1	↘
7:	9.9	↗
8:	10.3	↘
9:	10.0	→
10:	10.5x	↖
Serie		98 ( 3x)
Total		98 ( 3x)

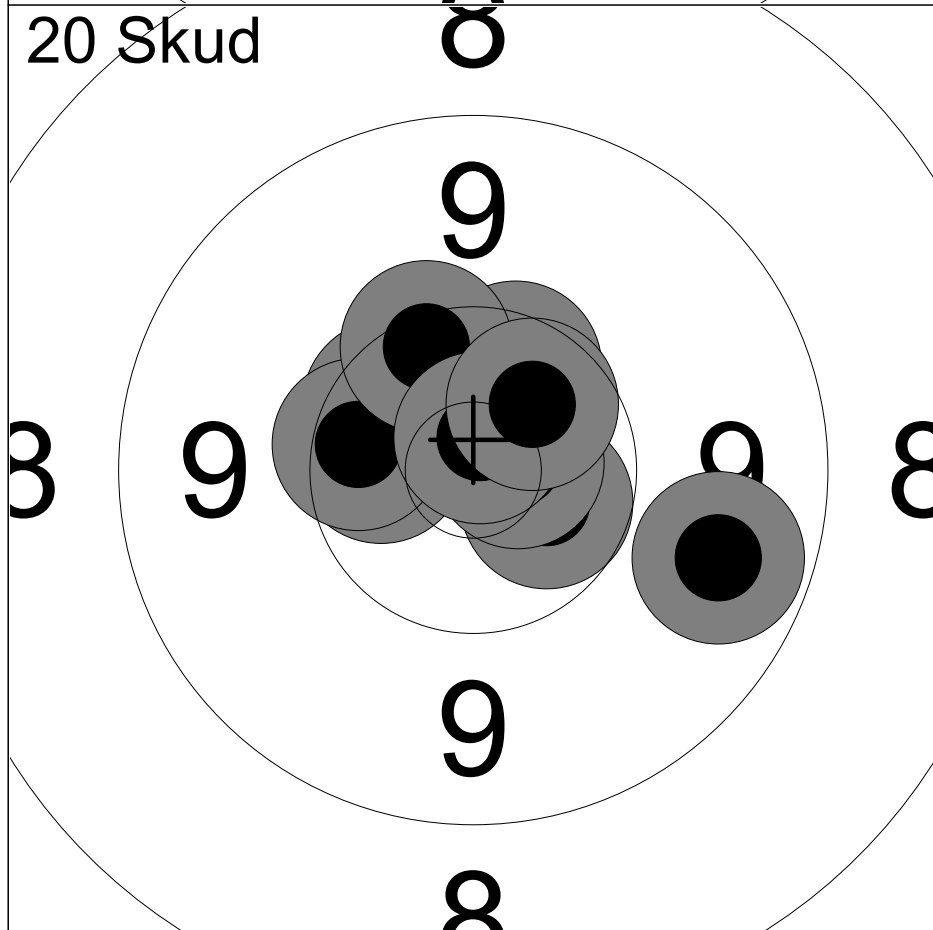

11:	10.5x	←
12:	10.4x	↗
13:	10.4	←
14:	9.7	↘
15:	10.6x	↘
16:	10.4	↗
17:	10.7x	→
18:	10.3	↗
19:	10.8x	↗
20:	10.5x	↗
Serie		99 ( 6x)
Total		197 ( 9x)

Hold <b>16</b>	Skive <b>11</b>	<b>Stine Kongsted</b>	
50m		Frederikssund Skytteforening, I	Å1
09.08.2025		EM 2025	Hanebjerg Skyttecenter
Kommentar		Signatur	

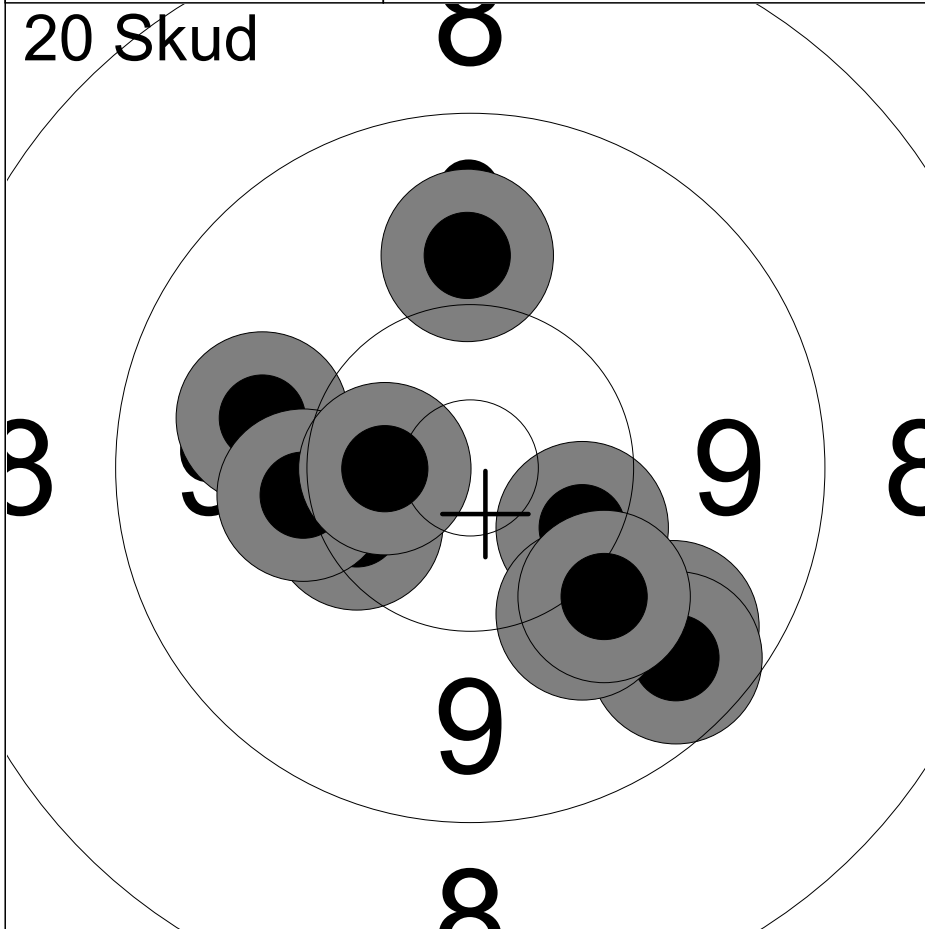

1:	9.9	←
2:	9.9	↑
3:	9.7	↘
4:	10.3	←
5:	10.1	←
6:	10.3	↘
7:	9.6	↘
8:	10.1	↘
9:	10.0	↘
10:	10.5x	←
Serie		96 ( 1x)
Total		96 ( 1x)

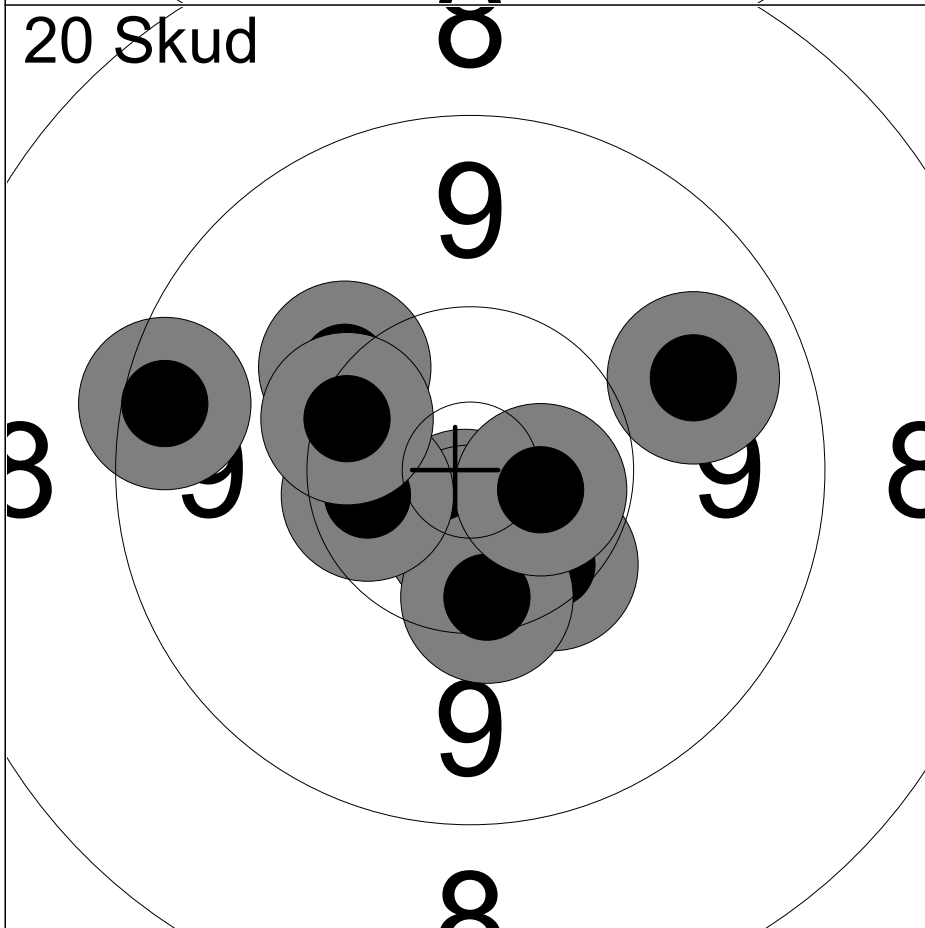

11:	10.3	↘
12:	10.7x	↘
13:	9.8	→
14:	10.7x	↘
15:	10.3	↘
16:	9.4	←
17:	10.4x	←
18:	10.2	↗
19:	10.6x	↘
20:	10.3	←
Serie		98 ( 4x)
Total		194 ( 5x)

Hold <b>16</b>	Skive <b>12</b>	<b>Rasmus Andersen</b>	
50m		Frederikssund Skytteforening, I	ST3
09.08.2025		EM 2025	Hanebjerg Skyttecenter
Kommentar		Signatur	

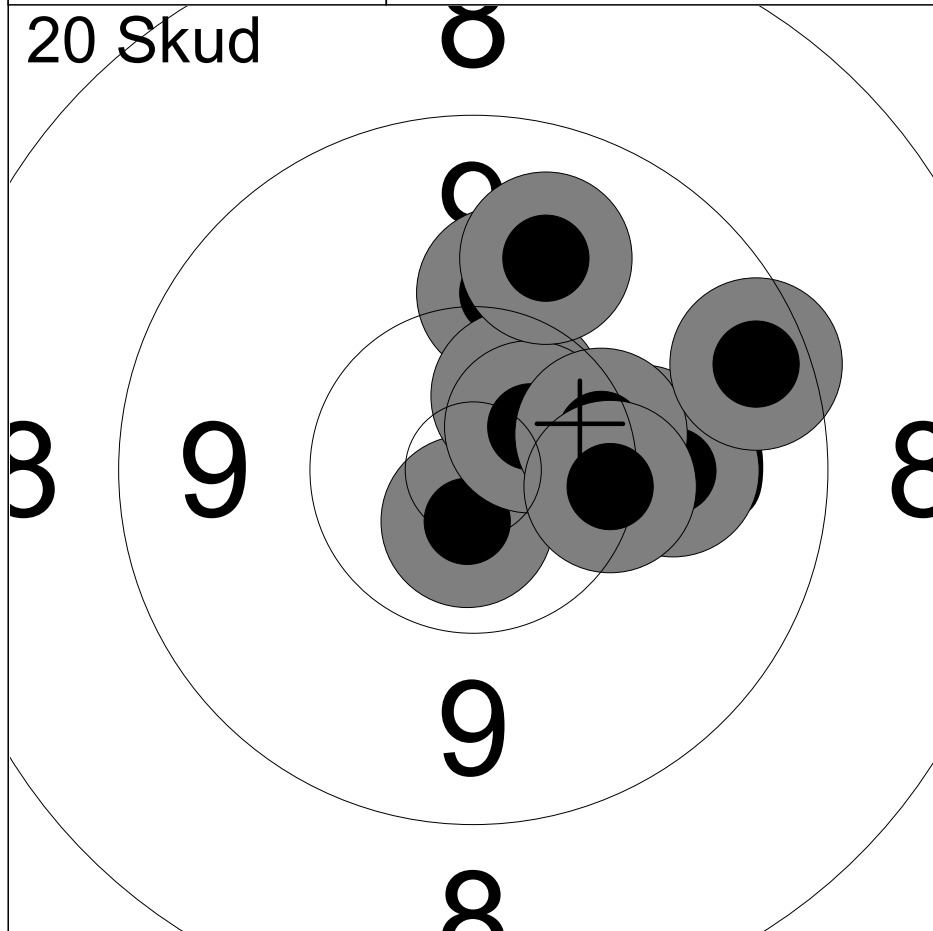

1:	10.1	→
2:	10.1	↑
3:	10.7x	↓
4:	10.0	→
5:	10.5x	↗
6:	10.6x	↗
7:	10.3	→
8:	10.3	→
9:	9.4	→
10:	9.9	↑
Serie		98 ( 3x)
Total		98 ( 3x)

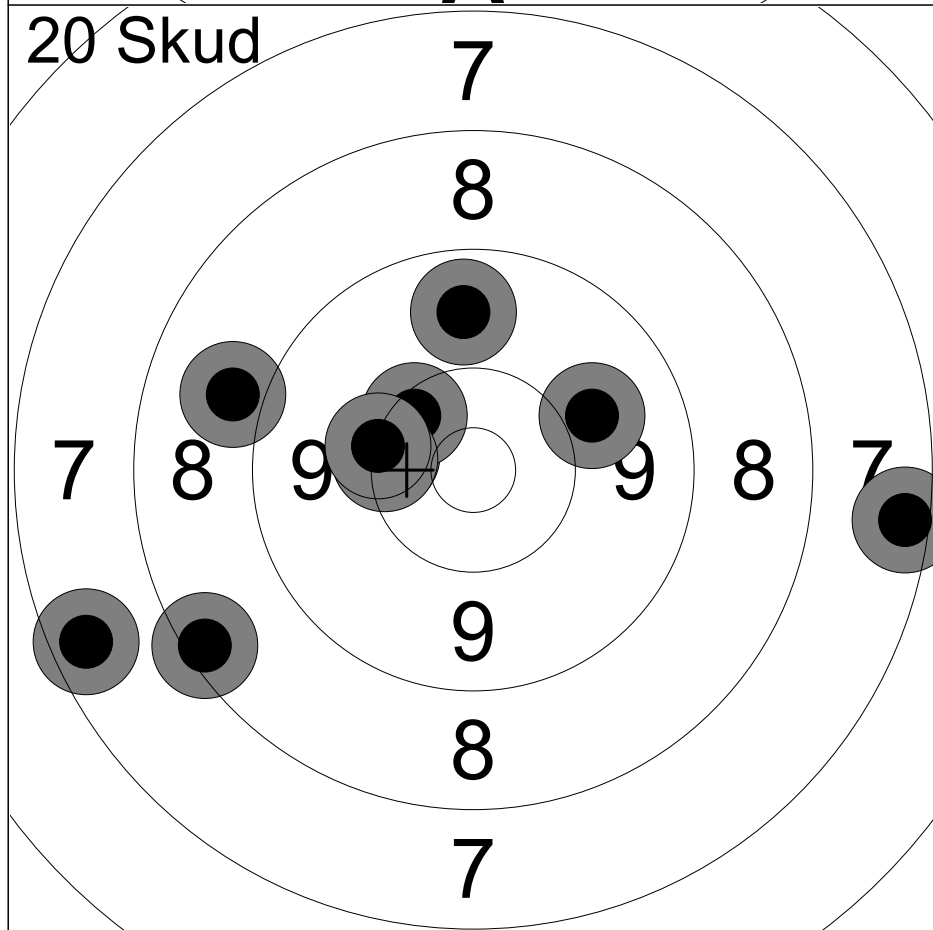

11:	10.3	←
12:	8.3	↙
13:	10.3	↖
14:	9.7	↑
15:	9.9	↗
16:	10.3	←
17:	8.9	↙
18:	7.5	↙
19:	10.2	←
20:	7.4	→
Serie		88 ( 0x)
Total		186 ( 3x)

Hold <b>17</b>	Skive <b>1</b>	<b>Bjarne Binder</b>	
50m		Ølstykke Skytteforening	MÅ1
09.08.2025		EM 2025	Hanebjerg Skyttecenter
Kommentar		Signatur	

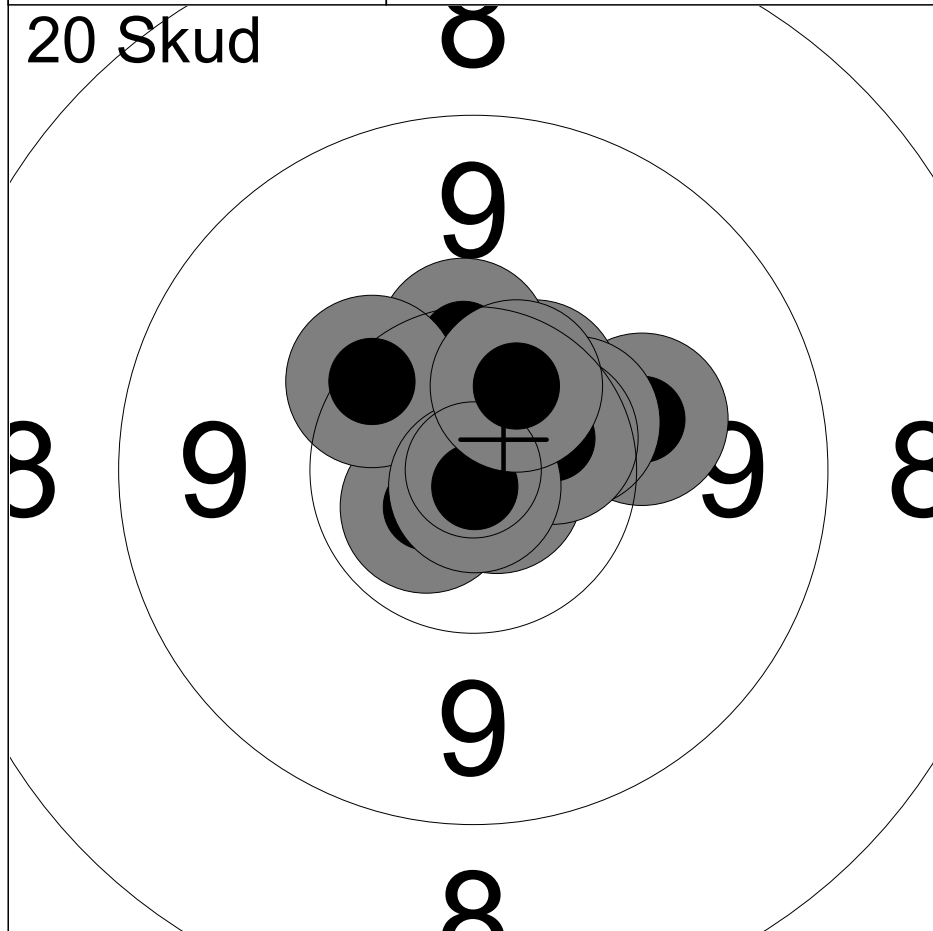

1:	10.1	→
2:	10.4x	↗
3:	10.4	→
4:	10.8x	↘
5:	10.7x	↙
6:	10.3	↑
7:	10.3	↖
8:	10.5x	→
9:	10.9x	↓
10:	10.5x	↗
Serie		100 ( 6x)
Total		100 ( 6x)

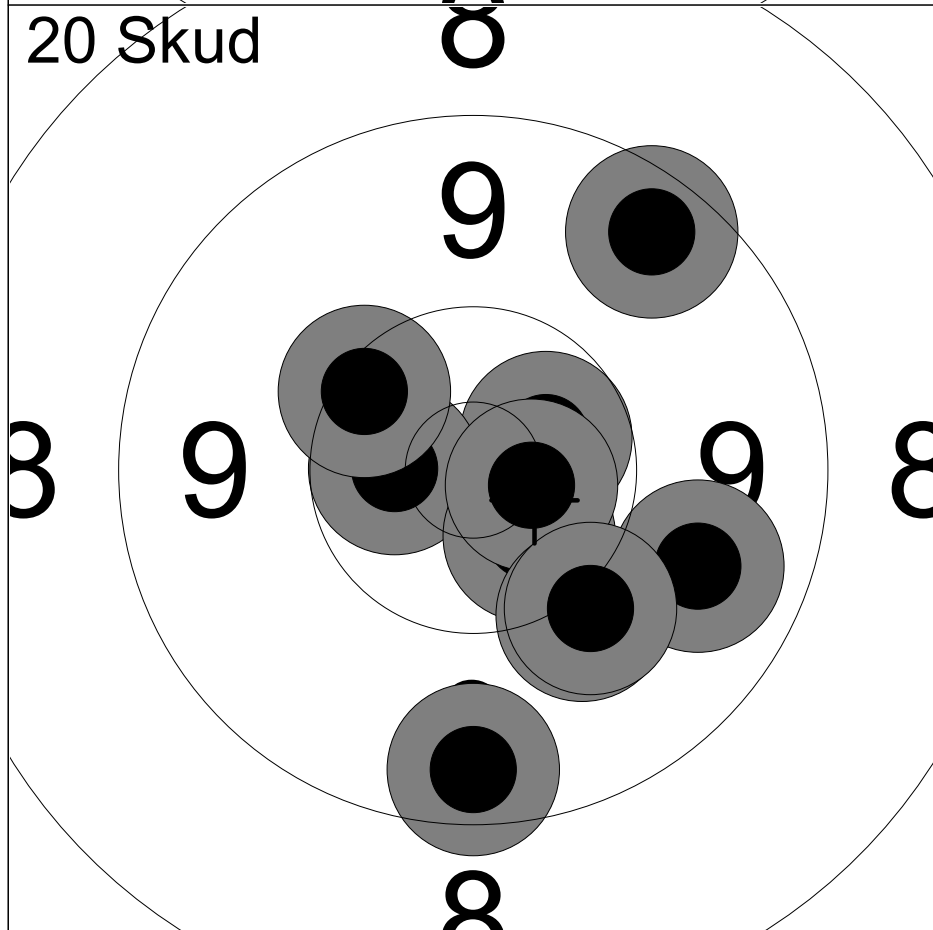

11:	10.6x	→
12:	9.5	↗
13:	10.6x	←
14:	9.5	↓
15:	10.5x	↘
16:	10.7x	↘
17:	10.3	↖
18:	9.7	↘
19:	10.1	↘
20:	10.1	↘
Serie		97 ( 4x)
Total		197 (10x)

Hold <b>17</b>	Skive <b>2</b>	<b>Kasper Mygind</b>	
50m	Ganløse Skytteforening	BK3	
09.08.2025	EM 2025	Hanebjerg Skyttecenter	
Kommentar	Signatur		

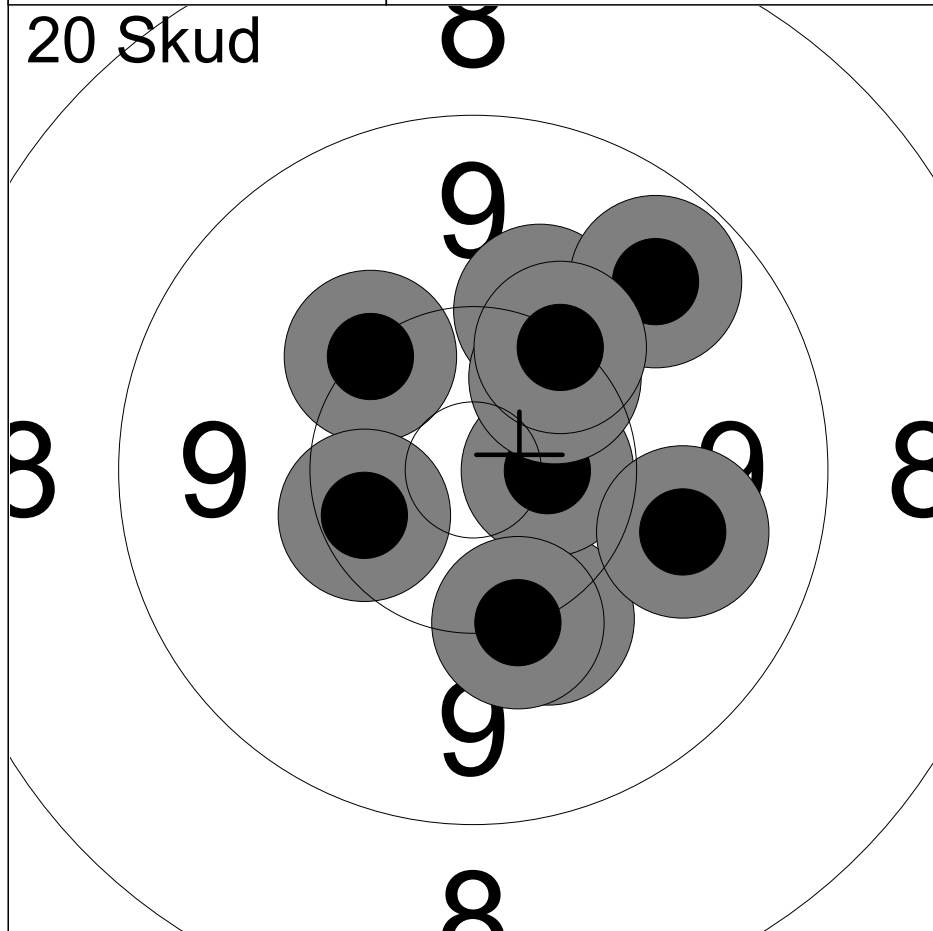

1:	10.2	↖
2:	10.1	↗
3:	10.4	↙
4:	10.1	↘
5:	10.6x	→
6:	10.2	↘
7:	9.7	↗
8:	10.4	↗
9:	10.2	↗
10:	9.9	→
Serie		98 ( 1x)
Total		98 ( 1x)

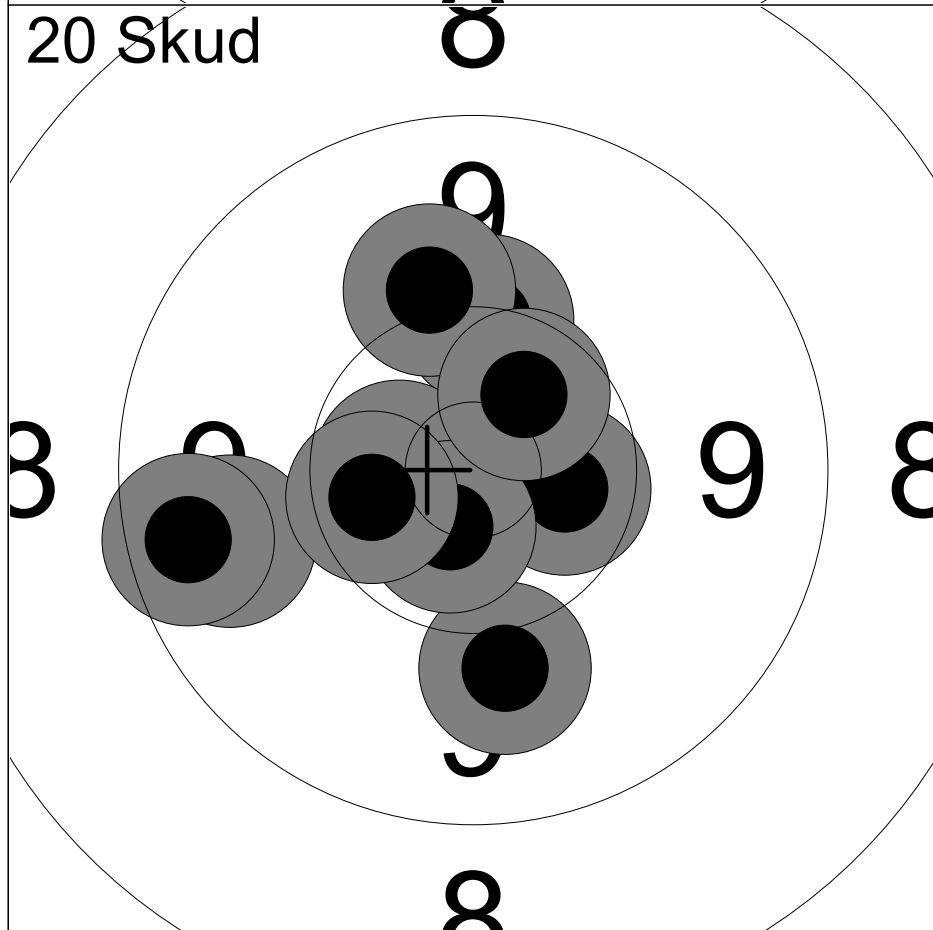

11:	10.2	↑
12:	10.0	↘
13:	10.6x	←
14:	10.5x	→
15:	9.7	←
16:	10.7x	↘
17:	10.1	↗
18:	9.5	←
19:	10.4x	←
20:	10.5x	↗
Serie		98 ( 5x)
Total		196 ( 6x)

Hold <b>17</b>	Skive <b>3</b>	<b>Emmily Brendstrup</b>	
50m		Ganløse Skytteforening	BK3
09.08.2025		EM 2025	Hanebjerg Skyttecenter
Kommentar		Signatur	

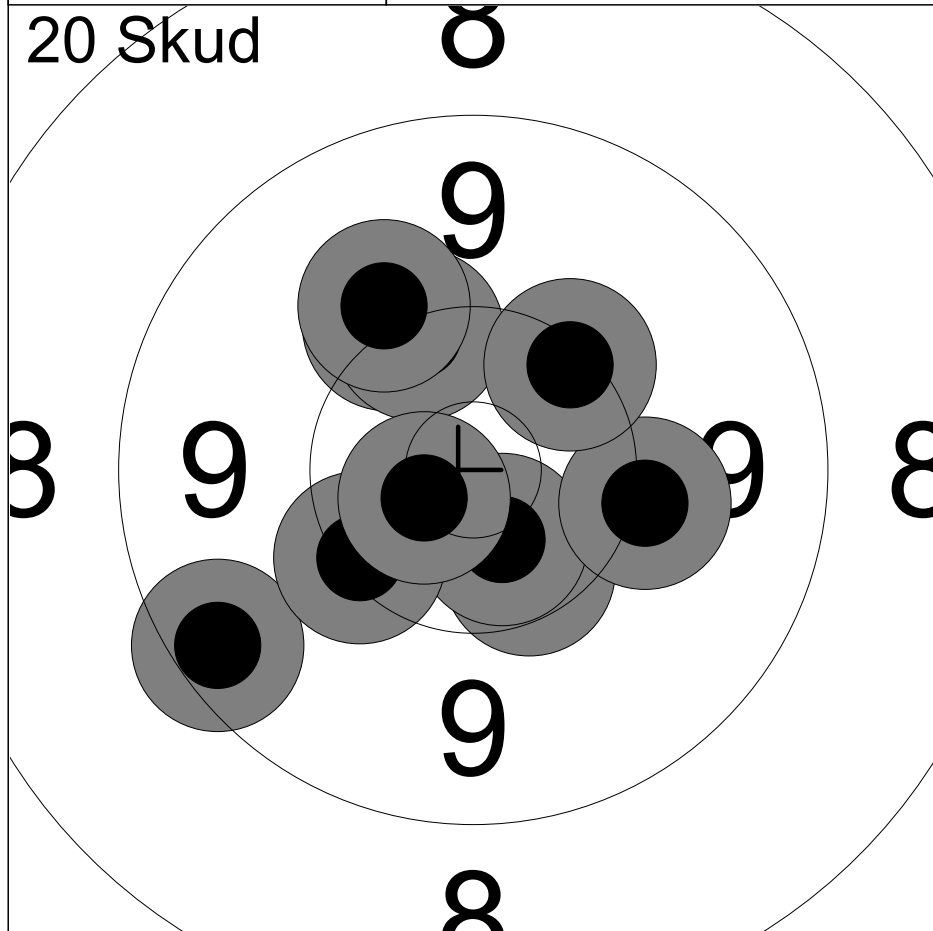

1:	10.1	↗
2:	10.4	↘
3:	9.4	↖
4:	10.6x	↘
5:	10.1	→
6:	10.3	↖
7:	10.2	↗
8:	10.3	↗
9:	10.7x	↖
10:	10.0	↗
Serie		99 ( 2x)
Total		99 ( 2x)

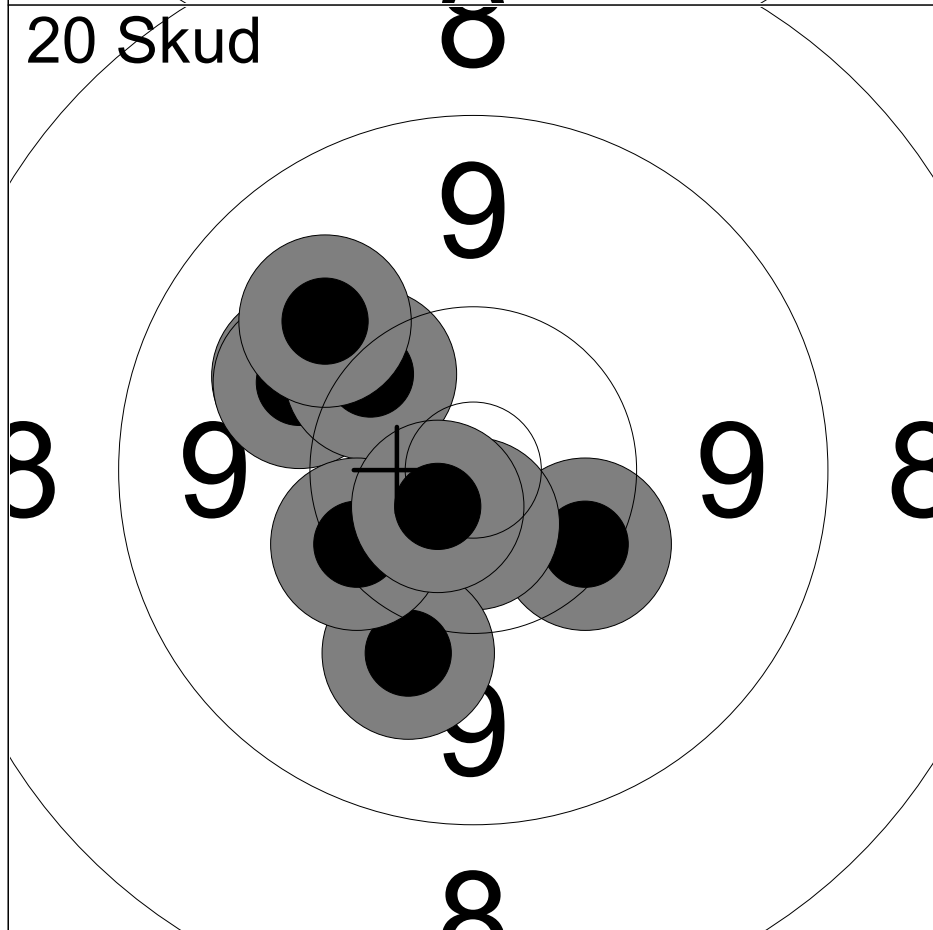

11:	10.0	↖
12:	10.3	↘
13:	10.7x	↓
14:	10.0	↘
15:	10.0	↗
16:	0.0	
17:	10.3	↗
18:	10.3	↖
19:	9.9	↗
20:	10.7x	↘
Serie		89 ( 2x)
Total		188 ( 4x)

Hold <b>17</b>	Skive <b>5</b>	<b>Benjamin Landman</b>	
50m		Kreds 57, Ferslev, Skibby	J2
09.08.2025		EM 2025	Hanebjerg Skyttecenter
Kommentar		Signatur	

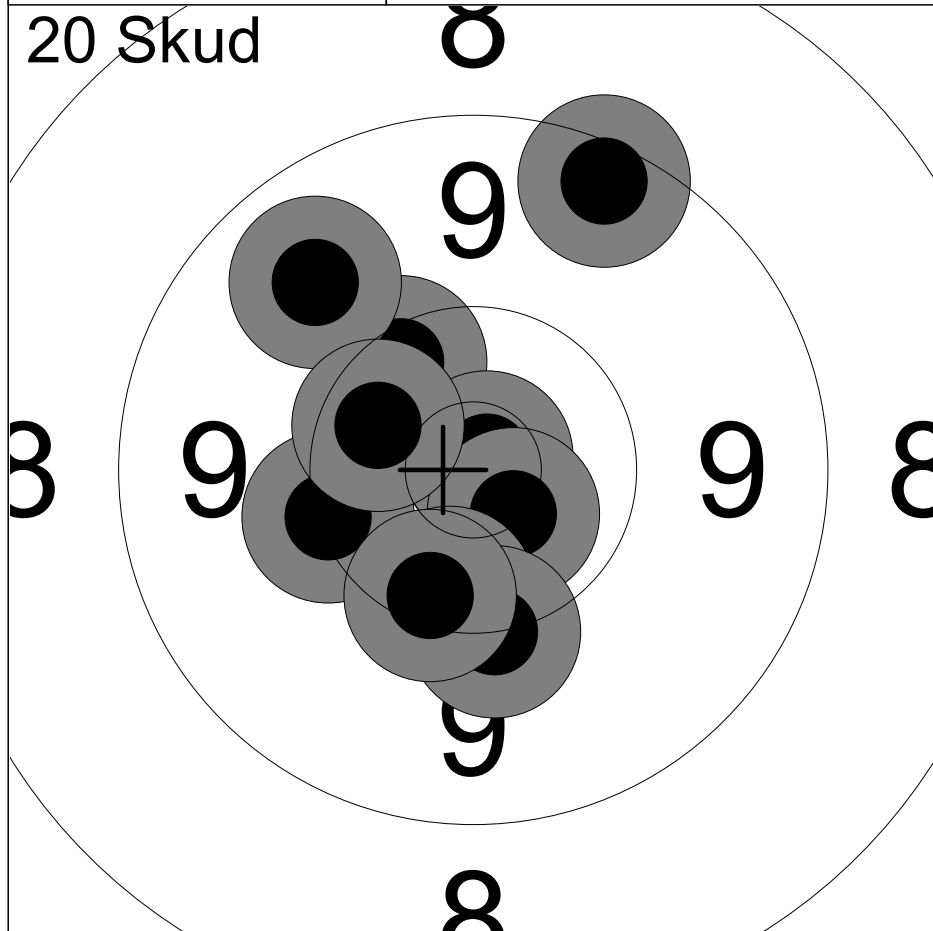

1:	9.4	↗
2:	10.3	↗
3:	10.9x	↗
4:	9.7	↗
5:	10.2	↖
6:	10.7x	↘
7:	10.3	↘
8:	10.4x	↖
9:	10.2	↘
10:	10.3	↘
Serie		98 ( 3x)
Total		98 ( 3x)

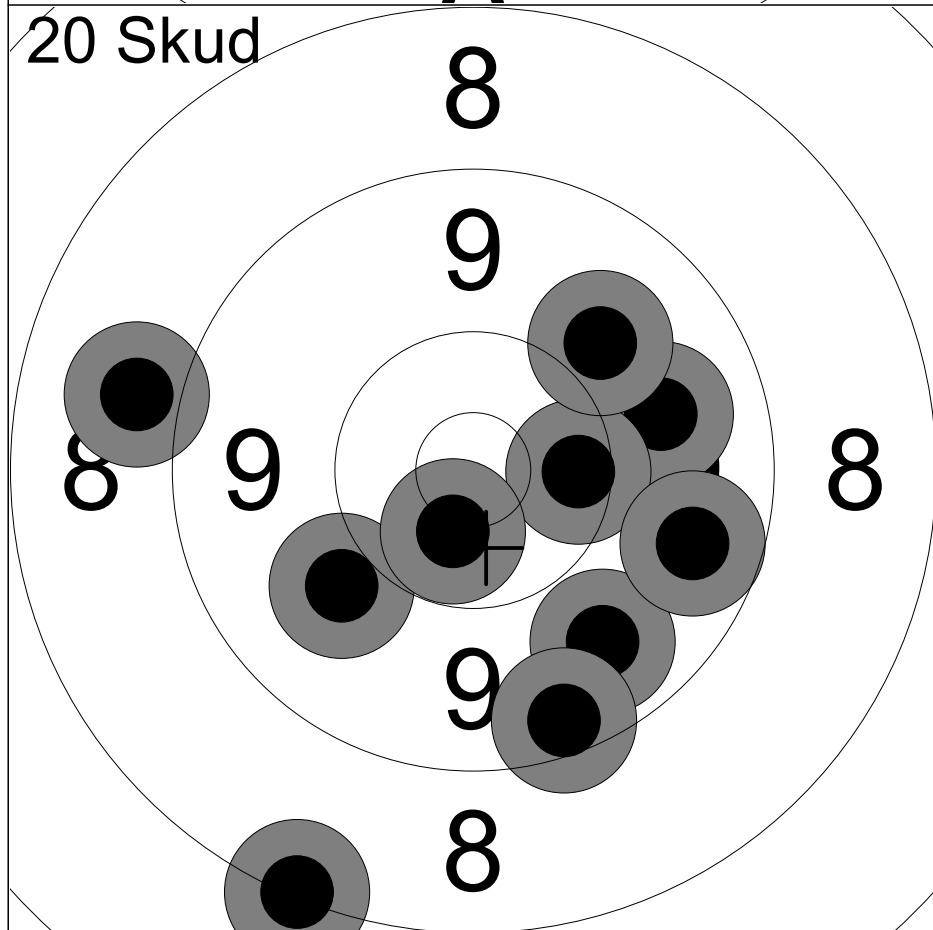

11:	9.8	→
12:	9.7	↘
13:	8.9	↖
14:	9.9	↖
15:	9.4	↘
16:	10.4	→
17:	10.6x	↘
18:	8.2	↘
19:	9.9	↗
20:	9.6	→
Serie		90 ( 1x)
Total		188 ( 4x)

Hold <b>17</b>	Skive <b>8</b>	<b>Sara Aaslev Noerager Bay</b>	
50m	Ølstykke Skytteforening	ST2	
09.08.2025	EM 2025	Hanebjerg Skyttecenter	
Kommentar	Signatur		

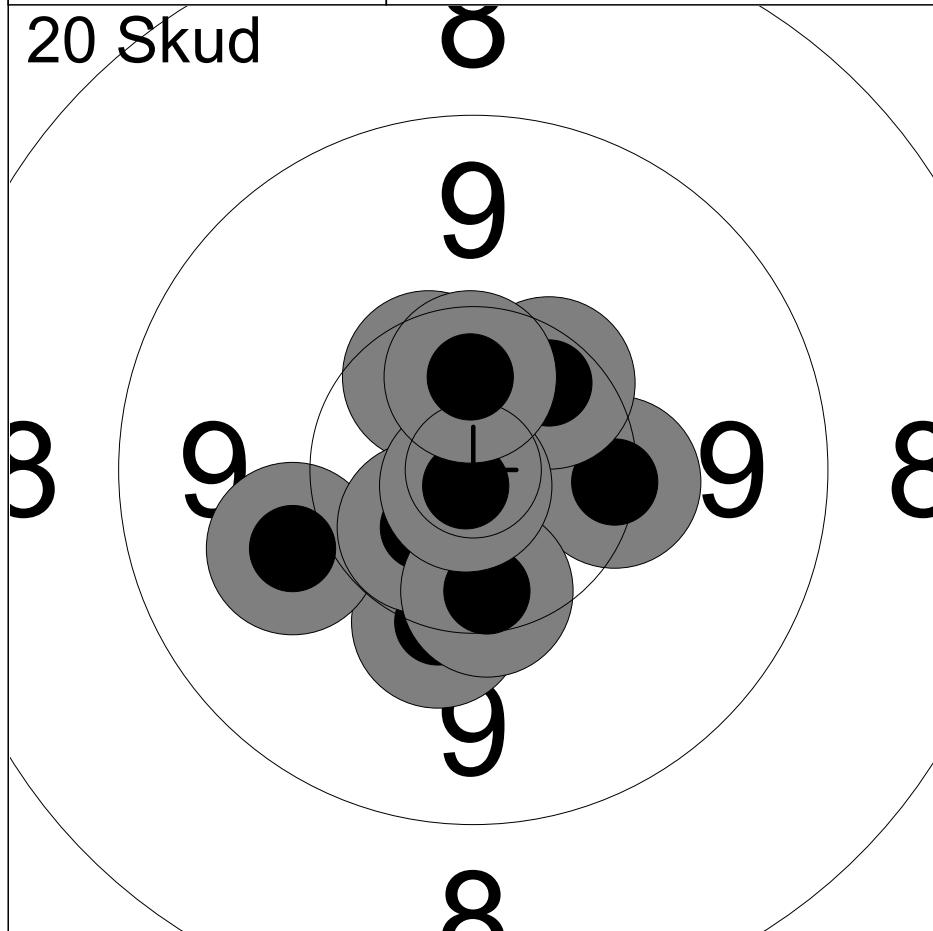

1:	10.5x	↗
2:	10.5x	↖
3:	10.3	→
4:	10.2	↓
5:	10.0	↙
6:	10.4	↗
7:	10.6x	↙
8:	10.4	↓
9:	10.9x	↙
10:	10.5x	↑
Serie		100 ( 5x)
Total		100 ( 5x)

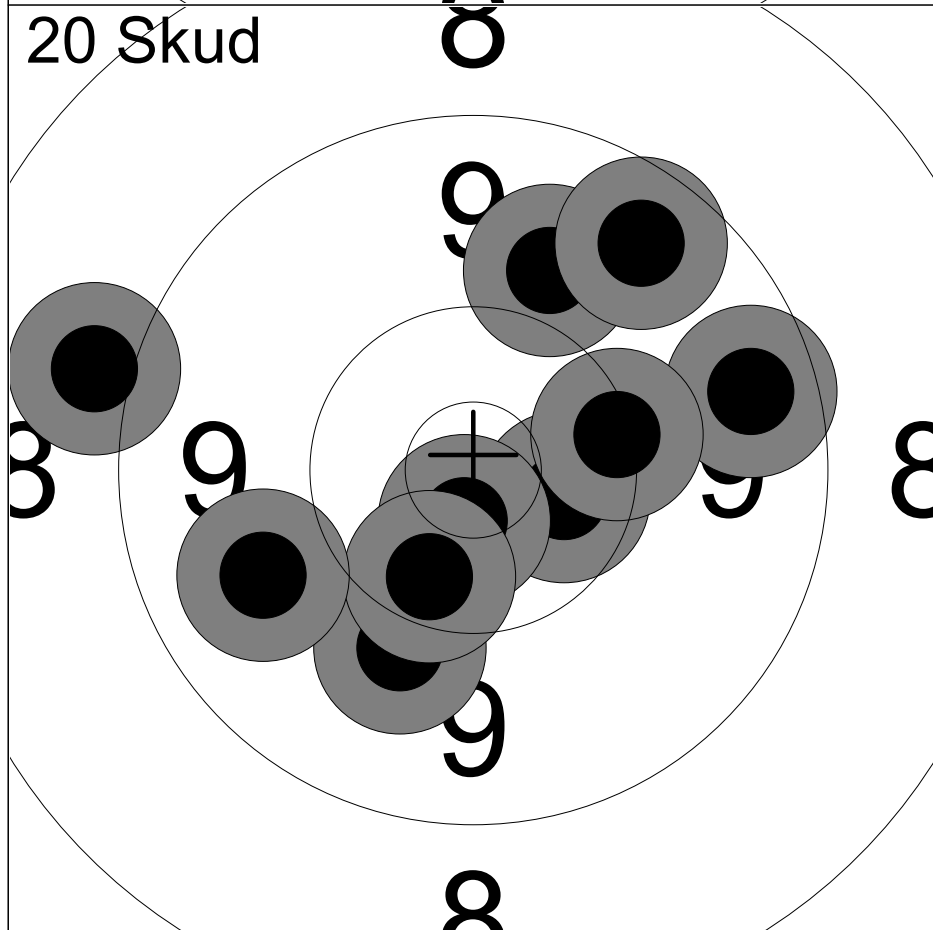

11:	10.0	↓
12:	9.5	→
13:	10.5x	→
14:	9.9	↗
15:	10.7x	↓
16:	10.4	↙
17:	10.2	→
18:	9.0	↙
19:	9.8	↙
20:	9.6	↗
Serie		95 ( 2x)
Total		195 ( 7x)

Hold <b>17</b>	Skive <b>12</b>	<b>Ida Aaslev Noerager Bay</b>	
50m		Ølstykke Skytteforening	ST2
09.08.2025		EM 2025	Hanebjerg Skyttecenter
Kommentar		Signatur	

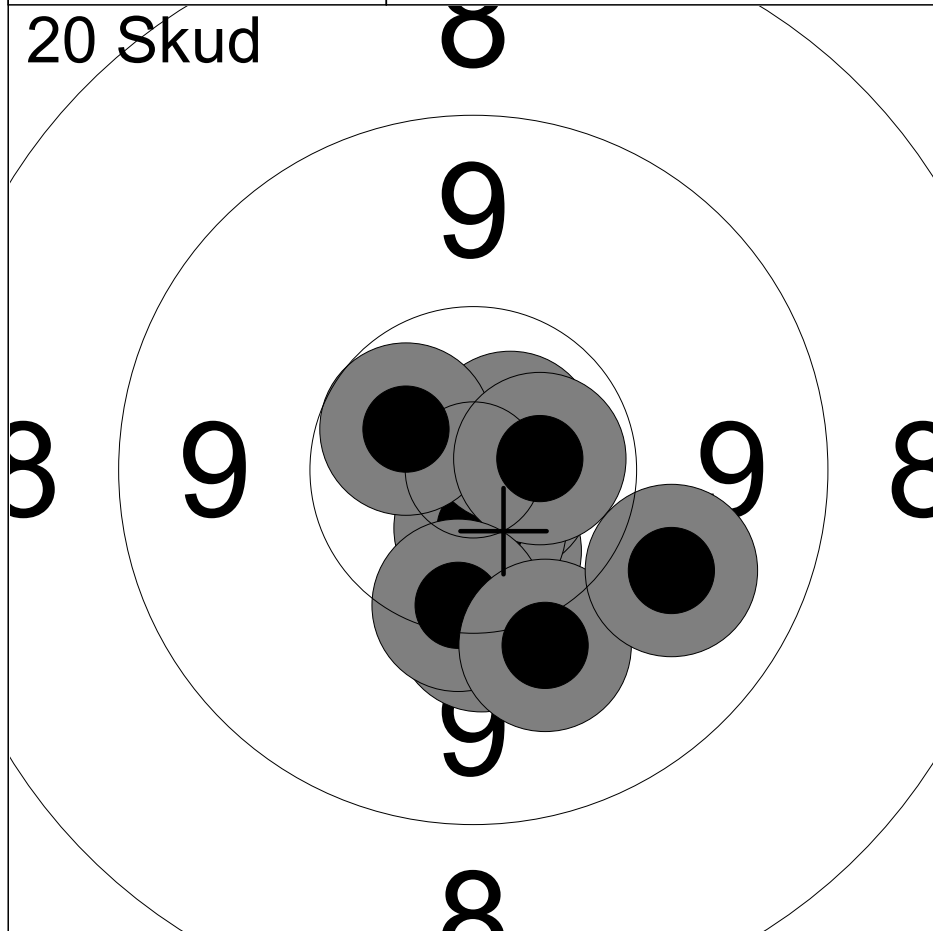

1:	10.2	↓
2:	10.5x	↓
3:	10.8x	↘
4:	10.7x	↓
5:	10.7x	↗
6:	10.6x	↖
7:	10.6x	→
8:	10.3	↓
9:	10.0	↓
10:	9.9	↘
Serie		99 ( 6x)
Total		99 ( 6x)

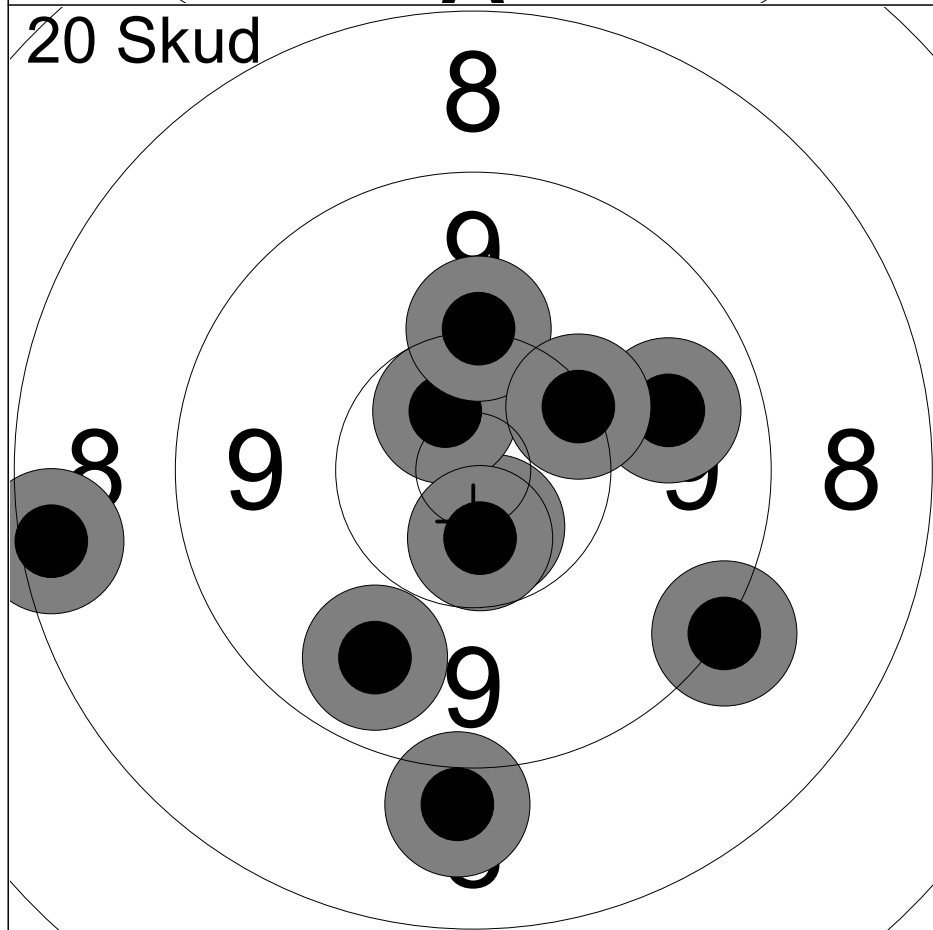

11:	9.8	→
12:	10.6x	↓
13:	9.2	↘
14:	8.9	↓
15:	8.4	←
16:	10.6x	↖
17:	10.1	↑
18:	10.6x	↓
19:	10.2	↗
20:	9.7	↙
Serie		93 ( 3x)
Total		192 ( 9x)

Hold <b>18</b>	Skive <b>1</b>	<b>Agnete Soerensen</b>	
50m	Frederikssund Skytteforening, I	Å1	
09.08.2025	EM 2025	Hanebjerg Skyttecenter	
Kommentar	Signatur		

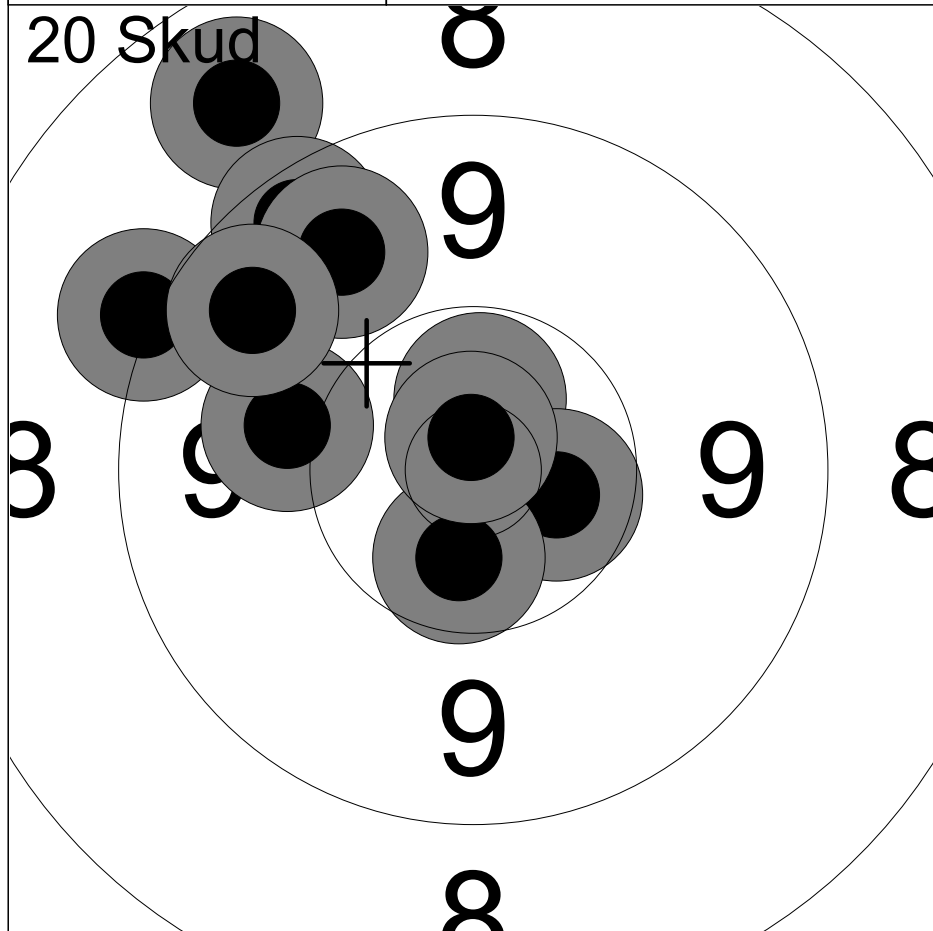

1:	10.6x	↑
2:	10.5x	→
3:	9.1	↗
4:	8.7	↗
5:	10.5x	↘
6:	10.0	←
7:	9.4	↗
8:	10.8x	↑
9:	9.7	↗
10:	9.6	↗
Serie		94 ( 4x)
Total		94 ( 4x)

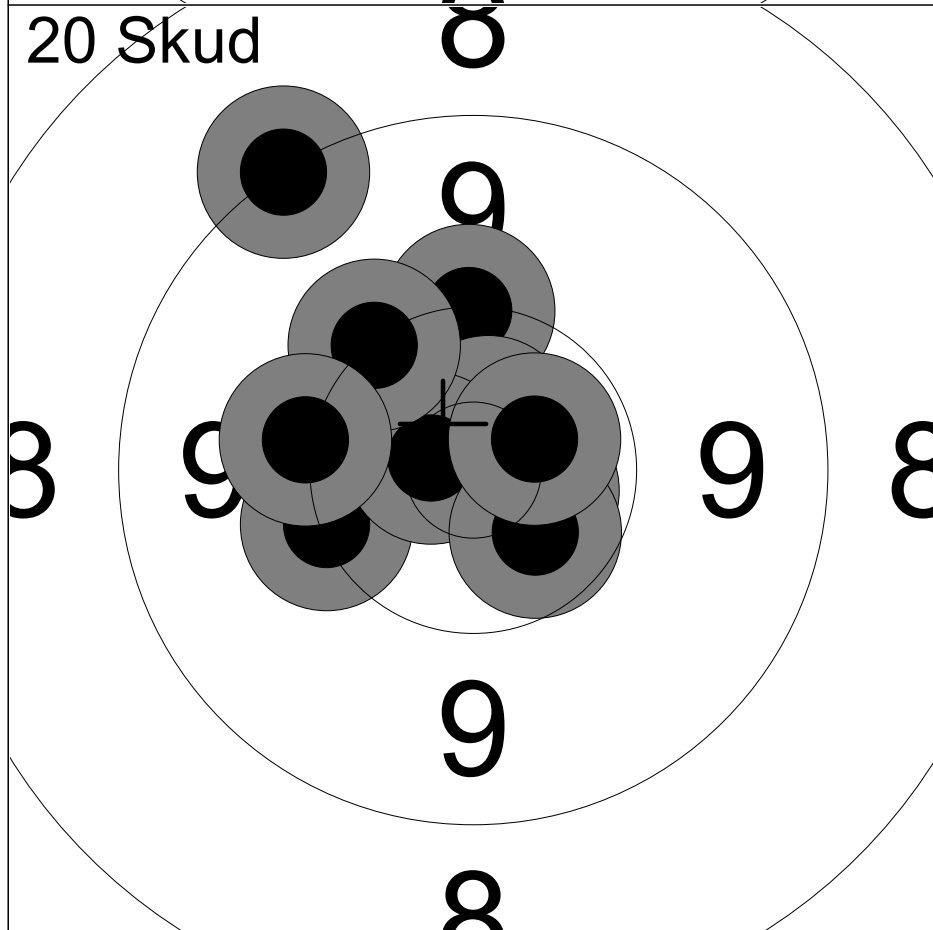

11:	9.2	↗
12:	10.6x	→
13:	10.2	↑
14:	10.2	←
15:	10.7x	↗
16:	10.7x	←
17:	10.5x	↘
18:	10.2	↗
19:	10.6x	↗
20:	10.1	←
Serie		99 ( 5x)
Total		193 ( 9x)

Hold <b>18</b>	Skive <b>3</b>	<b>Palle Kofoed</b>	
50m		Østerlars Skytteforening	Å1
09.08.2025		EM 2025	Hanebjerg Skyttecenter
Kommentar		Signatur	

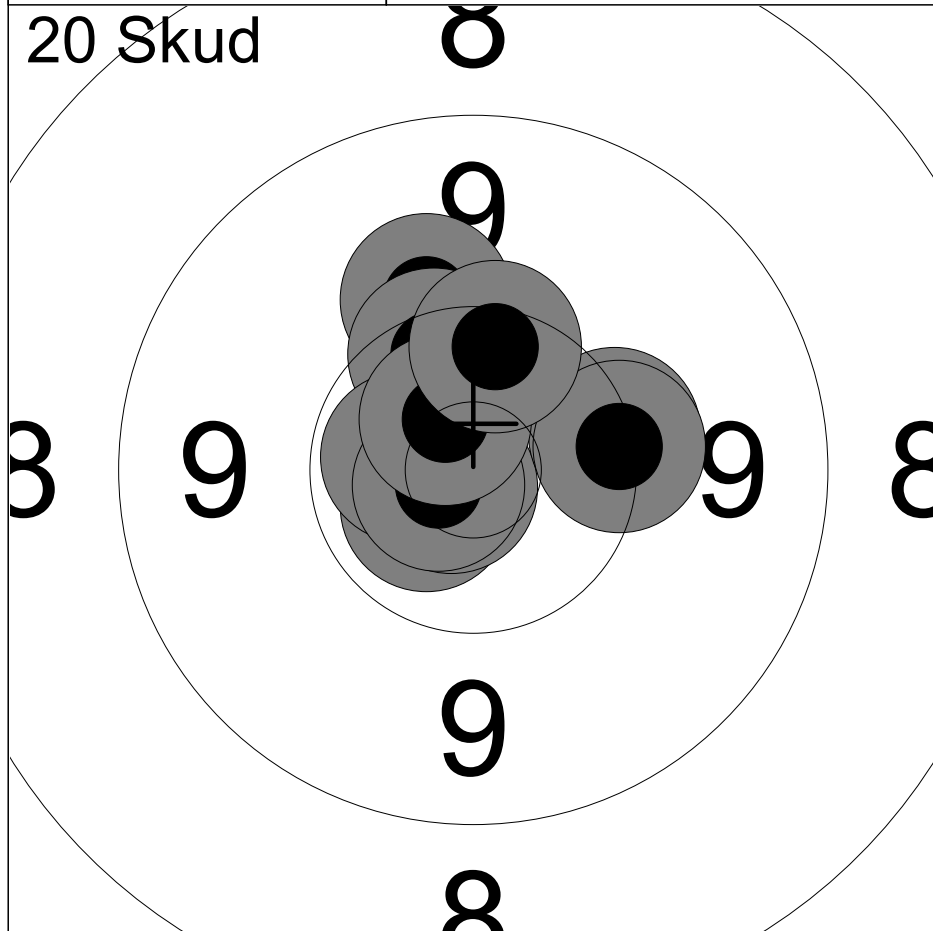

1:	10.1	↗
2:	10.7x	↖
3:	10.4	↗
4:	10.6x	↖
5:	10.8x	↖
6:	10.2	→
7:	10.8x	↖
8:	10.7x	↗
9:	10.2	→
10:	10.3	↗
Serie		100 ( 5x)
Total		100 ( 5x)

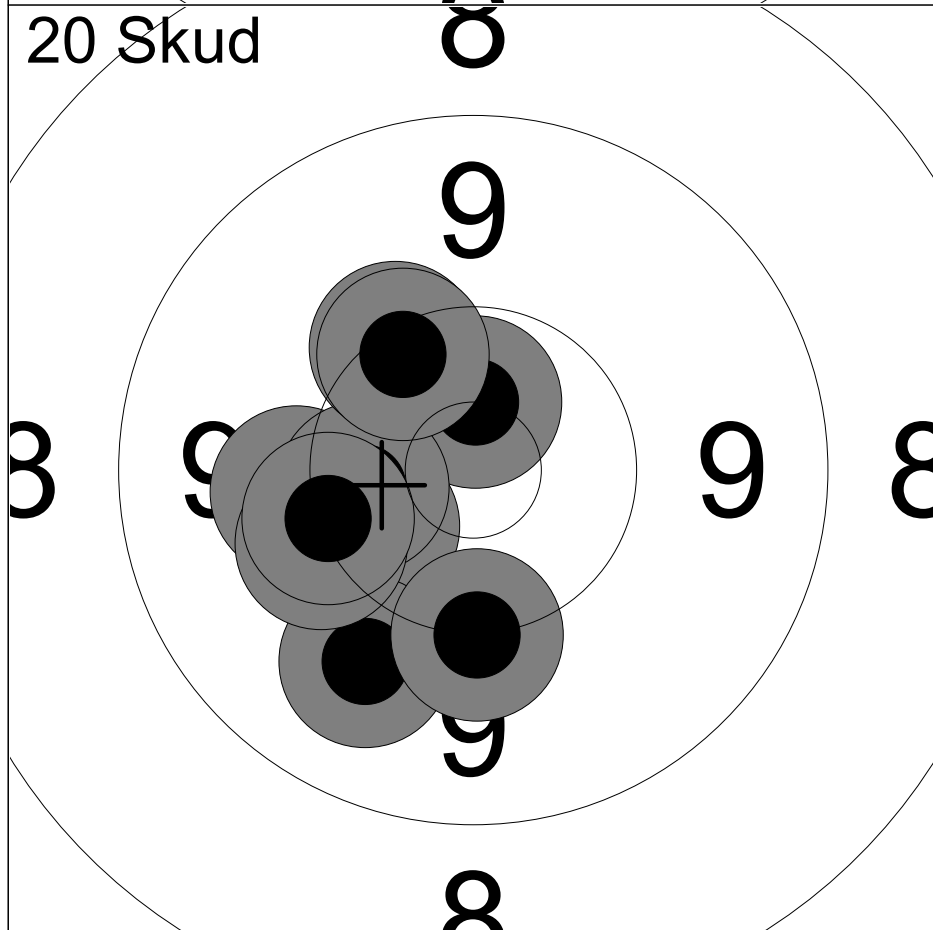

11:	10.1	↖
12:	10.6x	↗
13:	10.4	↖
14:	9.9	↖
15:	10.4	↖
16:	10.1	↖
17:	10.2	↓
18:	10.2	↗
19:	10.2	↖
20:	10.3	↗
Serie		99 ( 1x)
Total		199 ( 6x)

Hold <b>18</b>	Skive <b>4</b>	<b>Freya Kofoed</b>		
50m	Østerlars Skytteforening		ST2	
09.08.2025	EM 2025	Hanebjerg Skyttecenter		
Kommentar	Signatur			

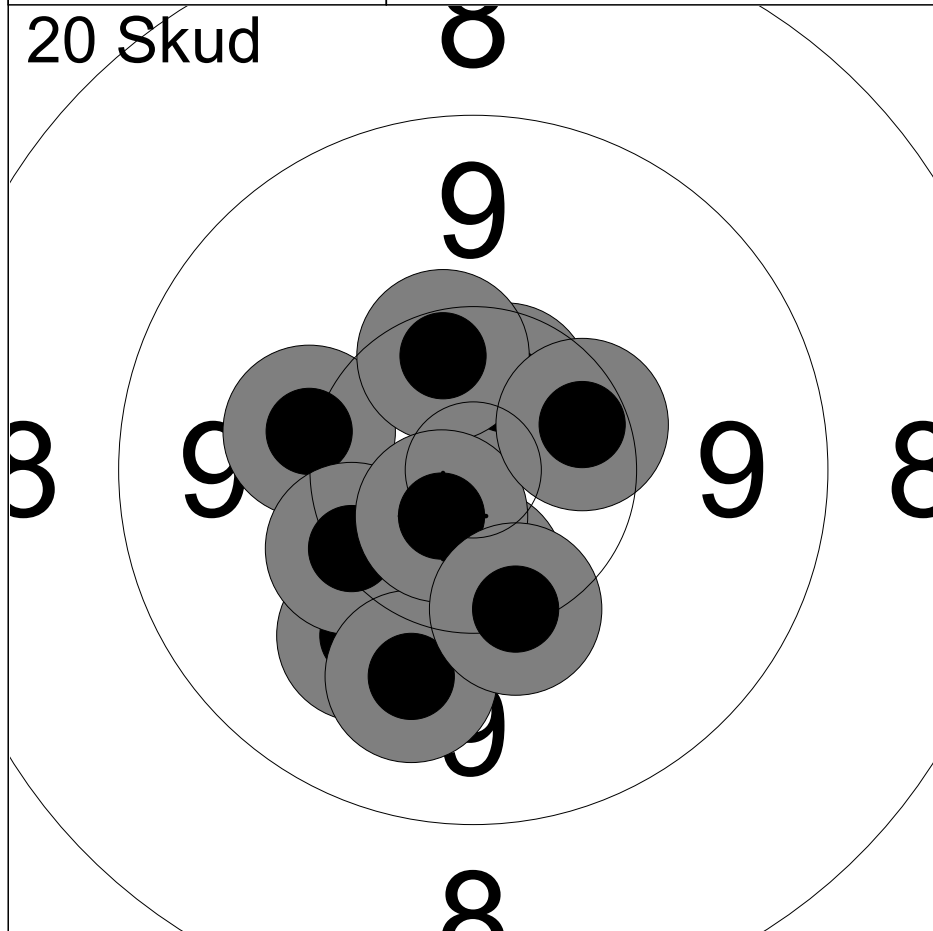

1:	10.4x	↓
2:	10.5x	↗
3:	10.1	↖
4:	10.0	↙
5:	10.4	↗
6:	10.2	↖
7:	9.9	↓
8:	10.7x	↙
9:	10.4	↗
10:	10.2	↓
Serie		99 ( 3x)
Total		99 ( 3x)

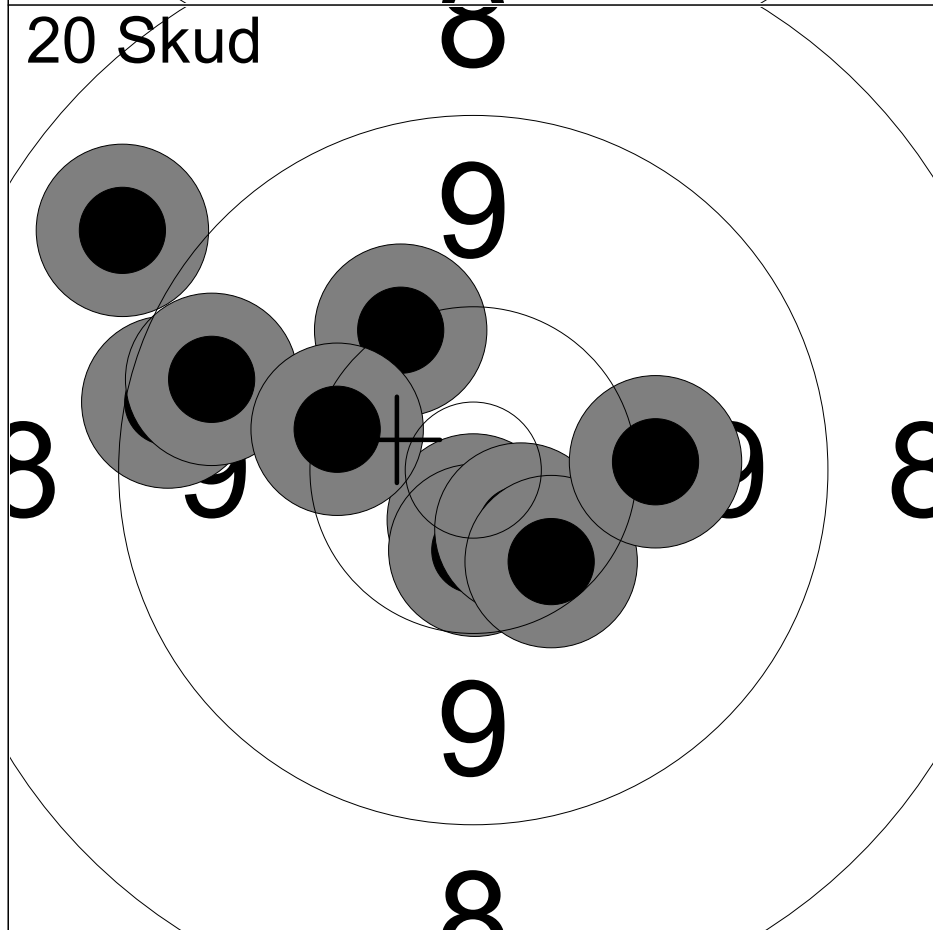

11:	10.7x	↓
12:	10.6x	↓
13:	10.2	↗
14:	10.6x	↙
15:	10.4	↙
16:	10.1	→
17:	8.8	↗
18:	9.4	↖
19:	9.6	↖
20:	10.3	↖
Serie		96 ( 3x)
Total		195 ( 6x)

Hold <b>18</b>	Skive <b>5</b>	<b>Kean Kofoed Noerskov</b>	
50m	Frederikssund Skytteforening, I	MÅ2	
09.08.2025	EM 2025	Hanebjerg Skyttecenter	
Kommentar	Signatur		

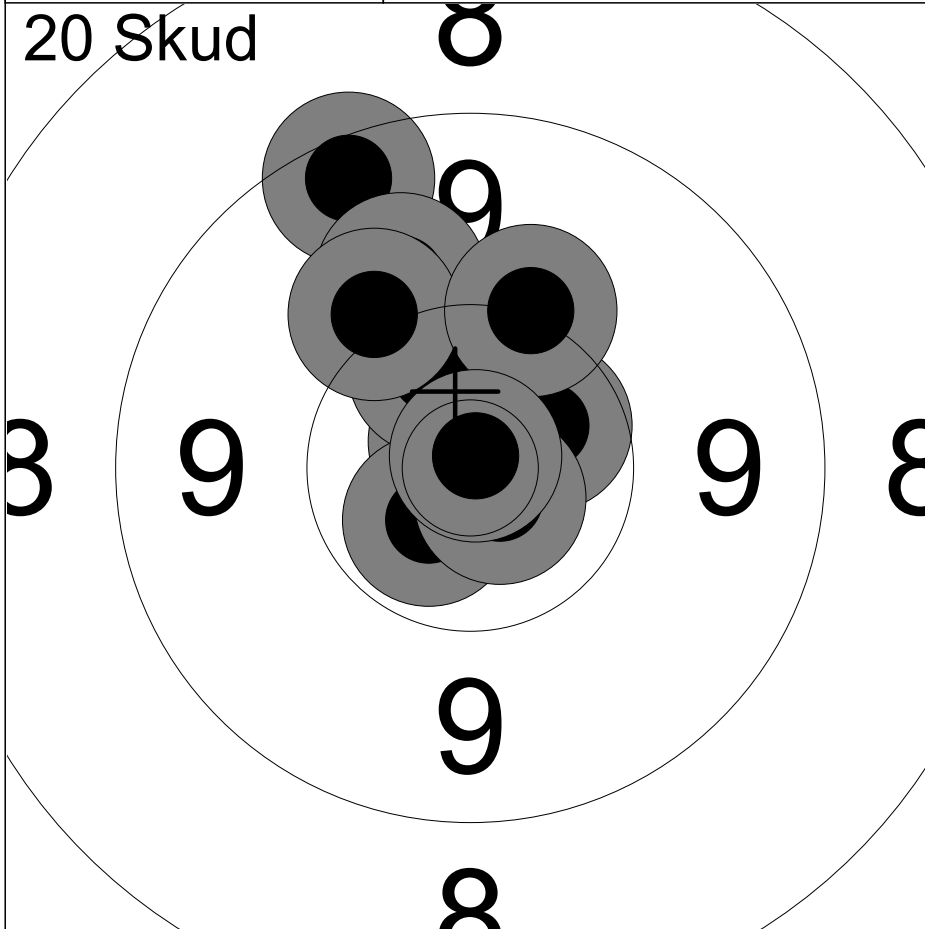

1:	9.4	↗
2:	10.8x	↗
3:	10.4x	↗
4:	10.0	↗
5:	10.6x	↙
6:	10.1	↗
7:	10.5x	↗
8:	10.1	↗
9:	10.7x	↘
10:	10.9x	↗
Serie	99 ( 6x)	
Total	99 ( 6x)	

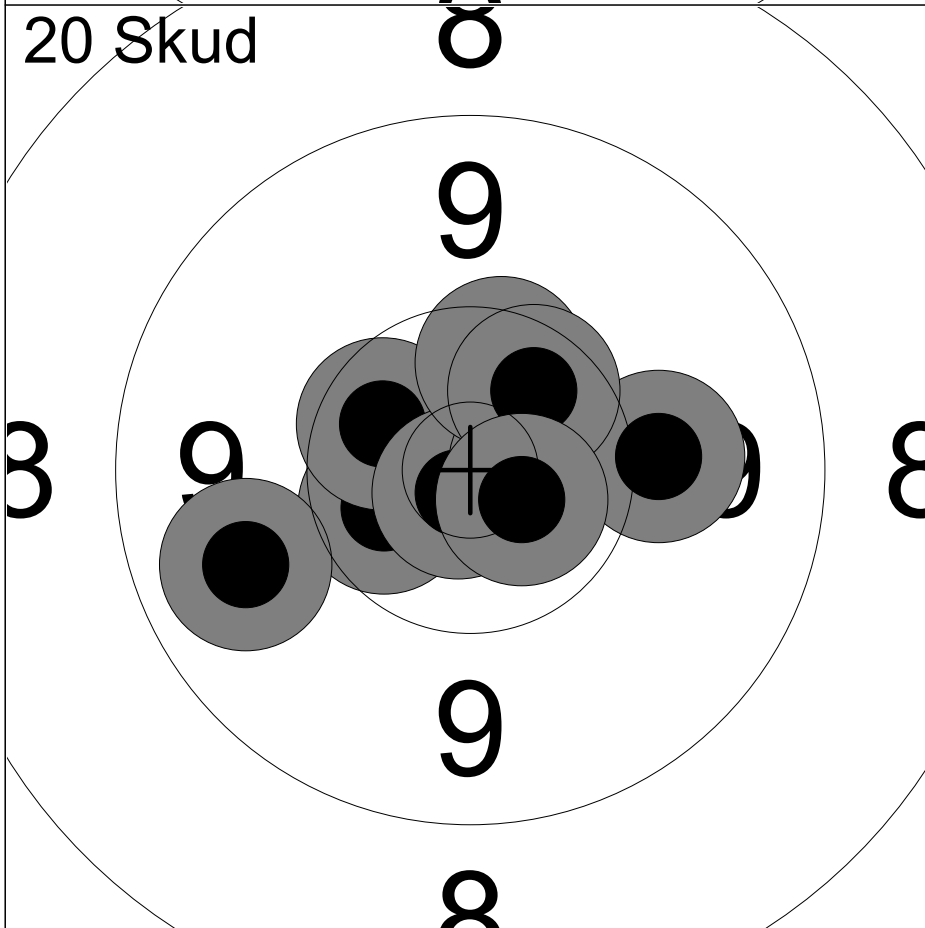

11:	10.5x	↖
12:	10.5x	↖
13:	10.8x	↗
14:	10.8x	↙
15:	10.6x	→
16:	10.4	↗
17:	10.0	→
18:	10.5x	↗
19:	9.8	↖
20:	10.7x	↘
Serie	99 ( 7x)	
Total	198 (13x)	

Hold <b>18</b>	Skive <b>8</b>	<b>Theodor Hejnfelt</b>	
50m	Kreds 57, Ferslev, Skibby	BK2	
09.08.2025	EM 2025	Hanebjerg Skyttecenter	
Kommentar	Signatur		

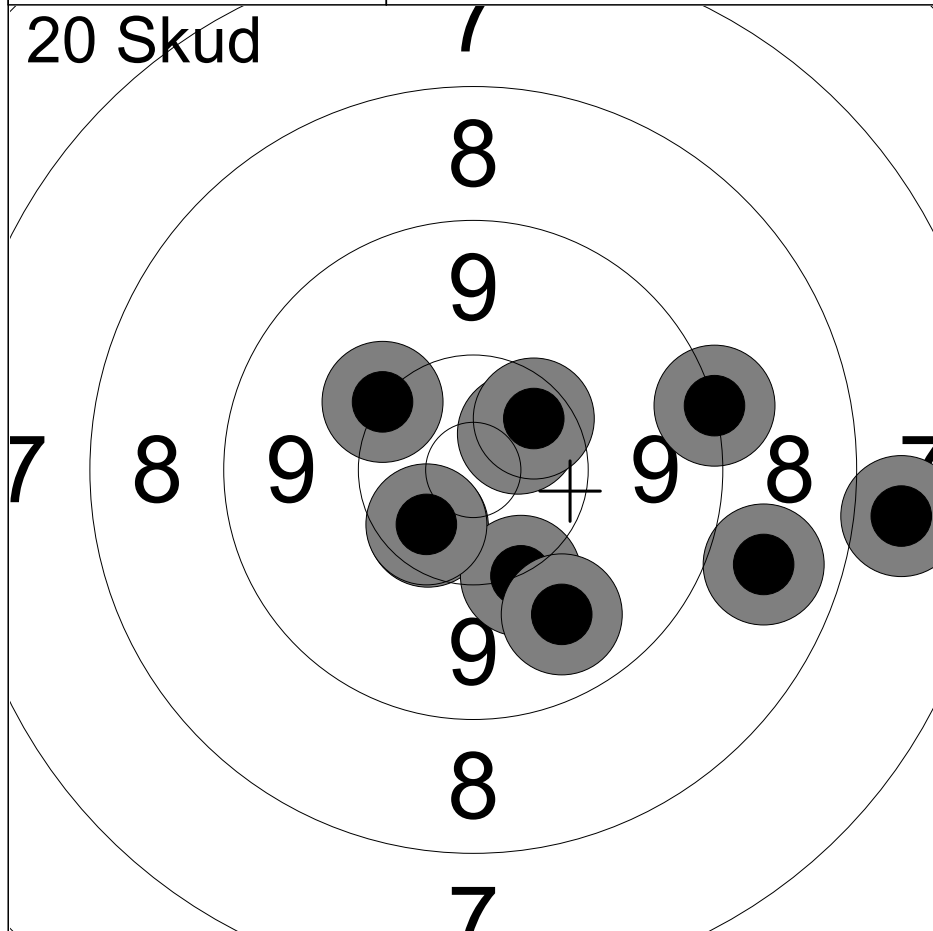

1:	9.2	→
2:	8.8	→
3:	10.5x	↙
4:	10.2	↗
5:	7.8	→
6:	10.1	↘
7:	10.6x	↗
8:	9.8	↘
9:	10.5x	↙
10:	10.4	↗
Serie	93 ( 3x)	
Total	93 ( 3x)	

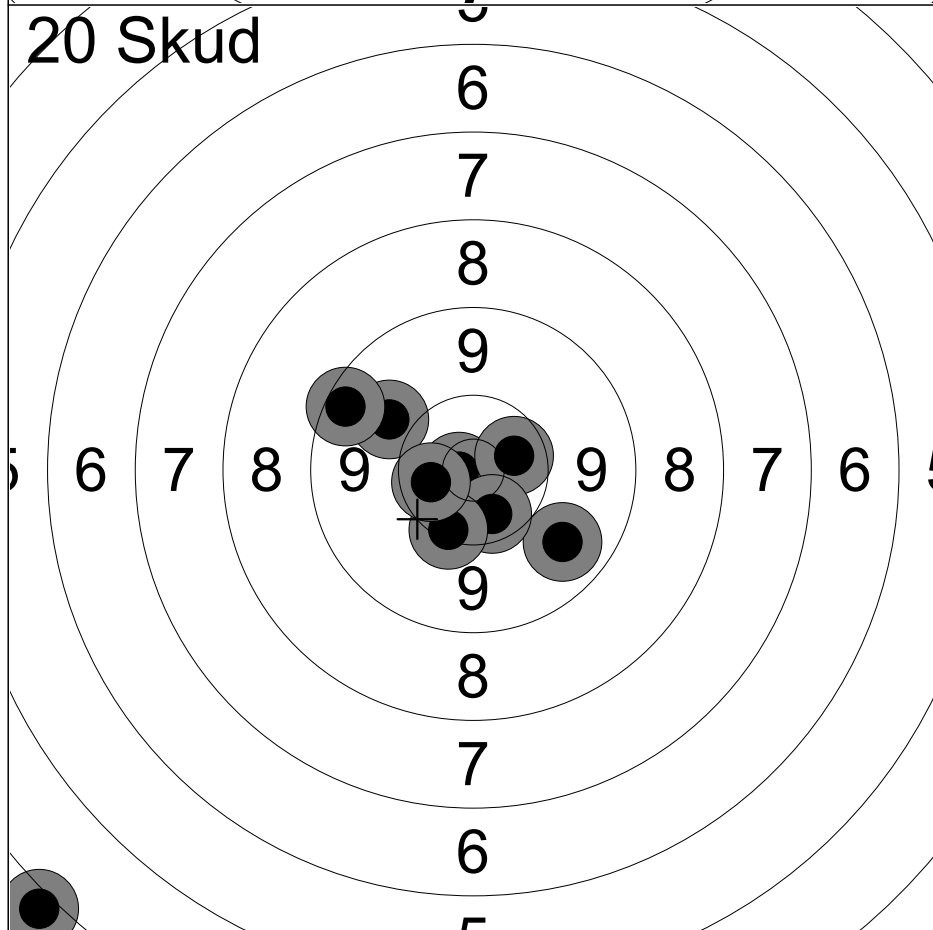

11:	9.9	↖
12:	9.7	↘
13:	10.5x	↙
14:	4.0	↘
15:	10.8x	←
16:	10.5x	→
17:	10.4x	↘
18:	9.4	↖
19:	10.3	↘
20:	10.5x	←
Serie	91 ( 5x)	
Total	184 ( 8x)	

Hold <b>18</b>	Skive <b>10</b>	<b>Kim Noerager Bay</b>	
50m		Egedal Skytteforening	ST2
09.08.2025		EM 2025	Hanebjerg Skyttecenter
Kommentar		Signatur	

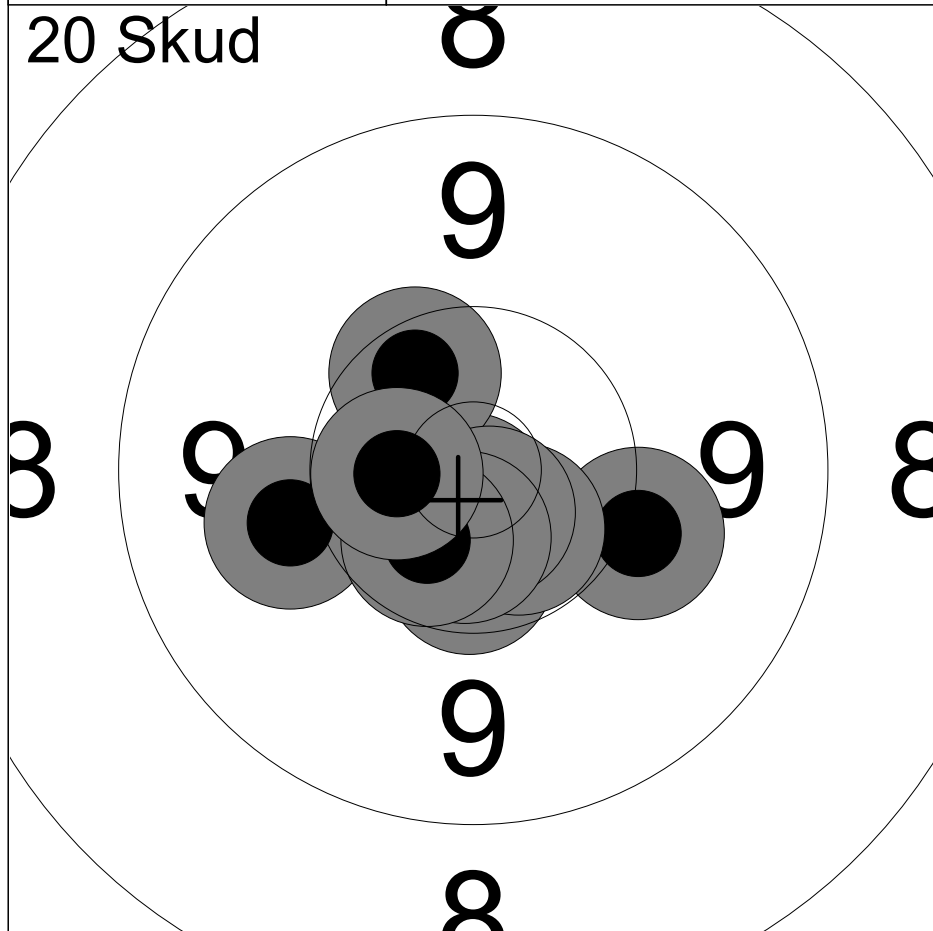

1:	10.8x	↘
2:	10.5x	↘
3:	10.4	↗
4:	10.1	↘
5:	10.6x	↘
6:	10.7x	↘
7:	10.0	↖
8:	10.6x	↘
9:	10.5x	↘
10:	10.6x	↖
Serie		100 ( 7x)
Total		100 ( 7x)

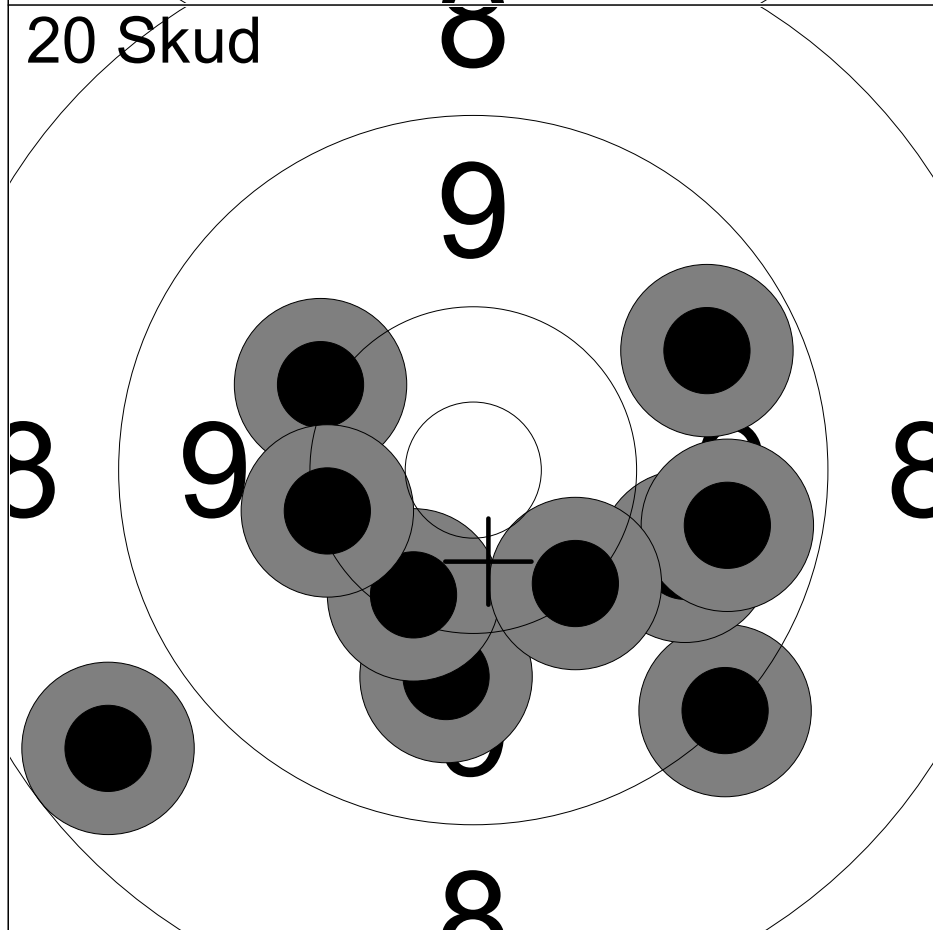

11:	9.7	↗
12:	8.6	↖
13:	9.2	↘
14:	9.8	↘
15:	10.1	↗
16:	9.7	↘
17:	9.9	↘
18:	10.3	↘
19:	10.2	↖
20:	10.2	↘
Serie		93 ( 0x)
Total		193 ( 7x)

Hold <b>18</b>	Skive <b>11</b>	<b>Stine Kongsted</b>	
50m		Frederikssund Skytteforening, I	MÅ1
09.08.2025		EM 2025	Hanebjerg Skyttecenter
Kommentar		Signatur	

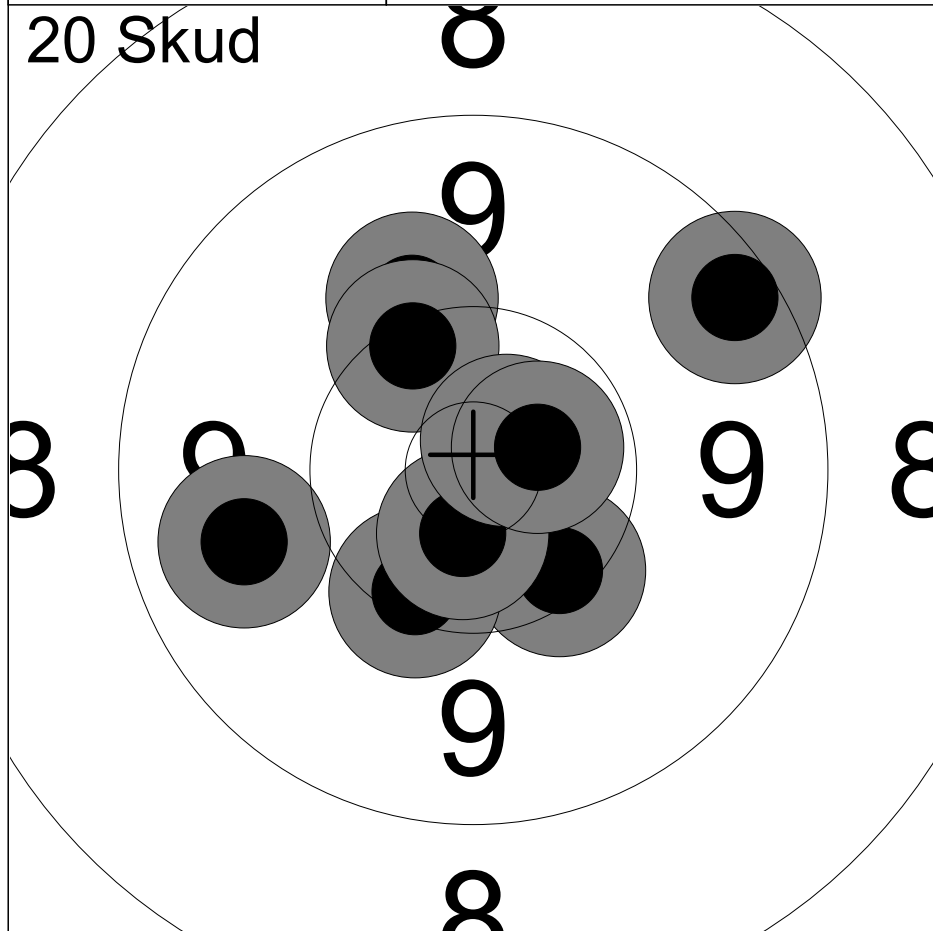

1:	10.1	↖
2:	10.3	↖
3:	9.4	↗
4:	10.3	↘
5:	10.8x	→
6:	10.3	↙
7:	10.6x	↘
8:	9.8	←
9:	10.7x	↗
10:	10.6x	→
Serie		98 ( 4x)
Total		98 ( 4x)

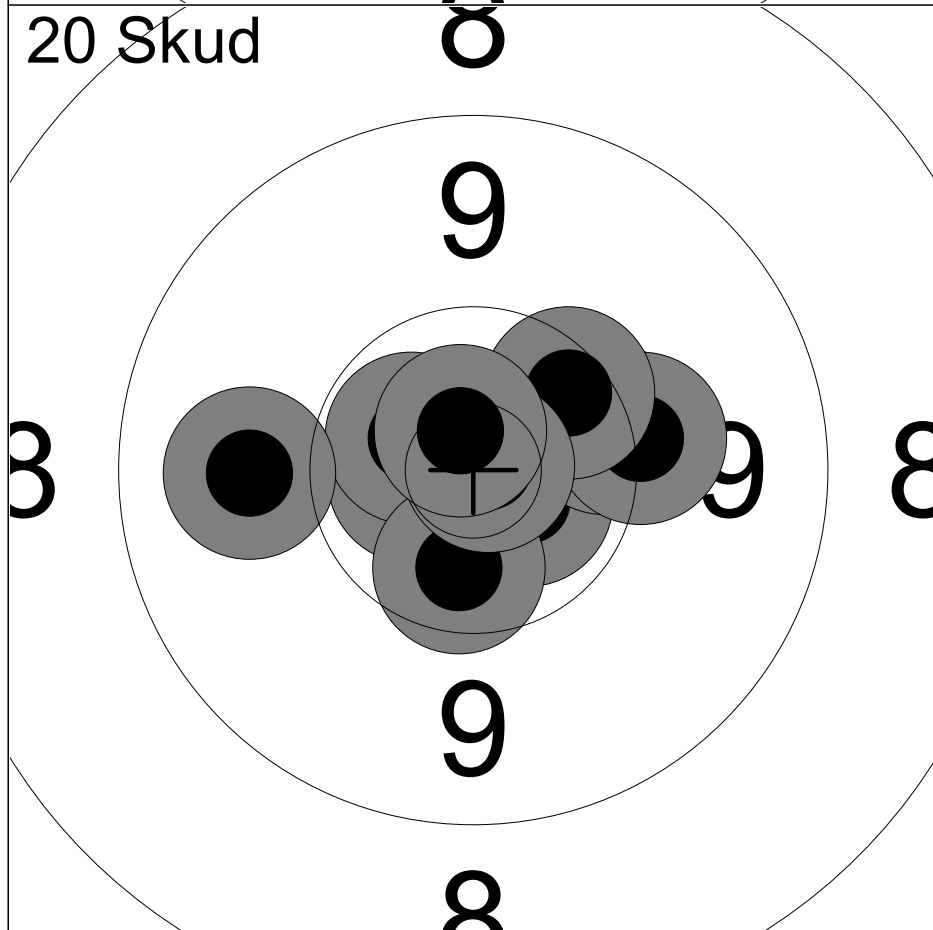

11:	10.7x	↘
12:	10.3	→
13:	10.1	→
14:	10.4	↗
15:	10.7x	←
16:	10.6x	↖
17:	10.5x	↘
18:	10.9x	→
19:	9.9	←
20:	10.7x	↖
Serie		99 ( 6x)
Total		197 (10x)

Hold <b>18</b>	Skive <b>12</b>	<b>Rasmus Andersen</b>	
50m		Frederikssund Skytteforening, I	MST3
09.08.2025		EM 2025	Hanebjerg Skyttecenter
Kommentar		Signatur	

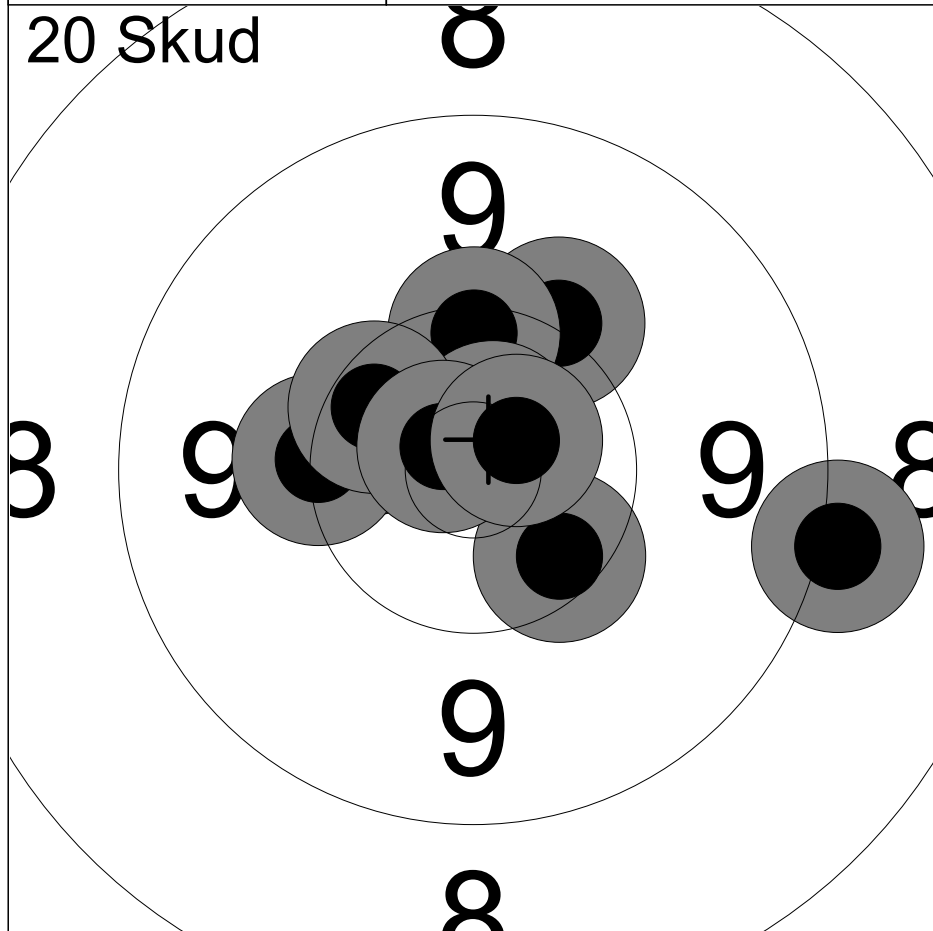

1:	10.1	↗
2:	10.4	↖
3:	10.2	←
4:	10.3	↑
5:	10.7x	↗
6:	10.4	↘
7:	9.1	→
8:	10.4	↗
9:	10.8x	↗
10:	10.7x	↗
Serie		99 ( 3x)
Total		99 ( 3x)

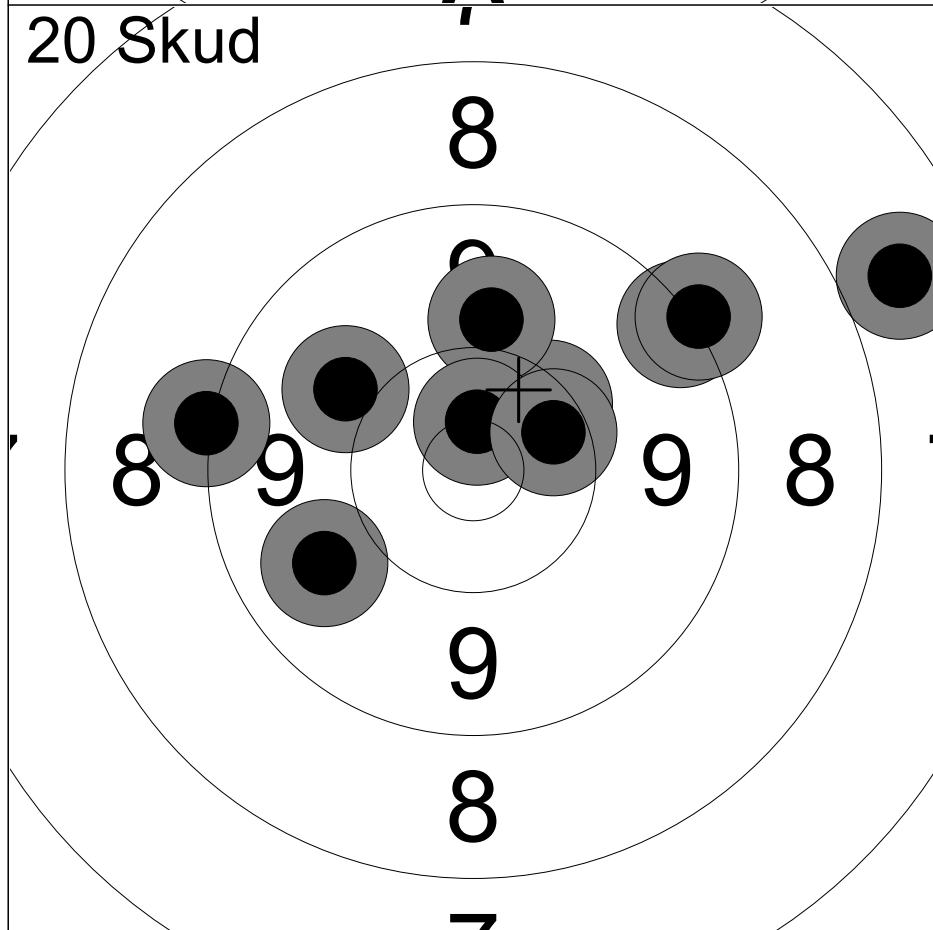

11:	9.8	↖
12:	9.1	↖
13:	10.3	↗
14:	7.8	→
15:	10.0	↑
16:	10.0	↖
17:	10.6x	↑
18:	9.3	↗
19:	9.1	↗
20:	10.4	↗
Serie		93 ( 1x)
Total		192 ( 4x)

Hold <b>19</b>	Skive <b>1</b>	<b>Agnete Soerensen</b>	
50m		Frederikssund Skytteforening, I	MÅ1
09.08.2025		EM 2025	Hanebjerg Skyttecenter
Kommentar		Signatur	

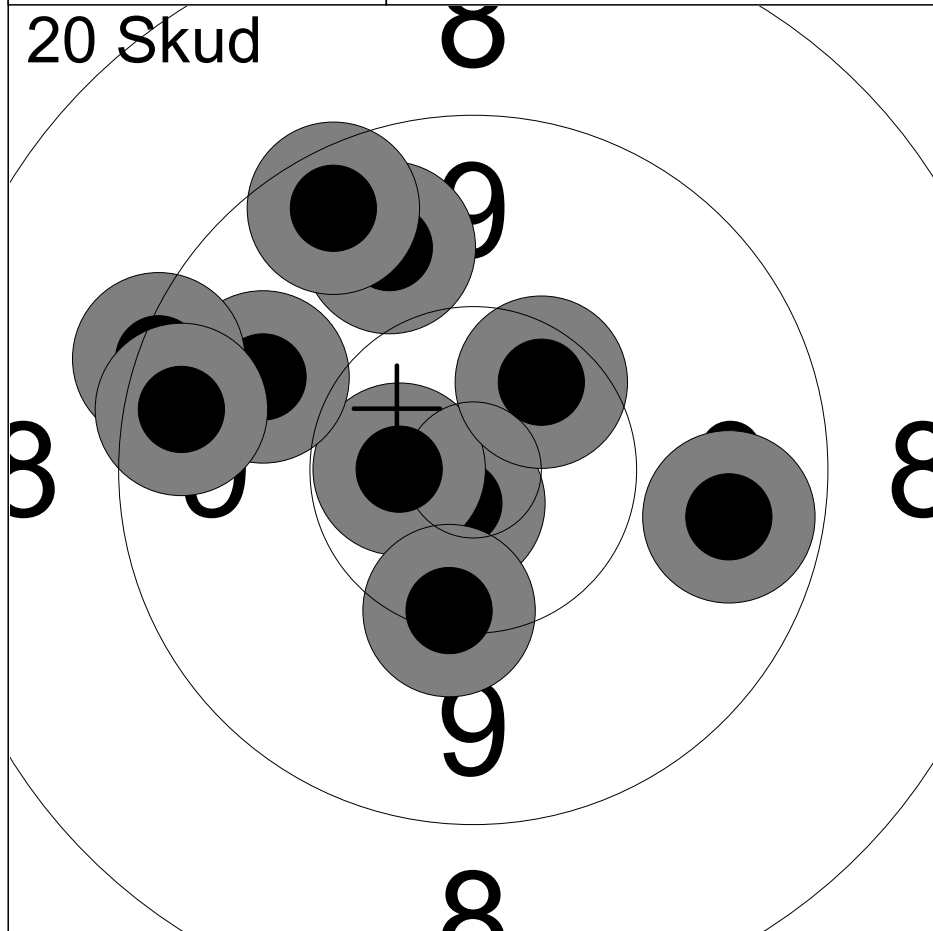

1:	10.8x	↘
2:	10.6x	←
3:	9.8	↗
4:	9.3	↗
5:	9.8	↗
6:	9.5	←
7:	10.4	↗
8:	9.5	↗
9:	10.3	↘
10:	9.7	→
Serie		94 ( 2x)
Total		94 ( 2x)

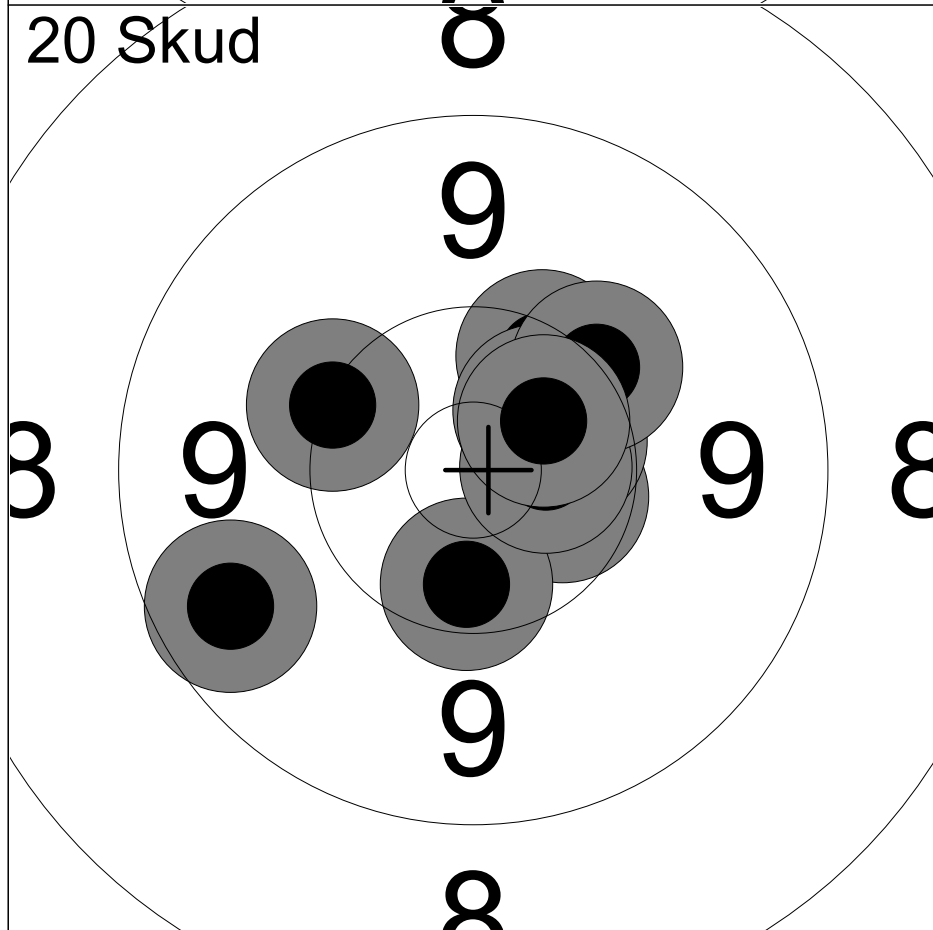

11:	10.5x	→
12:	10.4	↘
13:	10.3	↗
14:	10.5x	→
15:	10.6x	→
16:	10.5x	↗
17:	10.2	↗
18:	10.5x	↗
19:	9.6	←
20:	10.2	↖
Serie		99 ( 5x)
Total		193 ( 7x)

Hold <b>19</b>	Skive <b>2</b>	<b>Kasper Mygind</b>	
50m	Ganløse Skytteforening	MBK3	
09.08.2025	EM 2025	Hanebjerg Skyttecenter	
Kommentar	Signatur		

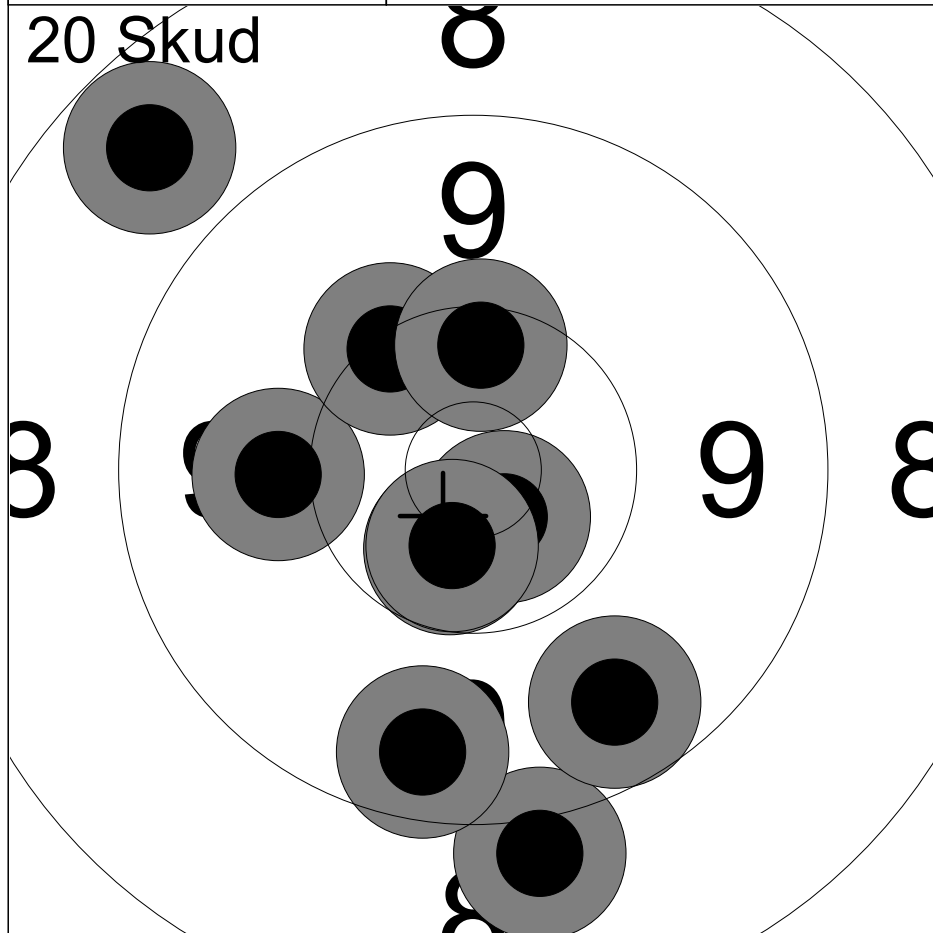

1:	10.6x	↘
2:	9.0	↘
3:	9.5	↘
4:	10.7x	↘
5:	10.0	←
6:	10.6x	↘
7:	10.2	↗
8:	9.6	↘
9:	10.3	↗
10:	8.6	↗

Serie	95 ( 3x)
Total	95 ( 3x)

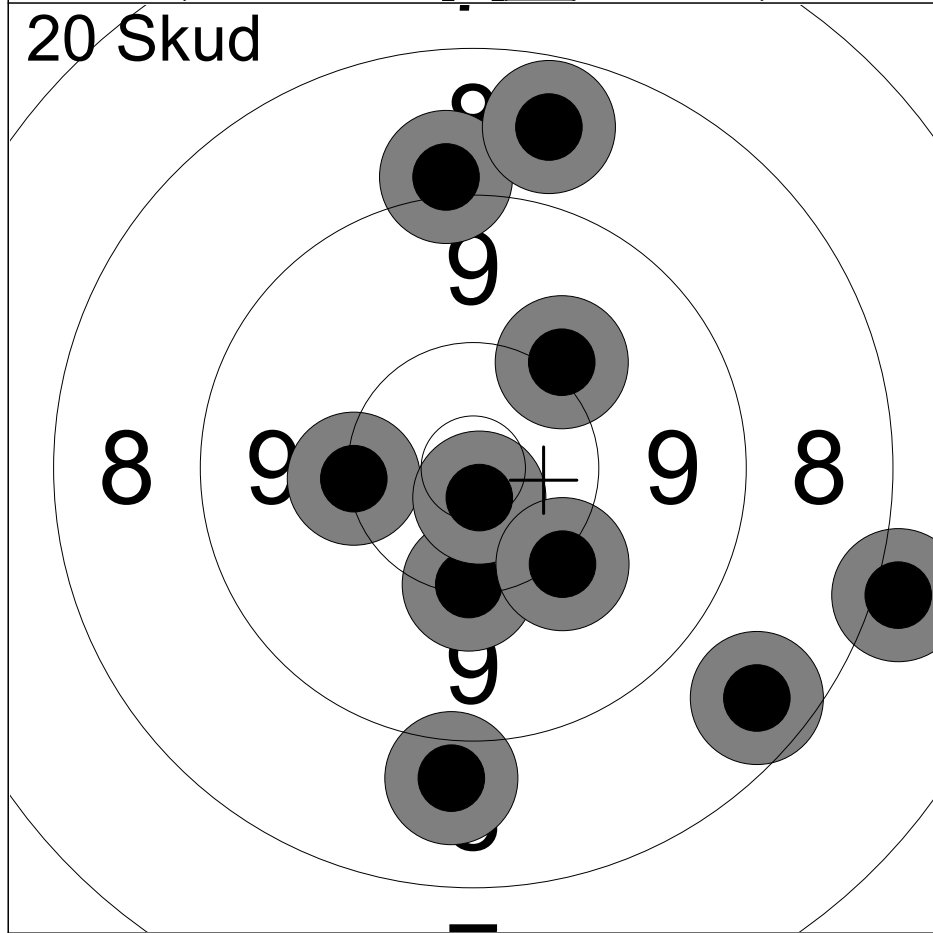

11:	10.1	↗
12:	10.2	←
13:	8.5	↘
14:	10.2	↘
15:	10.8x	↘
16:	9.0	↗
17:	8.7	↗
18:	8.9	↘
19:	10.1	↘
20:	8.0	↘

Serie	91 ( 1x)
Total	186 ( 4x)

Hold <b>19</b>	Skive <b>3</b>	<b>Emmily Brendstrup</b>	
50m	Ganløse Skytteforening	MBK3	
09.08.2025	EM 2025	Hanebjerg Skyttecenter	
Kommentar	Signatur		

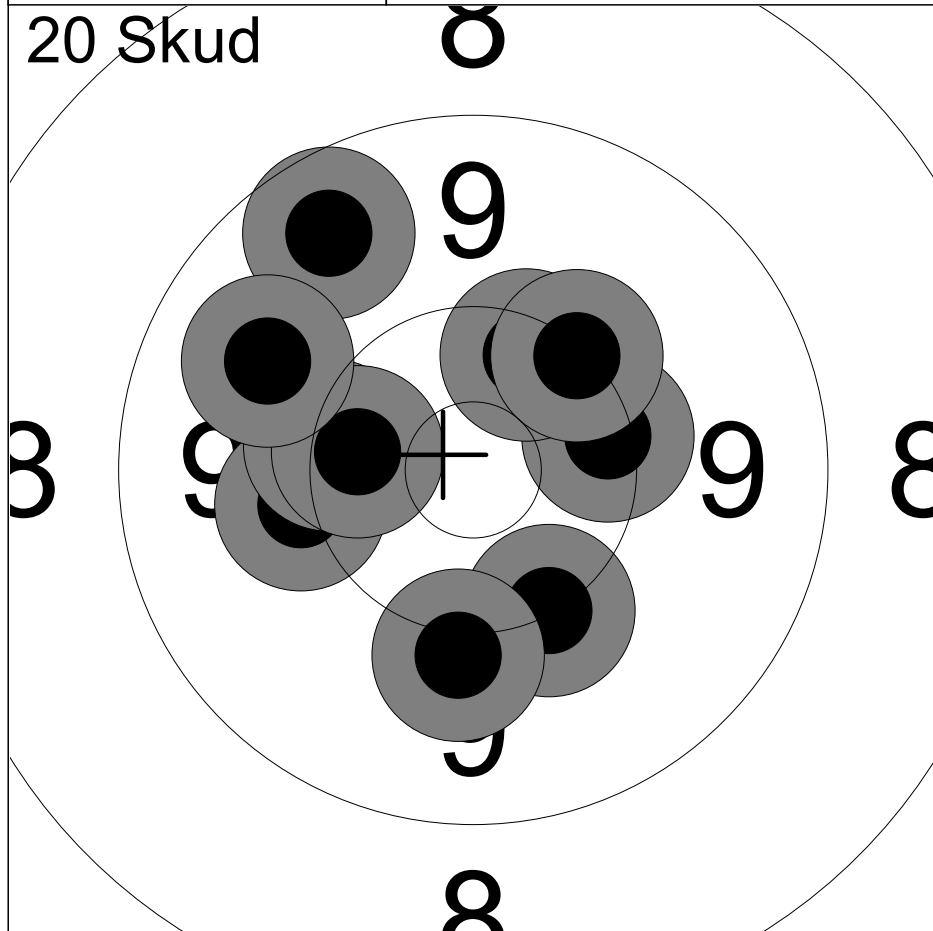

1:	10.1	←
2:	9.6	↗
3:	10.2	←
4:	10.4	←
5:	10.3	↗
6:	10.2	↘
7:	10.3	↗
8:	10.0	↘
9:	9.8	↖
10:	10.2	↗
Serie		98 ( 0x)
Total		98 ( 0x)

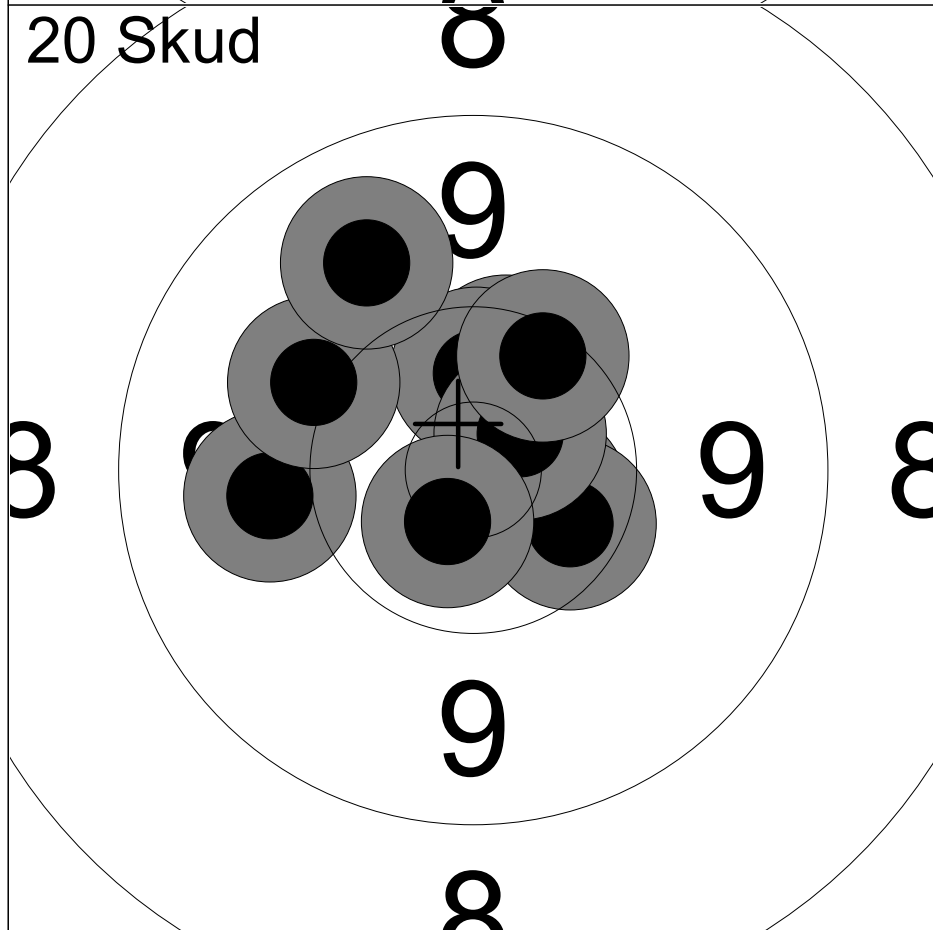

11:	10.6x	→
12:	10.4	↗
13:	10.0	←
14:	10.4x	↘
15:	10.5x	↑
16:	10.7x	↗
17:	10.7x	↘
18:	10.3	↗
19:	10.1	↖
20:	9.8	↖
Serie		99 ( 5x)
Total		197 ( 5x)

Hold <b>19</b>	Skive <b>5</b>	<b>Benjamin Landman</b>	
50m	Kreds 57, Ferslev, Skibby	MJ2	
09.08.2025	EM 2025	Hanebjerg Skyttecenter	
Kommentar	Signatur		

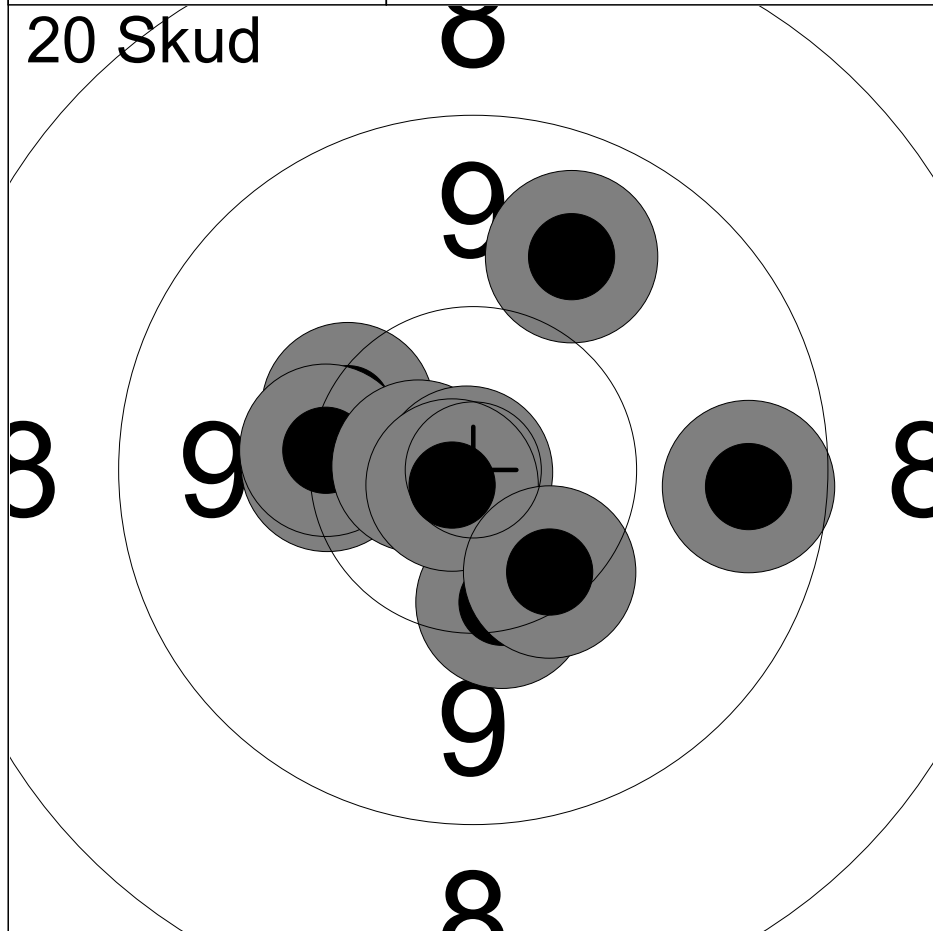

1:	9.6	→
2:	10.3	↖
3:	10.2	←
4:	10.3	↓
5:	9.8	↗
6:	10.2	←
7:	10.7x	←
8:	10.9x	←
9:	10.8x	↖
10:	10.3	↘
Serie		98 ( 3x)
Total		98 ( 3x)

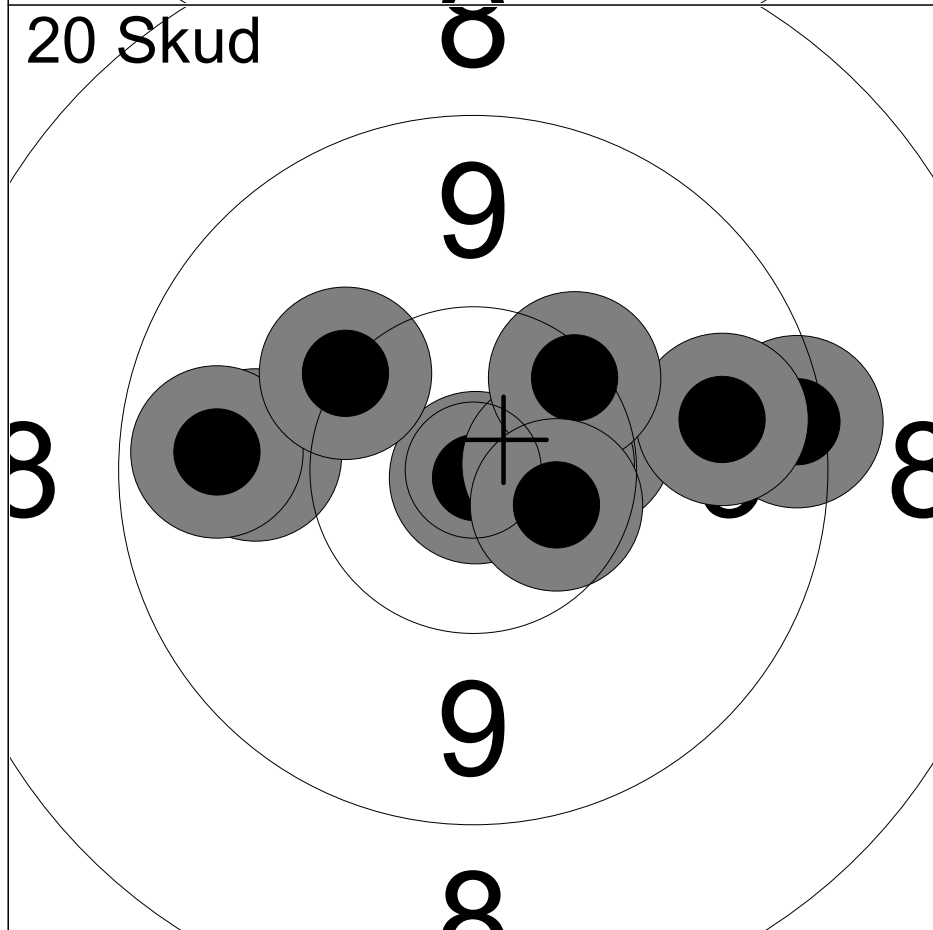

11:	10.9x	↓
12:	10.4	→
13:	9.9	←
14:	9.3	→
15:	9.7	←
16:	10.2	↗
17:	9.7	→
18:	10.6x	→
19:	10.3	↗
20:	10.5x	↘
Serie		96 ( 3x)
Total		194 ( 6x)

Hold <b>19</b>	Skive <b>6</b>	<b>Villads Jespersen</b>	
50m	Kreds 57, Ferslev, Skibby	BK3	
09.08.2025	EM 2025	Hanebjerg Skyttecenter	
Kommentar	Signatur		

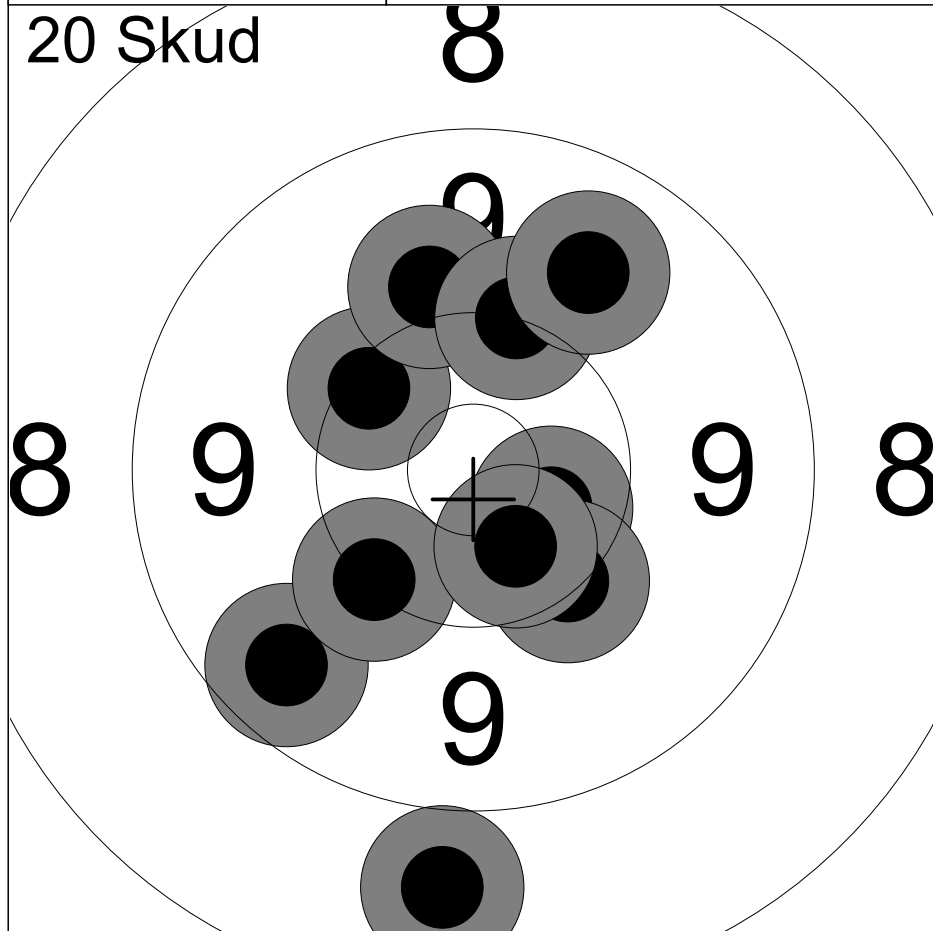

1:	10.5x	↘
2:	10.3	↖
3:	10.0	↑
4:	9.6	↙
5:	10.2	↑
6:	10.2	↘
7:	10.2	↙
8:	10.5x	↘
9:	8.8	↓
10:	9.8	↗
Serie		96 ( 2x)
Total		96 ( 2x)

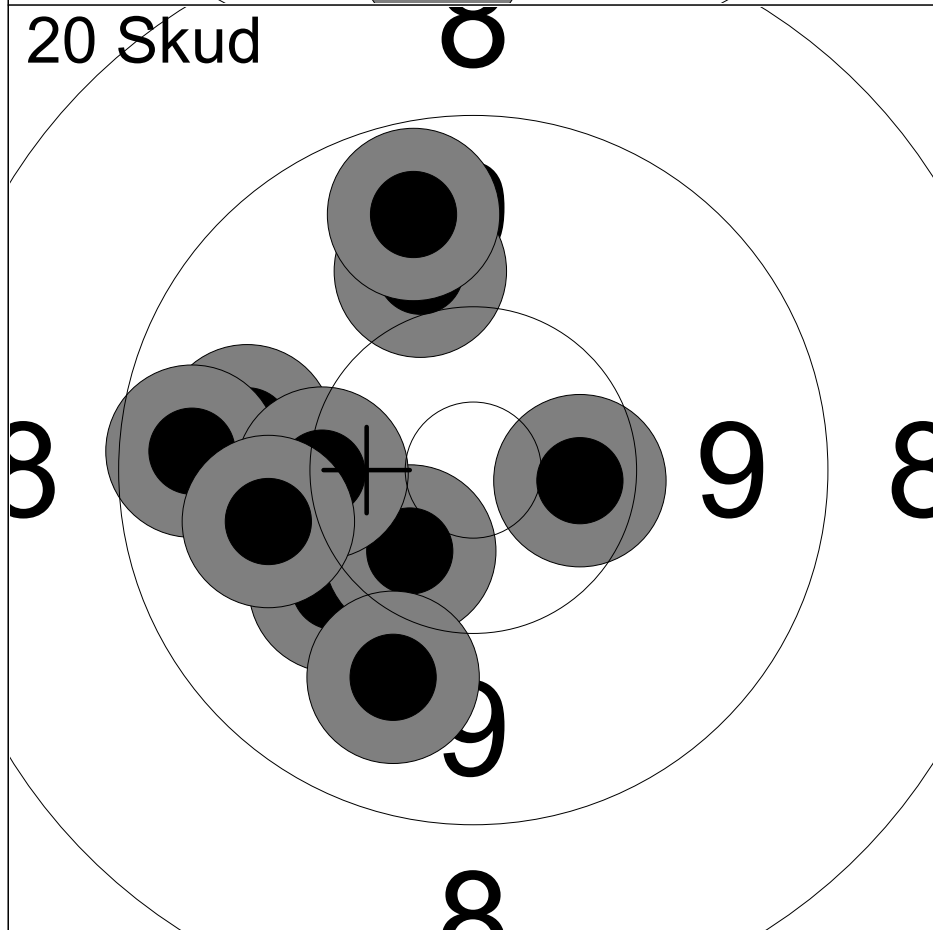

11:	9.8	←
12:	10.0	↑
13:	10.1	↙
14:	10.4x	↙
15:	9.6	←
16:	10.2	←
17:	9.7	↑
18:	10.4x	→
19:	9.9	←
20:	9.9	↘
Serie		95 ( 2x)
Total		191 ( 4x)

Hold <b>19</b>	Skive <b>8</b>	<b>Sara Aaslev Noerager Bay</b>		
50m		Ølstykke Skytteforening		MST2
09.08.2025		EM 2025		Hanebjerg Skyttecenter
Kommentar		Signatur		

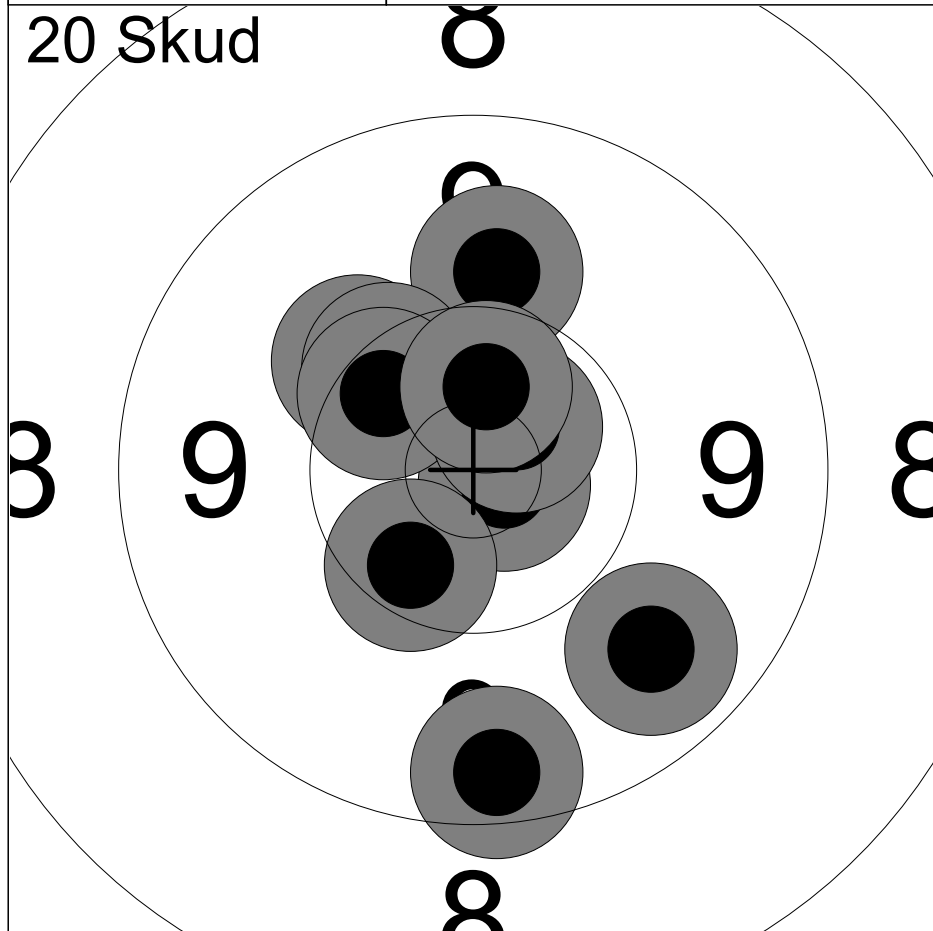

1:	10.0	↑
2:	10.2	↗
3:	10.8x	↘
4:	10.4	↙
5:	9.4	↓
6:	9.7	↘
7:	10.3	↗
8:	10.4	↗
9:	10.7x	↗
10:	10.5x	↑
Serie		98 ( 3x)
Total		98 ( 3x)

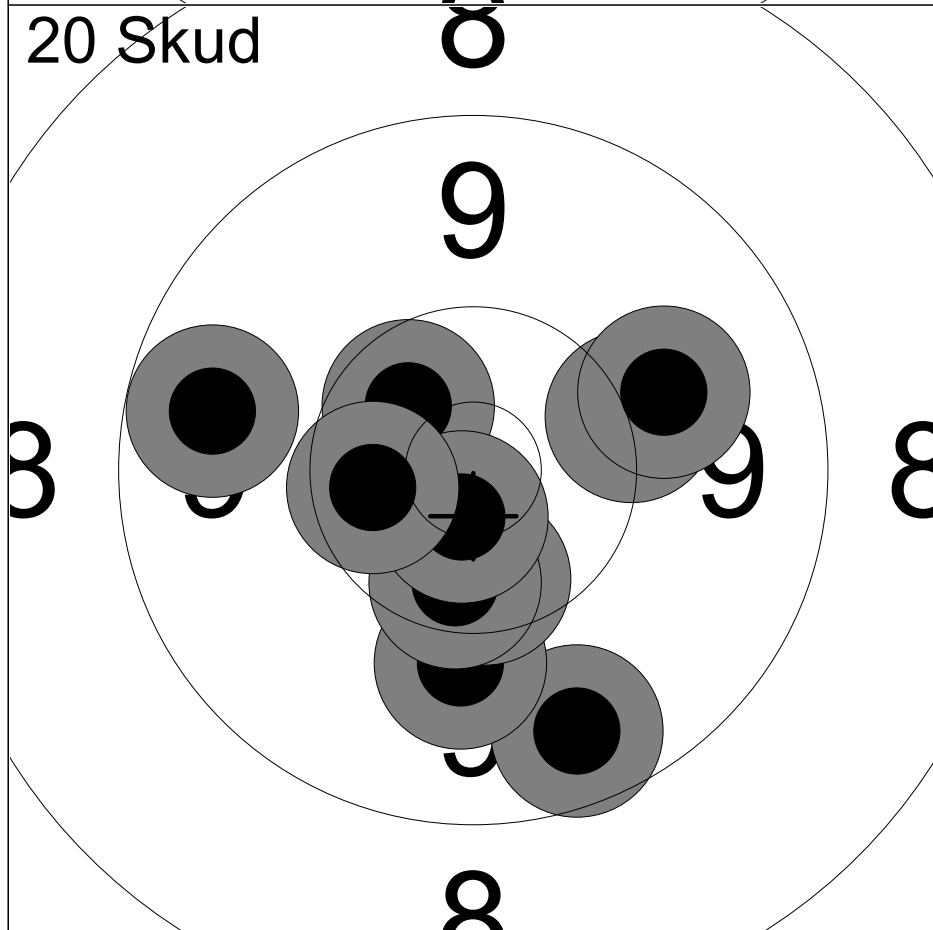

11:	9.6	↓
12:	10.1	↗
13:	10.0	↓
14:	10.5x	↗
15:	10.4x	↓
16:	9.6	↖
17:	10.4	↓
18:	10.7x	↓
19:	9.9	↗
20:	10.5x	↖
Serie		97 ( 4x)
Total		195 ( 7x)

Hold <b>19</b>	Skive <b>10</b>	<b>Kim Noerager Bay</b>		
50m		Egedal Skytteforening	MST2	
09.08.2025		EM 2025	Hanebjerg Skyttecenter	
Kommentar		Signatur		

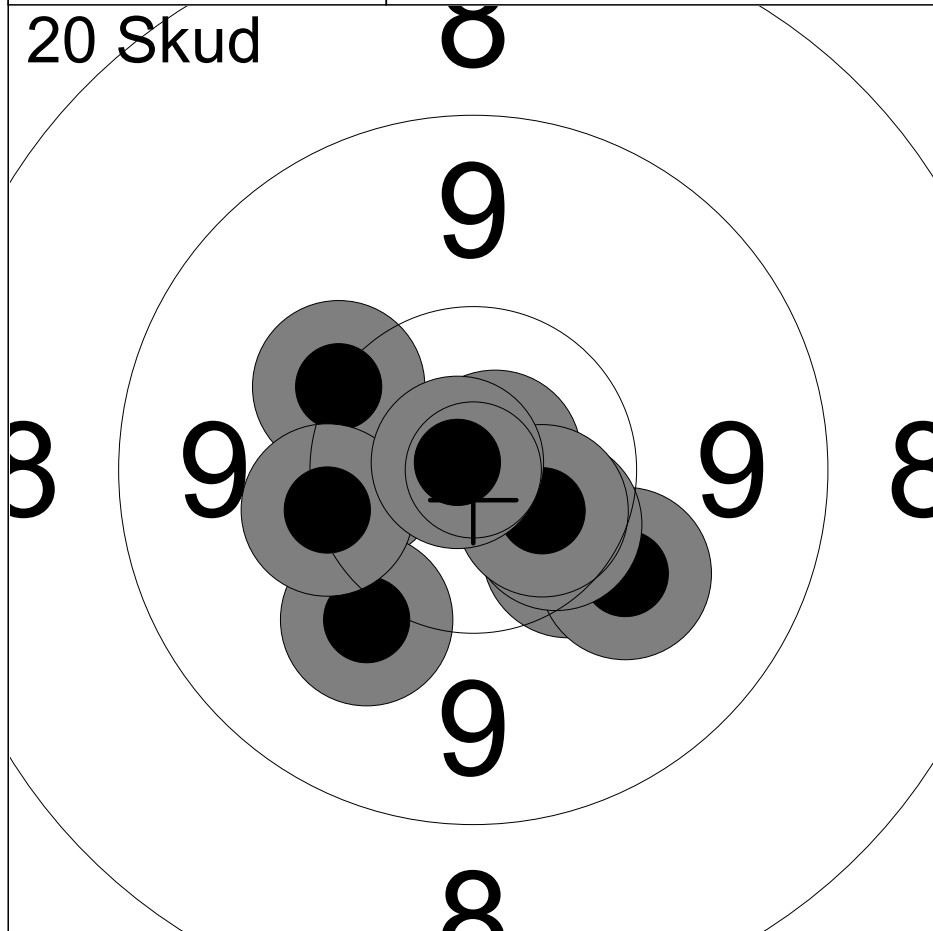

1:	10.3	↘
2:	10.8x	↗
3:	10.1	↘
4:	10.4	←
5:	10.2	↗
6:	10.1	↘
7:	10.2	←
8:	10.5x	↘
9:	10.6x	↘
10:	10.9x	↗
Serie		100 ( 4x)
Total		100 ( 4x)

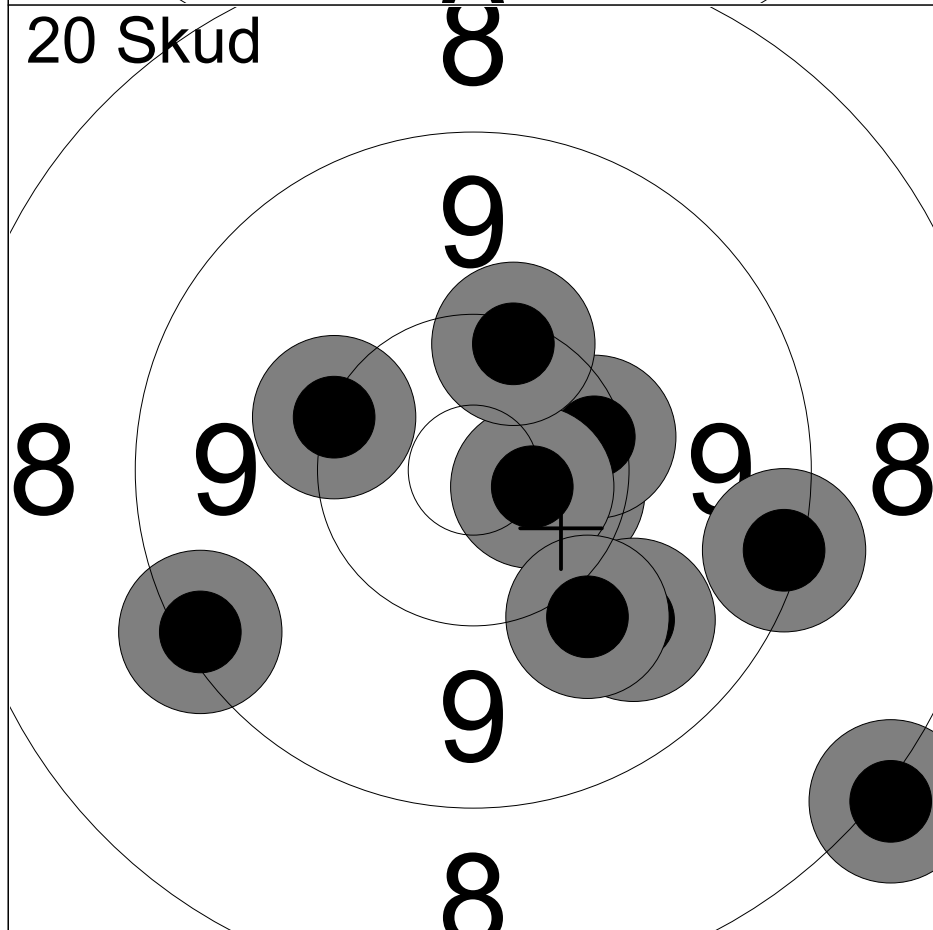

11:	9.3	←
12:	10.2	↗
13:	8.1	↘
14:	10.5x	→
15:	10.3	↗
16:	10.6x	→
17:	9.3	→
18:	9.8	↘
19:	10.0	↘
20:	10.3	↗
Serie		95 ( 2x)
Total		195 ( 6x)

Hold <b>19</b>	Skive <b>11</b>	<b>Palle Kofoed</b>	
50m		Østerlars Skytteforening	MÅ1
09.08.2025		EM 2025	Hanebjerg Skyttecenter
Kommentar		Signatur	



1:	10.3	↑
2:	9.9	↘
3:	10.4	↑
4:	10.4x	→
5:	10.7x	←
6:	10.7x	↘
7:	10.6x	→
8:	10.5x	↗
9:	10.7x	↗
10:	10.6x	↓
Serie		99 ( 7x)
Total		99 ( 7x)

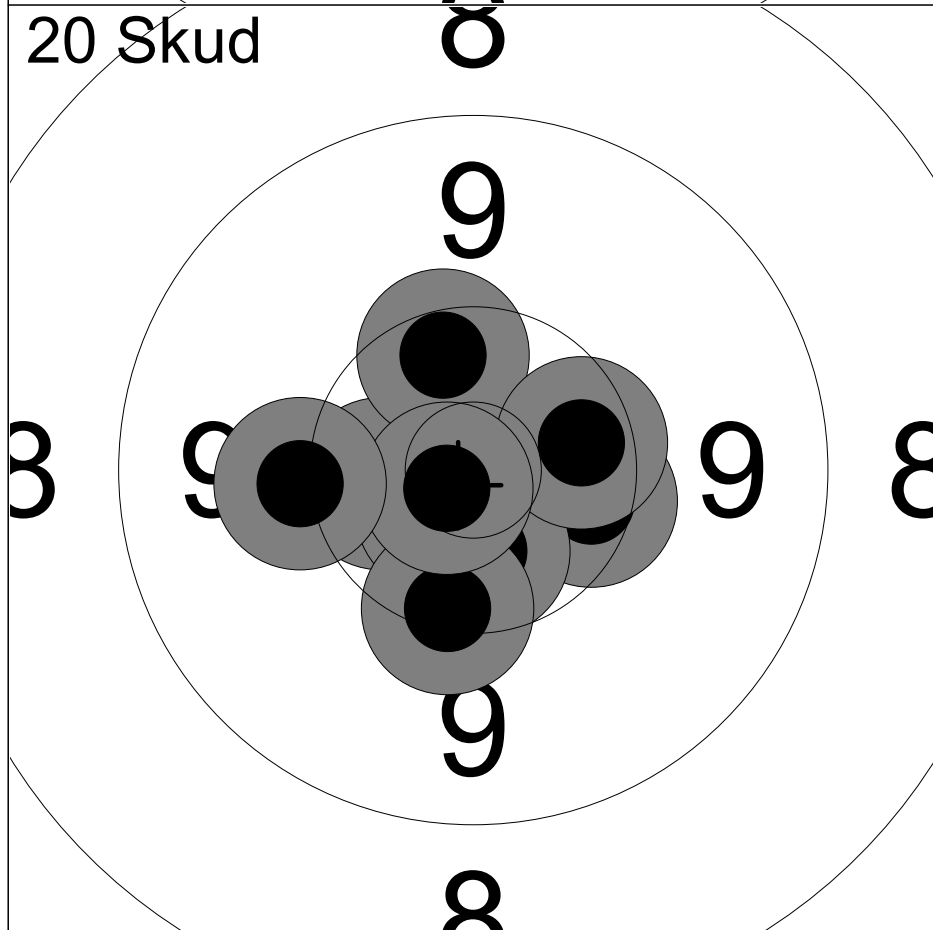

11:	10.4	→
12:	10.5x	←
13:	10.7x	↘
14:	10.4	↑
15:	10.7x	↘
16:	10.6x	↓
17:	10.3	↓
18:	10.4	→
19:	10.8x	←
20:	10.1	←
Serie		100 ( 5x)
Total		199 (12x)

Hold <b>19</b>	Skive <b>12</b>	<b>Ida Aaslev Noerager Bay</b>	
50m		Ølstykke Skytteforening	MST2
09.08.2025		EM 2025	Hanebjerg Skyttecenter
Kommentar		Signatur	

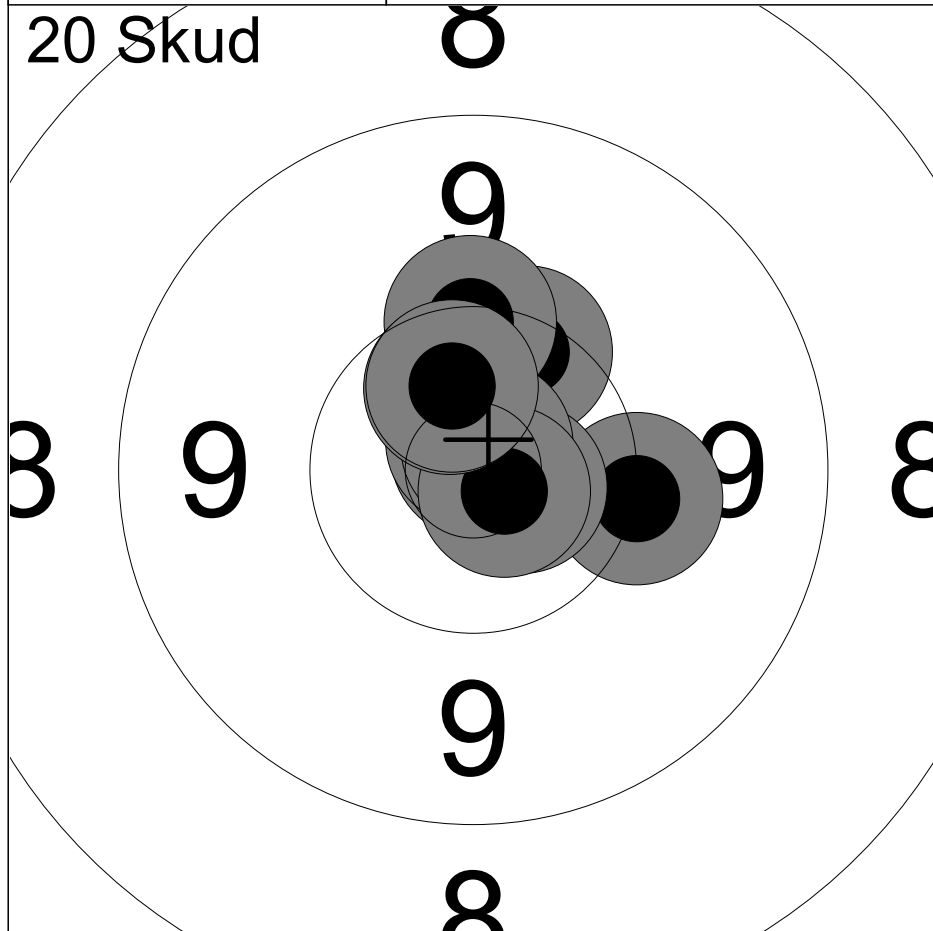

1:	10.3	↗
2:	10.1	→
3:	10.9x	↗
4:	10.2	↗
5:	10.8x	↗
6:	10.7x	→
7:	10.8x	↗
8:	10.8x	↘
9:	10.5x	↗
10:	10.5x	↗
Serie		100 ( 7x)
Total		100 ( 7x)

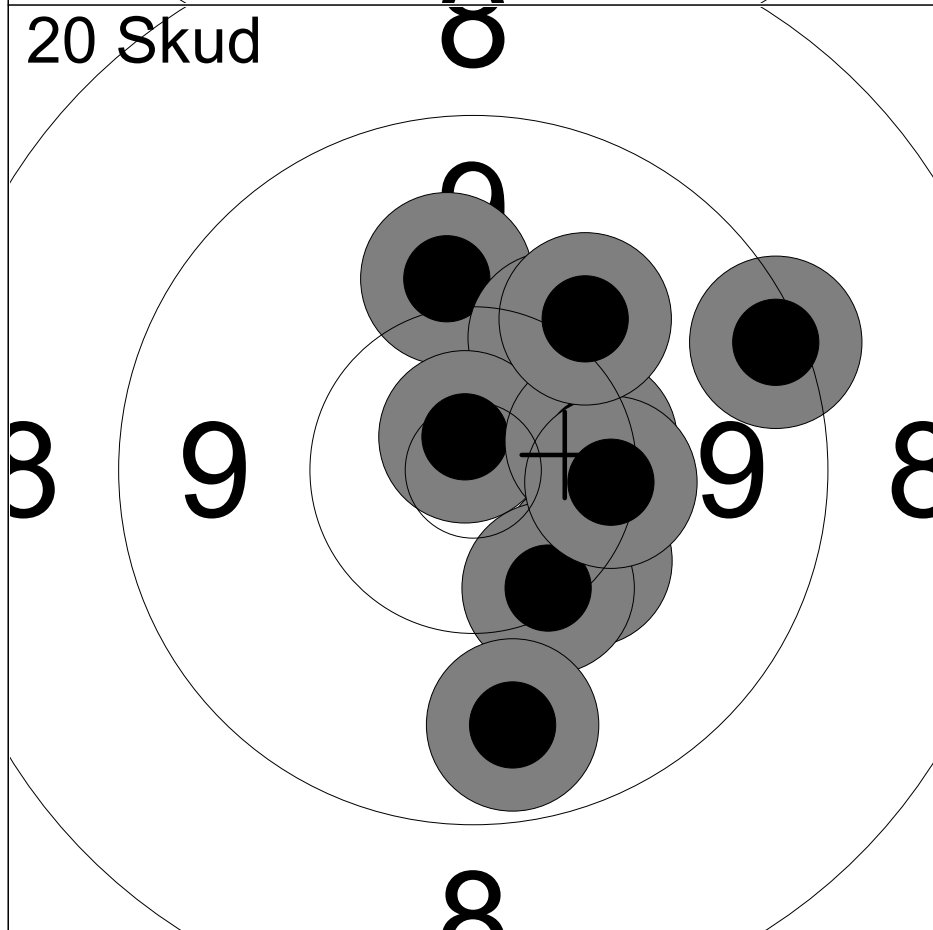

11:	10.0	↗
12:	10.2	↗
13:	10.2	↘
14:	10.3	↘
15:	9.7	↘
16:	10.8x	↗
17:	10.4	→
18:	9.3	→
19:	10.3	→
20:	10.0	↗
Serie		98 ( 1x)
Total		198 ( 8x)

Hold <b>20</b>	Skive <b>1</b>	<b>Freya Kofoed</b>		
50m	Østerlars Skytteforening		MST2	
09.08.2025	EM 2025	Hanebjerg Skyttecenter		
Kommentar	Signatur			

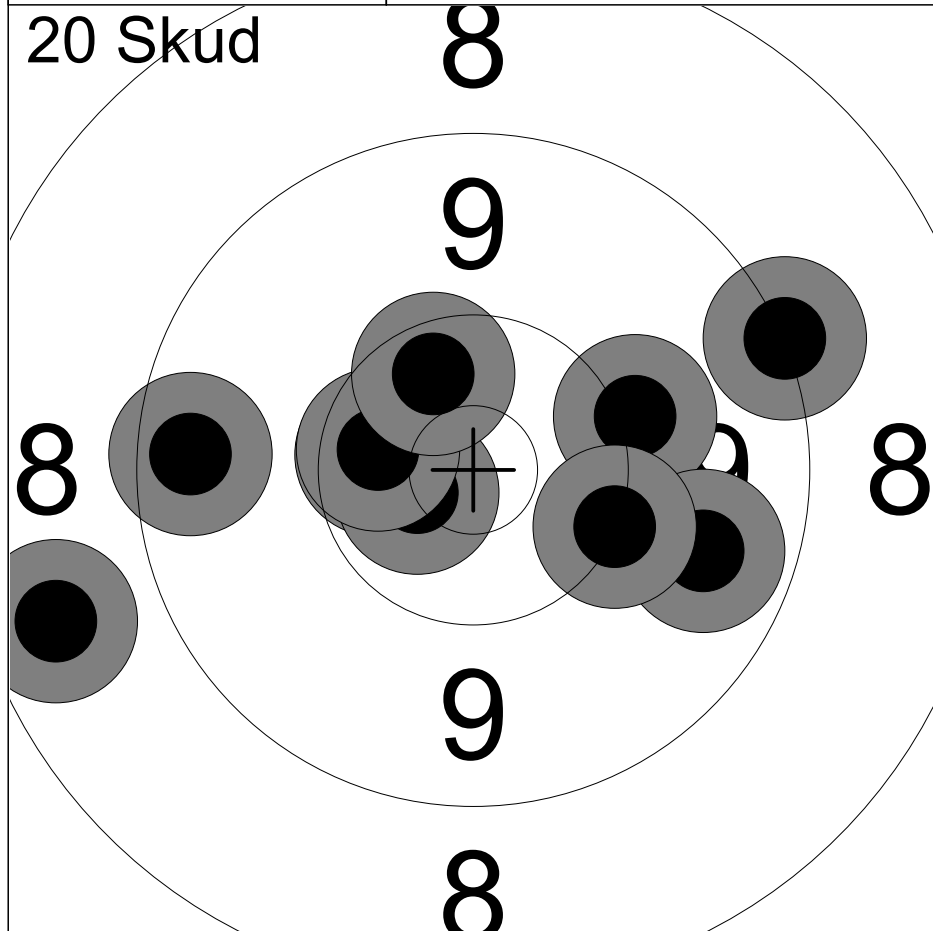

1:	9.5	←
2:	10.4x	←
3:	10.6x	←
4:	8.6	←
5:	10.5x	←
6:	9.2	→
7:	10.1	→
8:	9.7	→
9:	10.2	→
10:	10.4x	↖
Serie		95 ( 4x)
Total		95 ( 4x)

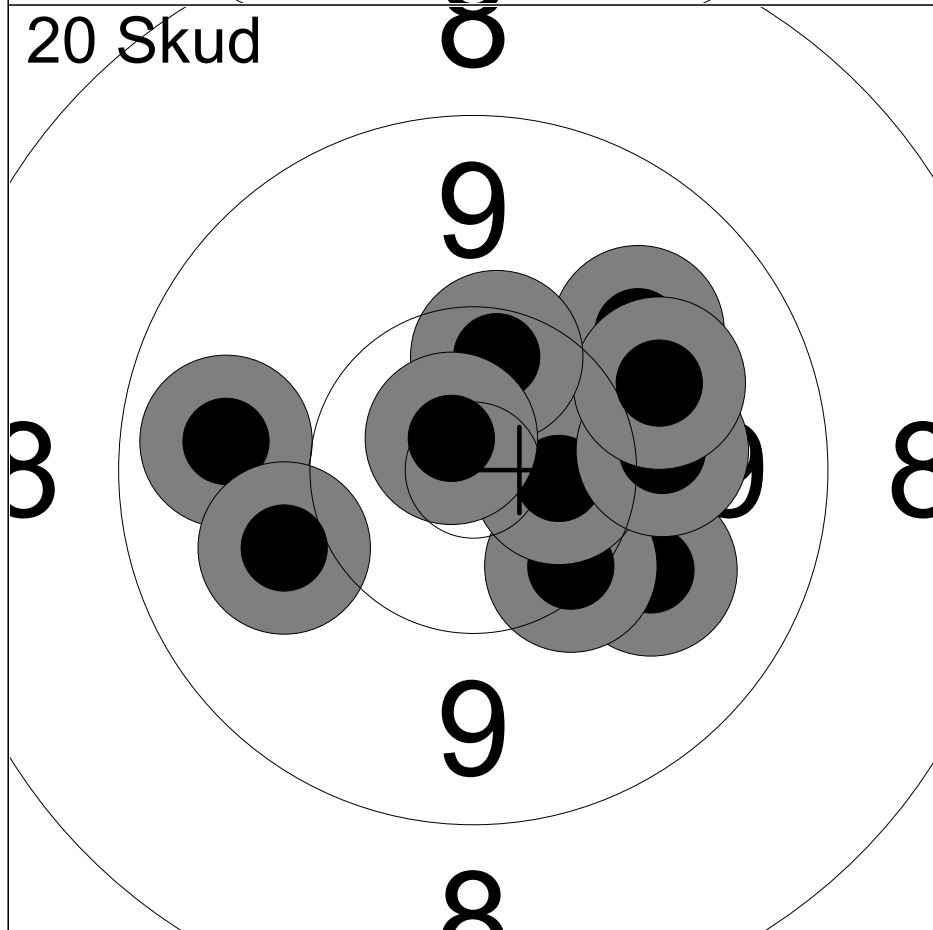

11:	10.0	↘
12:	10.3	↘
13:	10.5x	→
14:	9.9	↗
15:	10.0	→
16:	9.7	←
17:	10.0	←
18:	10.0	↗
19:	10.4	↖
20:	10.8x	↖
Serie		98 ( 2x)
Total		193 ( 6x)

Hold <b>20</b>	Skive <b>2</b>	<b>Amanda Jensen</b>	
50m	Kreds 57, Ferslev, Skibby	J1	
09.08.2025	EM 2025	Hanebjerg Skyttecenter	
Kommentar	Signatur		

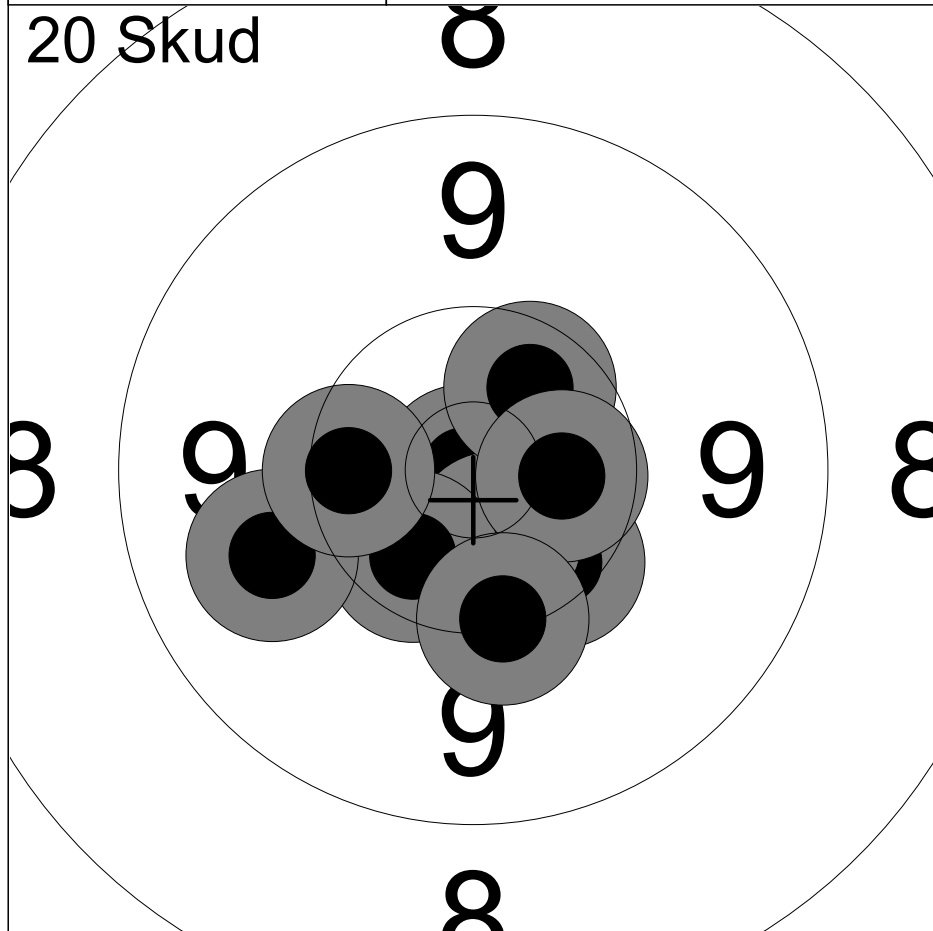

1:	10.6x	→
2:	10.3	↘
3:	10.9x	←
4:	10.6x	↘
5:	10.5x	↗
6:	10.4x	↘
7:	9.9	←
8:	10.5x	→
9:	10.3	←
10:	10.2	↘
Serie		99 ( 6x)
Total		99 ( 6x)

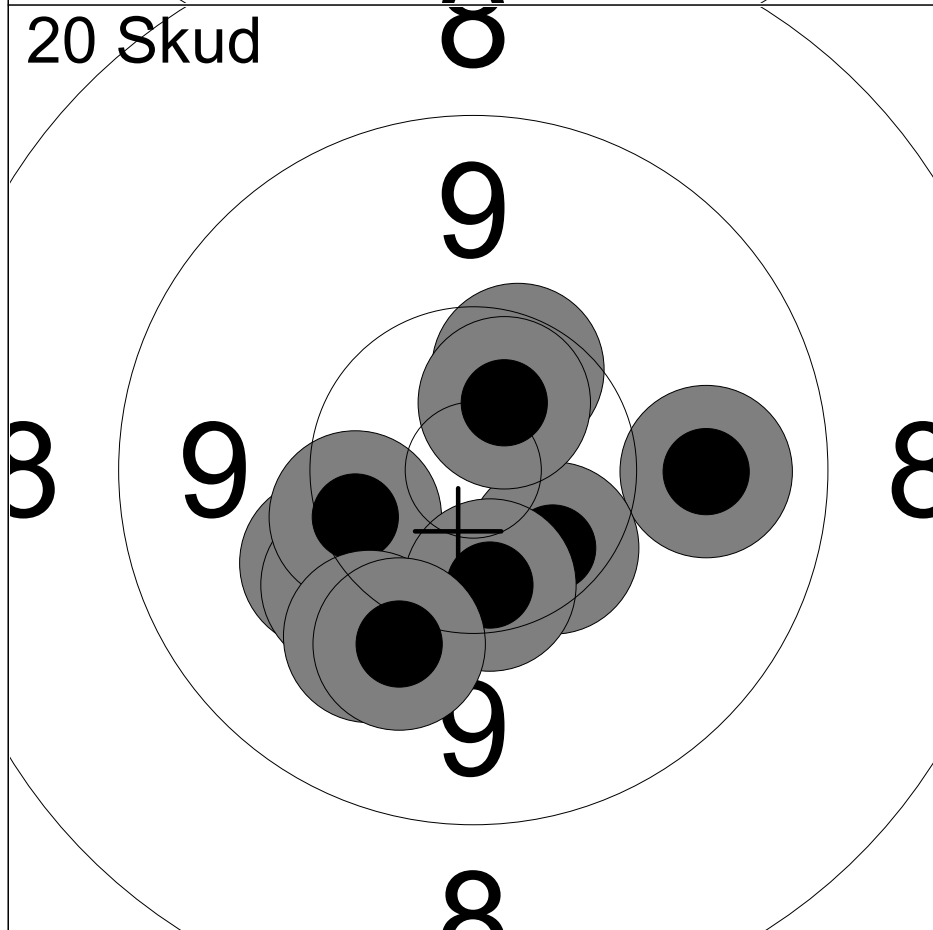

11:	10.4x	↗
12:	10.1	←
13:	9.8	→
14:	10.1	↘
15:	10.3	←
16:	10.4	↘
17:	10.4	↘
18:	10.6x	↗
19:	10.0	↘
20:	10.0	↘
Serie		99 ( 2x)
Total		198 ( 8x)

Hold <b>20</b>	Skive <b>3</b>	<b>Theodor Hejnfelt</b>	
50m	Kreds 57, Ferslev, Skibby		MBK2
09.08.2025	EM 2025	Hanebjerg Skyttecenter	
Kommentar	Signatur		

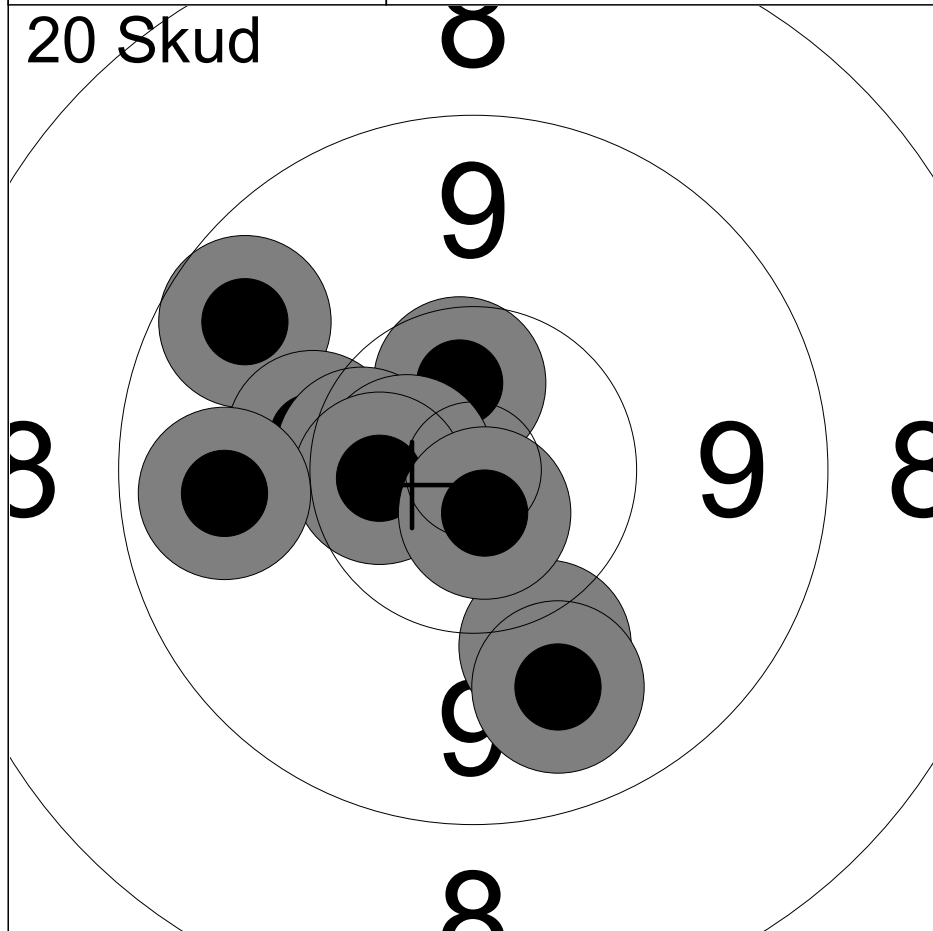

1:	10.5x	↑
2:	9.6	↗
3:	10.2	←
4:	10.0	↘
5:	10.4	←
6:	10.6x	←
7:	10.5x	←
8:	9.8	↘
9:	9.7	←
10:	10.7x	↘
Serie		97 ( 4x)
Total		97 ( 4x)

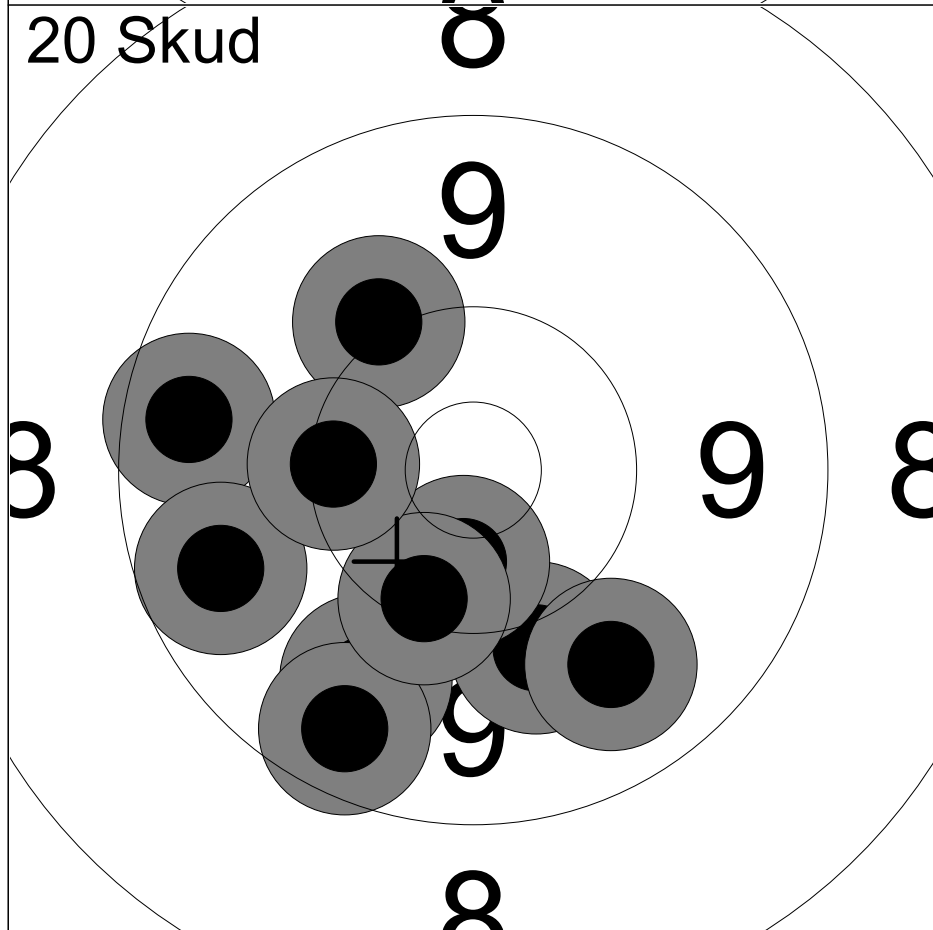

11:	9.8	↘
12:	10.0	↘
13:	9.8	↘
14:	10.5x	↘
15:	10.1	↗
16:	9.5	↘
17:	9.5	←
18:	10.3	↘
19:	9.6	←
20:	10.3	←
Serie		95 ( 1x)
Total		192 ( 5x)

Hold <b>20</b>	Skive <b>5</b>	<b>Mette Ea Schou-Friis</b>	
50m		Dauglykke Skytteforening	ST3
09.08.2025		EM 2025	Hanebjerg Skyttecenter
Kommentar		Signatur	

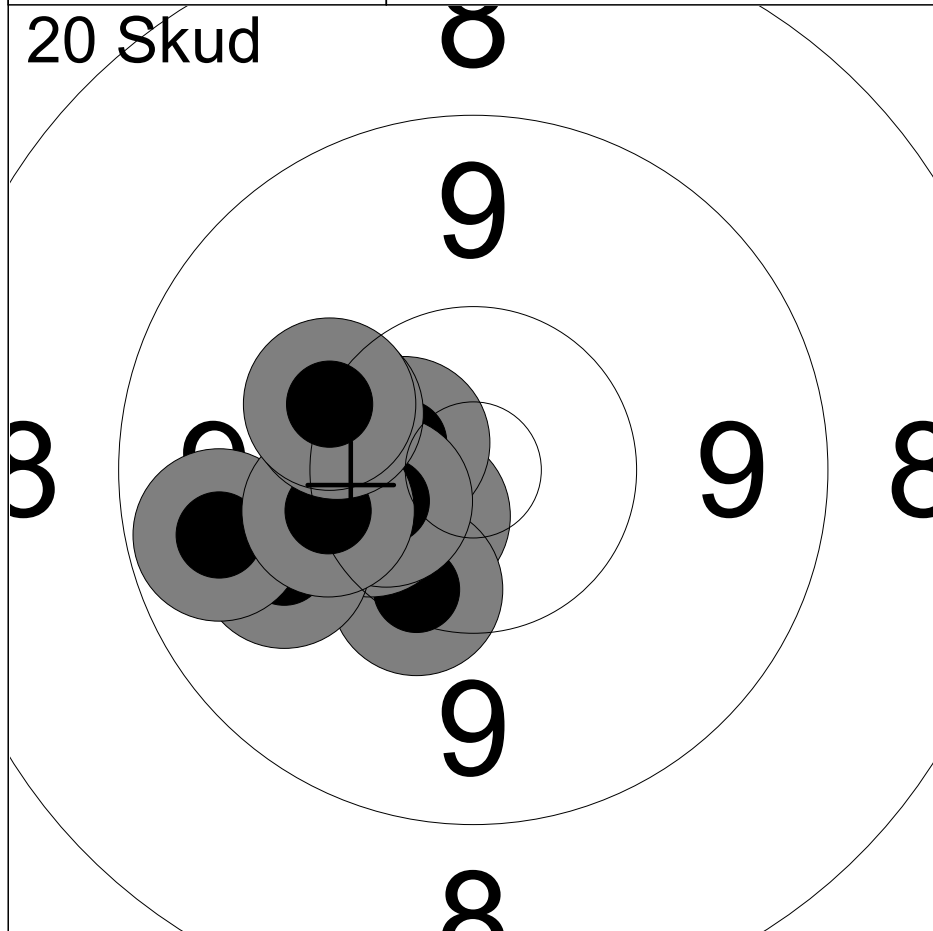

1:	10.6x	↙
2:	10.3	↘
3:	10.4	↙
4:	10.6x	↙
5:	9.9	↙
6:	9.7	↙
7:	10.5x	↙
8:	10.2	↙
9:	10.2	↙
10:	10.2	↙
Serie		98 ( 3x)
Total		98 ( 3x)

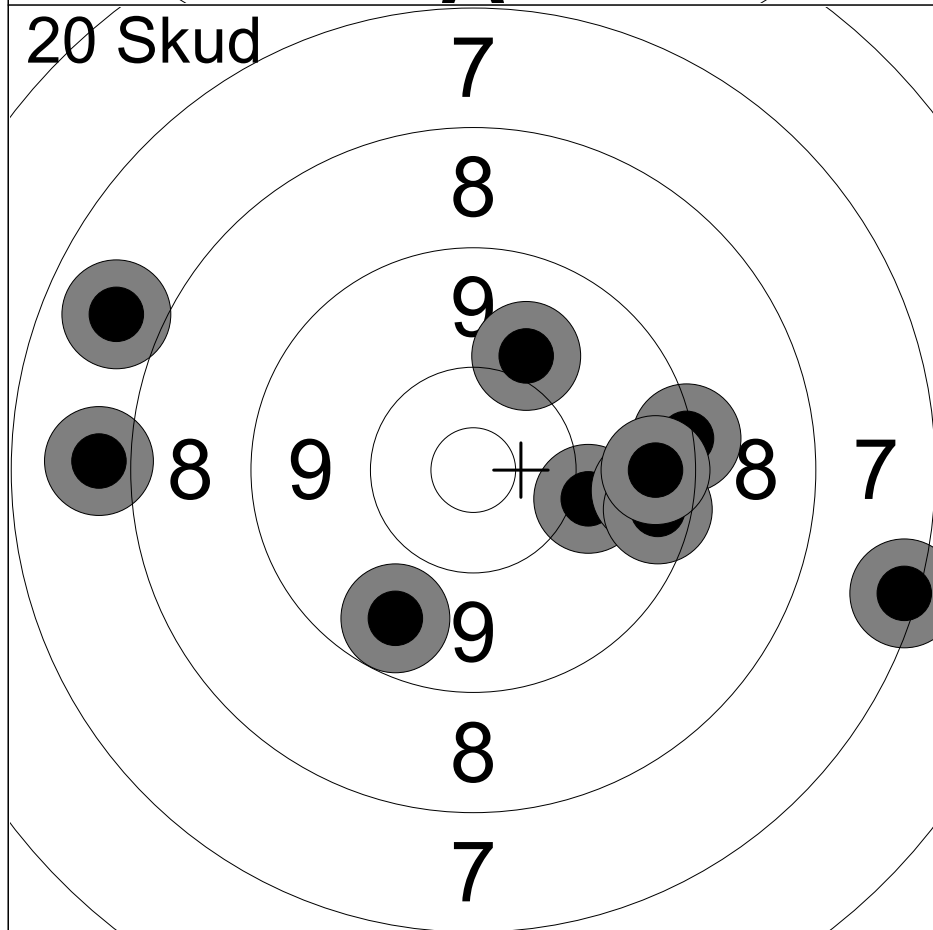

11:	10.0	→
12:	9.6	→
13:	9.2	→
14:	9.6	↘
15:	9.5	→
16:	7.3	→
17:	7.8	↙
18:	7.9	↙
19:	9.5	→
20:	10.0	↗
Serie		86 ( 0x)
Total		184 ( 3x)

Hold <b>20</b>	Skive <b>6</b>	<b>Martin Schou-Friis</b>	
50m	Dauglykke Skytteforening	ST3	
09.08.2025	EM 2025	Hanebjerg Skyttecenter	
Kommentar	Signatur		

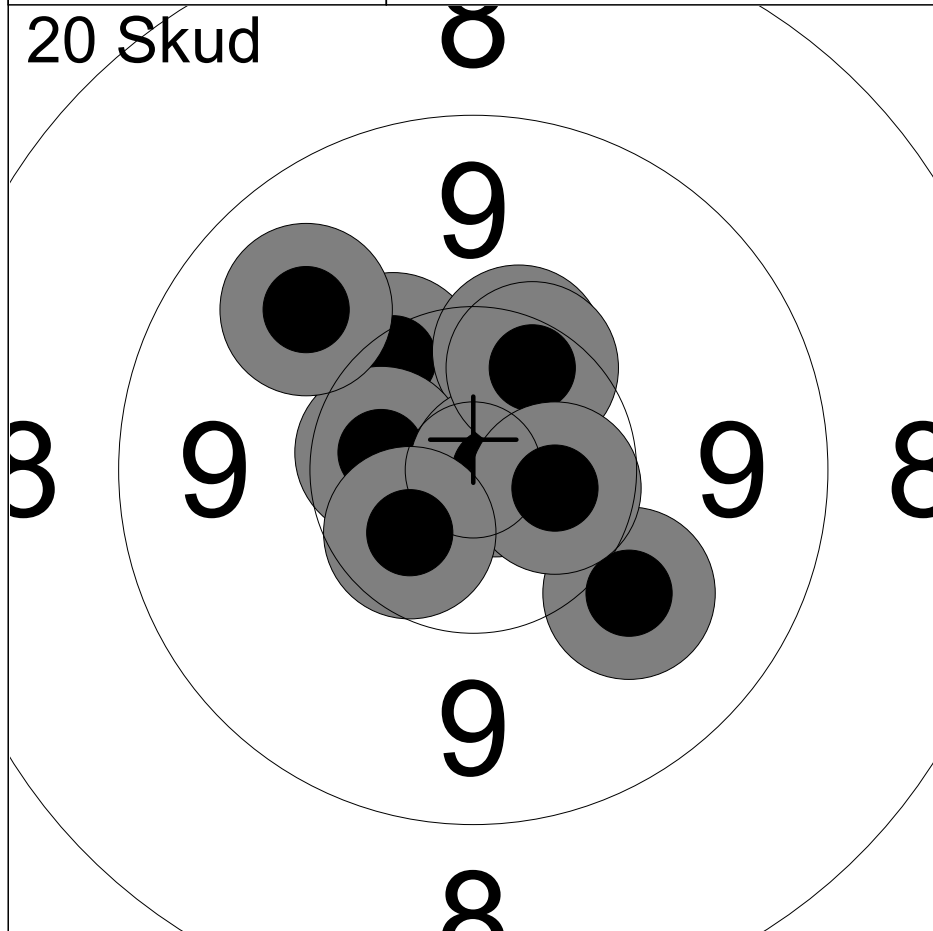

1:	10.5x	↗
2:	10.3	↘
3:	10.3	↗
4:	10.5x	↖
5:	9.8	↗
6:	10.8x	→
7:	10.4	↗
8:	10.0	↘
9:	10.5x	→
10:	10.5x	↙
Serie		99 ( 5x)
Total		99 ( 5x)

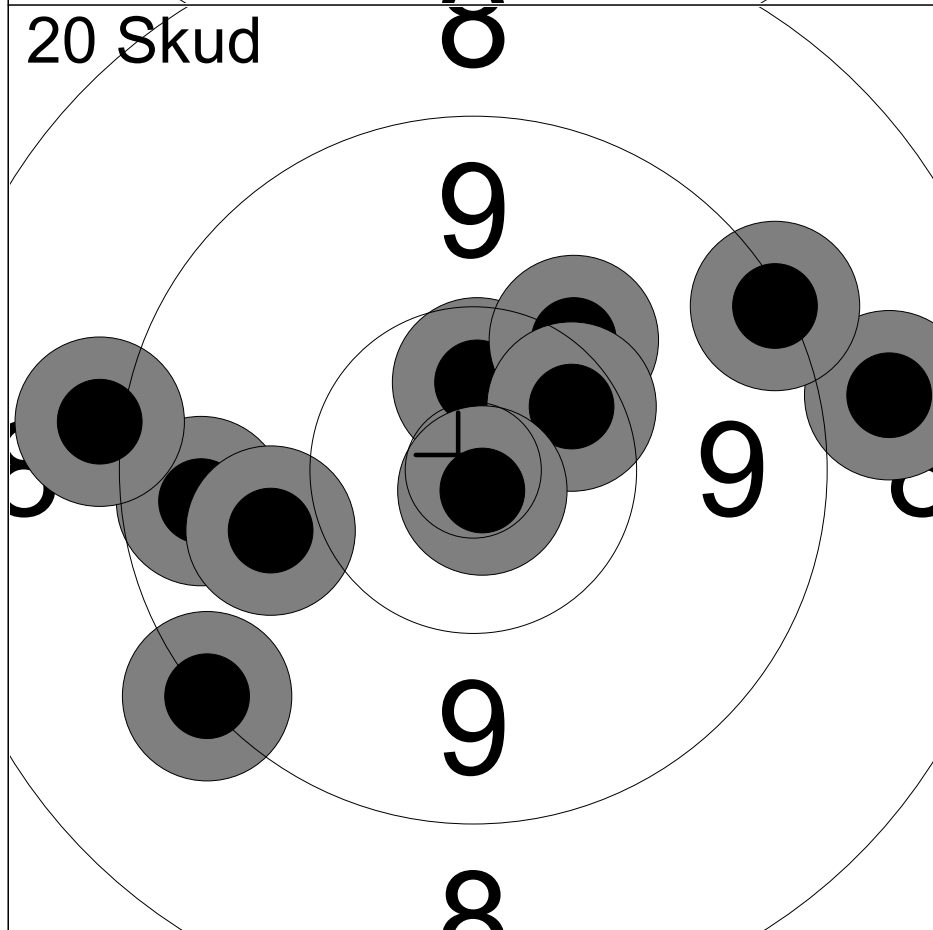

11:	9.2	↖
12:	10.5x	↗
13:	10.2	↗
14:	9.6	↖
15:	9.9	↖
16:	10.4	↗
17:	8.8	→
18:	10.8x	↘
19:	9.2	↗
20:	9.1	↖
Serie		93 ( 2x)
Total		192 ( 7x)

Hold <b>20</b>	Skive <b>7</b>	<b>Michael Pedersen</b>		
50m		Frederikssund Skytteforening, I	SE2	
09.08.2025		EM 2025	Hanebjerg Skyttecenter	
Kommentar		Signatur		

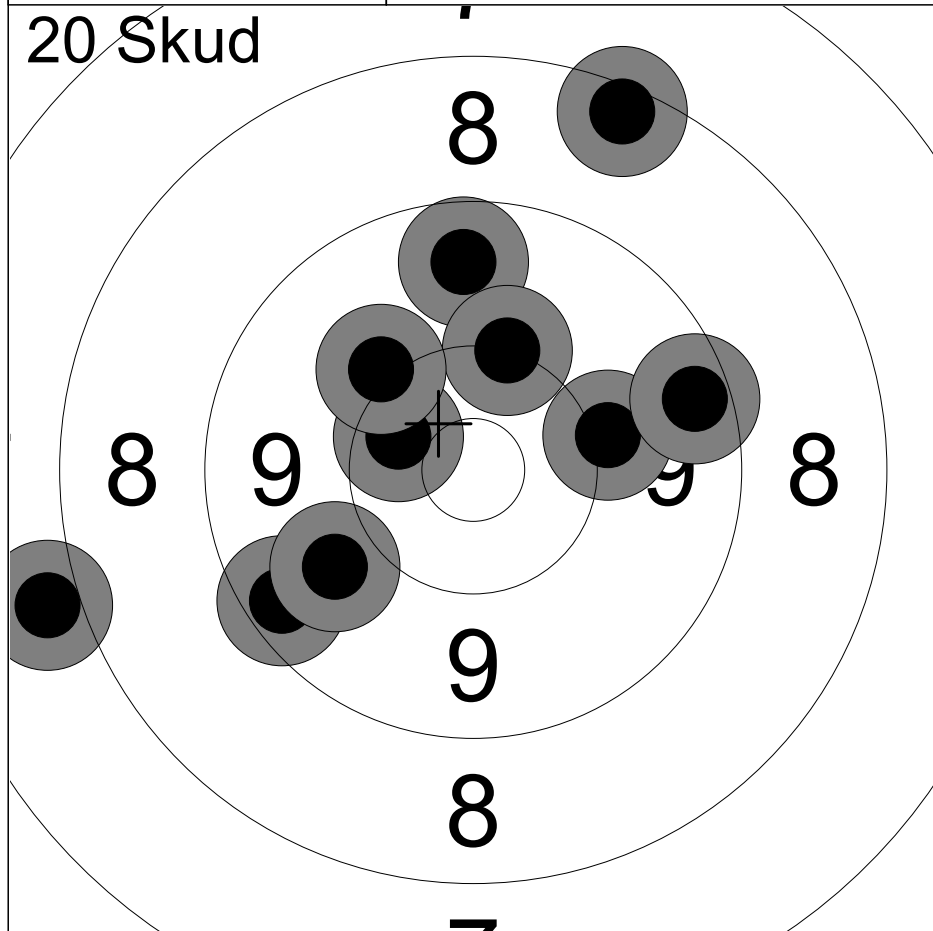

1:	8.4	↗
2:	10.1	→
3:	9.6	↑
4:	9.4	↙
5:	10.2	↑
6:	10.4x	↙
7:	7.9	↙
8:	10.1	↗
9:	9.4	→
10:	9.9	↙
Serie		91 ( 1x)
Total		91 ( 1x)

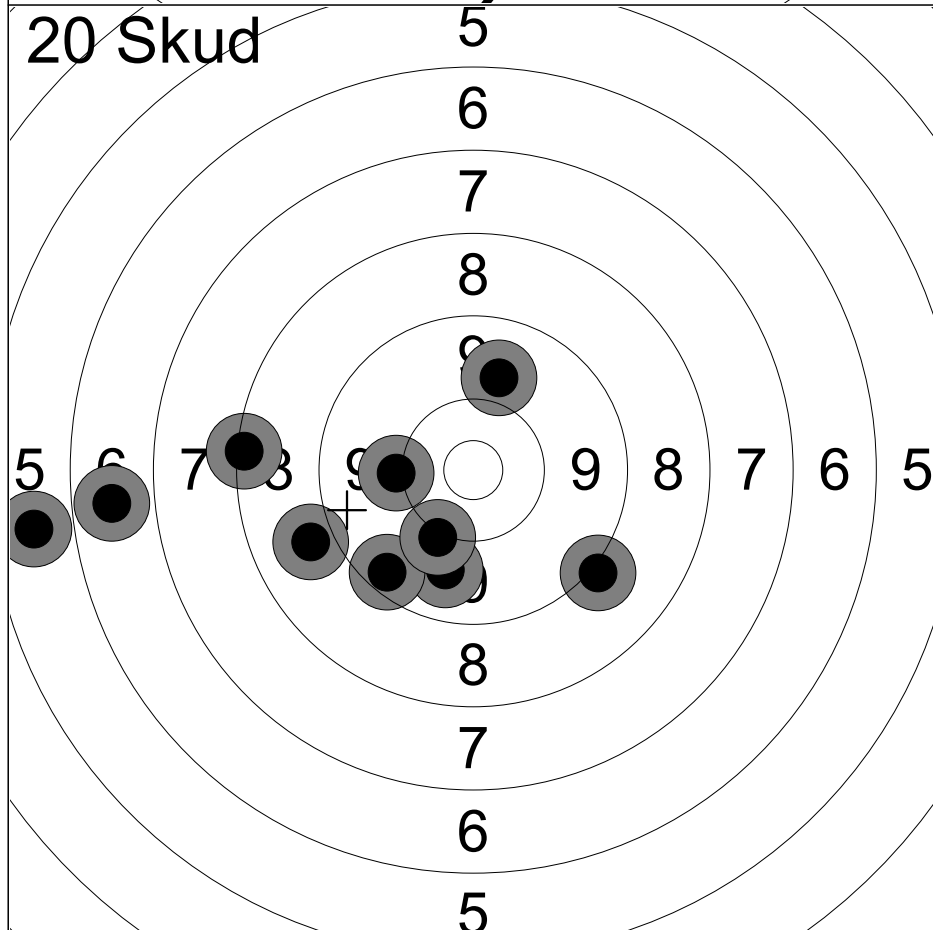

11:	9.9	↑
12:	10.1	↙
13:	8.9	↙
14:	8.3	↙
15:	6.7	↙
16:	9.1	↘
17:	9.8	↓
18:	9.4	↙
19:	10.1	↘
20:	5.7	↙
Serie		83 ( 0x)
Total		174 ( 1x)

Hold <b>20</b>	Skive <b>8</b>	<b>Jacob Frederiksen</b>	
50m	Frederikssund Skytteforening, I	Å2	
09.08.2025	EM 2025	Hanebjerg Skyttecenter	
Kommentar	Signatur		

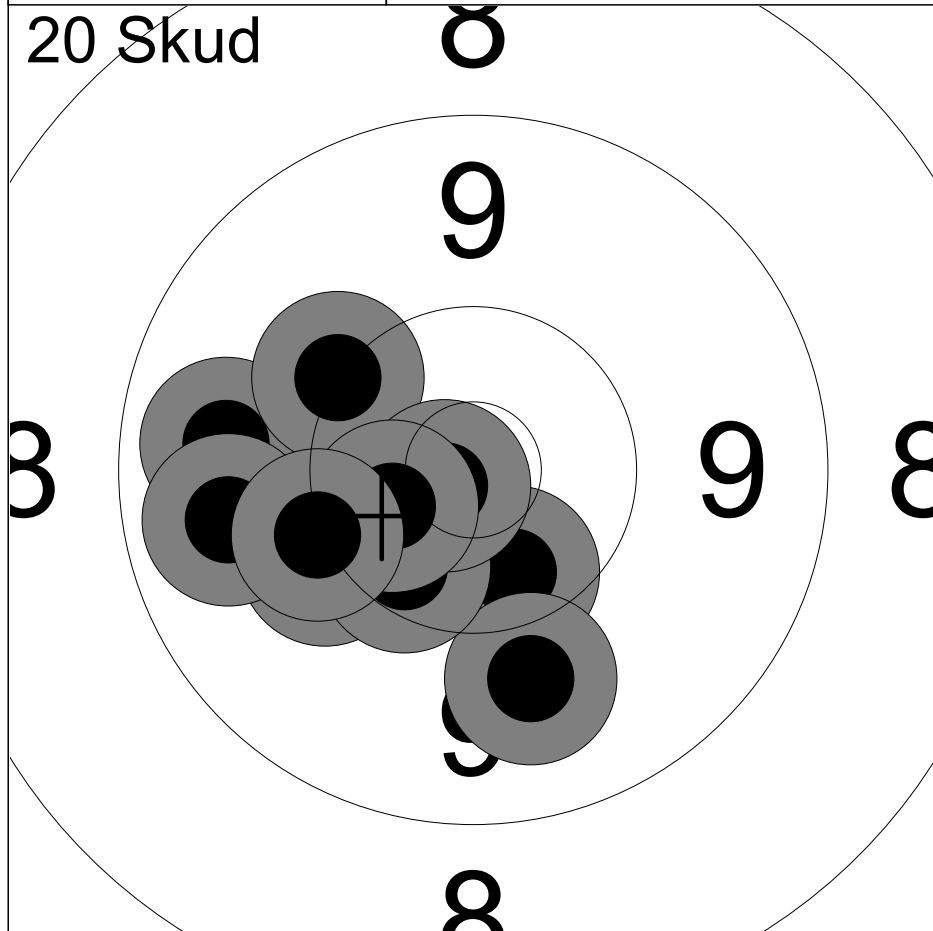

1:	10.1	←
2:	10.4x	↘
3:	9.7	←
4:	9.9	↘
5:	10.2	↗
6:	10.4	↘
7:	9.7	←
8:	10.8x	←
9:	10.5x	←
10:	10.1	←
Serie		97 ( 3x)
Total		97 ( 3x)

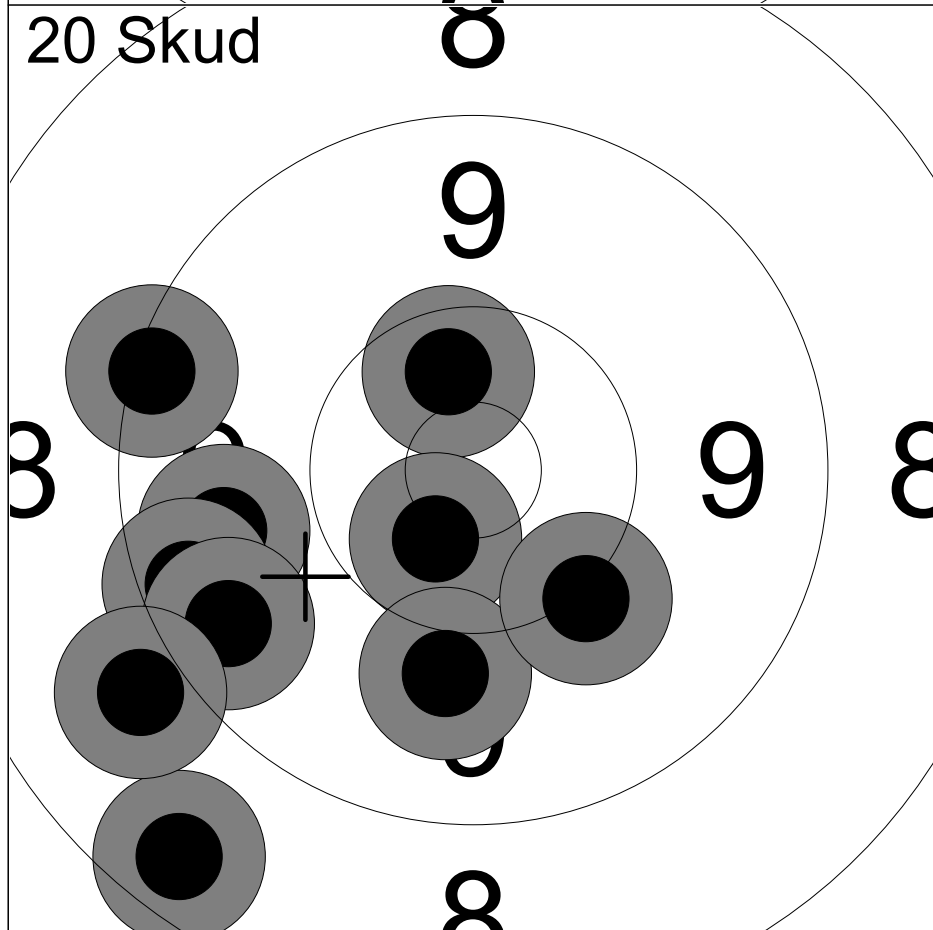

11:	9.7	←
12:	9.4	←
13:	9.3	←
14:	10.5x	↑
15:	9.5	←
16:	10.6x	↘
17:	10.0	↘
18:	10.1	↘
19:	8.5	↘
20:	8.9	↘
Serie		92 ( 2x)
Total		189 ( 5x)

Hold <b>20</b>	Skive <b>9</b>	<b>Erik Nissen</b>		
50m	Frederikssund Skytteforening, I		BK1	
09.08.2025	EM 2025	Hanebjerg Skyttecenter		
Kommentar	Signatur			

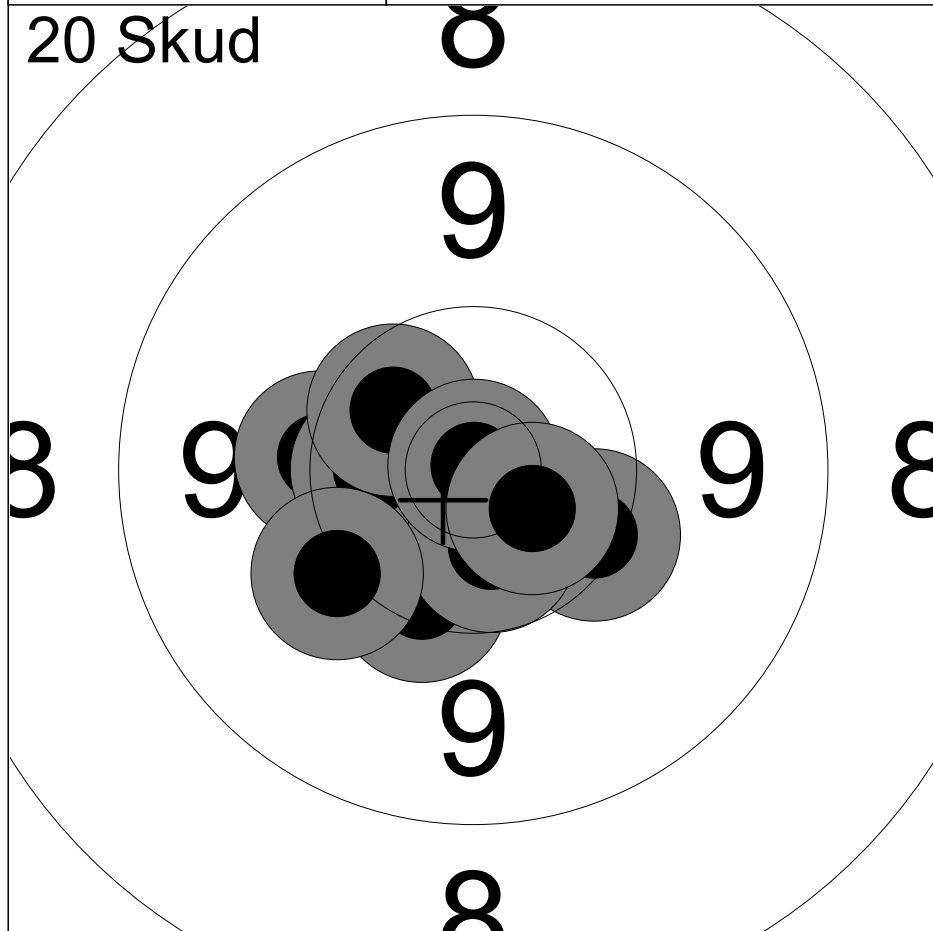

1:	10.2	←
2:	10.3	↘
3:	10.7x	↓
4:	10.3	↘
5:	10.5x	←
6:	10.6x	↓
7:	10.1	↙
8:	10.5x	↗
9:	10.9x	↑
10:	10.6x	↘
Serie		100 ( 6x)
Total		100 ( 6x)



11:	10.3	↘
12:	10.3	→
13:	10.6x	↗
14:	10.6x	→
15:	10.3	↘
16:	10.5x	←
17:	10.7x	↘
18:	10.3	↗
19:	10.7x	↘
20:	10.3	↖
Serie		100 ( 5x)
Total		200 (11x)

Hold <b>20</b>	Skive <b>10</b>	<b>Mathilde Maj Schou-Friis</b>	
50m		Frederikssund Skytteforening, I	BK1
09.08.2025		EM 2025	Hanebjerg Skyttecenter
Kommentar		Signatur	

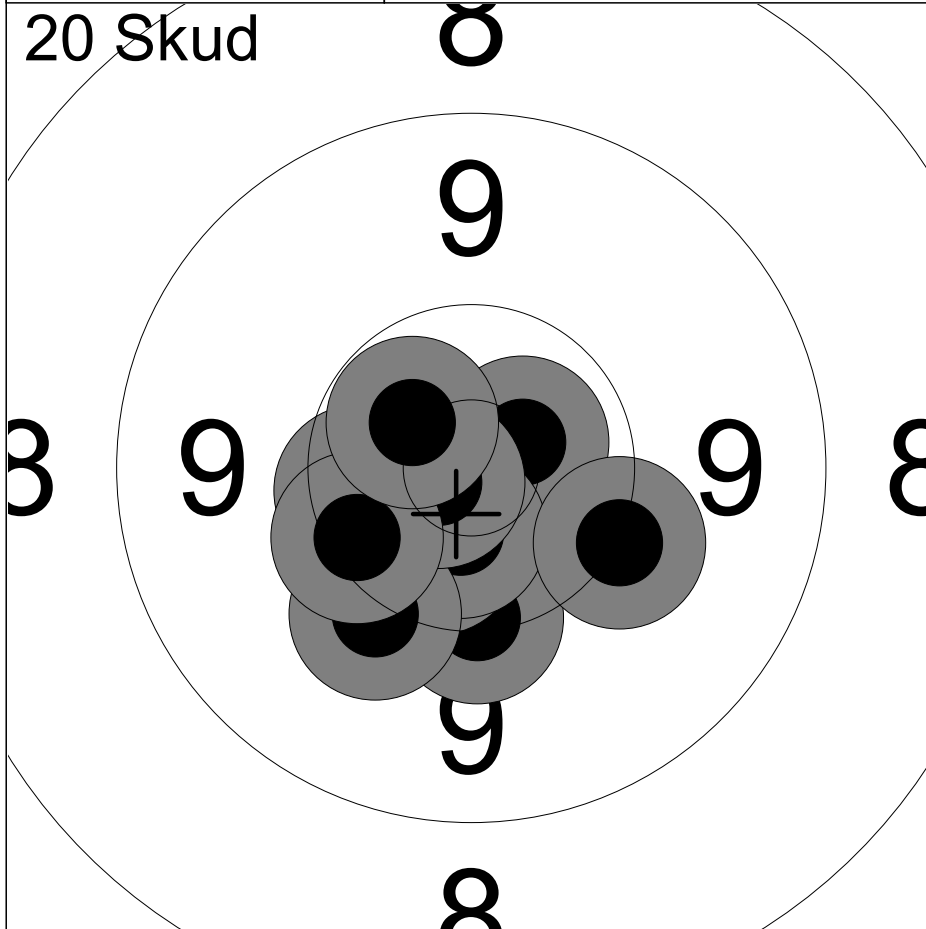

1:	10.4	←
2:	10.2	↓
3:	10.5x	↙
4:	10.7x	↗
5:	10.6x	↓
6:	10.1	↙
7:	10.8x	←
8:	10.3	←
9:	10.1	↘
10:	10.6x	↖
Serie		100 ( 5x)
Total		100 ( 5x)

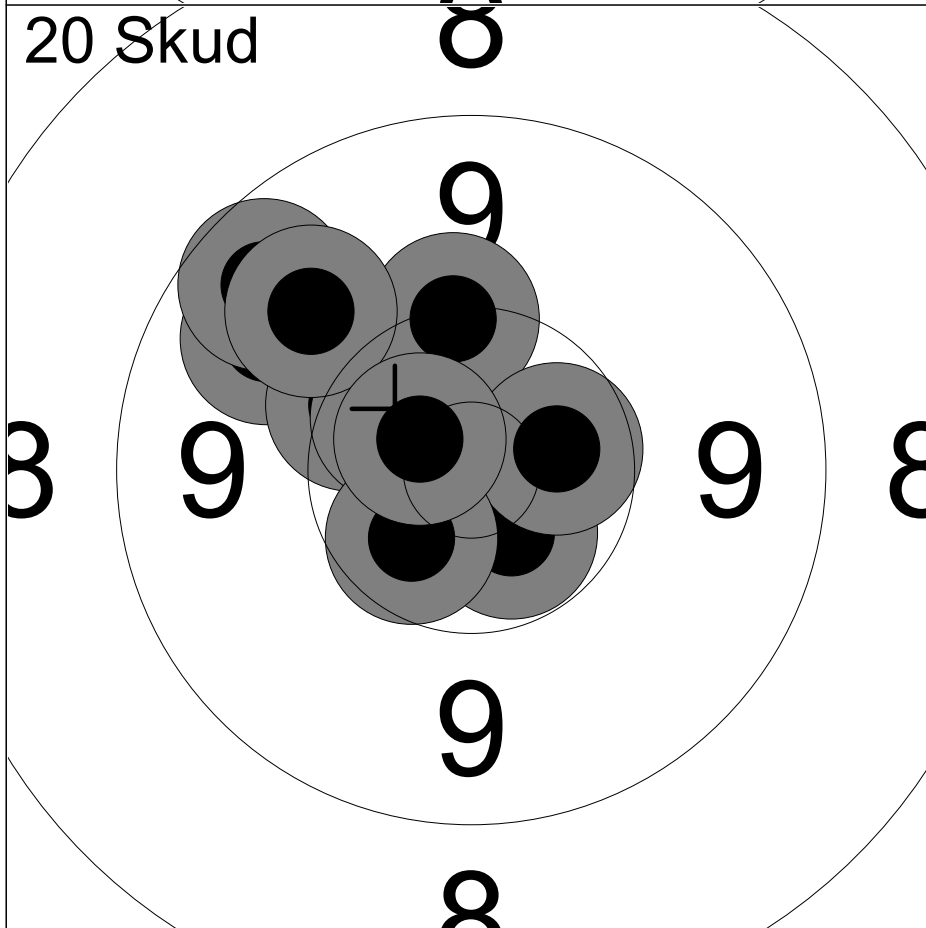

11:	9.8	↖
12:	10.6x	↘
13:	10.3	↖
14:	9.6	↖
15:	10.5x	↖
16:	10.2	↑
17:	10.5x	→
18:	9.8	↖
19:	10.5x	↙
20:	10.7x	↖
Serie		97 ( 5x)
Total		197 (10x)

Hold <b>20</b>	Skive <b>11</b>	<b>Sigurd Rasmussen</b>	
50m		Frederikssund Skytteforening, I	BK2
09.08.2025		EM 2025	Hanebjerg Skyttecenter
Kommentar		Signatur	

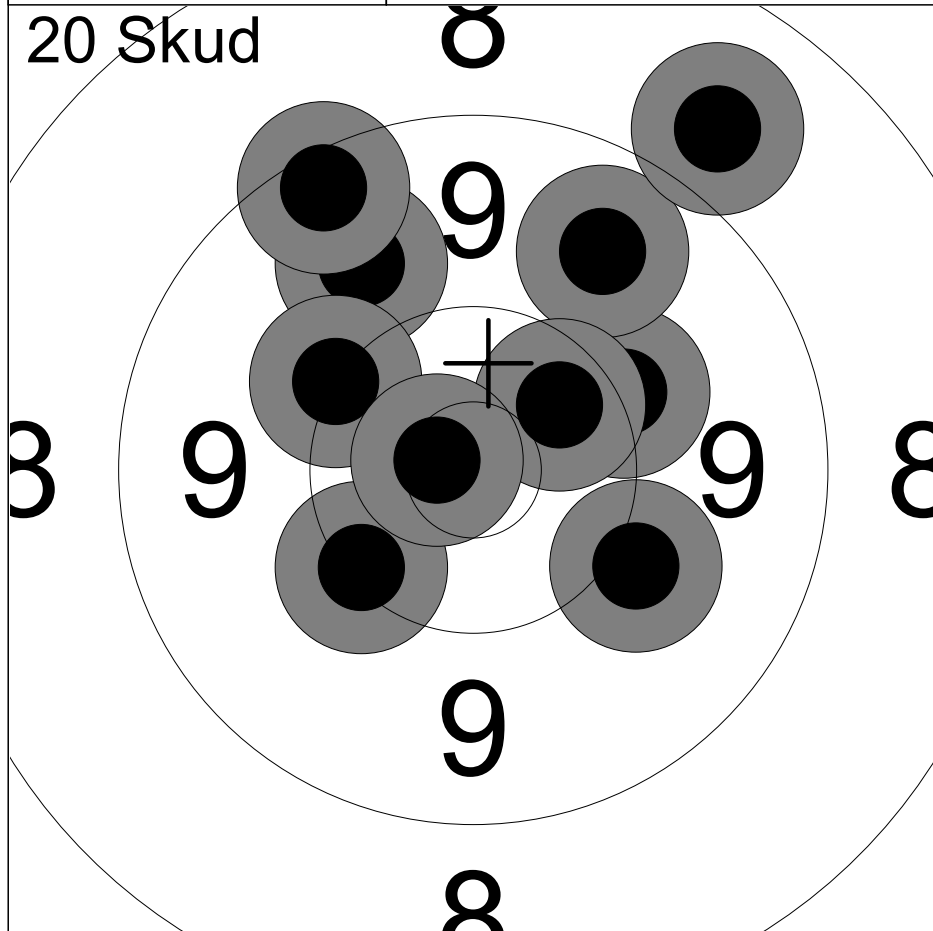

1:	10.2	↙
2:	10.1	↗
3:	10.0	↘
4:	9.7	↗
5:	8.8	↗
6:	10.4x	↗
7:	9.8	↗
8:	9.4	↗
9:	10.2	↗
10:	10.8x	↖
Serie		95 ( 2x)
Total		95 ( 2x)

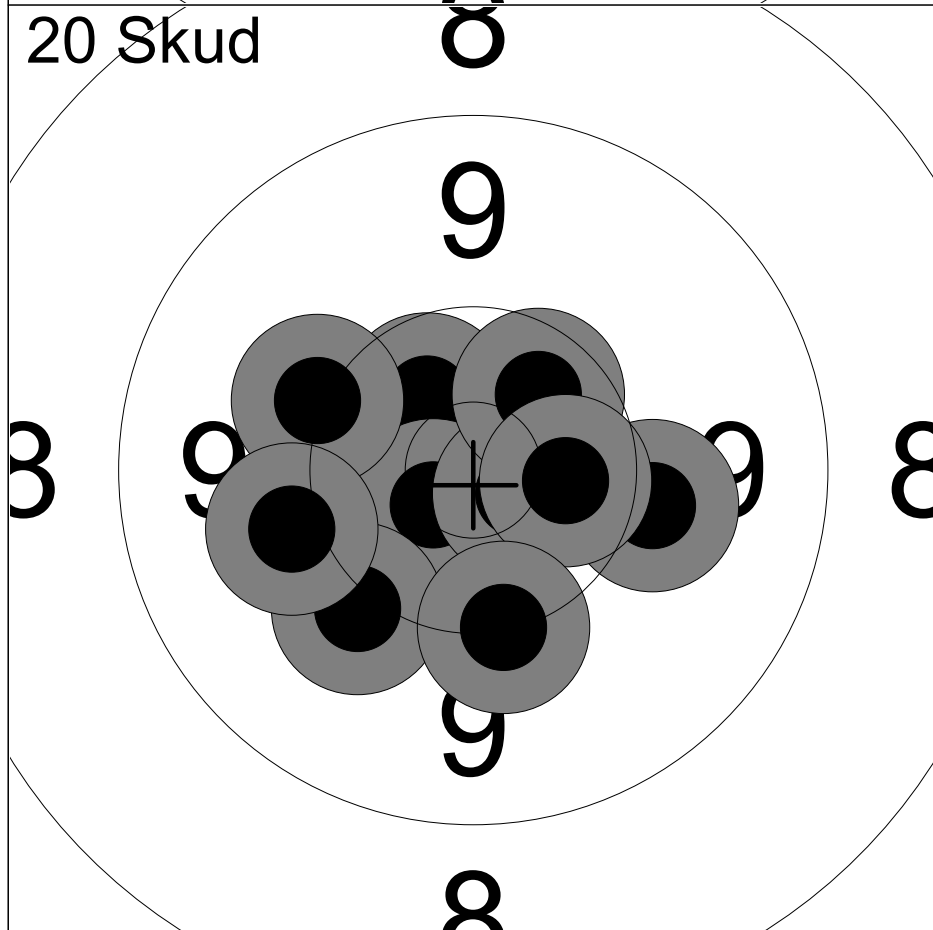

11:	10.5x	↗
12:	10.7x	↙
13:	10.7x	↘
14:	10.5x	↗
15:	10.1	↖
16:	10.1	→
17:	10.1	↙
18:	10.0	↙
19:	10.5x	→
20:	10.2	↘
Serie		100 ( 5x)
Total		195 ( 7x)

Hold <b>20</b>	Skive <b>12</b>	<b>Charlie Alexander Mouritsen</b>	
50m	Frederikssund Skytteforening, I	J2	
09.08.2025	EM 2025	Hanebjerg Skyttecenter	
Kommentar	Signatur		

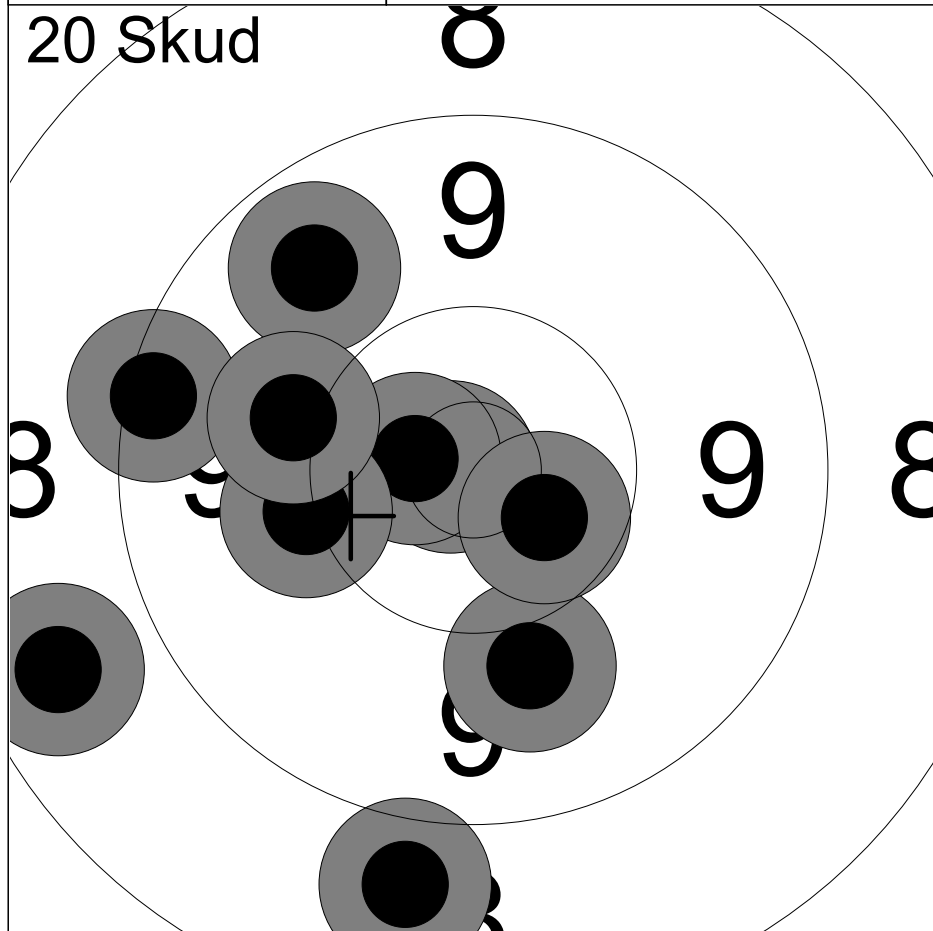

1:	10.8x	←
2:	10.7x	←
3:	10.0	↓
4:	9.3	←
5:	10.5x	↓
6:	10.1	←
7:	9.7	↗
8:	10.0	←
9:	8.8	↓
10:	8.6	←

Serie	94 ( 3x)
Total	94 ( 3x)

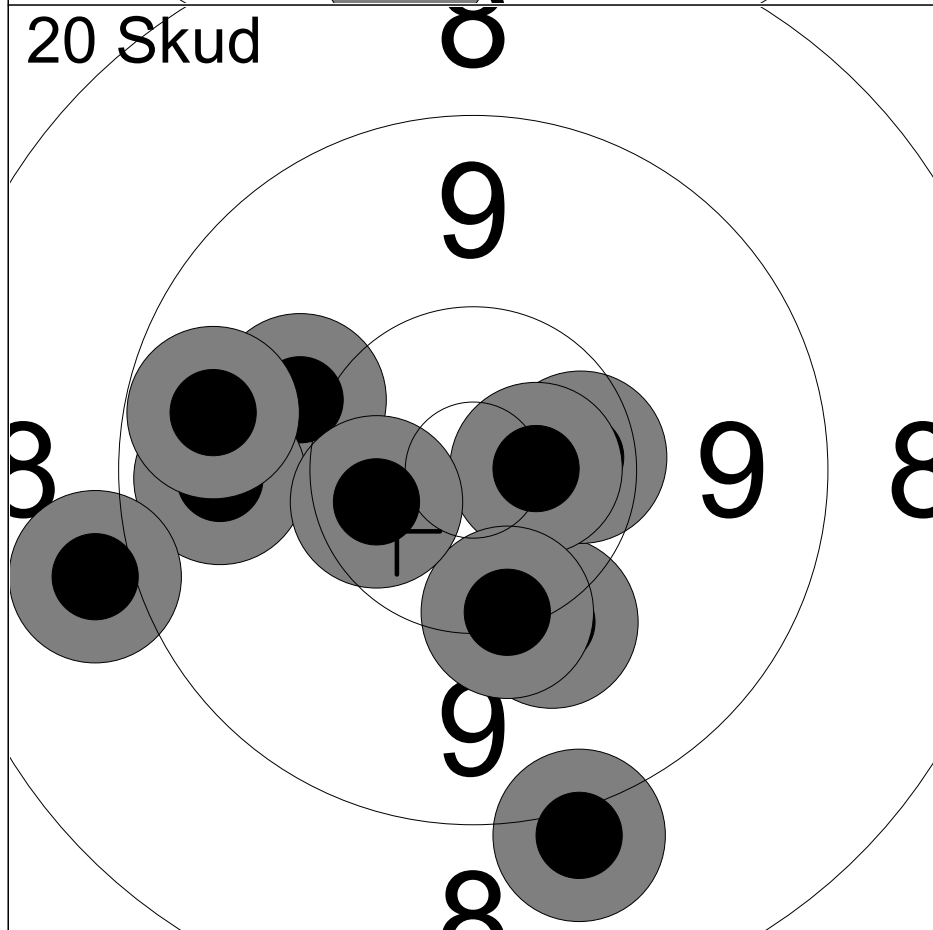

11:	10.0	←
12:	10.1	↓
13:	10.4x	→
14:	9.7	←
15:	9.0	←
16:	9.0	↓
17:	10.6x	→
18:	10.2	↓
19:	9.6	←
20:	10.5x	←

Serie	96 ( 3x)
Total	190 ( 6x)

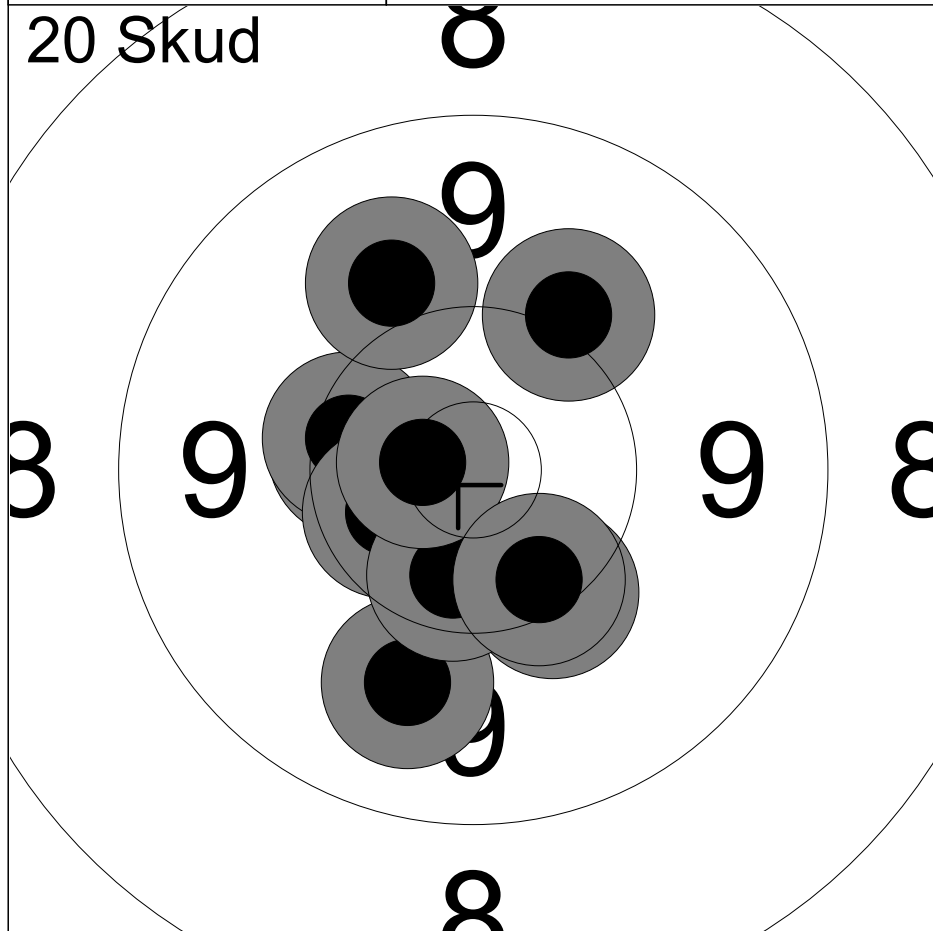

1:	10.4	←
2:	9.9	↓
3:	10.3	←
4:	10.5x	←
5:	10.1	↗
6:	10.2	↓
7:	10.0	↗
8:	10.4x	↓
9:	10.7x	←
10:	10.3	↓

Serie	99 ( 3x)
Total	99 ( 3x)

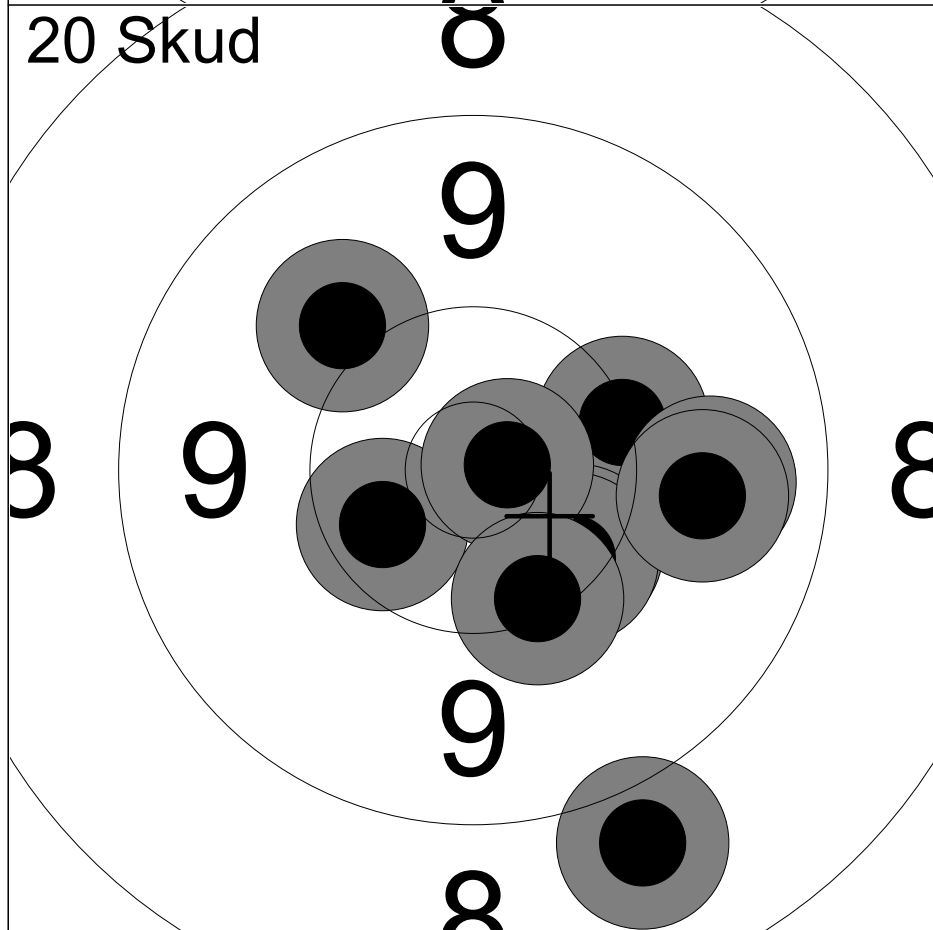

11:	10.4x	←
12:	10.0	↗
13:	8.9	↓
14:	10.2	↗
15:	10.3	↓
16:	10.3	↓
17:	10.8x	→
18:	9.8	→
19:	10.3	↓
20:	9.8	→

Serie	96 ( 2x)
Total	195 ( 5x)

Hold <b>21</b>	Skive <b>3</b>	<b>Viktor Lund-Vogensen</b>	
50m	Ganløse Skytteforening	J2	
09.08.2025	EM 2025	Hanebjerg Skyttecenter	
Kommentar	Signatur		

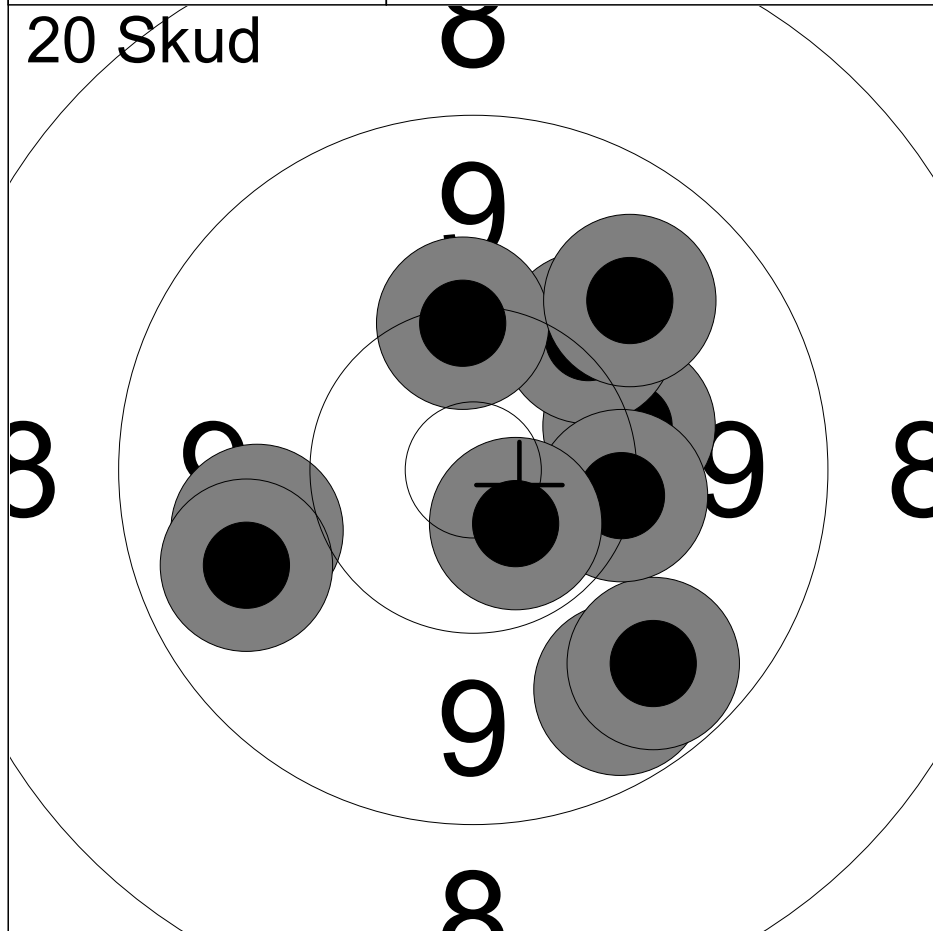

1:	10.2	→
2:	9.9	←
3:	9.6	↘
4:	9.6	↘
5:	10.1	↗
6:	9.7	←
7:	10.2	↑
8:	9.8	↗
9:	10.2	→
10:	10.6x	↘
Serie		95 ( 1x)
Total		95 ( 1x)

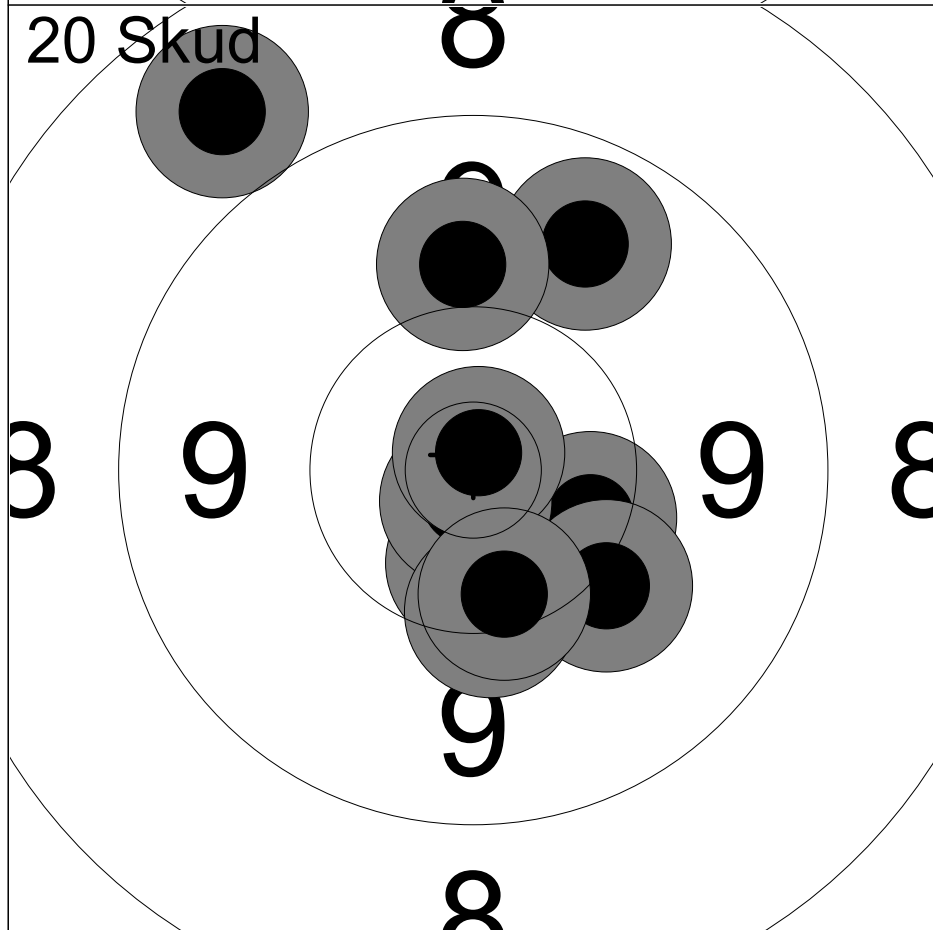

11:	10.5x	↓
12:	10.3	→
13:	10.8x	↘
14:	8.7	↗
15:	10.1	↘
16:	10.9x	↑
17:	9.7	↗
18:	10.0	↑
19:	10.3	↓
20:	10.3	↓
Serie		97 ( 3x)
Total		192 ( 4x)

Hold <b>21</b>	Skive <b>4</b>	<b>Frederik Lund-Vogensen</b>	
50m		Ganløse Skytteforening	J2
09.08.2025		EM 2025	Hanebjerg Skyttecenter
Kommentar		Signatur	

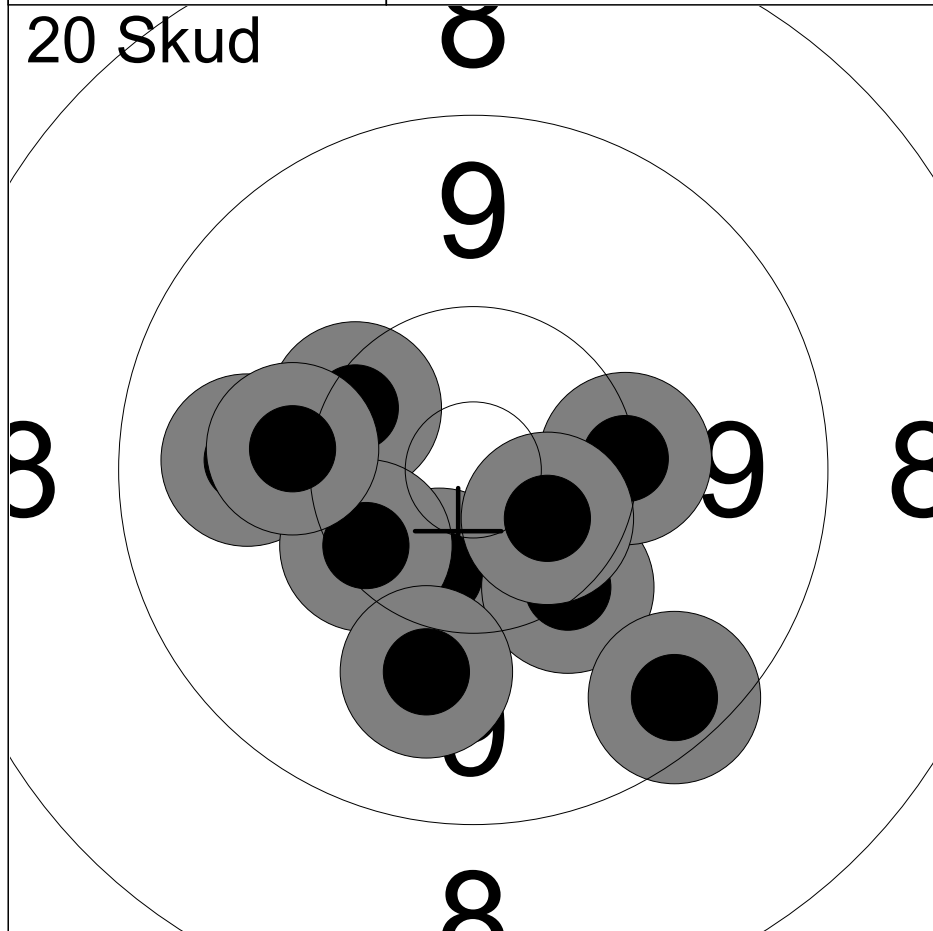

1:	10.4x	↘
2:	10.2	↘
3:	10.2	→
4:	9.8	←
5:	10.3	↗
6:	10.3	↖
7:	9.9	↘
8:	10.1	←
9:	9.4	↘
10:	10.5x	↘
Serie		97 ( 2x)
Total		97 ( 2x)

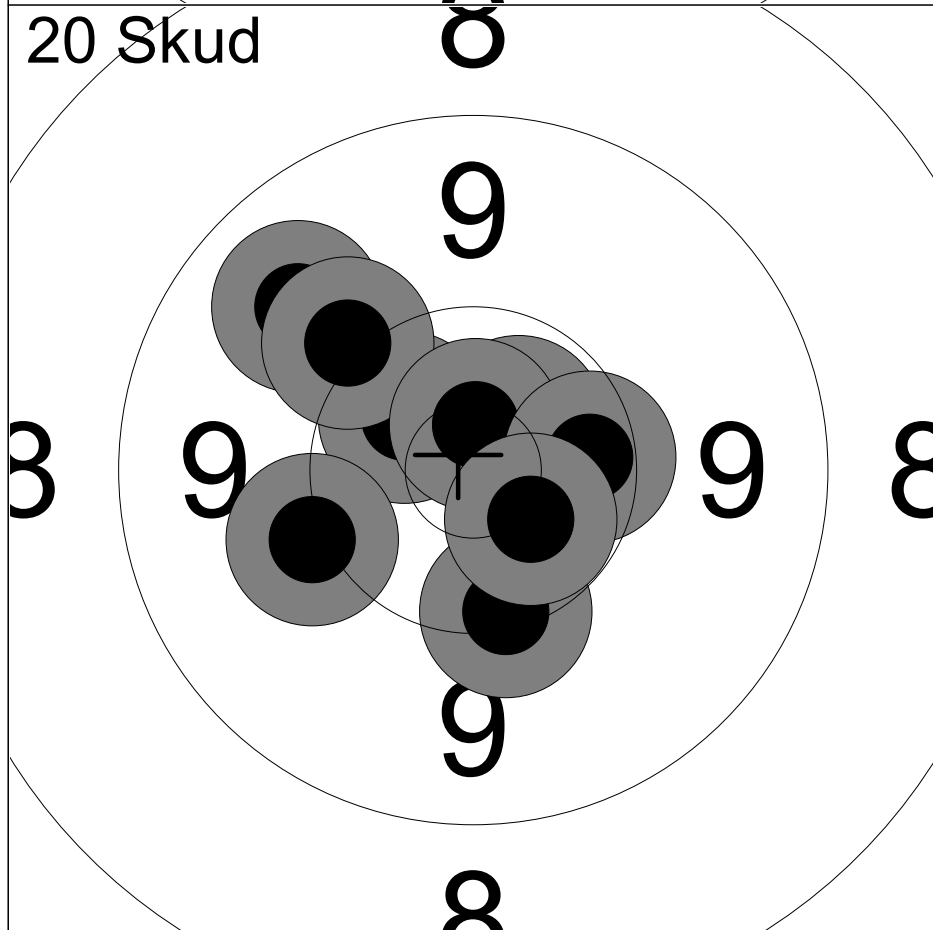

11:	10.7x	↗
12:	10.6x	↗
13:	10.5x	↗
14:	9.8	↗
15:	10.1	↗
16:	10.7x	↑
17:	10.2	↘
18:	10.4	→
19:	10.6x	↘
20:	10.1	←
Serie		99 ( 5x)
Total		196 ( 7x)

Hold <b>21</b>	Skive <b>6</b>	<b>Villads Jespersen</b>		
50m	Kreds 57, Ferslev, Skibby		MBK3	
09.08.2025	EM 2025	Hanebjerg Skyttecenter		
Kommentar	Signatur			

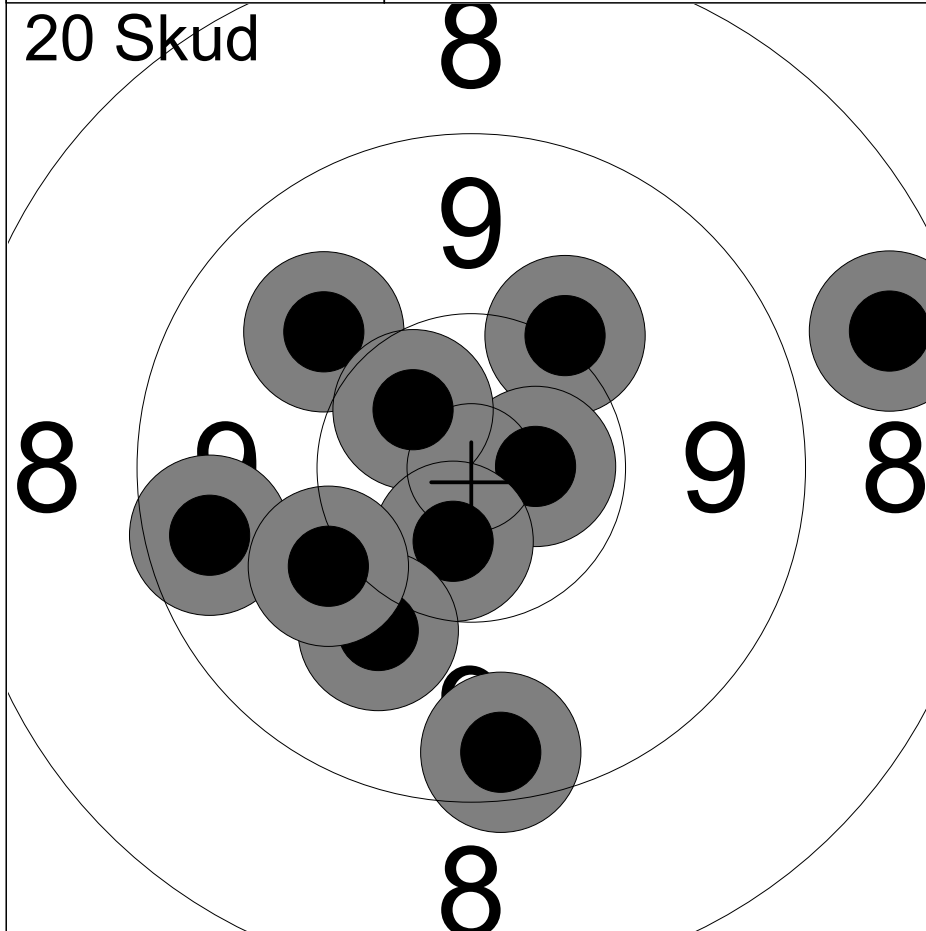

1:	9.9	↖
2:	10.1	↗
3:	10.6x	→
4:	9.5	←
5:	8.6	↗
6:	10.5x	↖
7:	10.6x	↓
8:	10.0	↙
9:	9.4	↓
10:	10.1	↙
Serie		95 ( 3x)
Total		95 ( 3x)

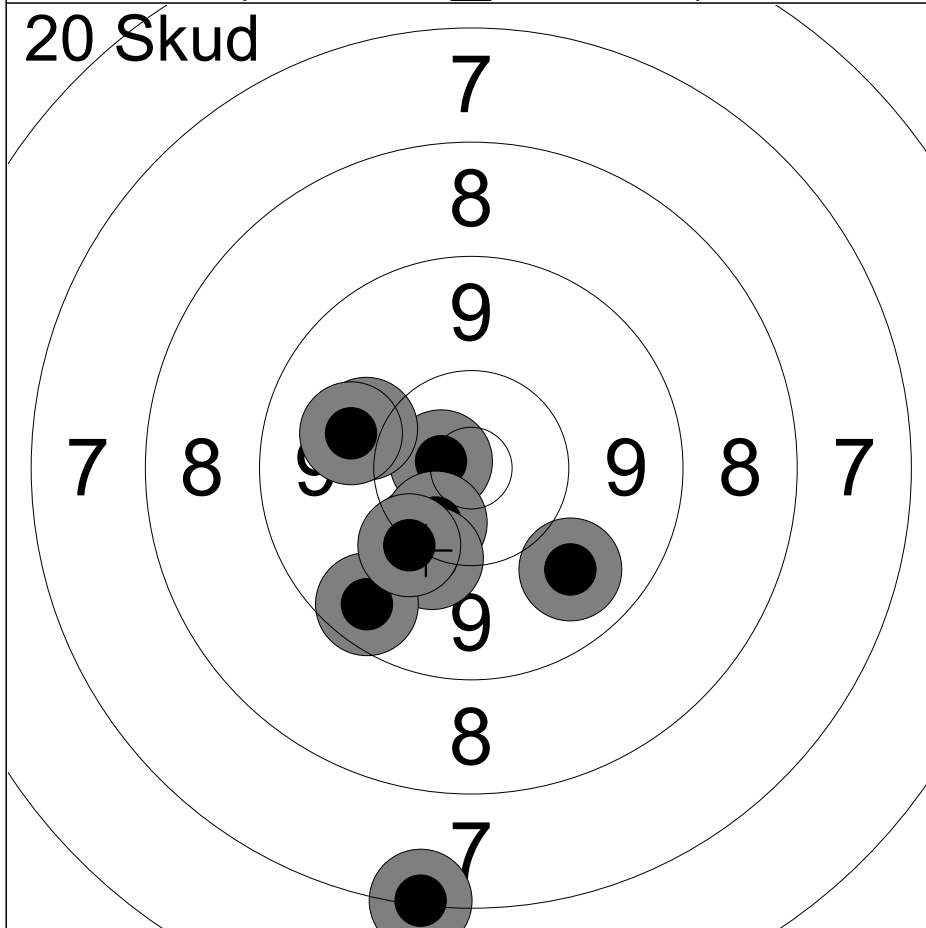

11:	10.7x	←
12:	10.3	↙
13:	10.4x	↙
14:	9.8	↘
15:	10.2	↙
16:	7.2	↓
17:	9.5	↙
18:	10.0	←
19:	10.1	↙
20:	9.9	←
Serie		94 ( 2x)
Total		189 ( 5x)

Hold <b>21</b>	Skive <b>8</b>	<b>Sara Aaslev Noerager Bay</b>		
50m	Ølstykke Skytteforening		J1	
09.08.2025	EM 2025	Hanebjerg Skyttecenter		
Kommentar	Signatur			

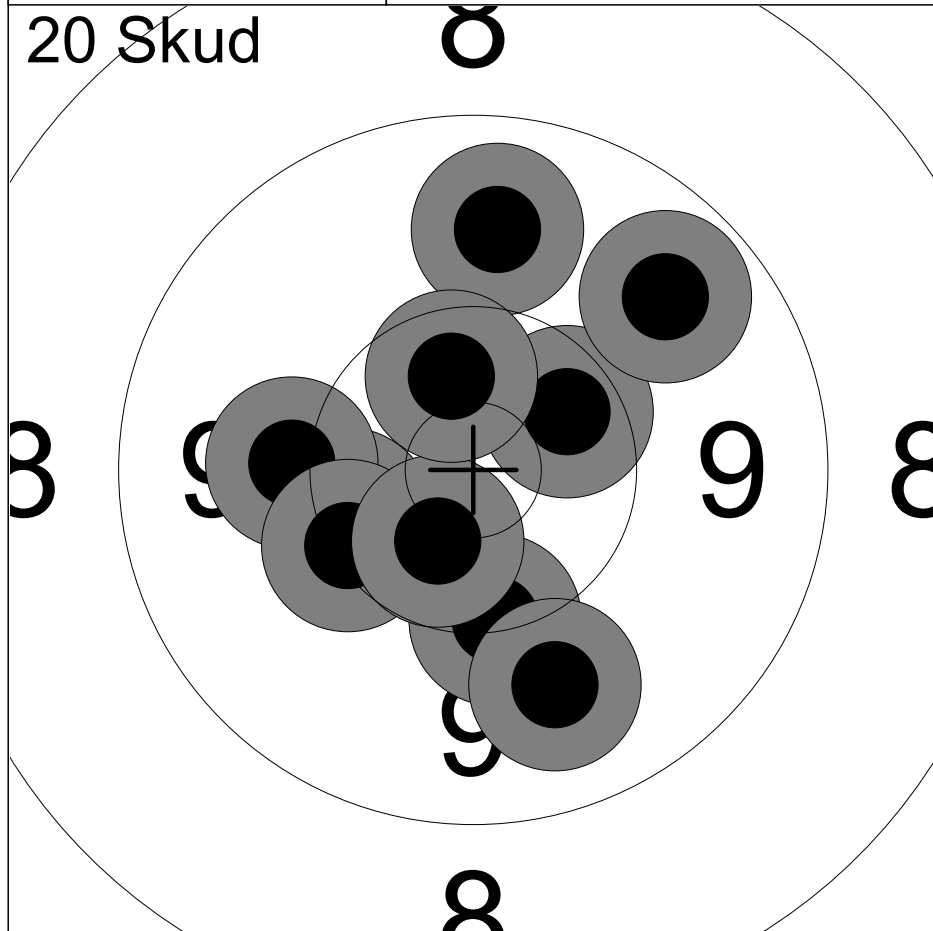

1:	10.4x	↗
2:	10.3	↖
3:	10.1	←
4:	10.2	↓
5:	10.2	↖
6:	9.7	↗
7:	9.8	↑
8:	10.6x	↙
9:	10.5x	↑
10:	9.8	↘
Serie		97 ( 3x)
Total		97 ( 3x)

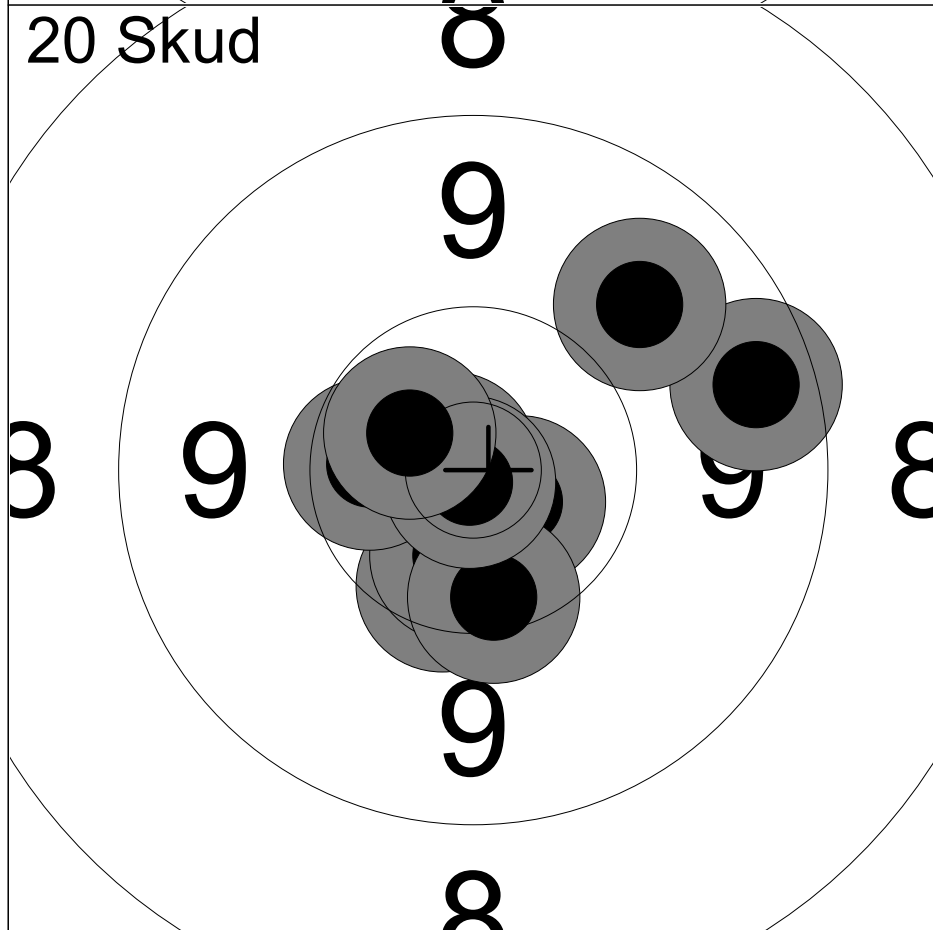

11:	10.4	↓
12:	9.5	→
13:	10.7x	↘
14:	9.8	↗
15:	10.5x	↓
16:	10.8x	↖
17:	10.4x	←
18:	10.3	↓
19:	10.9x	↙
20:	10.6x	↖
Serie		98 ( 6x)
Total		195 ( 9x)

Hold <b>21</b>	Skive <b>9</b>	<b>Cecilie Bugge Deichmann</b>	
50m	Ølstykke Skytteforening	Å1	
09.08.2025	EM 2025	Hanebjerg Skyttecenter	
Kommentar	Signatur		

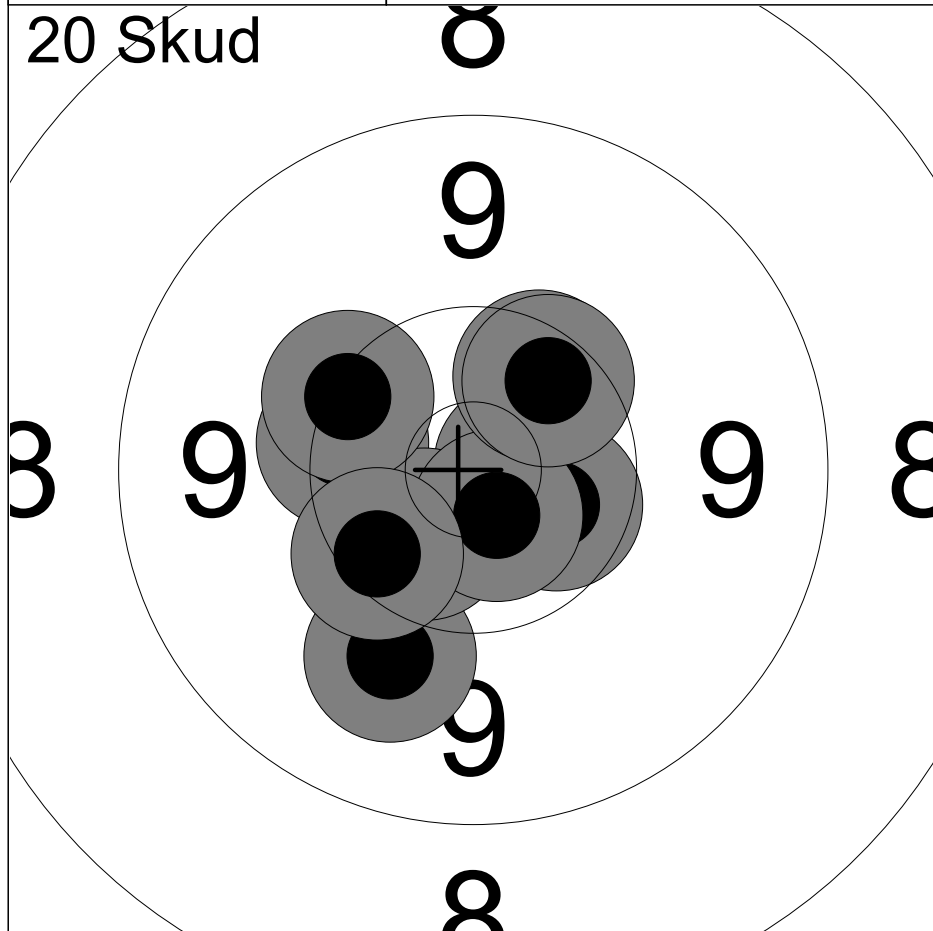

1:	10.7x	→
2:	10.3	←
3:	10.5x	→
4:	10.0	↘
5:	10.6x	↘
6:	10.7x	↘
7:	10.4	↗
8:	10.2	↖
9:	10.4	↗
10:	10.3	↙
Serie	100 ( 4x)	
Total	100 ( 4x)	

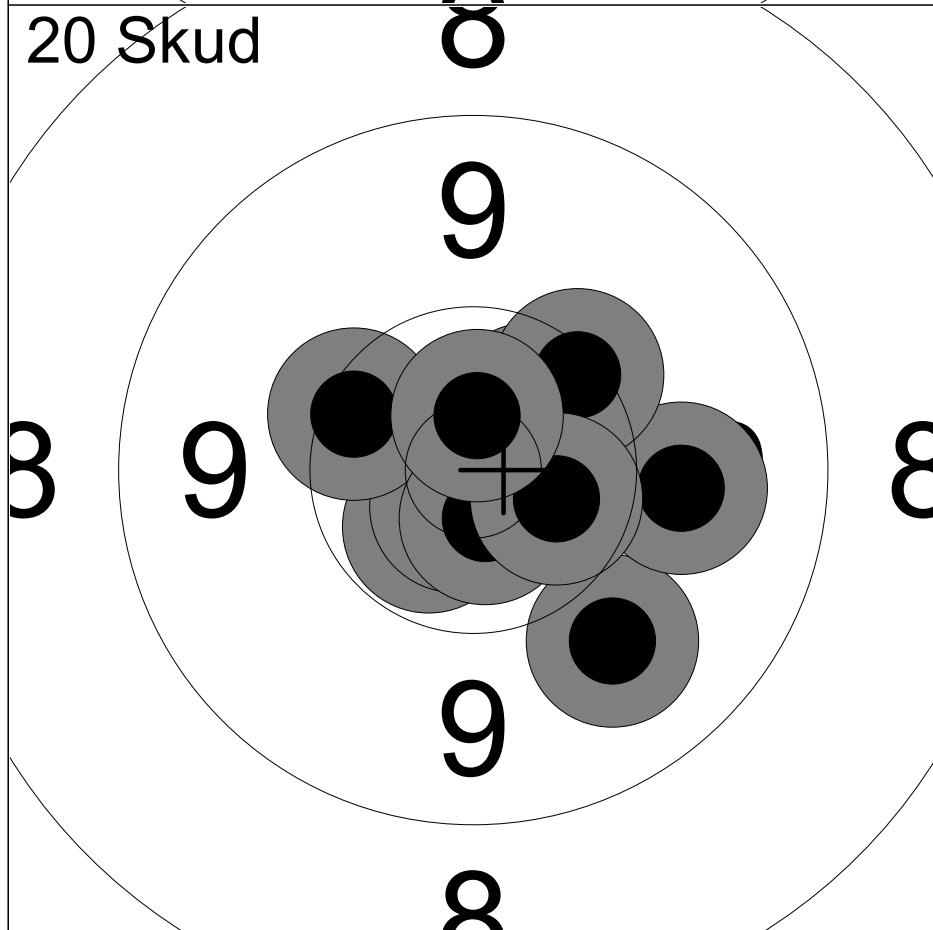

11:	10.6x	↙
12:	9.9	↘
13:	10.8x	↘
14:	9.9	→
15:	10.3	↖
16:	10.5x	↗
17:	10.3	↗
18:	10.7x	↘
19:	10.5x	→
20:	10.7x	↑
Serie	98 ( 6x)	
Total	198 (10x)	

Hold <b>21</b>	Skive <b>10</b>	<b>Magnus Bjoernberg Levisen</b>	
50m		Ølstykke Skytteforening	J1
09.08.2025		EM 2025	Hanebjerg Skyttecenter
Kommentar		Signatur	

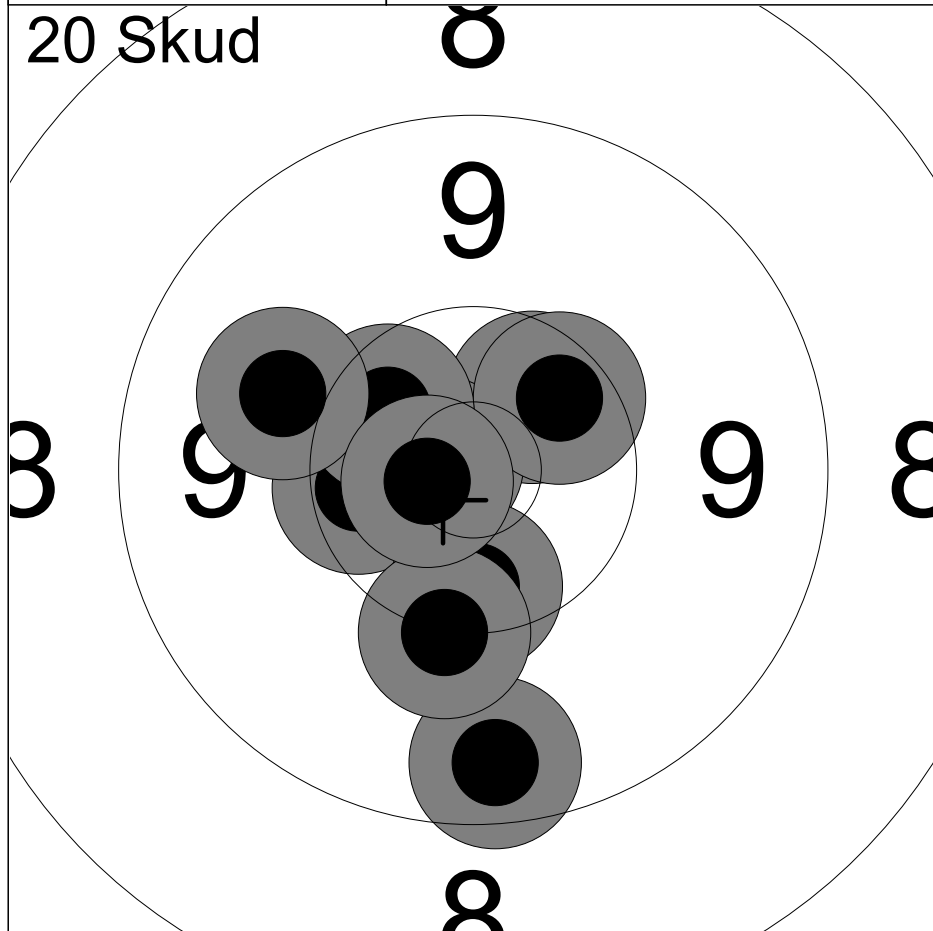

1:	10.5x	↗
2:	10.4	←
3:	10.8x	←
4:	9.5	↓
5:	10.4	↓
6:	10.4	↗
7:	10.4x	↗
8:	10.0	↖
9:	10.1	↓
10:	10.7x	←
Serie		99 ( 4x)
Total		99 ( 4x)

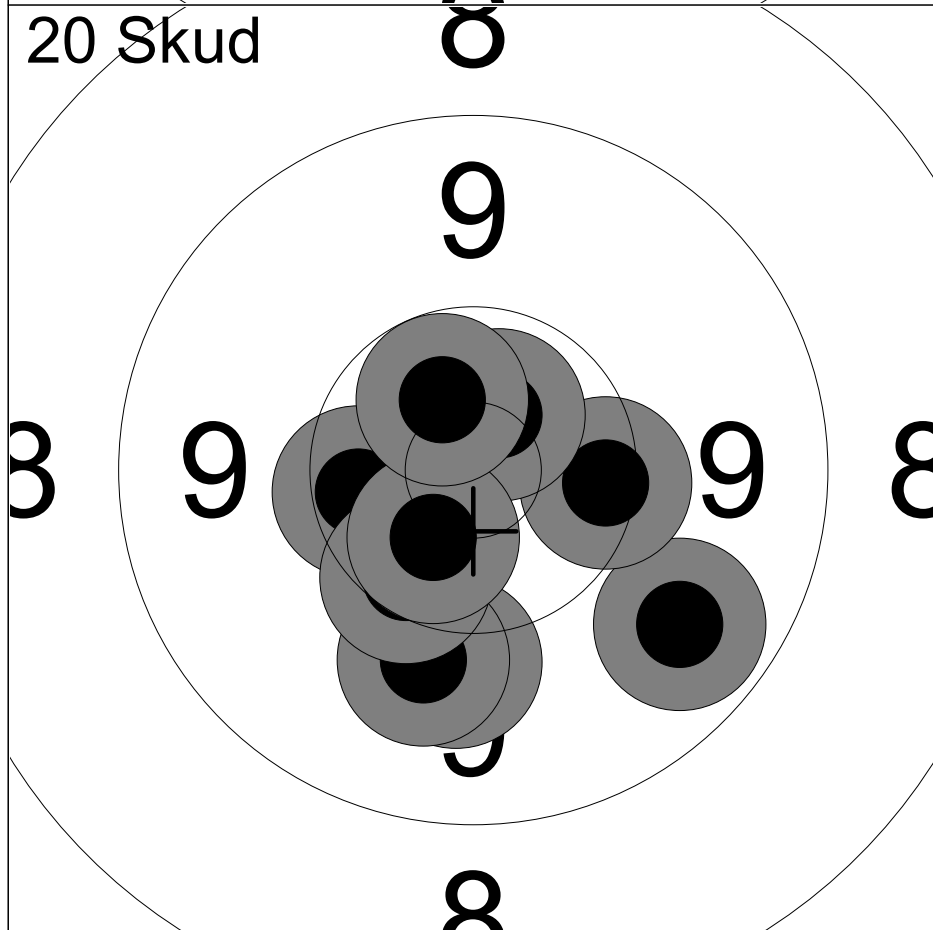

11:	10.5x	←
12:	10.4	←
13:	9.7	↘
14:	10.0	↓
15:	10.0	↓
16:	10.3	→
17:	10.3	↘
18:	10.7x	↗
19:	10.6x	↘
20:	10.6x	↖
Serie		99 ( 4x)
Total		198 ( 8x)

Hold <b>21</b>	Skive <b>11</b>	<b>Malou Schmidt-Larsen</b>	
50m		Ølstykke Skytteforening	J2
09.08.2025		EM 2025	Hanebjerg Skyttecenter
Kommentar		Signatur	

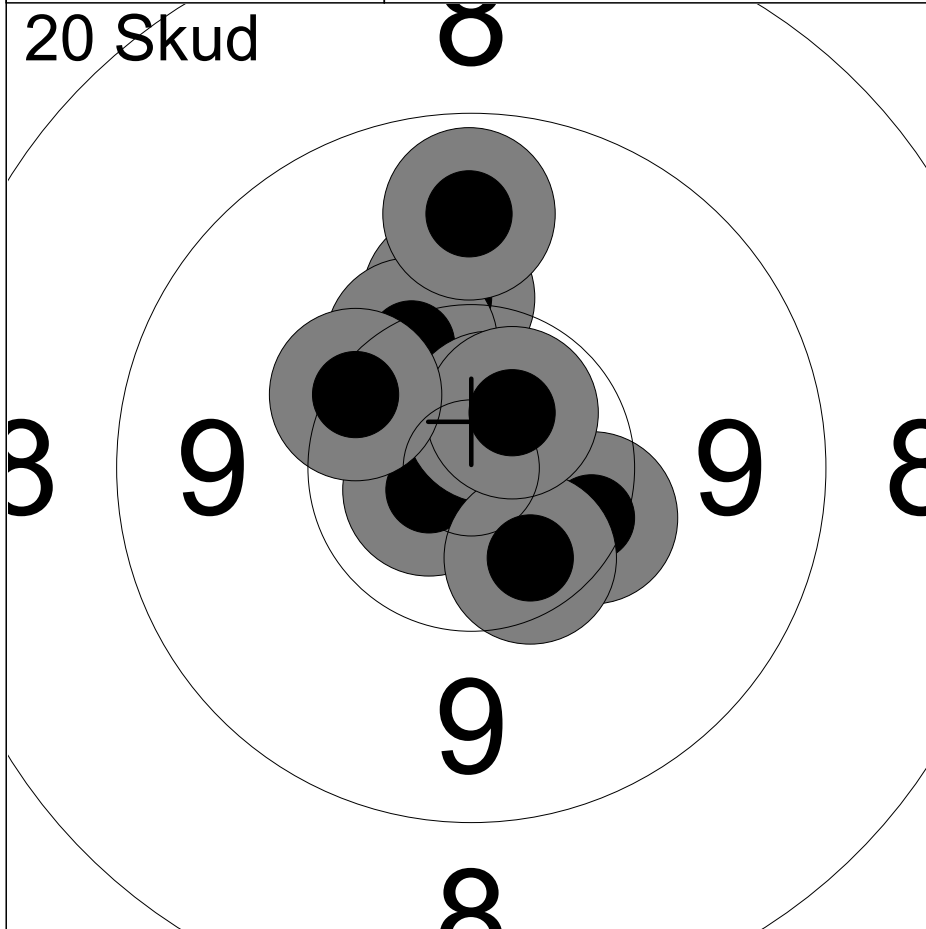

1:	10.5x	↘
2:	10.3	→
3:	10.1	↑
4:	10.7x	↙
5:	10.3	↗
6:	10.7x	↗
7:	10.4x	↘
8:	10.6x	↗
9:	10.3	↖
10:	9.7	↑
Serie		99 ( 5x)
Total		99 ( 5x)

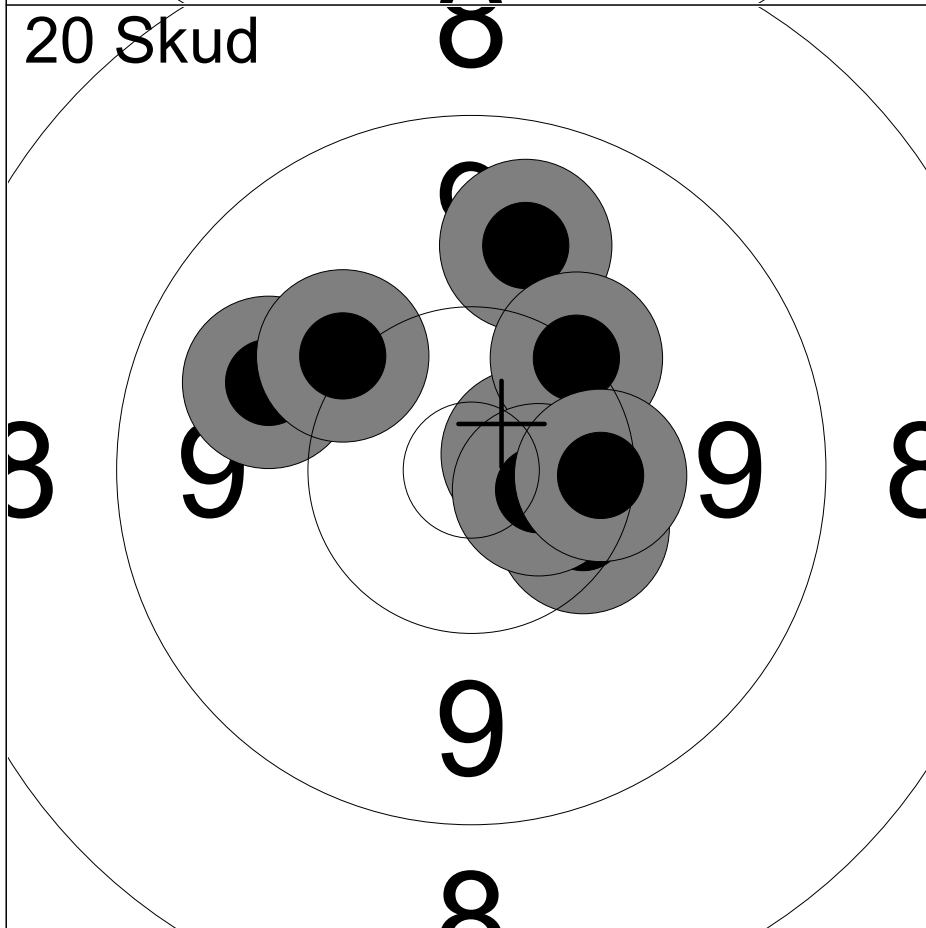

11:	10.5x	→
12:	10.7x	→
13:	9.8	↑
14:	10.5x	→
15:	10.2	↗
16:	10.3	↘
17:	10.6x	→
18:	10.3	→
19:	9.9	↗
20:	10.1	↖
Serie		98 ( 4x)
Total		197 ( 9x)

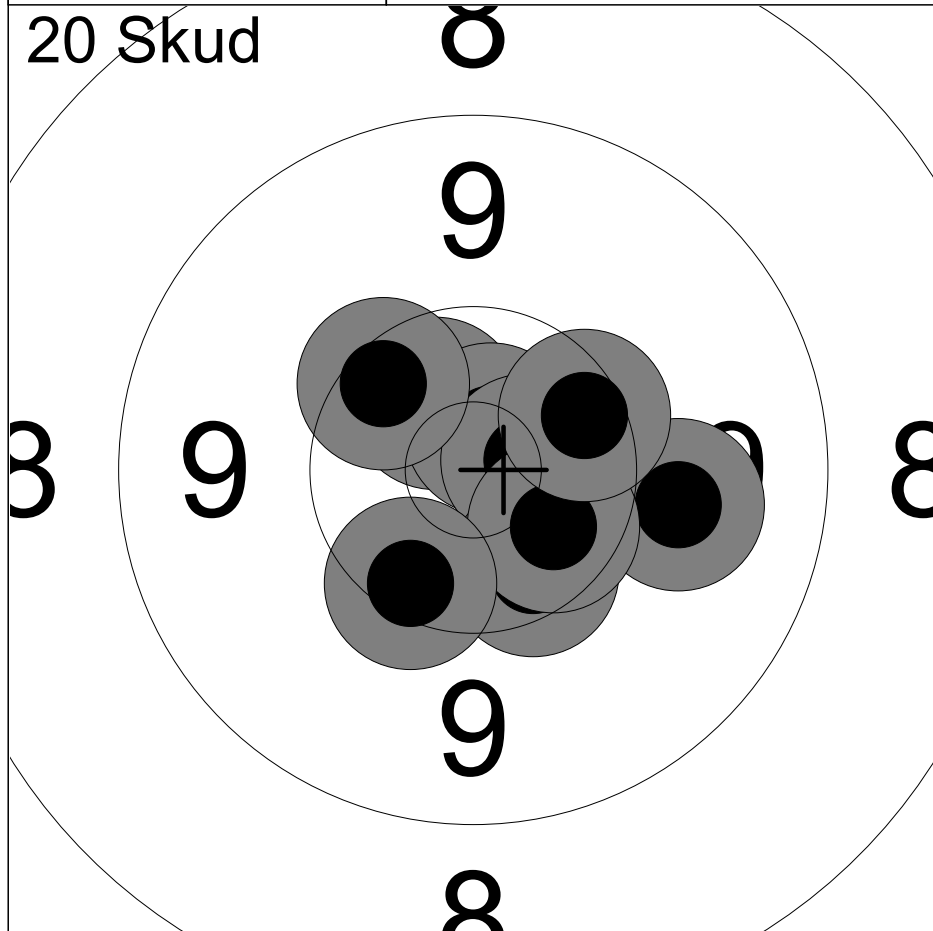

1:	10.6x	↖
2:	10.6x	↗
3:	10.7x	↖
4:	10.7x	↗
5:	9.9	↗
6:	10.4	↘
7:	10.5x	↘
8:	10.3	↖
9:	10.3	↗
10:	10.3	↘

Serie	99 ( 5x)
Total	99 ( 5x)



11:	10.4	↘
12:	10.7x	↖
13:	10.7x	↖
14:	10.1	↘
15:	10.2	↖
16:	10.5x	↘
17:	10.7x	↖
18:	10.4	↖
19:	10.5x	↗
20:	10.5x	↗

Serie	100 ( 6x)
Total	199 (11x)

Hold <b>22</b>	Skive <b>1</b>	<b>Amanda Jensen</b>	
50m	Kreds 57, Ferslev, Skibby	MJ1	
09.08.2025	EM 2025	Hanebjerg Skyttecenter	
Kommentar	Signatur		

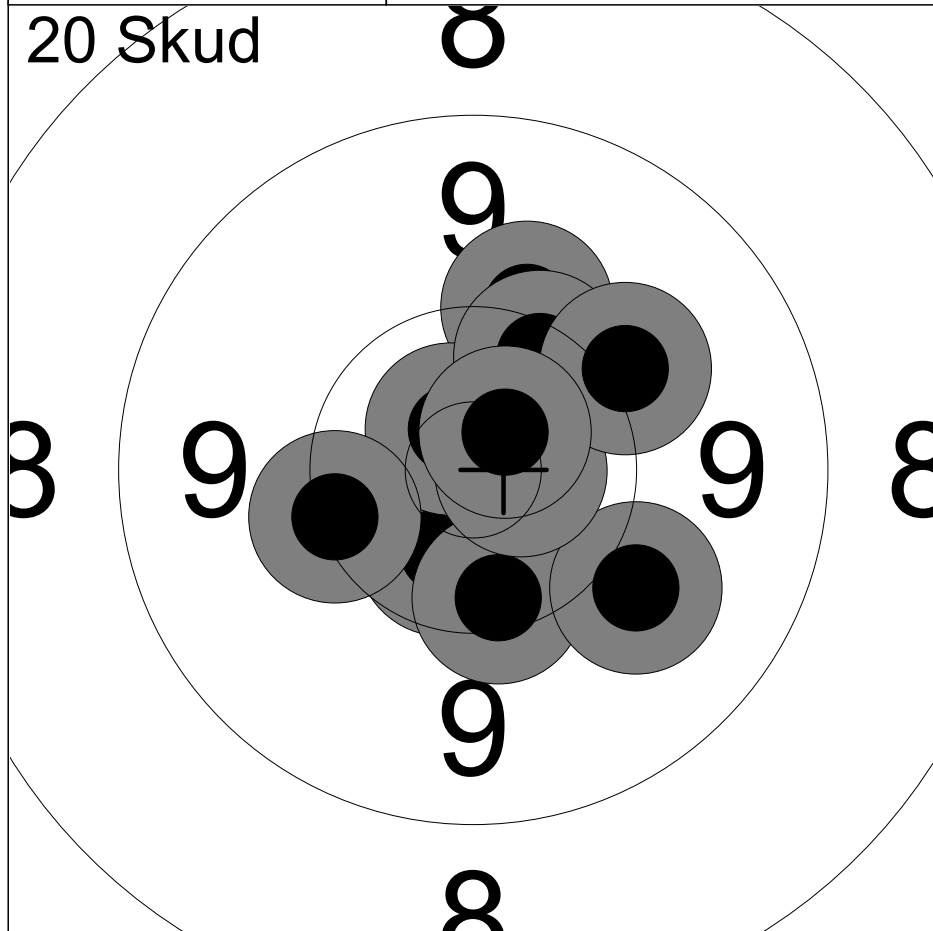

1:	10.5x	↙
2:	10.3	↘
3:	10.1	↗
4:	10.7x	↖
5:	10.0	↘
6:	10.3	↗
7:	10.2	←
8:	10.7x	→
9:	10.1	↗
10:	10.7x	↗
Serie	100 ( 4x)	
Total	100 ( 4x)	

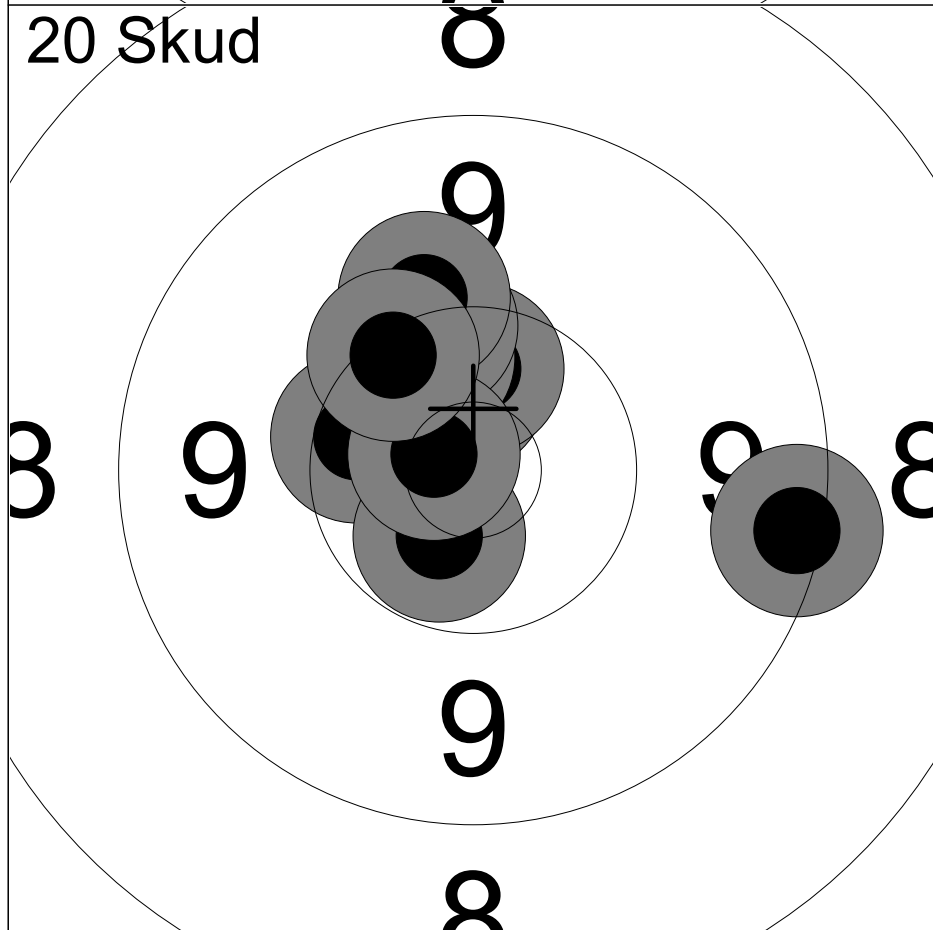

11:	10.4	←
12:	10.6x	↙
13:	10.5x	↗
14:	10.5x	↗
15:	10.4	↗
16:	10.2	↗
17:	9.3	→
18:	10.1	↗
19:	10.7x	↖
20:	10.3	↗
Serie	99 ( 4x)	
Total	199 ( 8x)	

Hold <b>22</b>	Skive <b>4</b>	<b>Mette Ea Schou-Friis</b>	
50m		Dauglykke Skytteforening	MST3
09.08.2025		EM 2025	Hanebjerg Skyttecenter
Kommentar		Signatur	

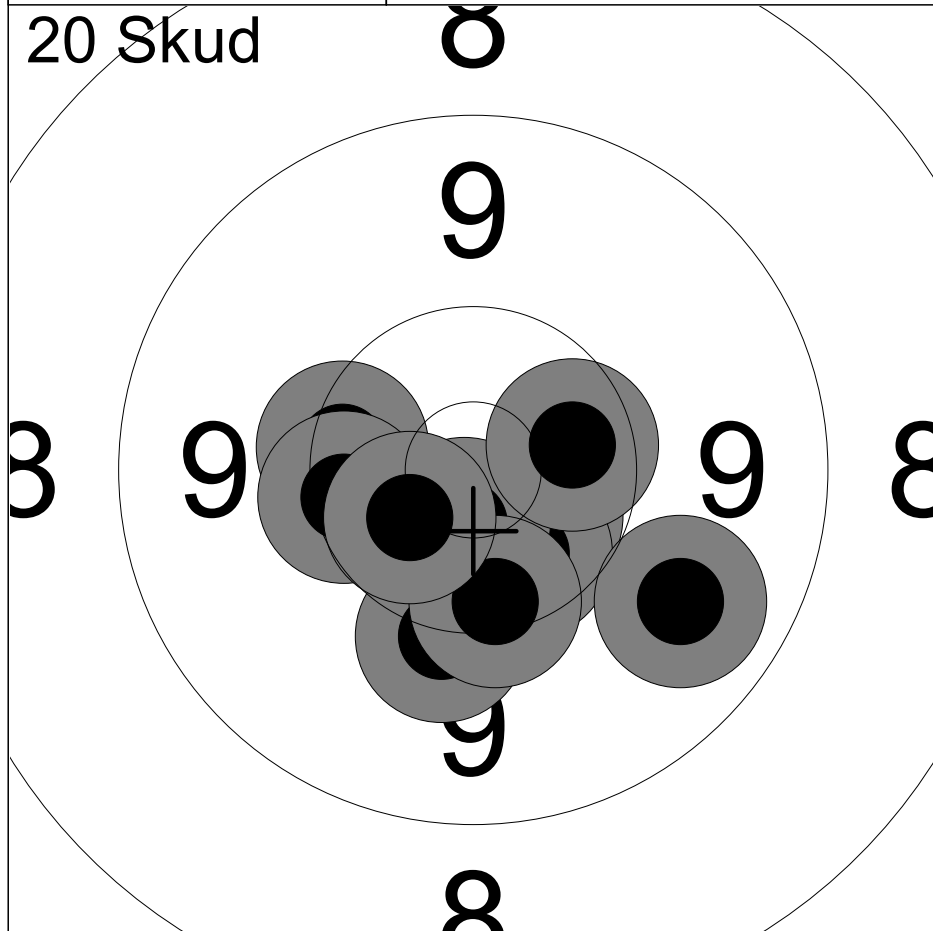

1:	10.3	←
2:	10.3	←
3:	10.6x	↘
4:	10.5x	↘
5:	10.7x	↘
6:	10.1	↘
7:	9.7	↘
8:	10.5x	→
9:	10.3	↘
10:	10.6x	↙
Serie		99 ( 5x)
Total		99 ( 5x)

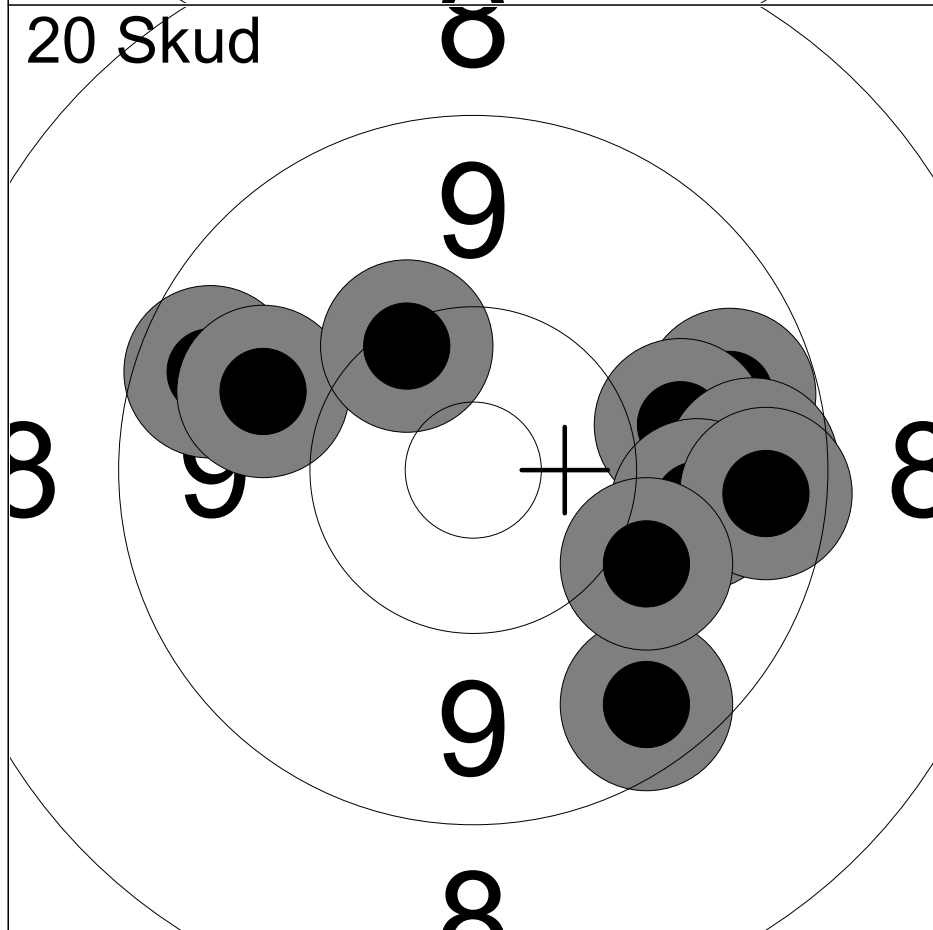

11:	9.6	→
12:	9.9	→
13:	9.6	→
14:	9.8	→
15:	9.5	→
16:	9.6	↑
17:	9.9	↑
18:	9.5	↘
19:	10.3	↗
20:	10.0	↘
Serie		92 ( 0x)
Total		191 ( 5x)

Hold <b>22</b>	Skive <b>5</b>	<b>Martin Schou-Friis</b>		
50m		Dauglykke Skytteforening		MST3
09.08.2025		EM 2025		Hanebjerg Skyttecenter
Kommentar		Signatur		

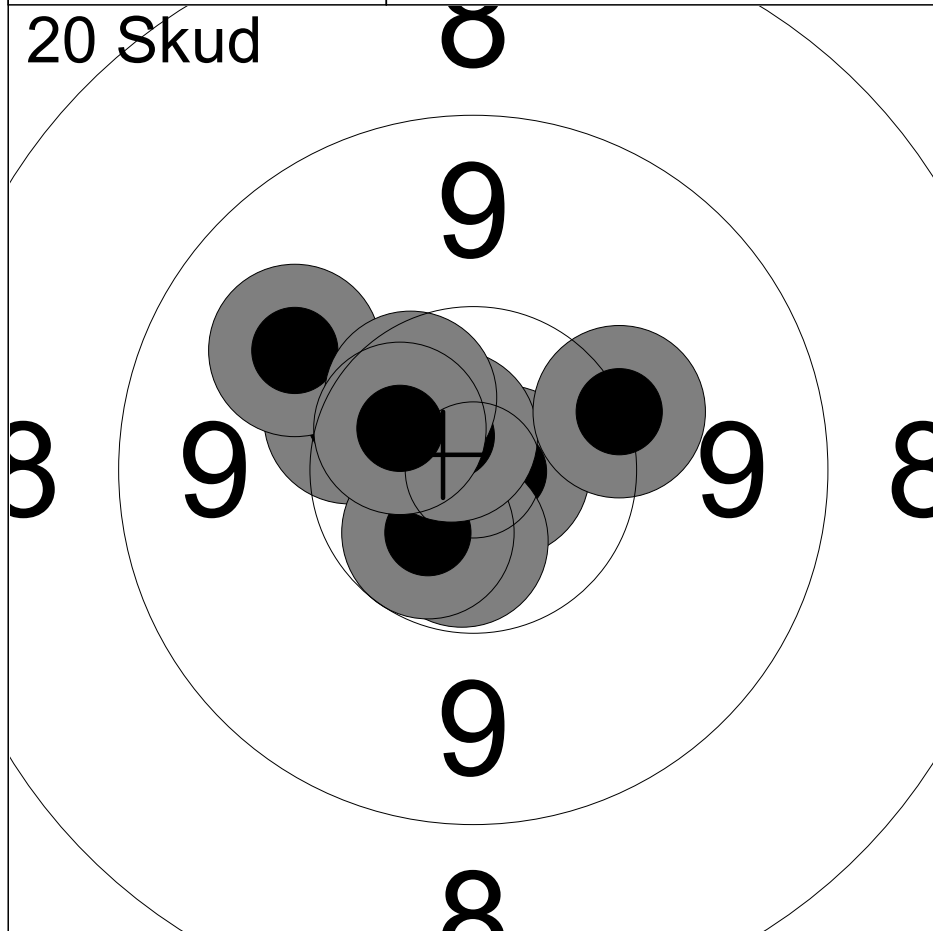

1:	10.3	↖
2:	9.9	↗
3:	10.8x	→
4:	10.6x	↘
5:	10.6x	↗
6:	10.6x	↖
7:	10.8x	↗
8:	10.5x	↗
9:	10.2	↗
10:	10.5x	↖
Serie		99 ( 7x)
Total		99 ( 7x)

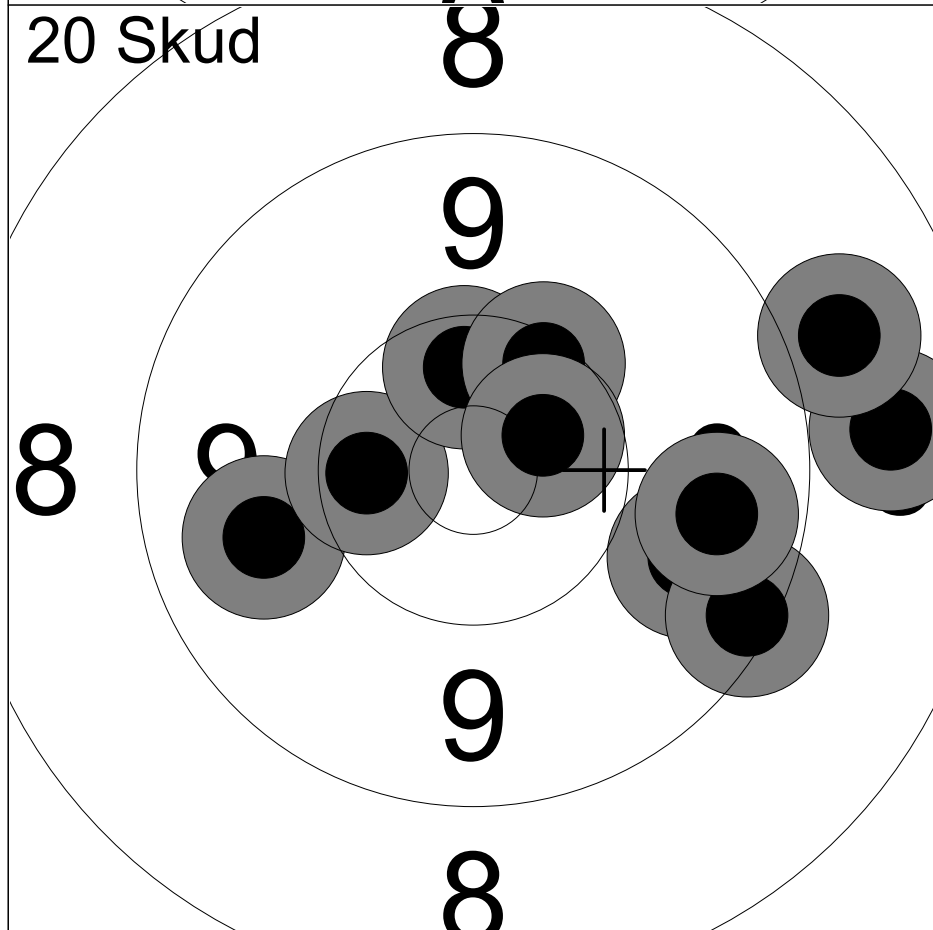

11:	9.7	→
12:	9.8	←
13:	10.4	←
14:	10.4x	↑
15:	10.3	↗
16:	10.6x	↗
17:	8.7	→
18:	9.3	↘
19:	9.7	→
20:	8.9	↗
Serie		92 ( 2x)
Total		191 ( 9x)

Hold <b>22</b>	Skive <b>7</b>	<b>Michael Pedersen</b>		
50m		Frederikssund Skytteforening, I	MSE2	
09.08.2025		EM 2025	Hanebjerg Skyttecenter	
Kommentar		Signatur		

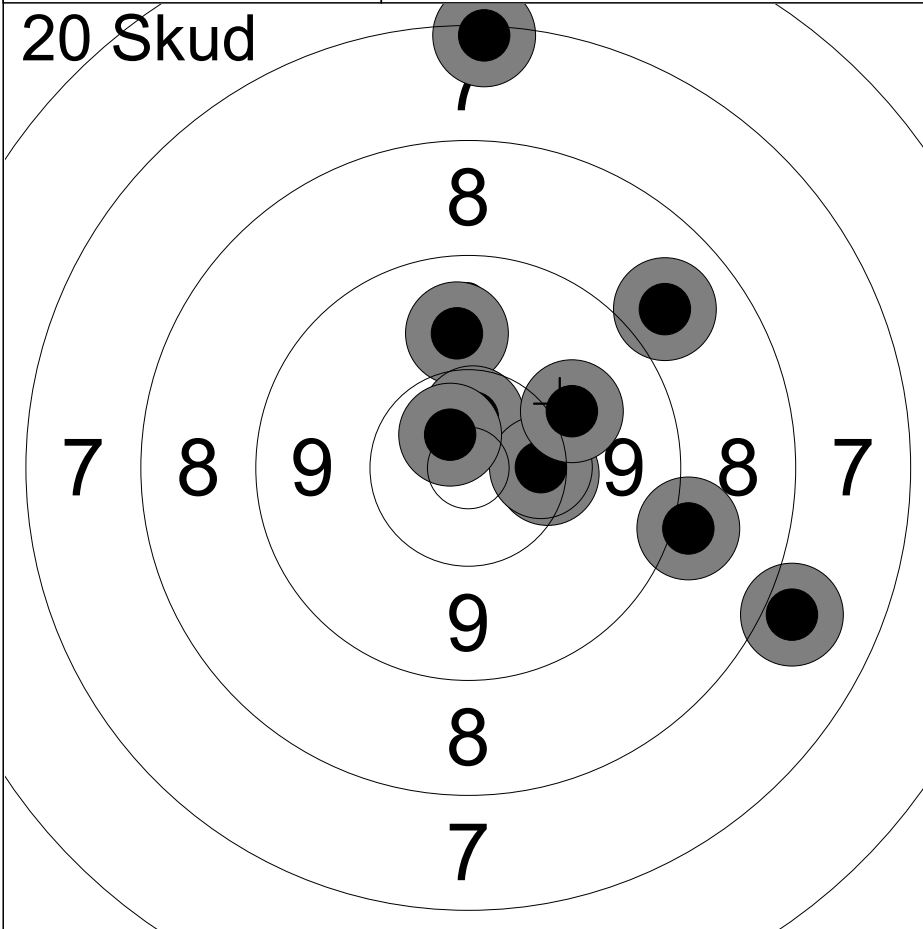

1:	7.3	↑
2:	7.9	→
3:	8.8	↗
4:	9.9	↑
5:	10.3	→
6:	9.0	→
7:	10.5x	↑
8:	10.4	→
9:	10.6x	↖
10:	10.0	↗

Serie	90 ( 2x)
Total	90 ( 2x)

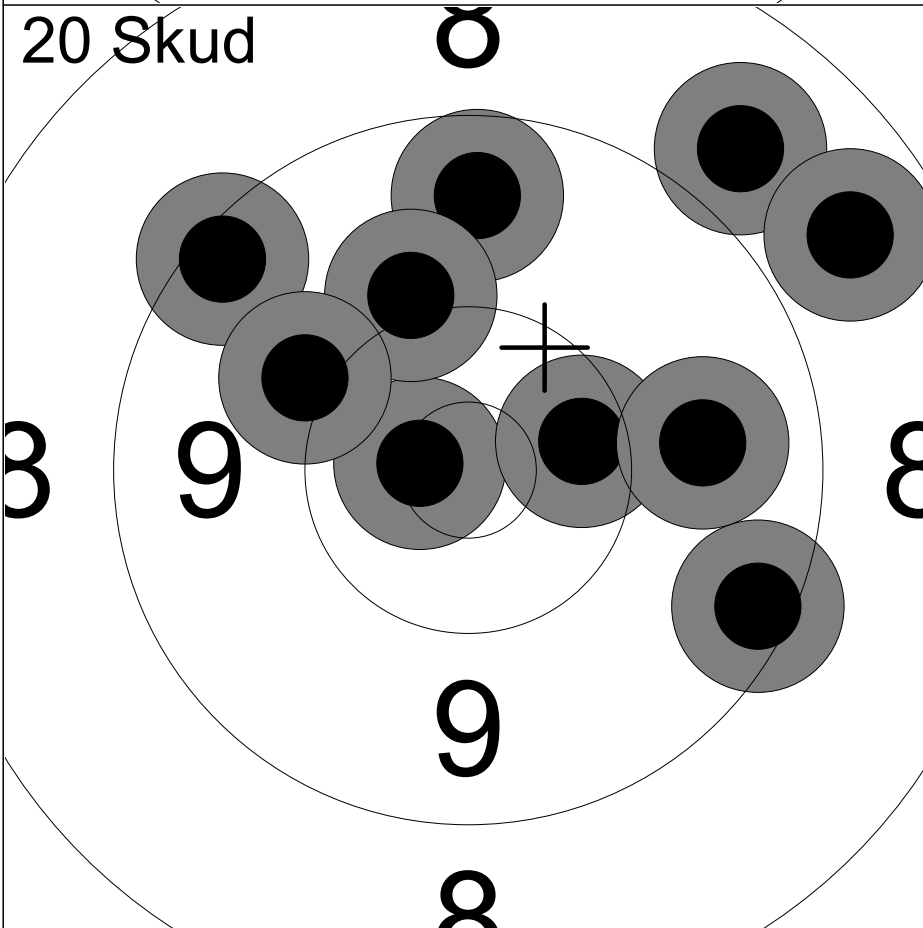

11:	9.4	→
12:	10.7x	←
13:	9.3	↗
14:	9.6	↑
15:	10.4	→
16:	10.1	↑
17:	8.8	↗
18:	9.8	→
19:	10.0	↖
20:	8.7	↗

Serie	92 ( 1x)
Total	182 ( 3x)

Hold <b>22</b>	Skive <b>8</b>	<b>Jacob Frederiksen</b>	
50m	Frederikssund Skytteforening, I	MÅ2	
09.08.2025	EM 2025	Hanebjerg Skyttecenter	
Kommentar	Signatur		

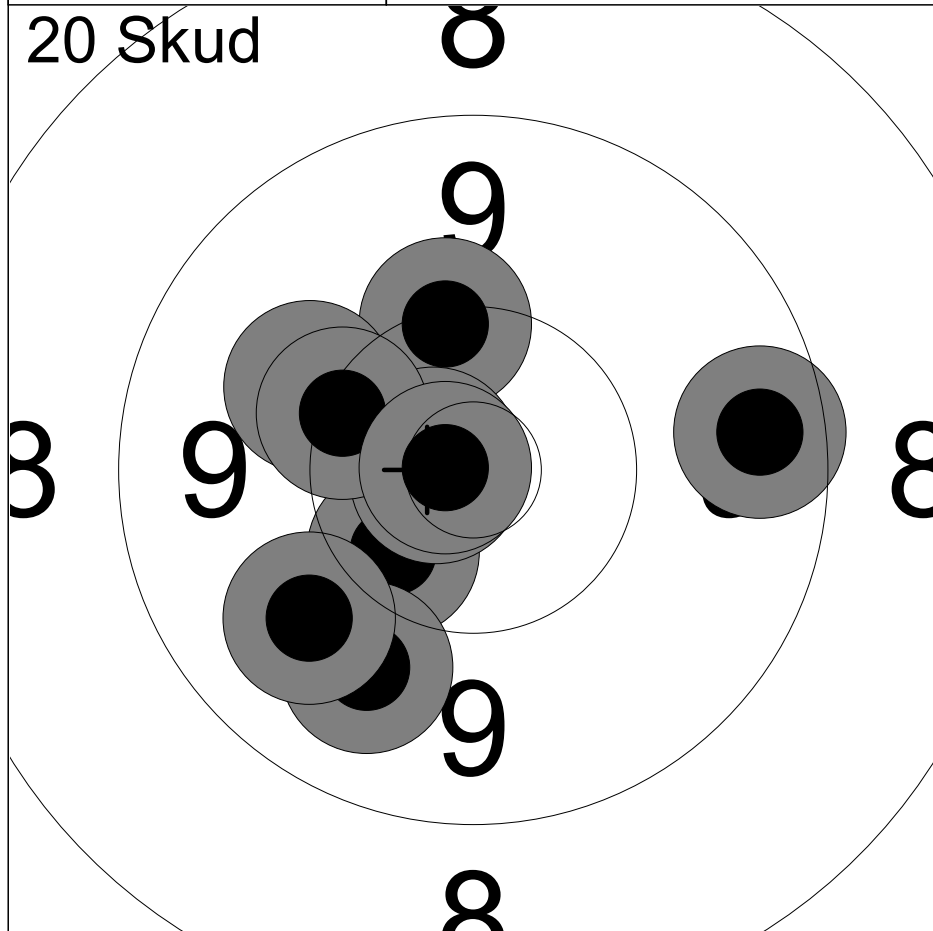

1:	10.4	↙
2:	9.5	→
3:	10.2	↑
4:	10.7x	↖
5:	10.1	↖
6:	10.8x	←
7:	10.3	↖
8:	9.9	↘
9:	9.9	↘
10:	10.8x	←
Serie		97 ( 3x)
Total		97 ( 3x)

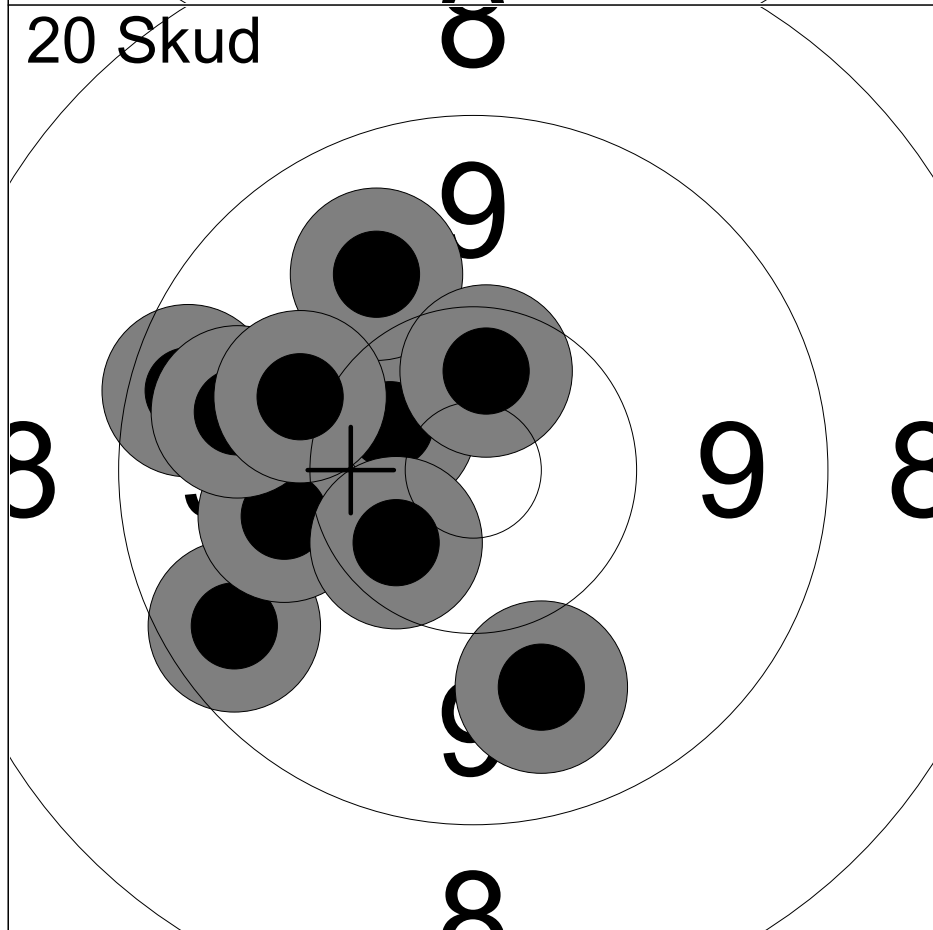

11:	10.5x	↖
12:	9.5	↖
13:	10.0	←
14:	10.4x	↖
15:	9.8	↘
16:	9.5	←
17:	9.9	↗
18:	10.5x	↑
19:	9.8	←
20:	10.0	↖
Serie		95 ( 3x)
Total		192 ( 6x)

Hold <b>22</b>	Skive <b>9</b>	<b>Erik Nissen</b>		
50m	Frederikssund Skytteforening, I		MBK1	
09.08.2025	EM 2025	Hanebjerg Skyttecenter		
Kommentar	Signatur			

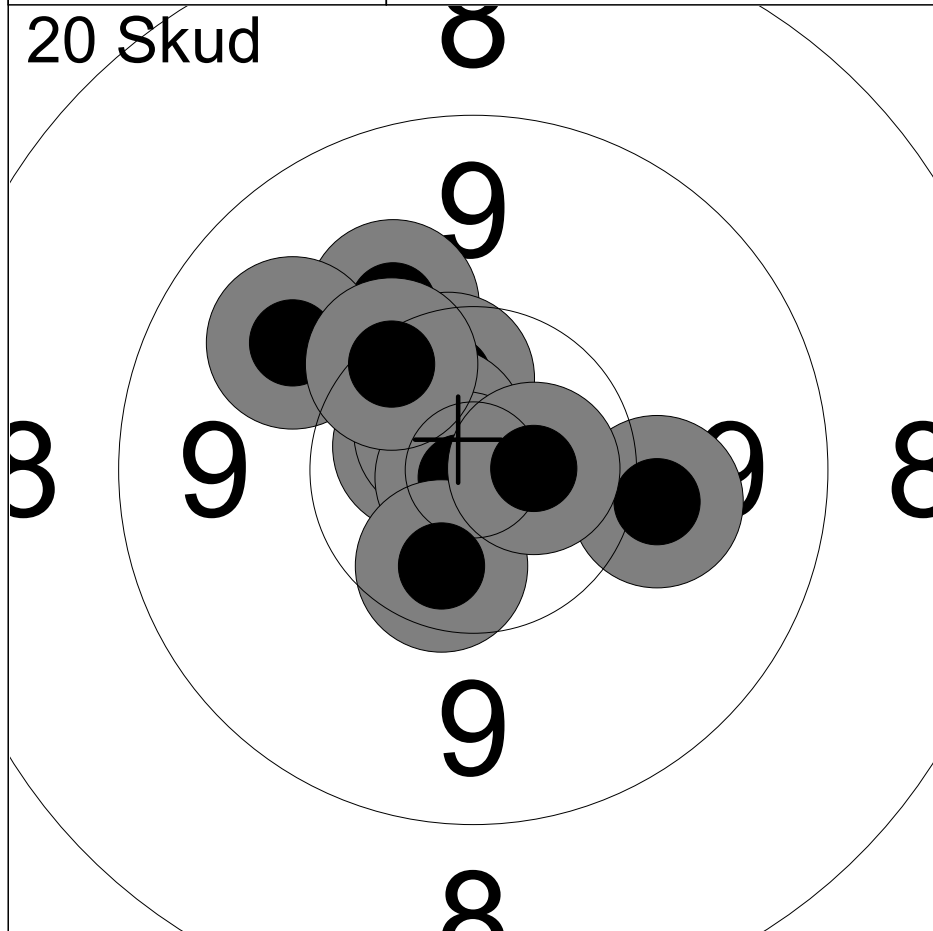

1:	10.1	↗
2:	10.5x	↗
3:	10.7x	↗
4:	9.9	↗
5:	10.7x	↗
6:	10.9x	↖
7:	10.3	↗
8:	10.0	→
9:	10.5x	↘
10:	10.7x	→
Serie		99 ( 6x)
Total		99 ( 6x)

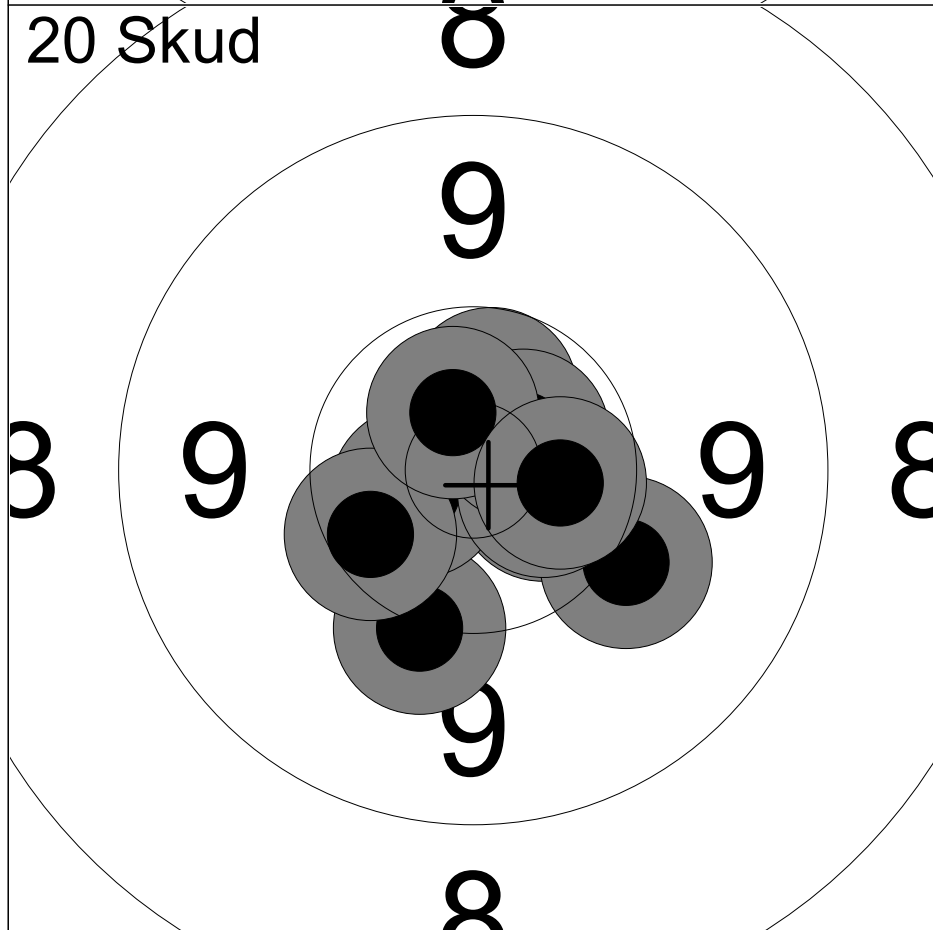

11:	10.6x	→
12:	10.1	↘
13:	10.7x	↖
14:	10.4	↖
15:	10.6x	↗
16:	10.1	↘
17:	10.6x	→
18:	10.7x	↗
19:	10.7x	↗
20:	10.5x	→
Serie		100 ( 7x)
Total		199 (13x)

Hold <b>22</b>	Skive <b>10</b>	<b>Mathilde Maj Schou-Friis</b>	
50m		Frederikssund Skytteforening, I	MBK1
09.08.2025		EM 2025	Hanebjerg Skyttecenter
Kommentar		Signatur	

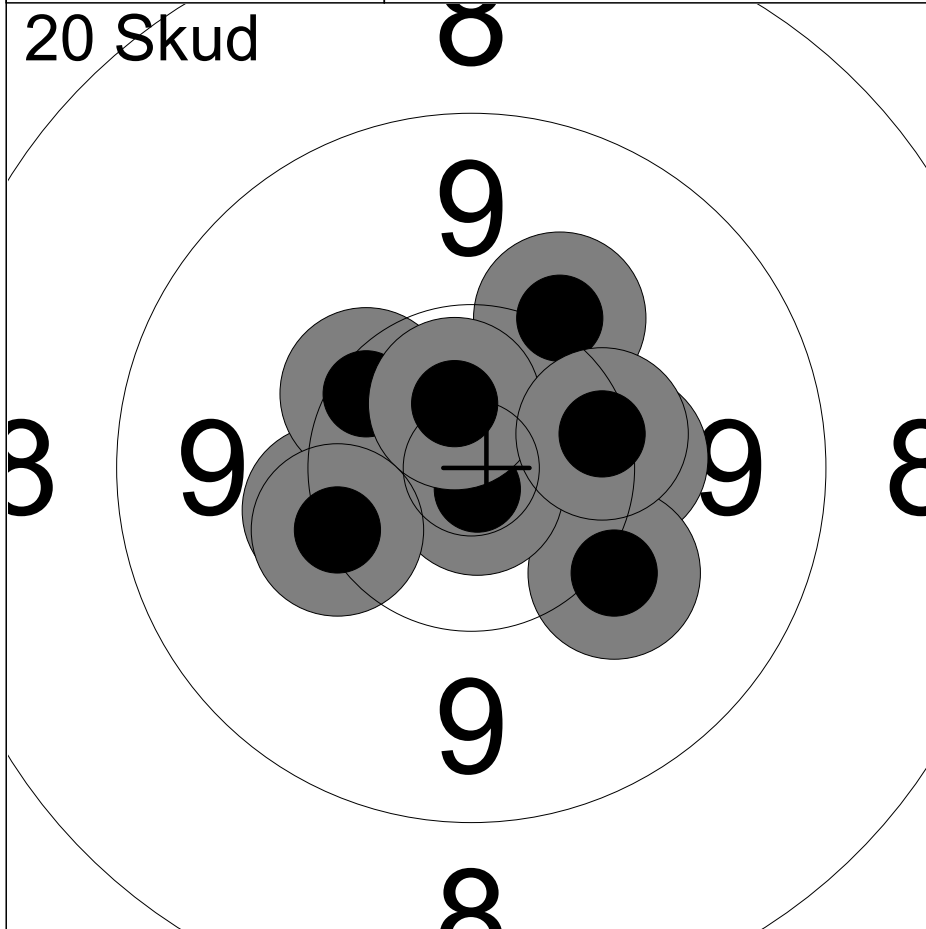

1:	10.4x	→
2:	10.2	←
3:	10.2	→
4:	10.1	↘
5:	10.1	↗
6:	10.3	↖
7:	10.8x	↙
8:	10.6x	↑
9:	10.2	←
10:	10.3	→
Serie		100 ( 3x)
Total		100 ( 3x)

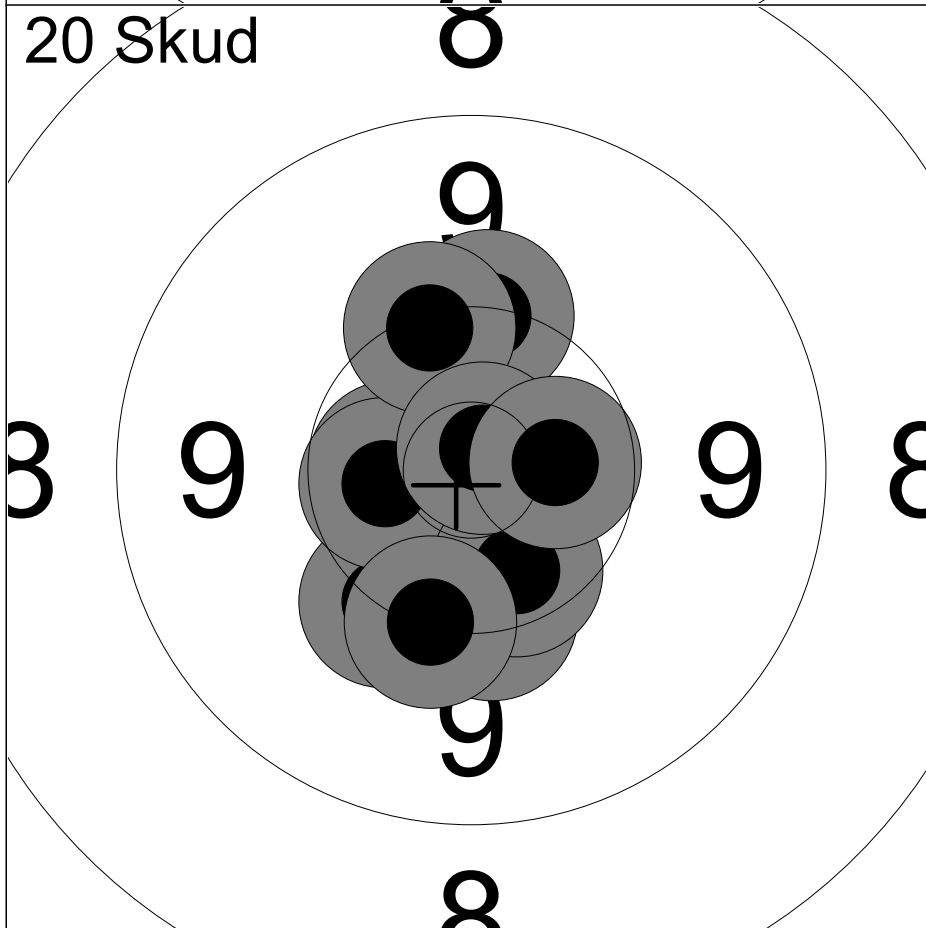

11:	10.2	↙
12:	10.6x	←
13:	10.5x	←
14:	10.2	↘
15:	10.4x	↘
16:	10.2	↑
17:	10.2	↙
18:	10.2	↑
19:	10.8x	↗
20:	10.5x	→
Serie		100 ( 5x)
Total		200 ( 8x)

Hold <b>22</b>	Skive <b>11</b>	<b>Sigurd Rasmussen</b>	
50m	Frederikssund Skytteforening, I	MBK2	
09.08.2025	EM 2025	Hanebjerg Skyttecenter	
Kommentar	Signatur		

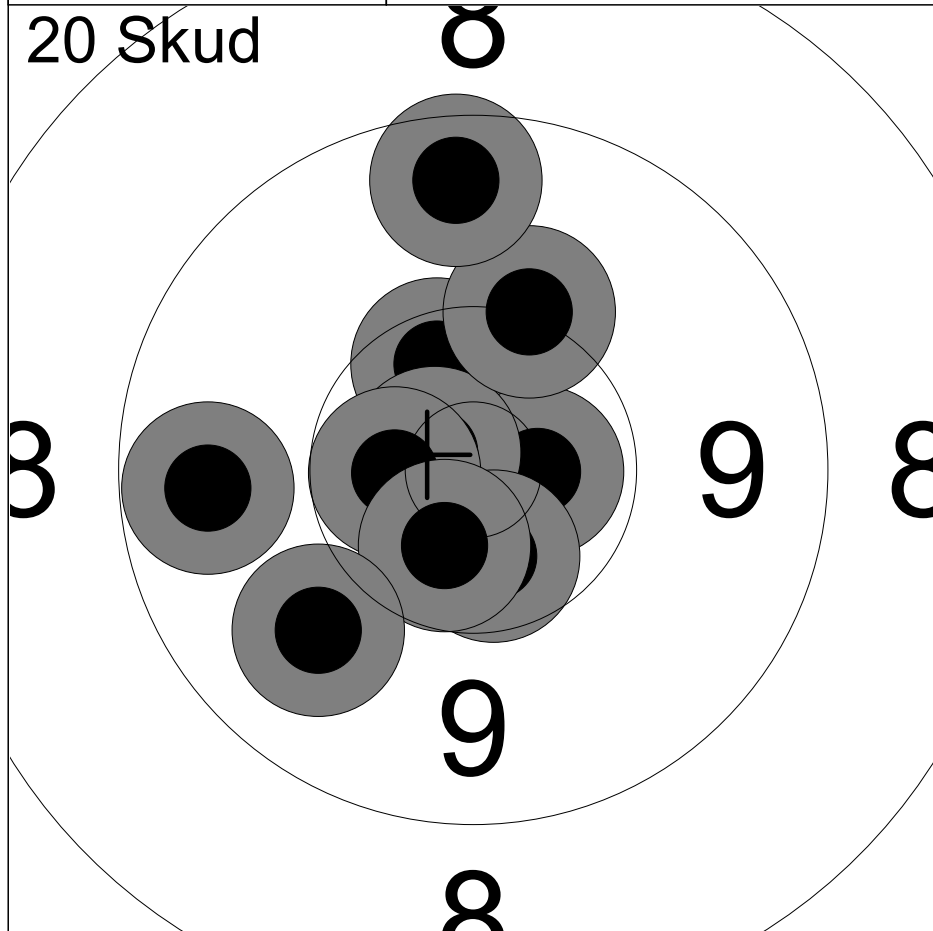

1:	10.4	↗
2:	10.6x	→
3:	9.6	←
4:	10.7x	↖
5:	10.1	↗
6:	10.6x	←
7:	9.5	↑
8:	10.5x	↓
9:	10.6x	↘
10:	9.9	↙
Serie		97 ( 5x)
Total		97 ( 5x)

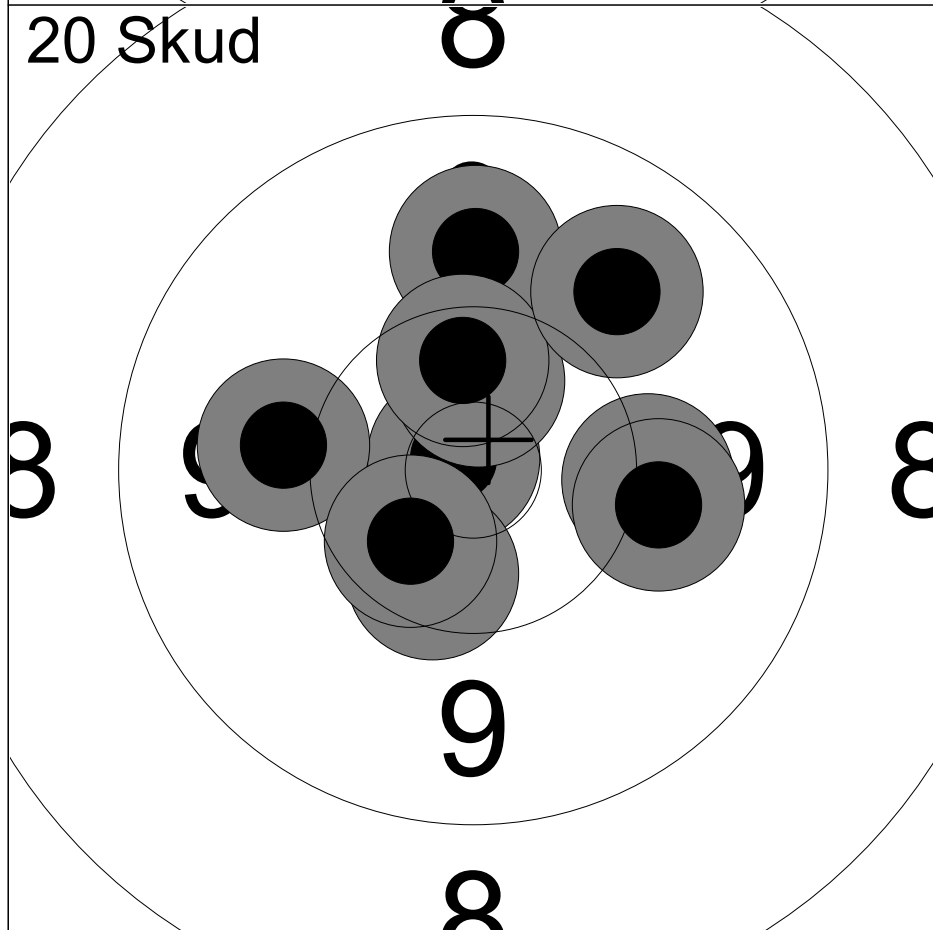

11:	10.8x	↖
12:	10.0	←
13:	10.5x	↑
14:	10.4	↘
15:	9.9	↑
16:	10.1	→
17:	10.4x	↑
18:	10.0	→
19:	9.8	↗
20:	10.5x	↙
Serie		98 ( 4x)
Total		195 ( 9x)

Hold <b>22</b>	Skive <b>12</b>	<b>Charlie Alexander Mouritsen</b>	
50m	Frederikssund Skytteforening, I	MJ2	
09.08.2025	EM 2025	Hanebjerg Skyttecenter	
Kommentar	Signatur		

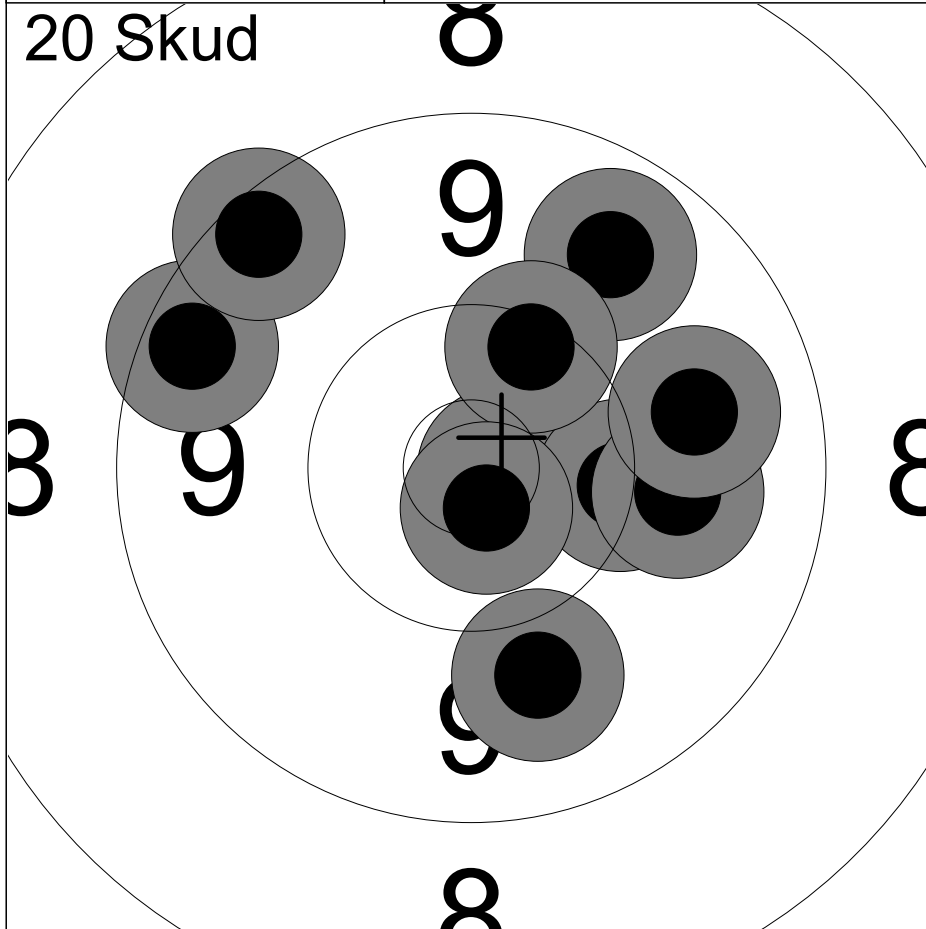

1:	9.7	↗
2:	10.8x	→
3:	10.2	→
4:	9.9	→
5:	10.3	↗
6:	9.8	→
7:	9.9	↘
8:	10.7x	↘
9:	9.4	↗
10:	9.4	↗
Serie		94 ( 2x)
Total		94 ( 2x)

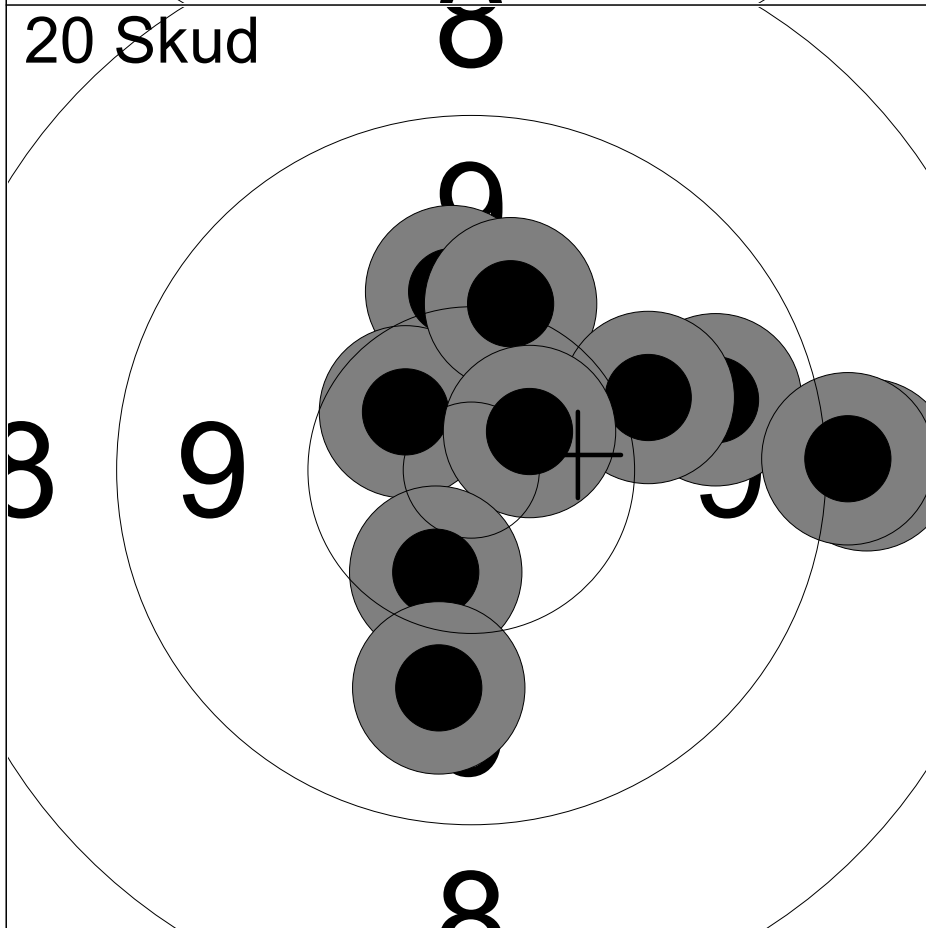

11:	10.1	↑
12:	10.5x	↗
13:	9.7	→
14:	9.0	→
15:	10.1	↑
16:	10.0	→
17:	10.6x	↗
18:	9.1	→
19:	10.4x	↘
20:	9.9	↘
Serie		96 ( 3x)
Total		190 ( 5x)

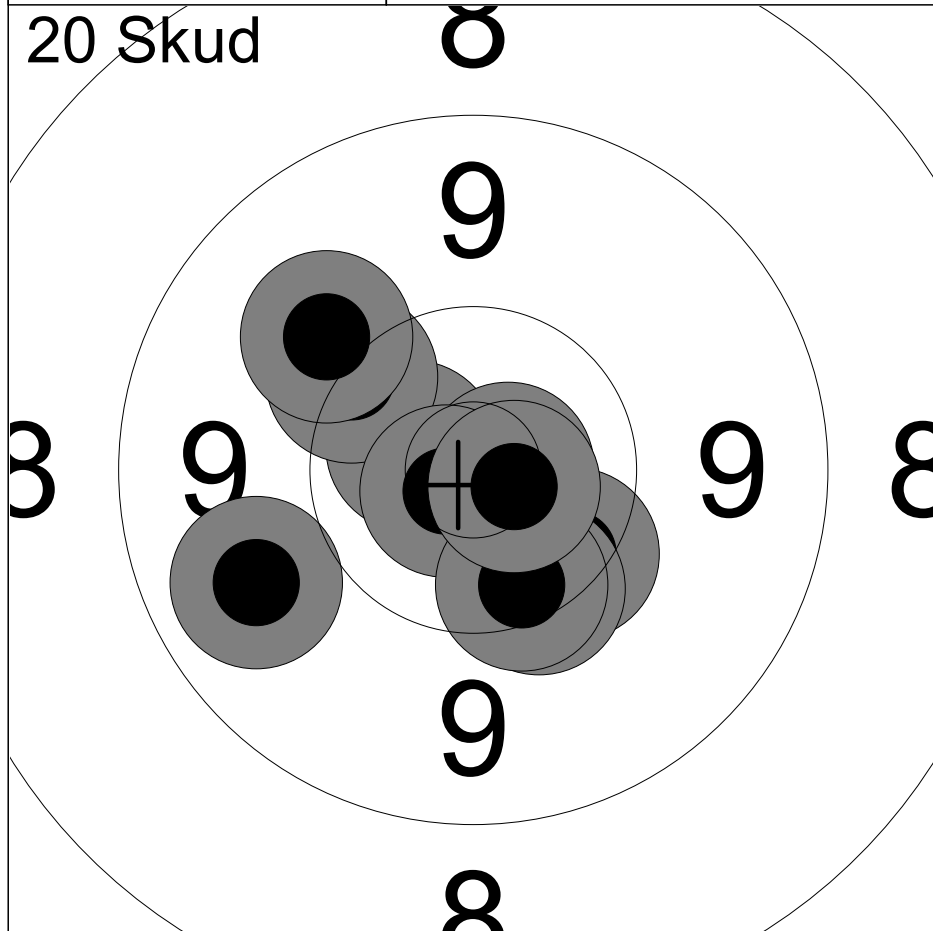

1:	10.6x	↖
2:	10.3	↘
3:	10.3	↘
4:	10.8x	→
5:	10.2	↗
6:	10.8x	↖
7:	10.3	↘
8:	9.7	↖
9:	10.7x	↘
10:	10.0	↗

Serie	99 ( 4x)
Total	99 ( 4x)

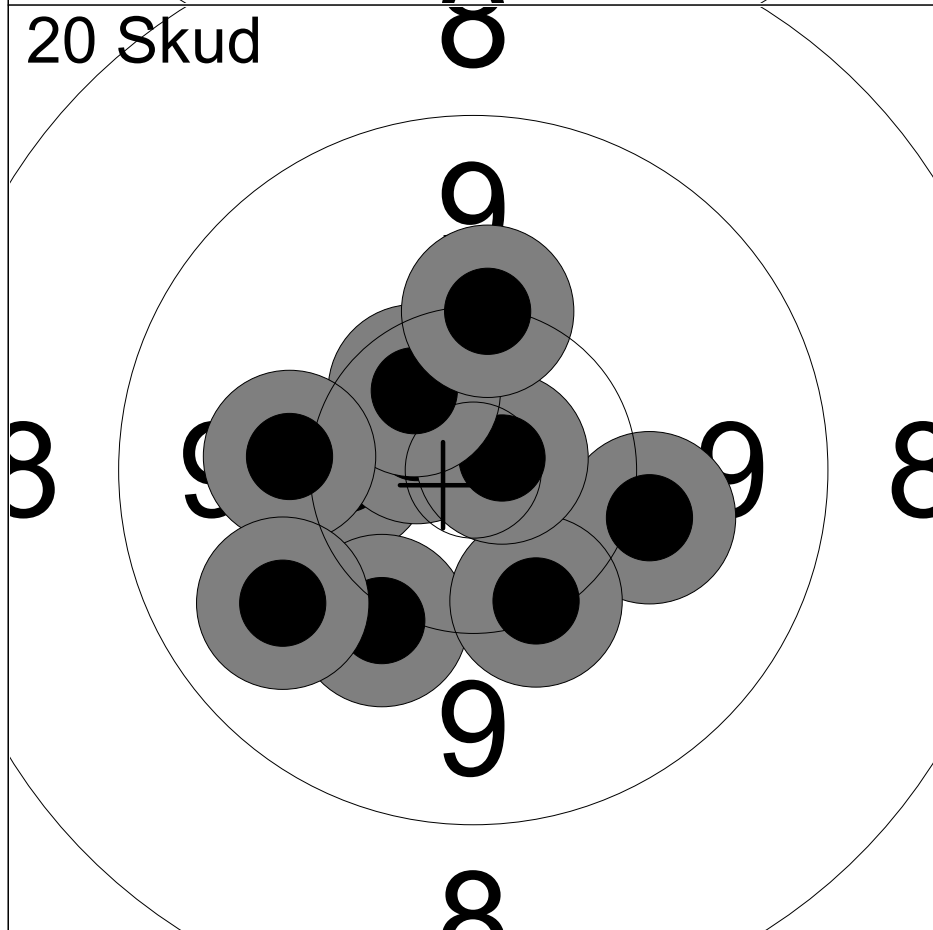

11:	10.3	←
12:	10.6x	↗
13:	10.1	↘
14:	10.1	→
15:	10.2	↘
16:	10.8x	↗
17:	10.5x	↗
18:	10.2	↑
19:	10.1	←
20:	9.8	↙

Serie	99 ( 3x)
Total	198 ( 7x)

Hold <b>23</b>	Skive <b>3</b>	<b>Viktor Lund-Vogensen</b>		
50m		Ganløse Skytteforening		MJ2
09.08.2025		EM 2025		Hanebjerg Skyttecenter
Kommentar		Signatur		

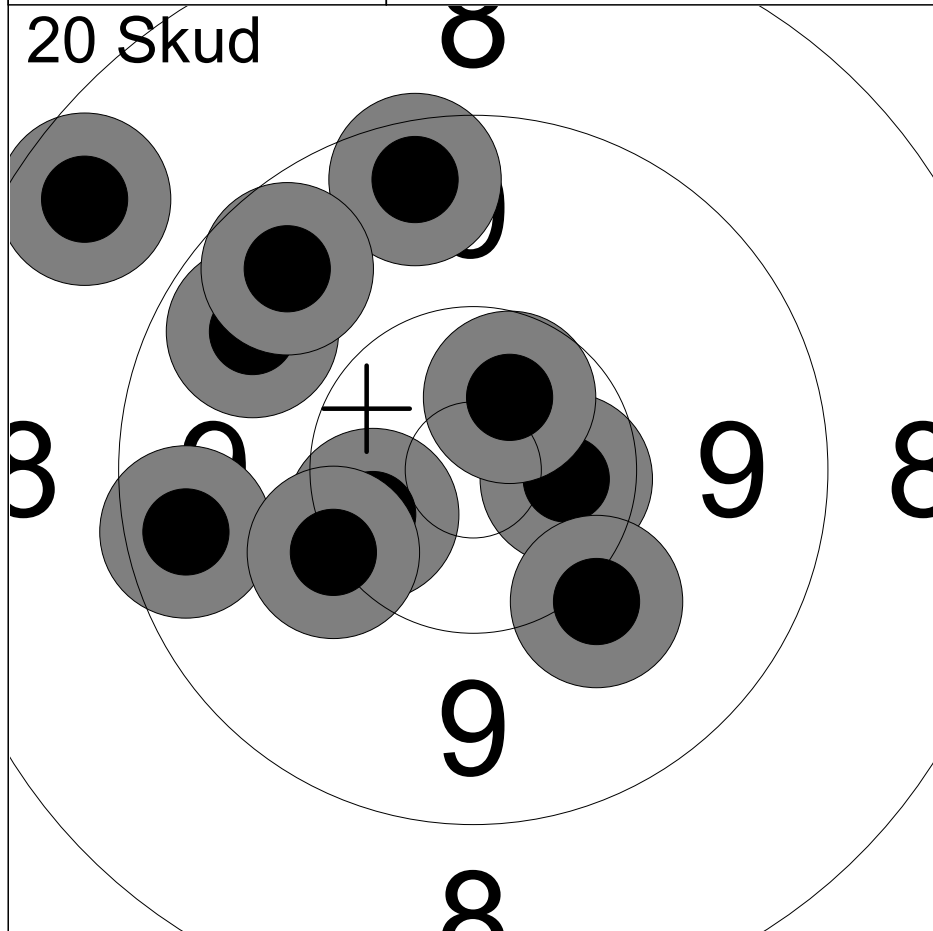

1:	10.4x	↙
2:	8.6	↗
3:	9.5	↖
4:	10.5x	→
5:	9.7	↗
6:	10.2	↖
7:	9.5	↗
8:	9.6	↗
9:	10.6x	↗
10:	10.1	↘
Serie		94 ( 3x)
Total		94 ( 3x)

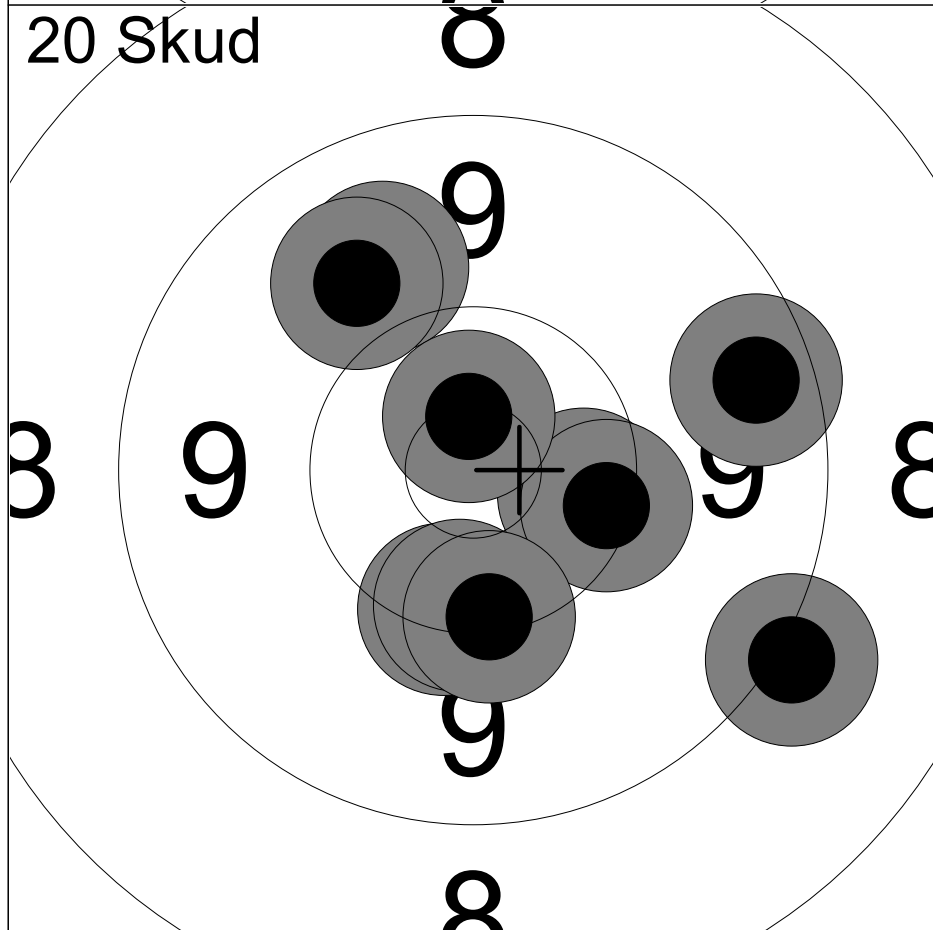

11:	10.3	↘
12:	9.9	↗
13:	9.9	↗
14:	10.4	→
15:	10.3	↘
16:	10.3	→
17:	10.2	↘
18:	10.7x	↗
19:	9.5	↗
20:	9.1	↘
Serie		96 ( 1x)
Total		190 ( 4x)

Hold <b>23</b>	Skive <b>4</b>	<b>Frederik Lund-Vogensen</b>	
50m		Ganløse Skytteforening	MJ2
09.08.2025		EM 2025	Hanebjerg Skyttecenter
Kommentar		Signatur	

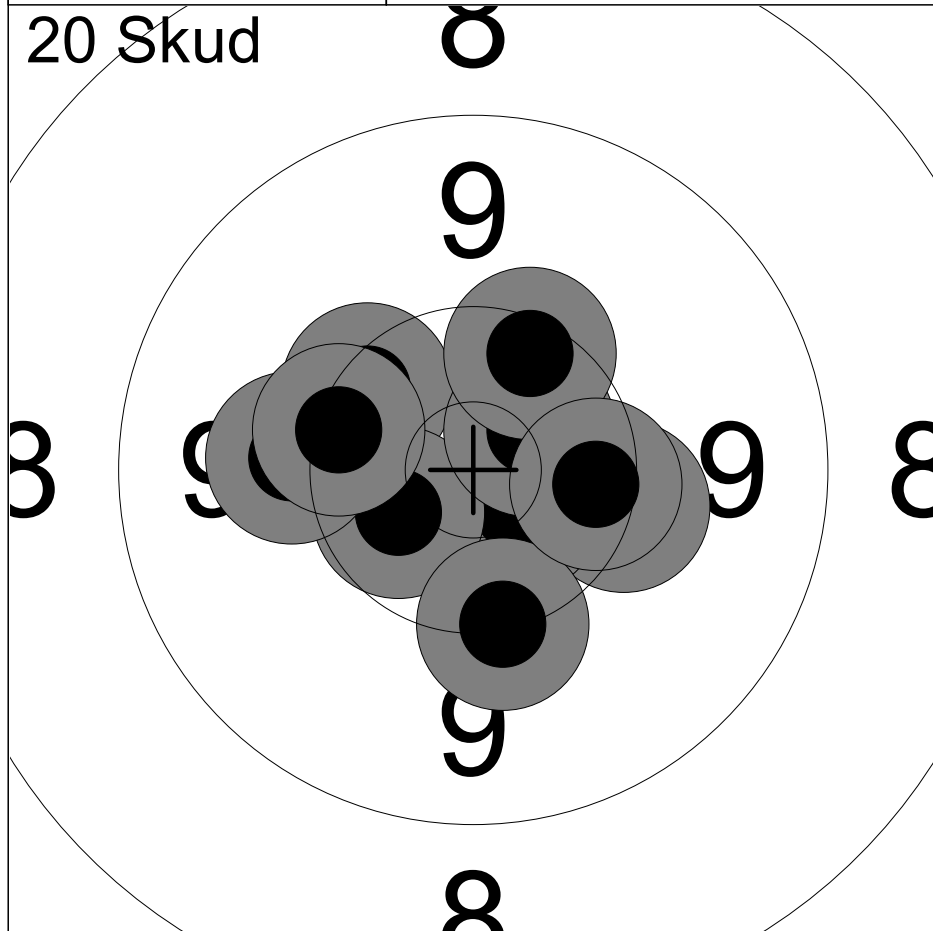

1:	10.2	→
2:	10.3	↗
3:	10.7x	↘
4:	10.5x	↖
5:	10.1	←
6:	10.3	↖
7:	10.2	↘
8:	10.6x	↗
9:	10.3	↗
10:	10.4	→
Serie		100 ( 3x)
Total		100 ( 3x)



11:	10.2	↑
12:	10.3	↗
13:	10.2	↗
14:	10.9x	↖
15:	10.5x	↗
16:	10.3	↗
17:	10.6x	↗
18:	10.5x	↗
19:	10.5x	↘
20:	10.7x	→
Serie		100 ( 6x)
Total		200 ( 9x)

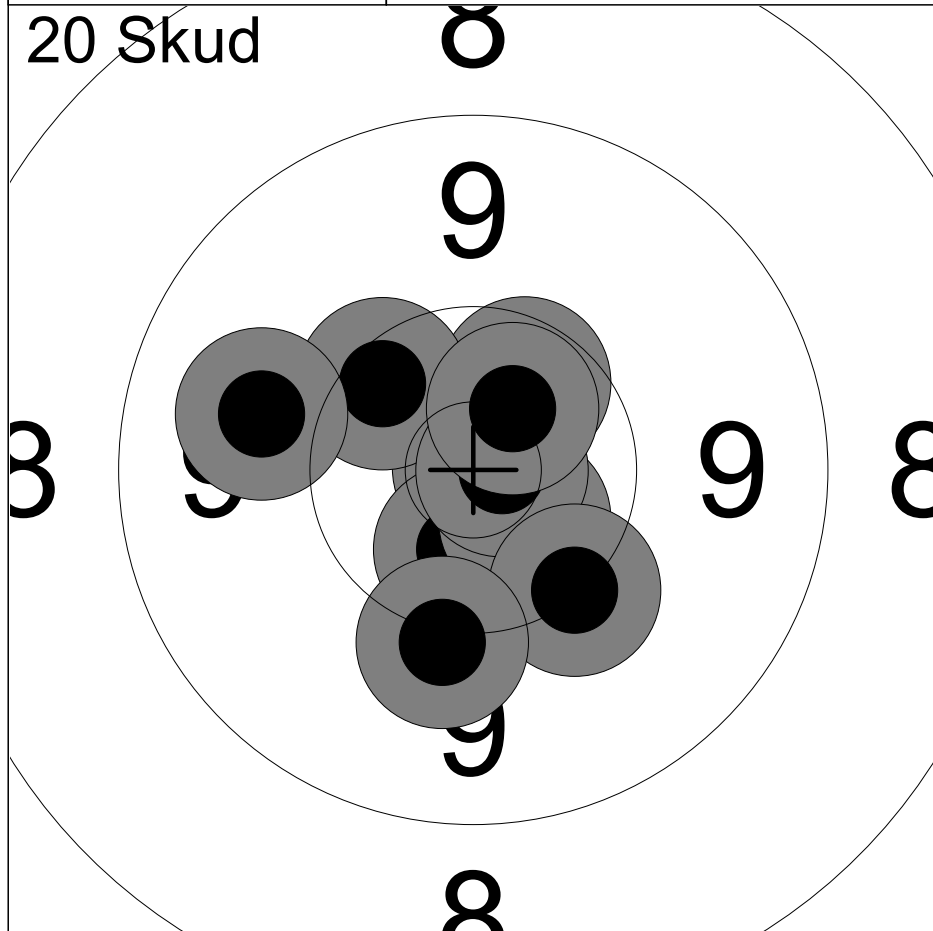

1:	10.5x	↗
2:	10.9x	↗
3:	10.6x	↘
4:	10.3	↗
5:	10.6x	↘
6:	9.9	↖
7:	10.8x	→
8:	10.6x	↗
9:	10.2	↘
10:	10.1	↘

Serie	99 ( 6x)
Total	99 ( 6x)

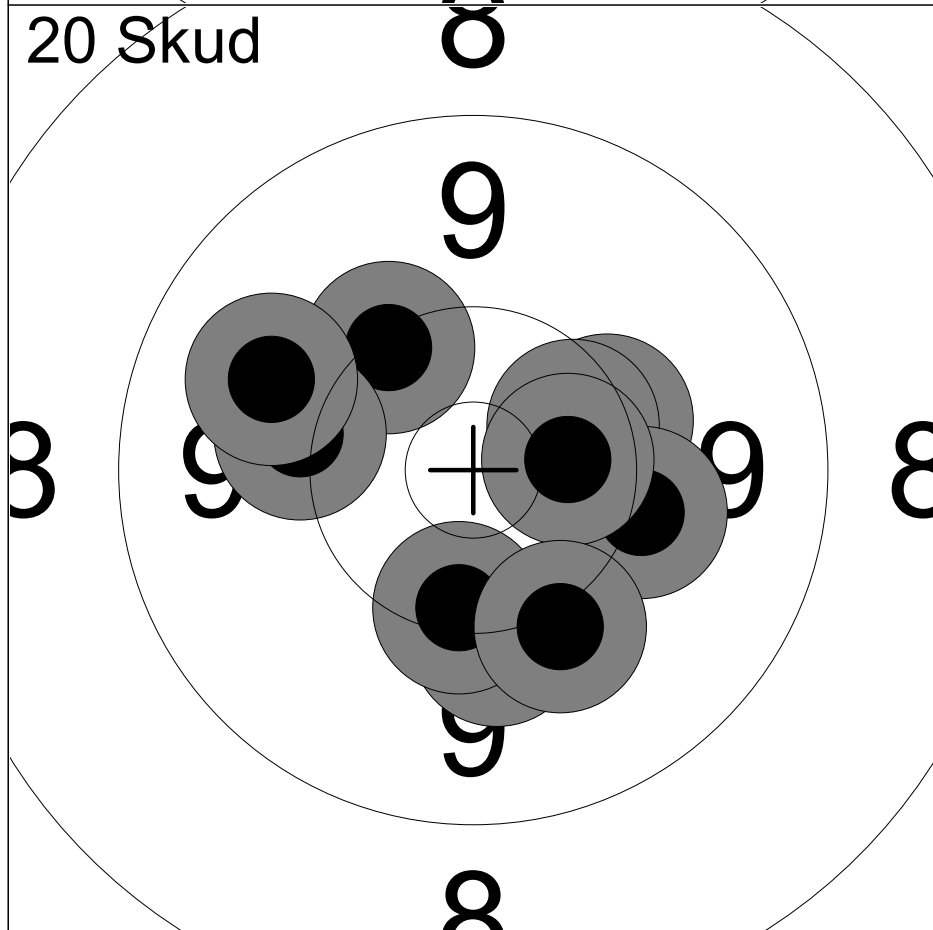

11:	10.3	↗
12:	10.2	↗
13:	10.4x	↗
14:	10.1	→
15:	10.1	↘
16:	10.1	↖
17:	10.5x	→
18:	9.9	↖
19:	10.3	↘
20:	10.1	↘

Serie	99 ( 2x)
Total	198 ( 8x)

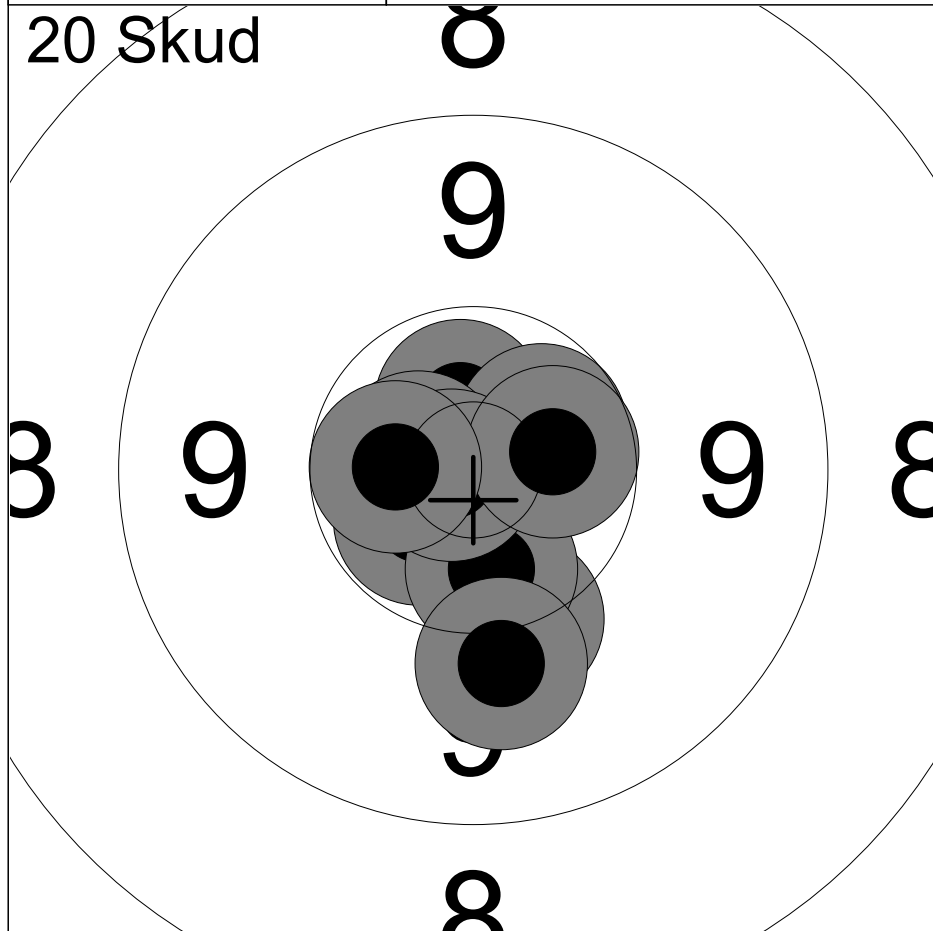

1:	10.6x	↑
2:	10.6x	↙
3:	10.2	↓
4:	10.6x	↗
5:	10.7x	↖
6:	10.5x	↓
7:	10.0	↓
8:	10.8x	↖
9:	10.6x	↗
10:	10.6x	↖

Serie	100 ( 8x)
Total	100 ( 8x)

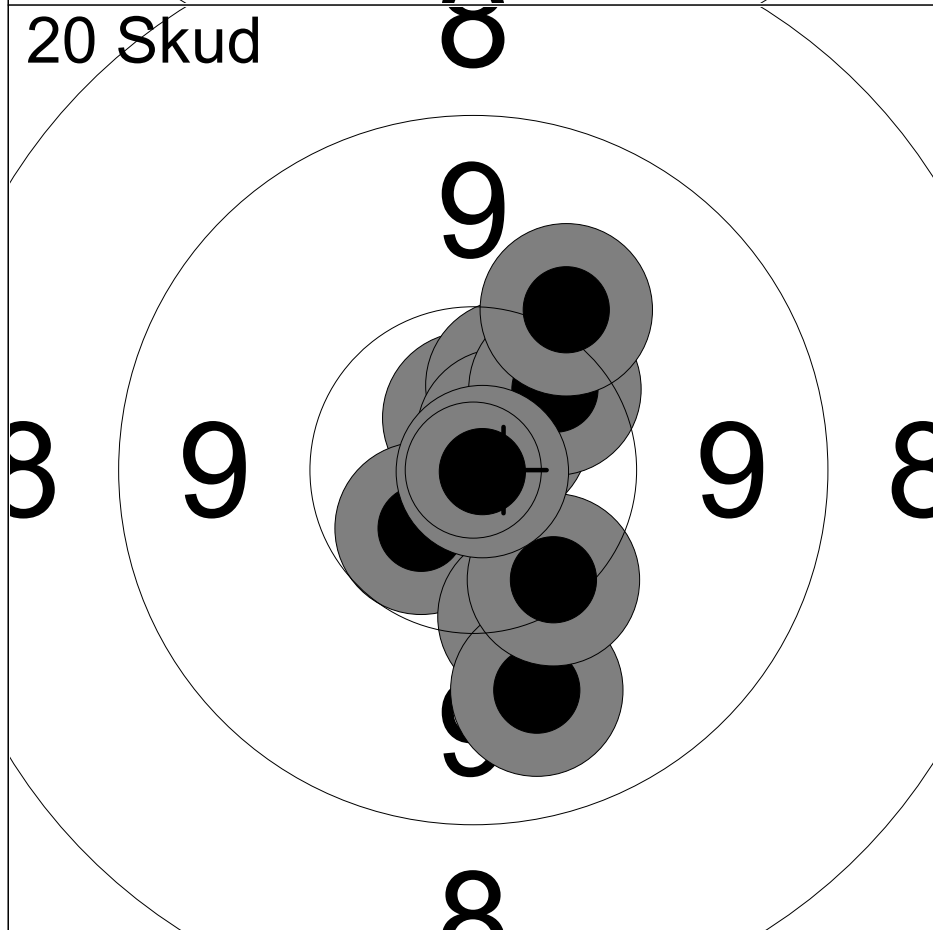

11:	10.7x	↑
12:	10.5x	↗
13:	10.7x	↗
14:	10.4	↗
15:	10.6x	↖
16:	10.2	↓
17:	9.8	↓
18:	10.3	↘
19:	10.9x	↗
20:	10.1	↗

Serie	99 ( 5x)
Total	199 (13x)

Hold <b>23</b>	Skive <b>10</b>	<b>Magnus Bjoernberg Levisen</b>	
50m	Ølstykke Skytteforening	MJ1	
09.08.2025	EM 2025	Hanebjerg Skyttecenter	
Kommentar	Signatur		

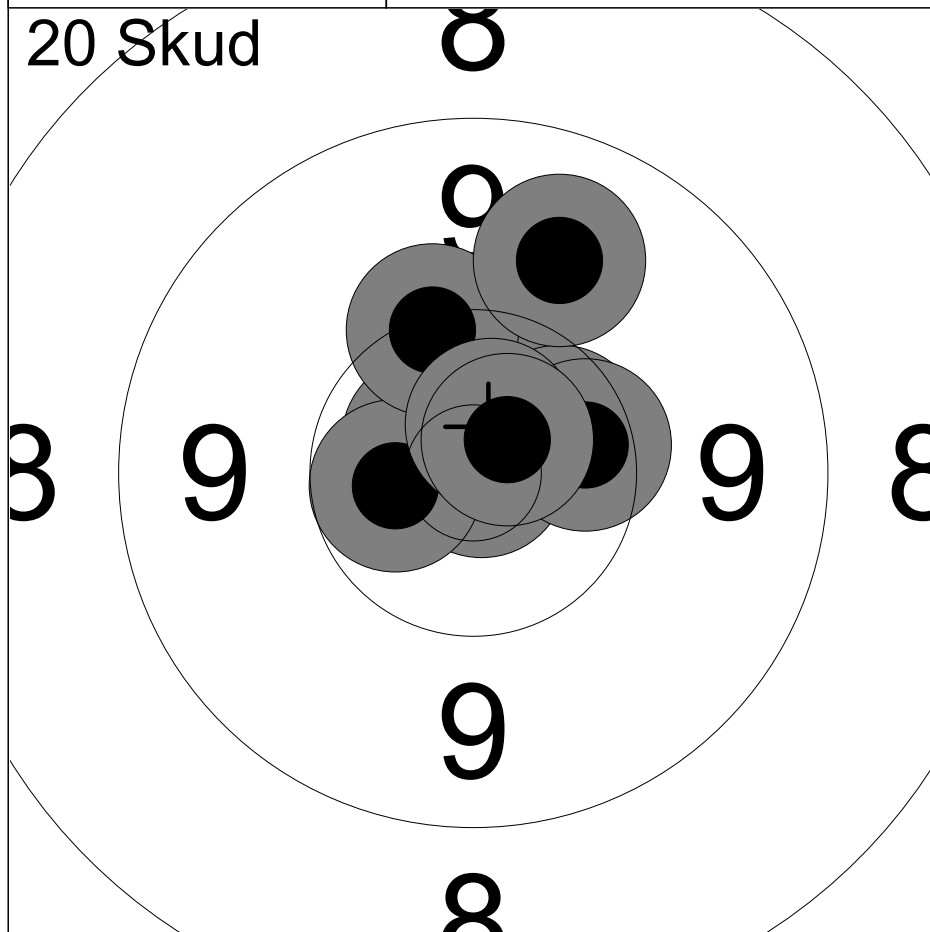

1:	10.9x	→
2:	10.6x	↗
3:	10.7x	↖
4:	10.5x	↗
5:	10.6x	←
6:	10.2	↗
7:	10.4	→
8:	10.7x	↗
9:	9.8	↗
10:	10.7x	↗
Serie		99 ( 7x)
Total		99 ( 7x)

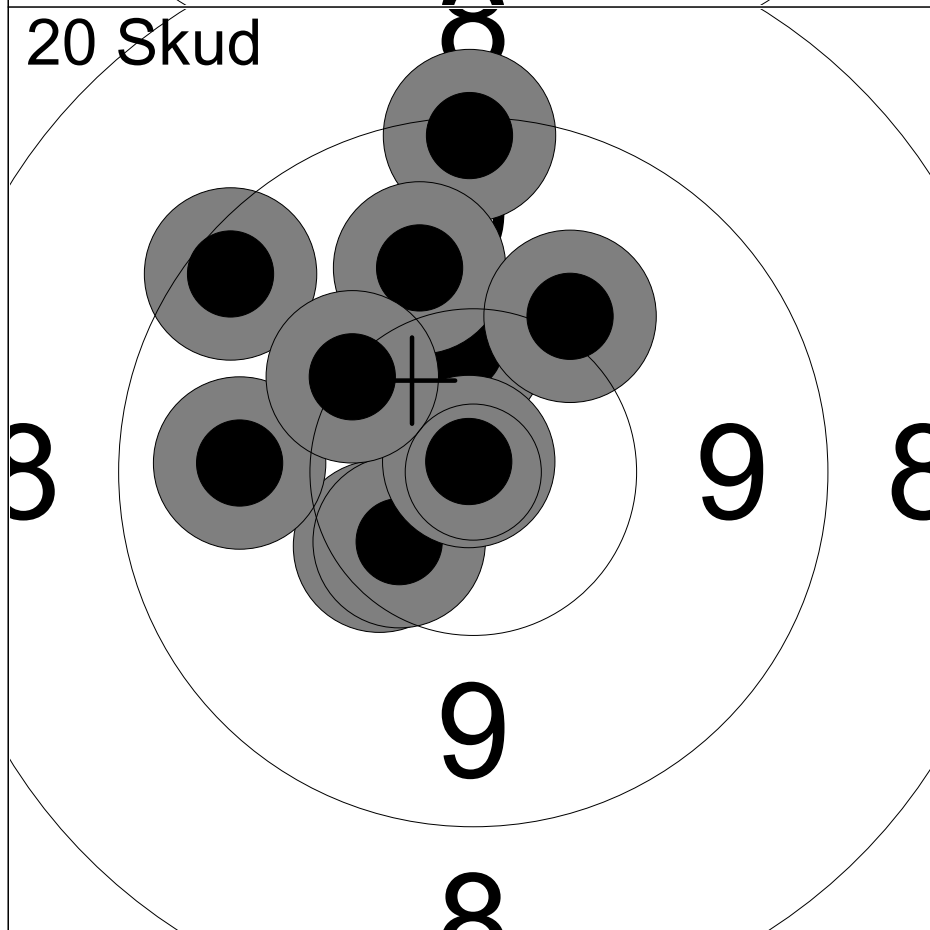

11:	10.4	↖
12:	10.5x	↖
13:	9.3	↑
14:	9.8	←
15:	9.4	↖
16:	10.3	↑
17:	10.9x	↗
18:	9.9	↑
19:	10.2	↖
20:	10.1	↗
Serie		96 ( 2x)
Total		195 ( 9x)

Hold <b>23</b>	Skive <b>11</b>	<b>Malou Schmidt-Larsen</b>	
50m		Ølstykke Skytteforening	MJ2
09.08.2025		EM 2025	Hanebjerg Skyttecenter
Kommentar		Signatur	

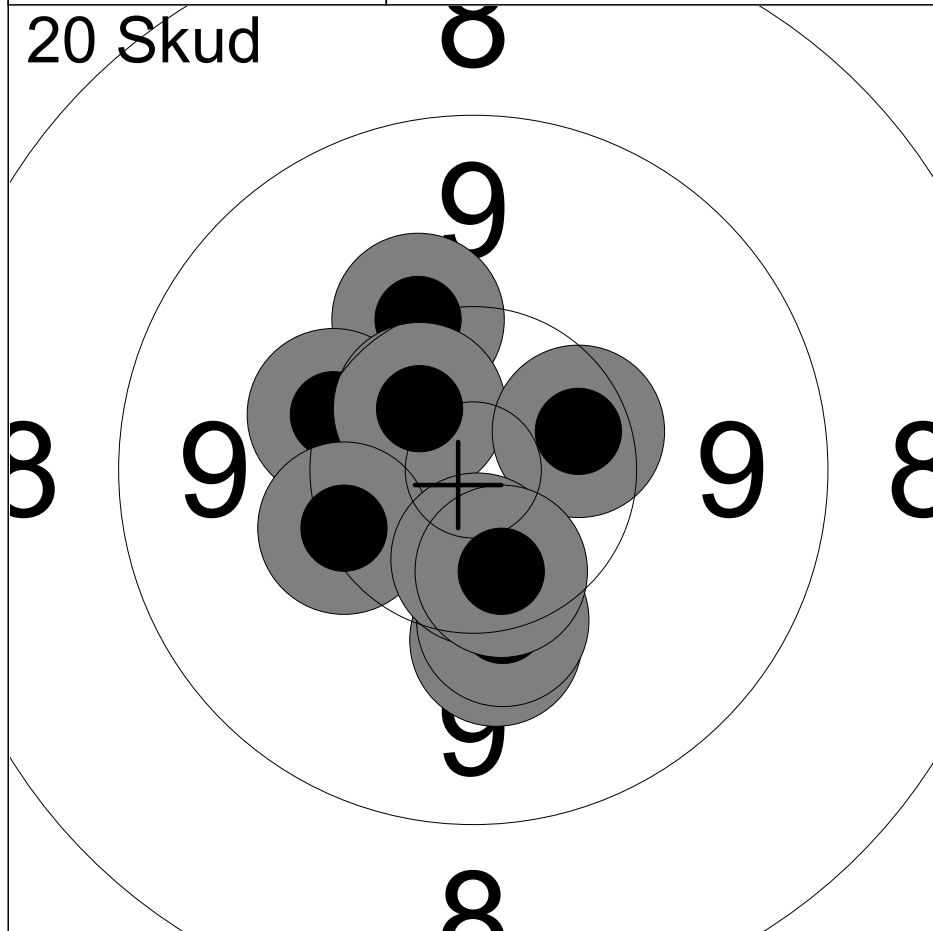

1:	10.4x	↖
2:	10.2	↗
3:	10.1	↘
4:	10.2	↖
5:	10.6x	↗
6:	10.3	↖
7:	10.2	↘
8:	10.4	↗
9:	10.5x	↘
10:	10.4x	↘
Serie		100 ( 4x)
Total		100 ( 4x)

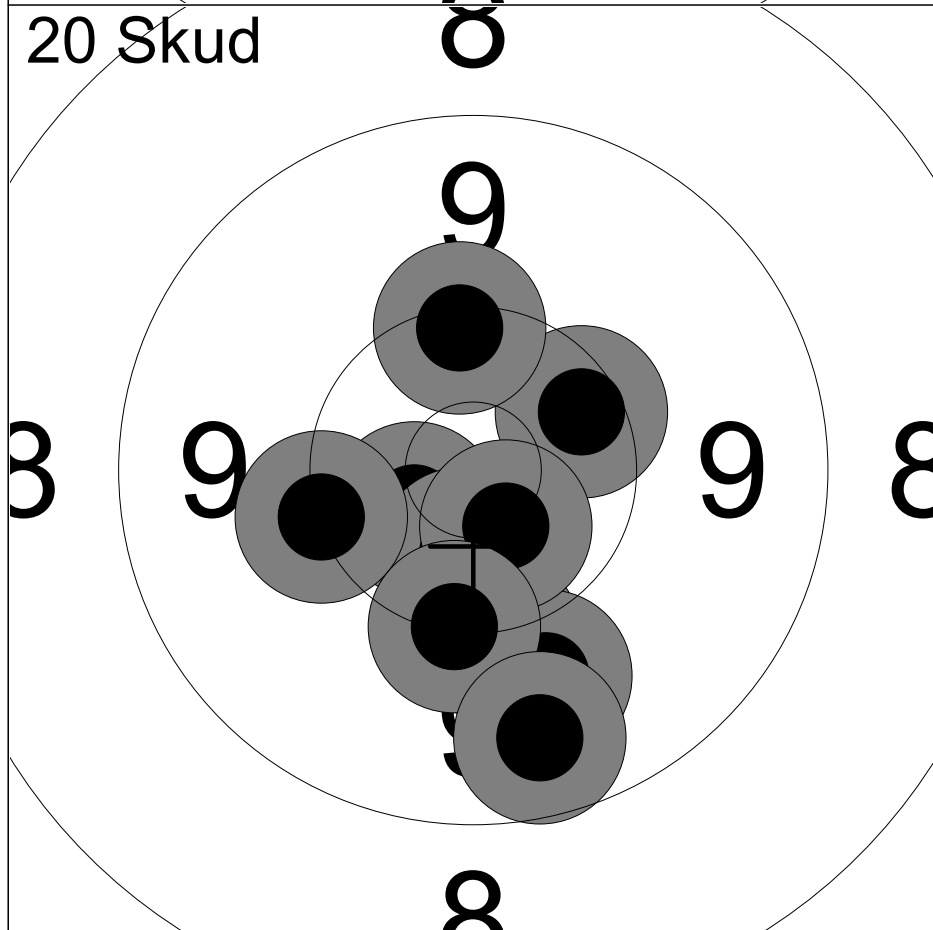

11:	10.6x	↖
12:	10.1	↘
13:	10.4	↗
14:	10.5x	↘
15:	9.9	↘
16:	10.6x	↘
17:	10.2	↖
18:	10.2	↘
19:	10.3	↗
20:	9.6	↘
Serie		98 ( 3x)
Total		198 ( 7x)



1:	10.5x	↑
2:	10.4x	↗
3:	10.2	↘
4:	9.9	↖
5:	10.5x	↑
6:	10.6x	→
7:	10.5x	↓
8:	10.2	↗
9:	10.6x	↗
10:	10.7x	↗

Serie	99 ( 7x)
Total	99 ( 7x)

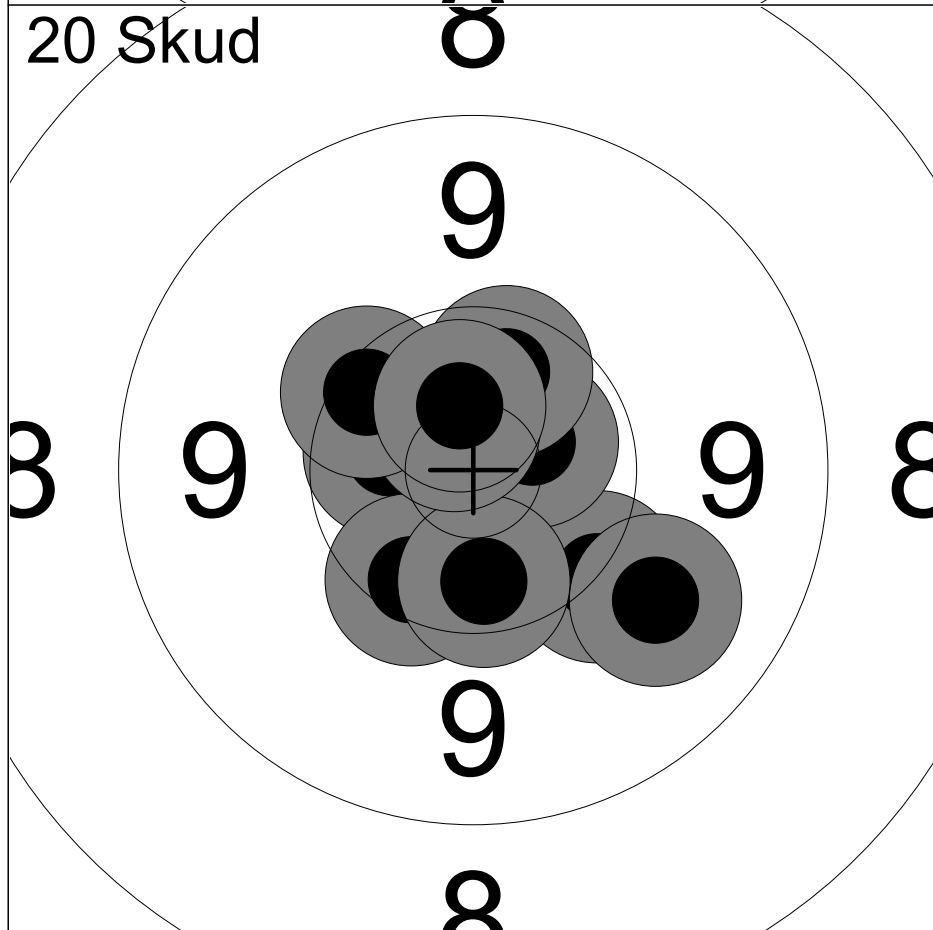

11:	10.2	↘
12:	9.9	↘
13:	10.5x	←
14:	10.3	↙
15:	10.6x	↗
16:	10.4	↓
17:	10.4x	↑
18:	10.7x	↗
19:	10.3	↖
20:	10.6x	↑

Serie	99 ( 5x)
Total	198 (12x)

Hold <b>24</b>	Skive <b>1</b>	<b>Amanda Jensen</b>		
50m		Kreds 57, Ferslev, Skibby		FJUN
10.08.2025		EM Finale 2025		Hanebjerg Skyttecenter
Kommentar		Signatur		

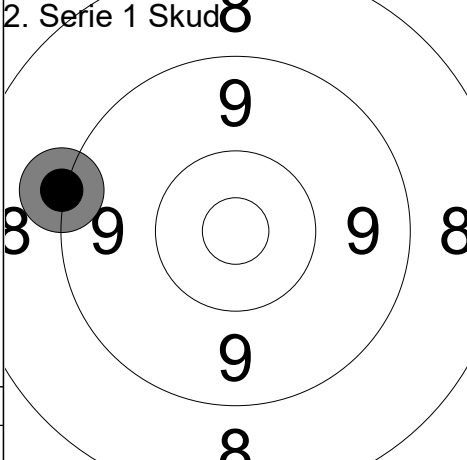
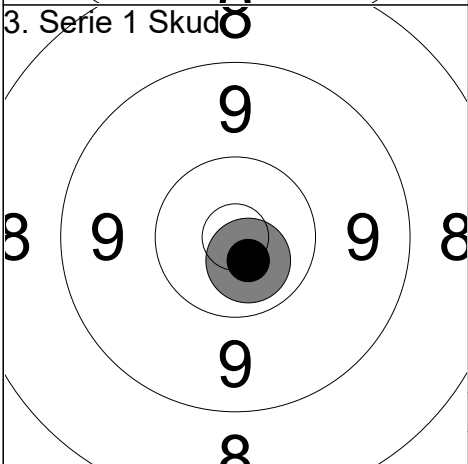
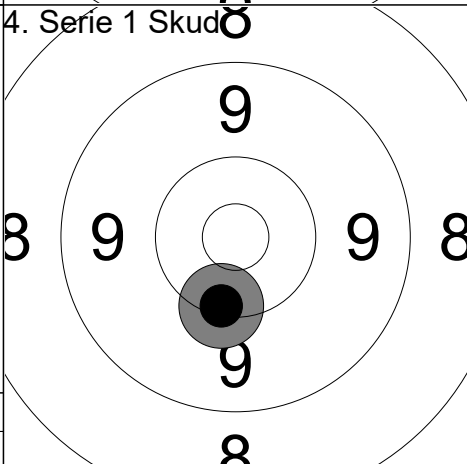
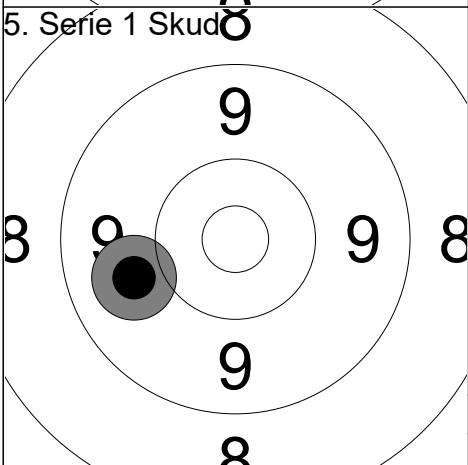
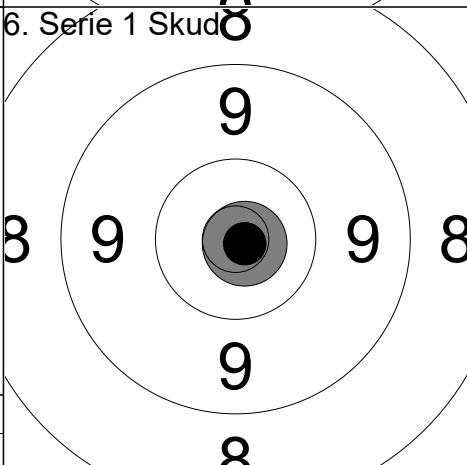
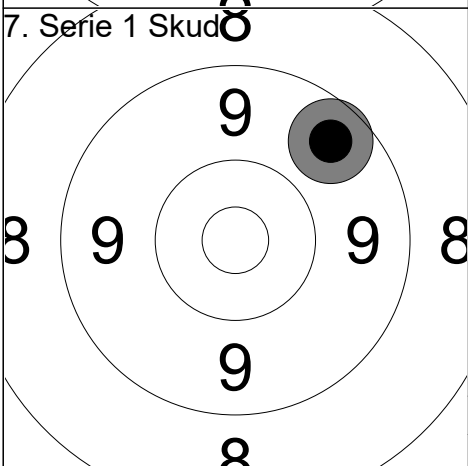
<p>1. Serie 5 Skud </p>	<p>1: 10.1 ↘ 2: 10.9x ↗ 3: 10.3 ↘ 4: 10.1 ↘ 5: 10.8x ↘</p>	<p>2. Serie 1 Skud </p>	<p>1: 9.1 ←</p>								
<table border="1"> <tr><td>Serie</td><td>52.2</td></tr> <tr><td>Total</td><td>52.2</td></tr> </table>		Serie	52.2	Total	52.2	<table border="1"> <tr><td>Serie</td><td>9.1</td></tr> <tr><td>Total</td><td>61.3</td></tr> </table>		Serie	9.1	Total	61.3
Serie	52.2										
Total	52.2										
Serie	9.1										
Total	61.3										
<p>3. Serie 1 Skud </p>	<p>1: 10.7x ↘</p>	<p>4. Serie 1 Skud </p>	<p>1: 10.3 ↓</p>								
<table border="1"> <tr><td>Serie</td><td>10.7</td></tr> <tr><td>Total</td><td>72.0</td></tr> </table>		Serie	10.7	Total	72.0	<table border="1"> <tr><td>Serie</td><td>10.3</td></tr> <tr><td>Total</td><td>82.3</td></tr> </table>		Serie	10.3	Total	82.3
Serie	10.7										
Total	72.0										
Serie	10.3										
Total	82.3										
<p>5. Serie 1 Skud </p>	<p>1: 9.9 ←</p>	<p>6. Serie 1 Skud </p>	<p>1: 10.9x ↗</p>								
<table border="1"> <tr><td>Serie</td><td>9.9</td></tr> <tr><td>Total</td><td>92.2</td></tr> </table>		Serie	9.9	Total	92.2	<table border="1"> <tr><td>Serie</td><td>10.9</td></tr> <tr><td>Total</td><td>103.1</td></tr> </table>		Serie	10.9	Total	103.1
Serie	9.9										
Total	92.2										
Serie	10.9										
Total	103.1										
<p>7. Serie 1 Skud </p>	<p>1: 9.6 ↗</p>										
<table border="1"> <tr><td>Serie</td><td>9.6</td></tr> <tr><td>Total</td><td>112.7</td></tr> </table>		Serie	9.6	Total	112.7						
Serie	9.6										
Total	112.7										

<p>1. Serie 5 Skud </p> <table border="1" style="width:100%; border-collapse: collapse; margin-top: 10px;"> <tr><td style="width:50%;">Serie</td><td style="text-align: right;">51.6</td></tr> <tr><td>Total</td><td style="text-align: right;">51.6</td></tr> </table>	Serie	51.6	Total	51.6	<p>1: 9.5 ←</p> <p>2: 10.4x ←</p> <p>3: 10.9x ↗</p> <p>4: 10.1 ←</p> <p>5: 10.7x ↓</p>	<p>2. Serie 1 Skud </p> <table border="1" style="width:100%; border-collapse: collapse; margin-top: 10px;"> <tr><td style="width:50%;">Serie</td><td style="text-align: right;">10.5</td></tr> <tr><td>Total</td><td style="text-align: right;">62.1</td></tr> </table> <p>1: 10.5x ←</p>	Serie	10.5	Total	62.1
Serie	51.6									
Total	51.6									
Serie	10.5									
Total	62.1									
<p>3. Serie 1 Skud </p> <table border="1" style="width:100%; border-collapse: collapse; margin-top: 10px;"> <tr><td style="width:50%;">Serie</td><td style="text-align: right;">9.9</td></tr> <tr><td>Total</td><td style="text-align: right;">72.0</td></tr> </table>	Serie	9.9	Total	72.0	<p>1: 9.9 ←</p>	<p>4. Serie 1 Skud </p> <table border="1" style="width:100%; border-collapse: collapse; margin-top: 10px;"> <tr><td style="width:50%;">Serie</td><td style="text-align: right;">10.8</td></tr> <tr><td>Total</td><td style="text-align: right;">82.8</td></tr> </table> <p>1: 10.8x ↖</p>	Serie	10.8	Total	82.8
Serie	9.9									
Total	72.0									
Serie	10.8									
Total	82.8									
<p>5. Serie 1 Skud </p> <table border="1" style="width:100%; border-collapse: collapse; margin-top: 10px;"> <tr><td style="width:50%;">Serie</td><td style="text-align: right;">10.4</td></tr> <tr><td>Total</td><td style="text-align: right;">93.2</td></tr> </table>	Serie	10.4	Total	93.2	<p>1: 10.4 ↓</p>	<p>6. Serie 1 Skud </p> <table border="1" style="width:100%; border-collapse: collapse; margin-top: 10px;"> <tr><td style="width:50%;">Serie</td><td style="text-align: right;">10.5</td></tr> <tr><td>Total</td><td style="text-align: right;">103.7</td></tr> </table> <p>1: 10.5x ↘</p>	Serie	10.5	Total	103.7
Serie	10.4									
Total	93.2									
Serie	10.5									
Total	103.7									
<p>7. Serie 1 Skud </p> <table border="1" style="width:100%; border-collapse: collapse; margin-top: 10px;"> <tr><td style="width:50%;">Serie</td><td style="text-align: right;">10.8</td></tr> <tr><td>Total</td><td style="text-align: right;">114.5</td></tr> </table>	Serie	10.8	Total	114.5	<p>1: 10.8x →</p>	<p>8. Serie 1 Skud </p> <table border="1" style="width:100%; border-collapse: collapse; margin-top: 10px;"> <tr><td style="width:50%;">Serie</td><td style="text-align: right;">9.8</td></tr> <tr><td>Total</td><td style="text-align: right;">124.3</td></tr> </table> <p>1: 9.8 ↗</p>	Serie	9.8	Total	124.3
Serie	10.8									
Total	114.5									
Serie	9.8									
Total	124.3									

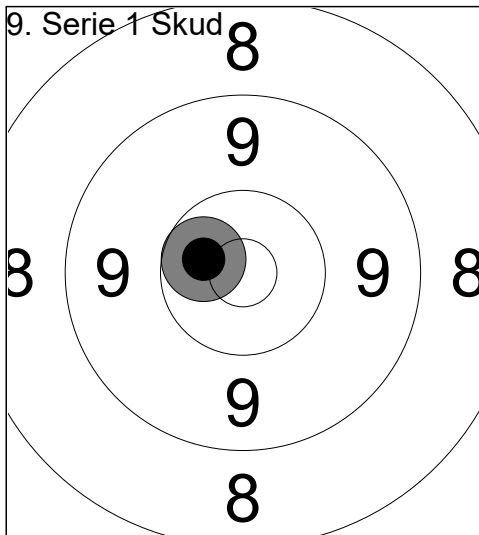

1: 10.6x ←

Serie	10.6
Total	134.9

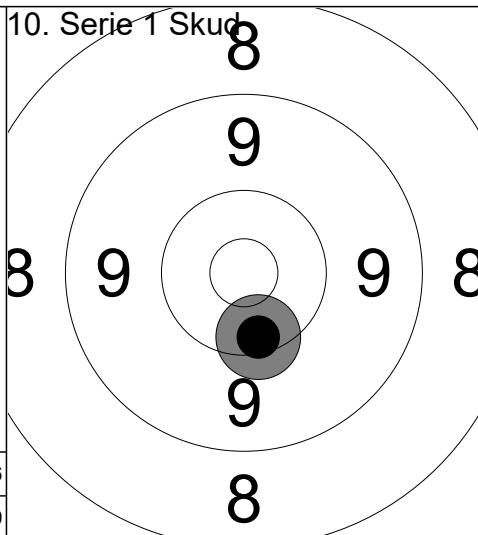

1: 10.3 ↓

Serie	10.3
Total	145.2

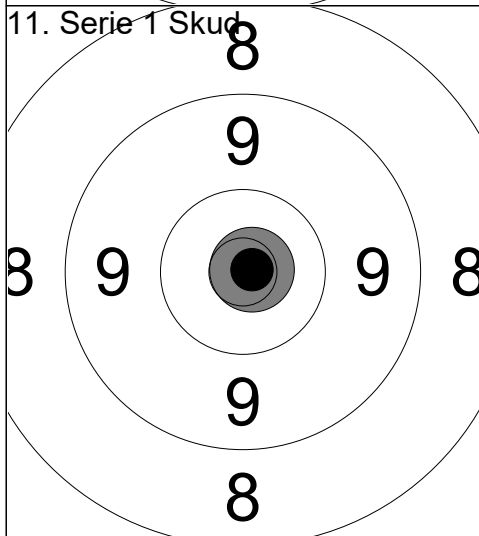

1: 10.9x →

Serie	10.9
Total	156.1

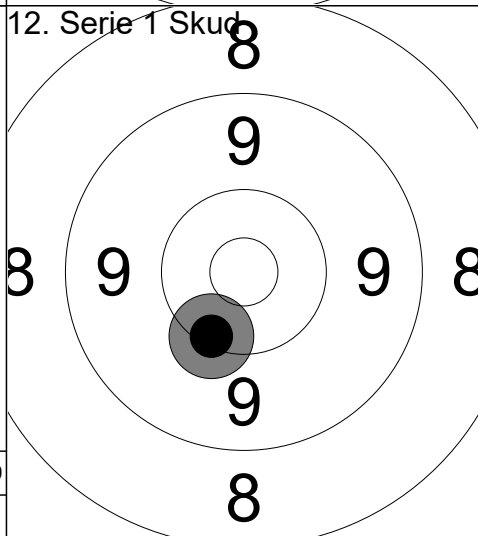

1: 10.3 ↙

Serie	10.3
Total	166.4

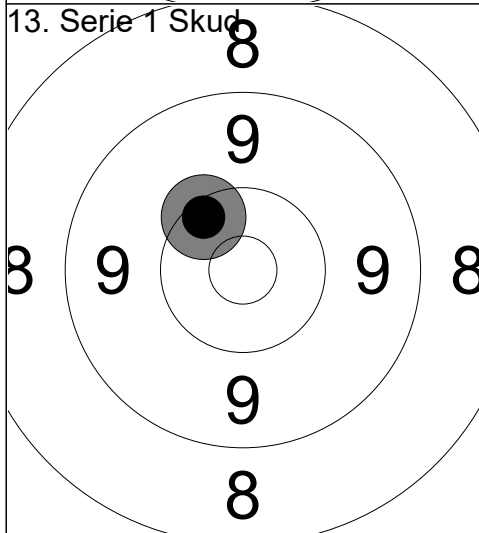





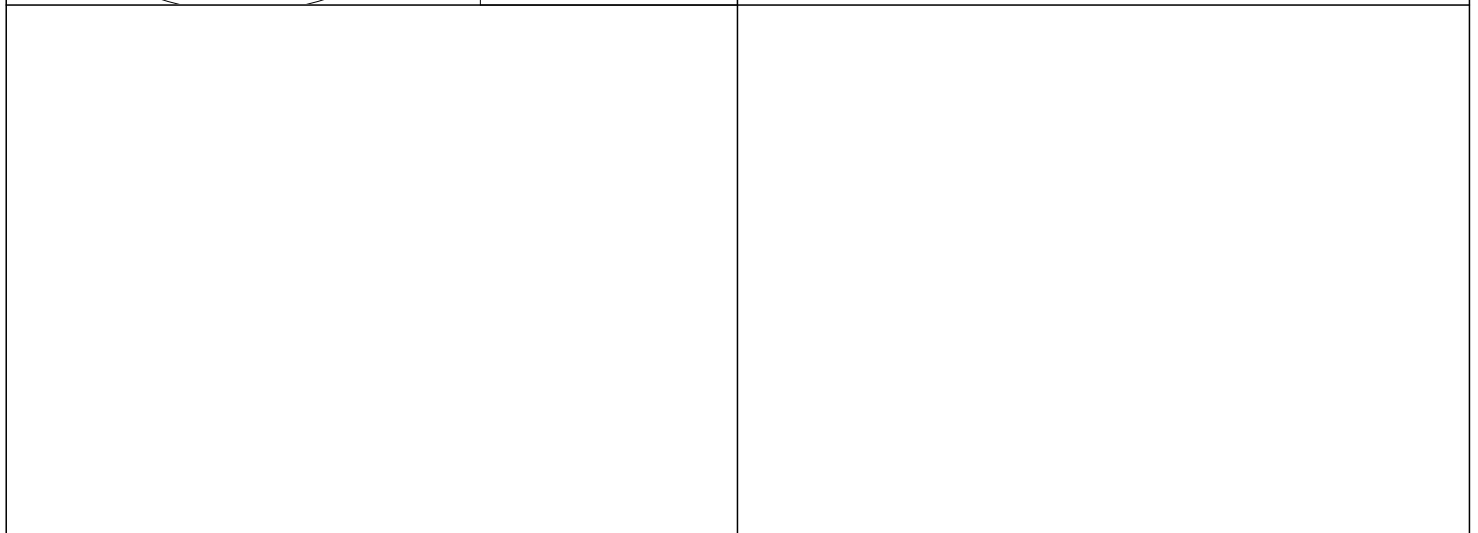



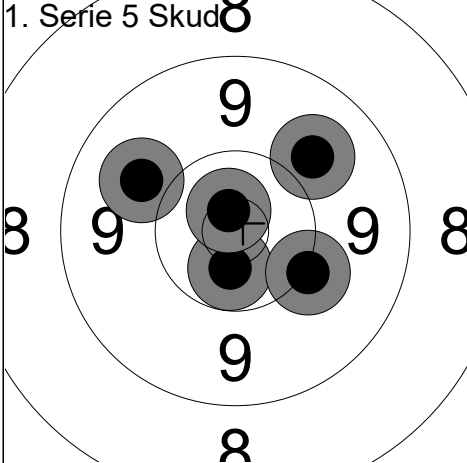

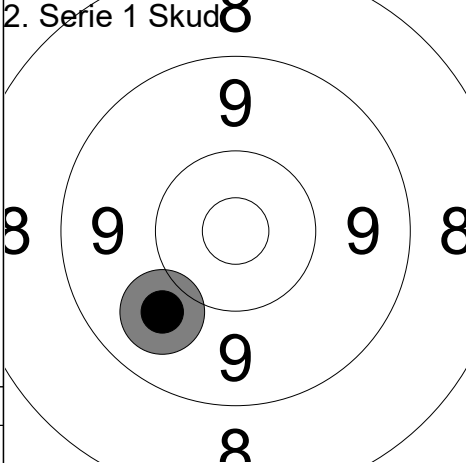

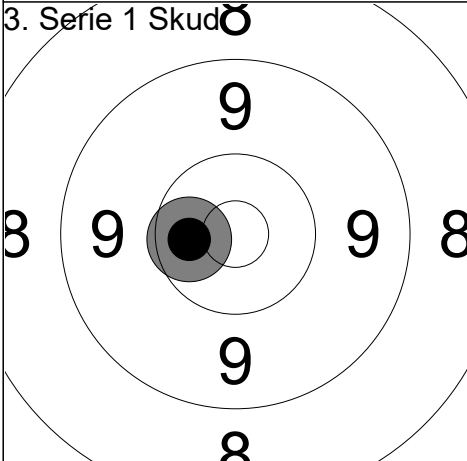

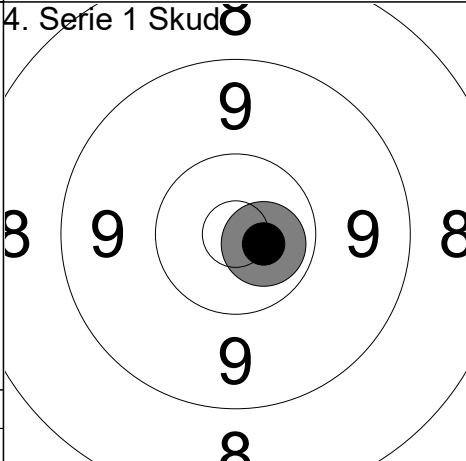
1: 10.3 ↗

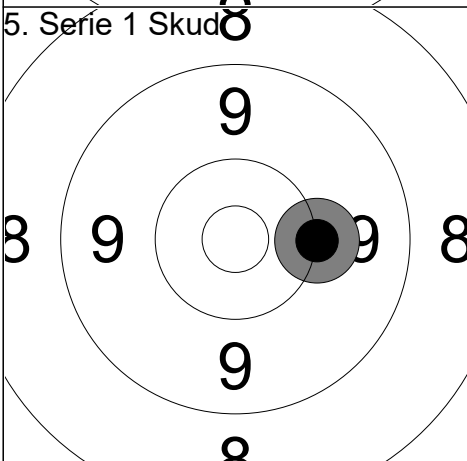
Serie	10.3
Total	176.7

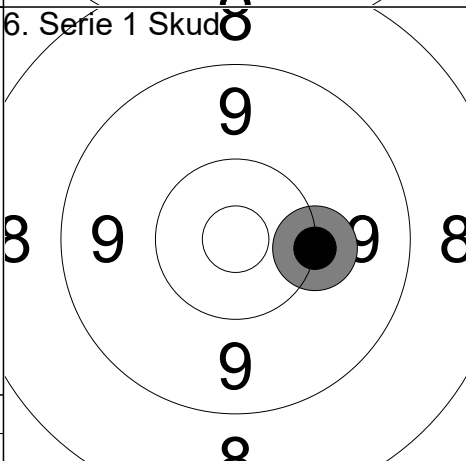

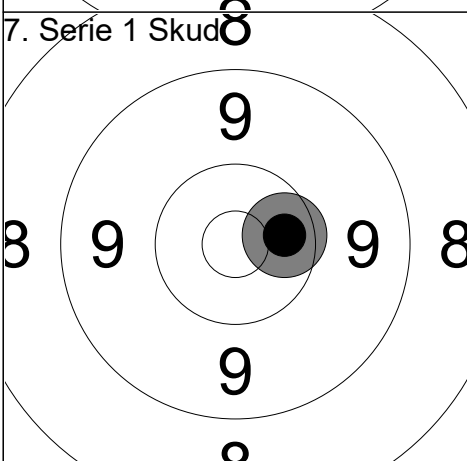
Hold <b>24</b>	Skive <b>3</b>	<b>Frederik Lund-Vogensen</b>	
50m		Ganløse Skytteforening	FJUN
10.08.2025		EM Finale 2025	Hanebjerg Skyttecenter
Kommentar		Signatur	

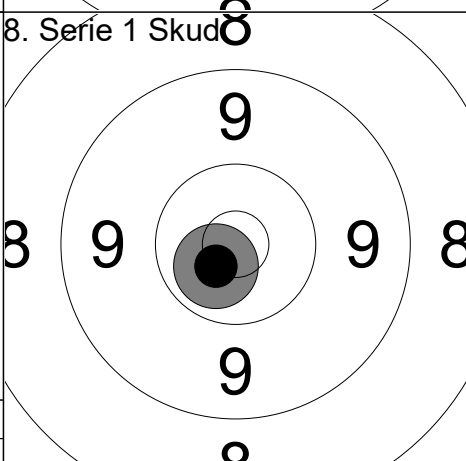
<p>1. Serie 5 Skud </p> 	<p>1: 10.6x ↓ 2: 9.9 ↗ 3: 10.7x ↗ 4: 10.1 ↓ 5: 9.9 ↗</p> <table border="1"> <tr><td>Serie</td><td>51.2</td></tr> <tr><td>Total</td><td>51.2</td></tr> </table>	Serie	51.2	Total	51.2	<p>2. Serie 1 Skud </p> 	<p>1: 9.9 ↙</p> <table border="1"> <tr><td>Serie</td><td>9.9</td></tr> <tr><td>Total</td><td>61.1</td></tr> </table>	Serie	9.9	Total	61.1
Serie	51.2										
Total	51.2										
Serie	9.9										
Total	61.1										
<p>3. Serie 1 Skud </p> 	<p>1: 10.5x ←</p> <table border="1"> <tr><td>Serie</td><td>10.5</td></tr> <tr><td>Total</td><td>71.6</td></tr> </table>	Serie	10.5	Total	71.6	<p>4. Serie 1 Skud </p> 	<p>1: 10.7x →</p> <table border="1"> <tr><td>Serie</td><td>10.7</td></tr> <tr><td>Total</td><td>82.3</td></tr> </table>	Serie	10.7	Total	82.3
Serie	10.5										
Total	71.6										
Serie	10.7										
Total	82.3										
<p>5. Serie 1 Skud </p> 	<p>1: 10.1 →</p> <table border="1"> <tr><td>Serie</td><td>10.1</td></tr> <tr><td>Total</td><td>92.4</td></tr> </table>	Serie	10.1	Total	92.4	<p>6. Serie 1 Skud </p> 	<p>1: 10.2 →</p> <table border="1"> <tr><td>Serie</td><td>10.2</td></tr> <tr><td>Total</td><td>102.6</td></tr> </table>	Serie	10.2	Total	102.6
Serie	10.1										
Total	92.4										
Serie	10.2										
Total	102.6										
<p>7. Serie 1 Skud </p> 	<p>1: 10.5x →</p> <table border="1"> <tr><td>Serie</td><td>10.5</td></tr> <tr><td>Total</td><td>113.1</td></tr> </table>	Serie	10.5	Total	113.1	<p>8. Serie 1 Skud </p> 	<p>1: 10.7x ↙</p> <table border="1"> <tr><td>Serie</td><td>10.7</td></tr> <tr><td>Total</td><td>123.8</td></tr> </table>	Serie	10.7	Total	123.8
Serie	10.5										
Total	113.1										
Serie	10.7										
Total	123.8										

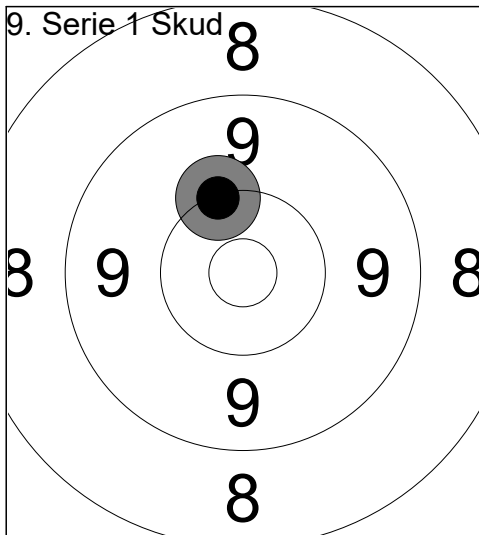

1: 10.2 ↗

Serie	10.2
Total	134.0

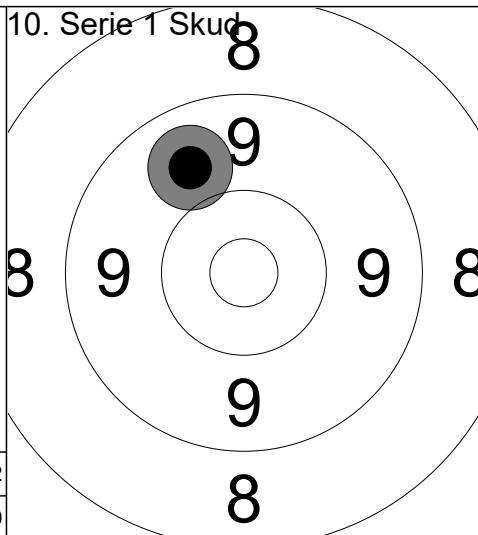

1: 9.8 ↗

Serie	9.8
Total	143.8

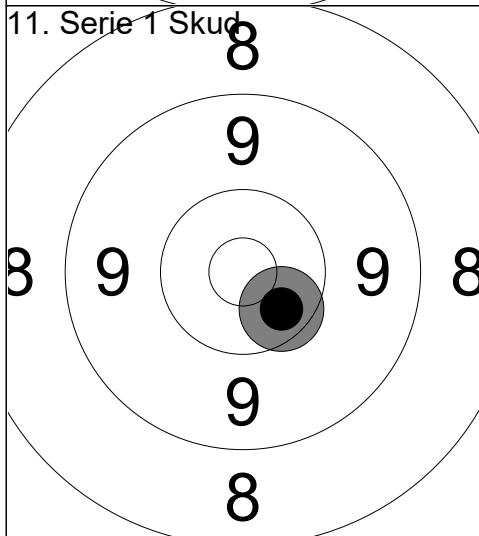

1: 10.4x ↘

Serie	10.4
Total	154.2

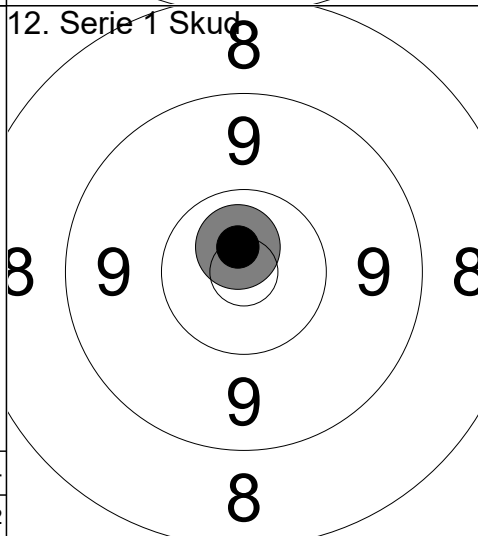

1: 10.7x ↗

Serie	10.7
Total	164.9

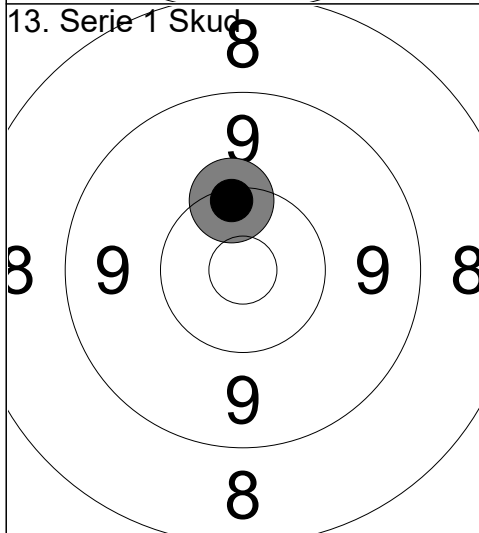

1: 10.3 ↗

Serie	10.3
Total	175.2

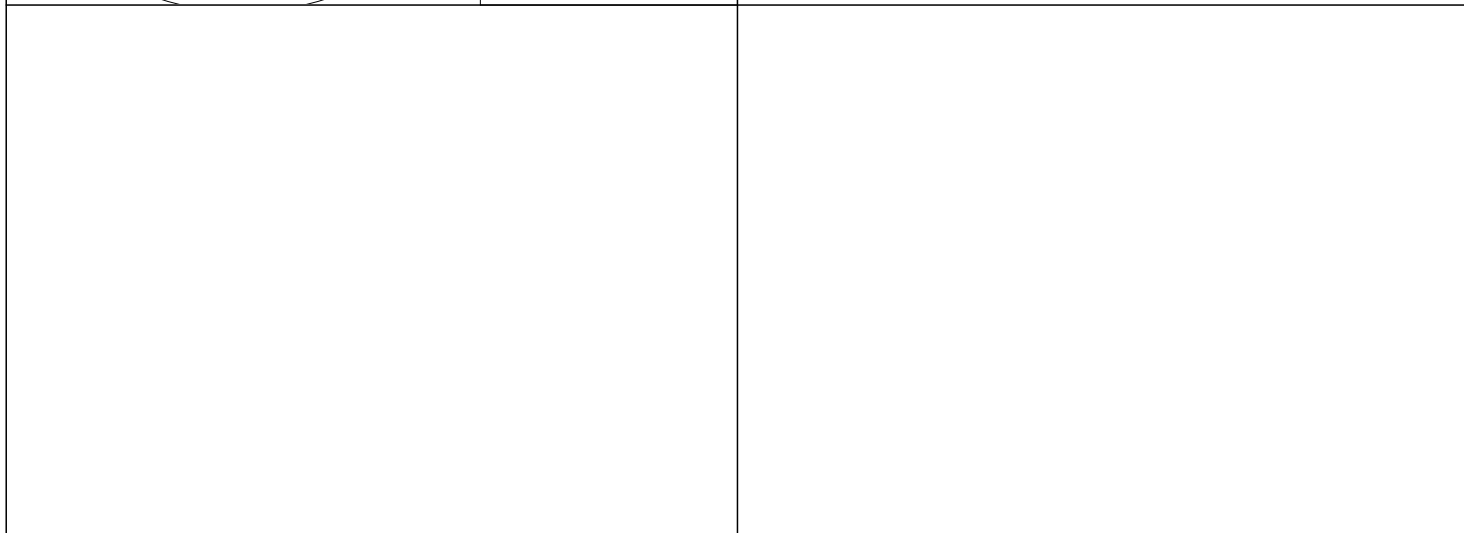

Hold <b>24</b>	Skive <b>4</b>	<b>Malou Schmidt-Larsen</b>	
50m	Ølstykke Skytteforening	FJUN	
10.08.2025	EM Finale 2025	Hanebjerg Skyttecenter	
Kommentar	Signatur		

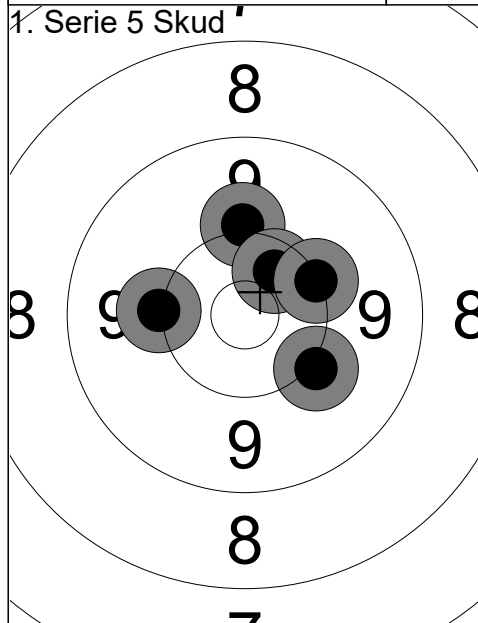

1:	10.1	←
2:	10.1	↑
3:	10.4x	↗
4:	10.1	↘
5:	10.2	↘
Serie		50.9
Total		50.9

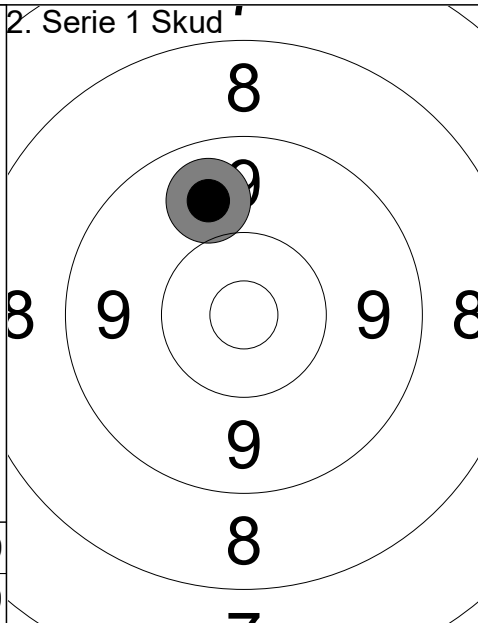

1:	9.8	↑
Serie		9.8
Total		60.7

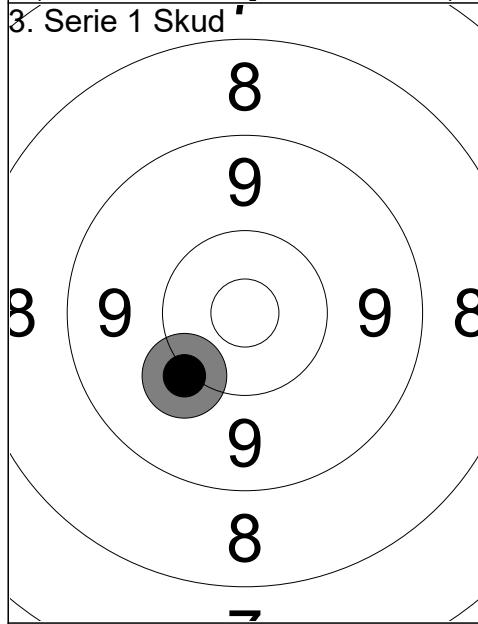

1:	10.1	↘
Serie		10.1
Total		70.8

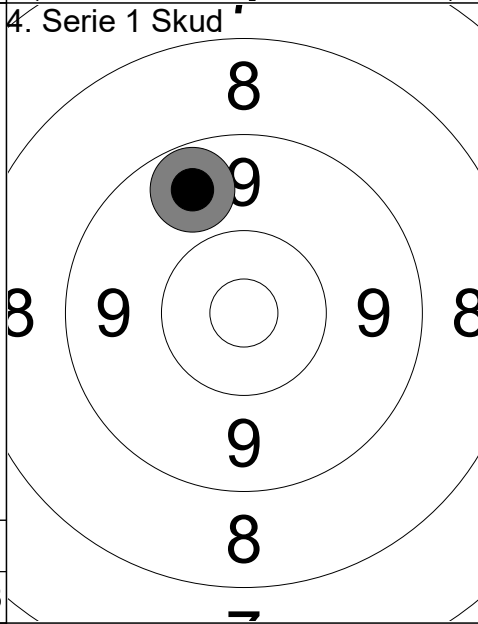

1:	9.6	↑
Serie		9.6
Total		80.4

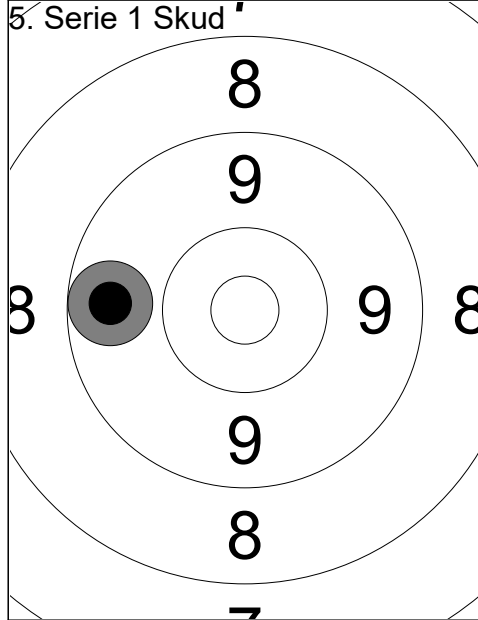

1:	9.6	←
Serie		9.6
Total		90.0

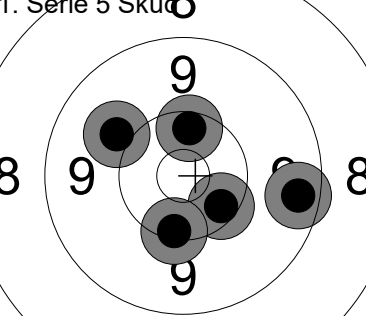
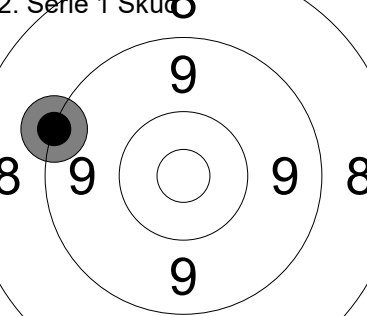
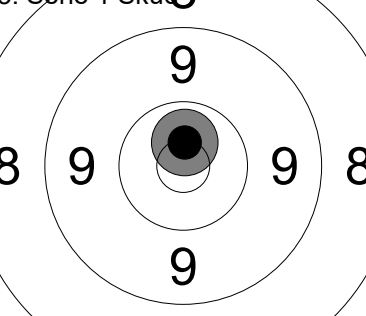
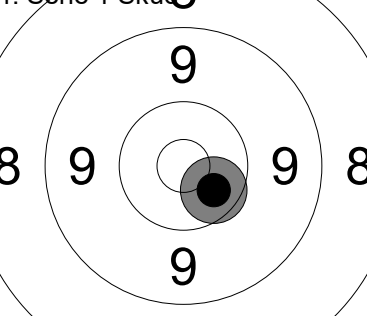
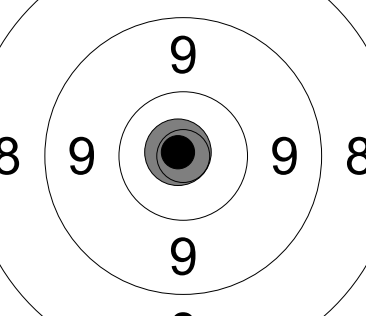
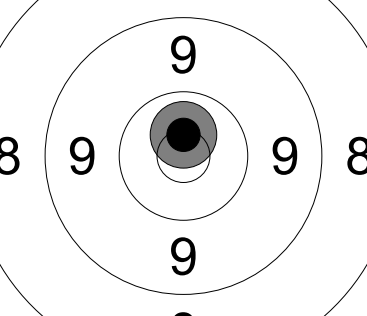
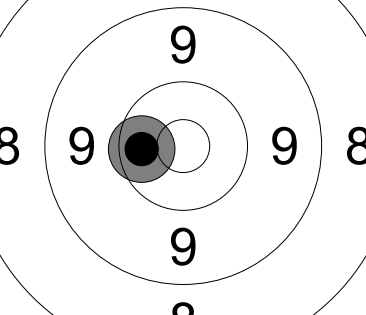
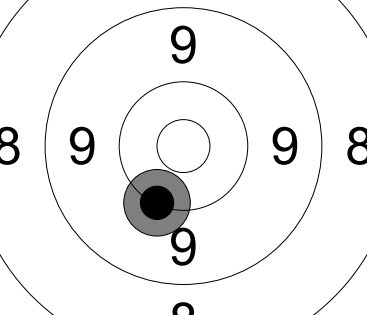
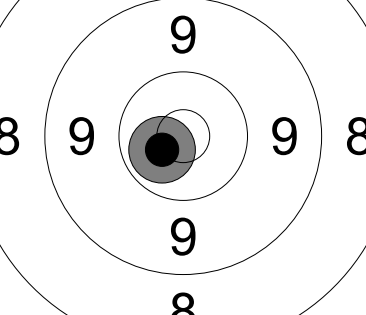
<b>1. Serie 5 Skud</b> 	1: 10.0 ↖ 2: 9.5 → 3: 10.3 ↘ 4: 10.3 ↓ 5: 10.4 ↑	<b>2. Serie 1 Skud</b> 	1: 9.2 ↖								
	<table border="1" style="width:100%; border-collapse: collapse;"> <tr><td style="width:50%;">Serie</td><td style="width:50%;">50.5</td></tr> <tr><td>Total</td><td>50.5</td></tr> </table>	Serie	50.5	Total	50.5		<table border="1" style="width:100%; border-collapse: collapse;"> <tr><td style="width:50%;">Serie</td><td style="width:50%;">9.2</td></tr> <tr><td>Total</td><td>59.7</td></tr> </table>	Serie	9.2	Total	59.7
Serie	50.5										
Total	50.5										
Serie	9.2										
Total	59.7										
<b>3. Serie 1 Skud</b> 	1: 10.7x ↑	<b>4. Serie 1 Skud</b> 	1: 10.5x ↘								
	<table border="1" style="width:100%; border-collapse: collapse;"> <tr><td style="width:50%;">Serie</td><td style="width:50%;">10.7</td></tr> <tr><td>Total</td><td>70.4</td></tr> </table>	Serie	10.7	Total	70.4		<table border="1" style="width:100%; border-collapse: collapse;"> <tr><td style="width:50%;">Serie</td><td style="width:50%;">10.5</td></tr> <tr><td>Total</td><td>80.9</td></tr> </table>	Serie	10.5	Total	80.9
Serie	10.7										
Total	70.4										
Serie	10.5										
Total	80.9										
<b>5. Serie 1 Skud</b> 	1: 10.9x ↖	<b>6. Serie 1 Skud</b> 	1: 10.7x ↑								
	<table border="1" style="width:100%; border-collapse: collapse;"> <tr><td style="width:50%;">Serie</td><td style="width:50%;">10.9</td></tr> <tr><td>Total</td><td>91.8</td></tr> </table>	Serie	10.9	Total	91.8		<table border="1" style="width:100%; border-collapse: collapse;"> <tr><td style="width:50%;">Serie</td><td style="width:50%;">10.7</td></tr> <tr><td>Total</td><td>102.5</td></tr> </table>	Serie	10.7	Total	102.5
Serie	10.9										
Total	91.8										
Serie	10.7										
Total	102.5										
<b>7. Serie 1 Skud</b> 	1: 10.4x ←	<b>8. Serie 1 Skud</b> 	1: 10.2 ↘								
	<table border="1" style="width:100%; border-collapse: collapse;"> <tr><td style="width:50%;">Serie</td><td style="width:50%;">10.4</td></tr> <tr><td>Total</td><td>112.9</td></tr> </table>	Serie	10.4	Total	112.9		<table border="1" style="width:100%; border-collapse: collapse;"> <tr><td style="width:50%;">Serie</td><td style="width:50%;">10.2</td></tr> <tr><td>Total</td><td>123.1</td></tr> </table>	Serie	10.2	Total	123.1
Serie	10.4										
Total	112.9										
Serie	10.2										
Total	123.1										
<b>9. Serie 1 Skud</b> 	1: 10.6x ↖										
	<table border="1" style="width:100%; border-collapse: collapse;"> <tr><td style="width:50%;">Serie</td><td style="width:50%;">10.6</td></tr> <tr><td>Total</td><td>133.7</td></tr> </table>	Serie	10.6	Total	133.7						
Serie	10.6										
Total	133.7										

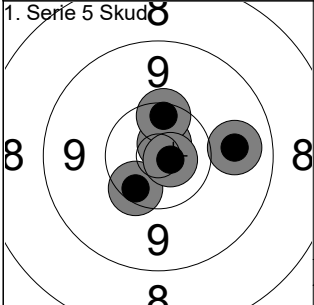
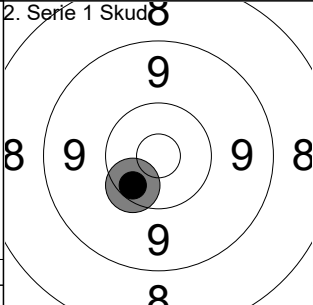
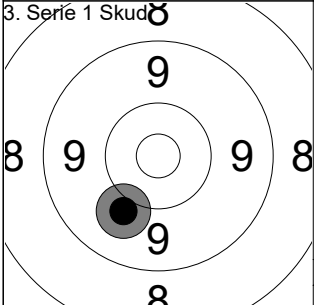
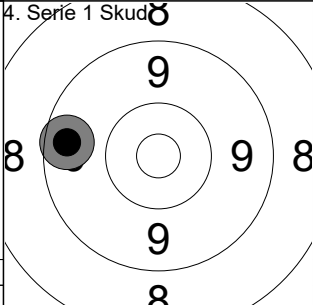
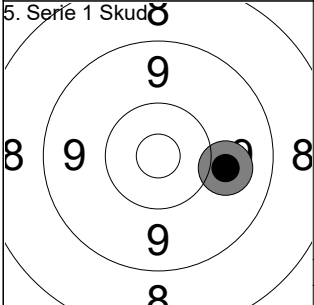
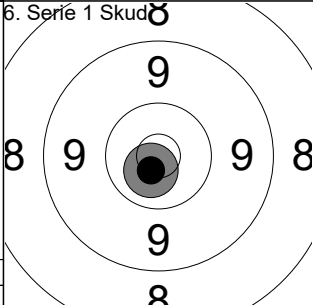
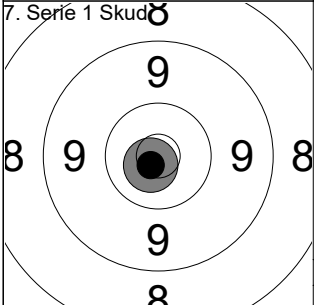
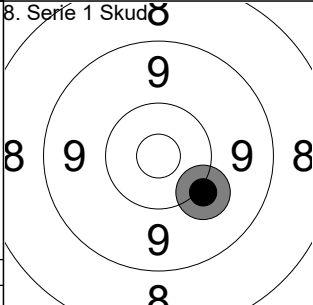
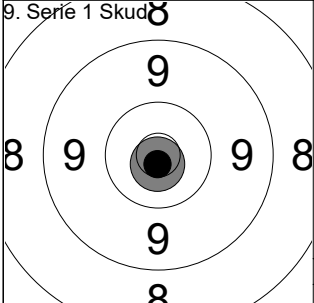
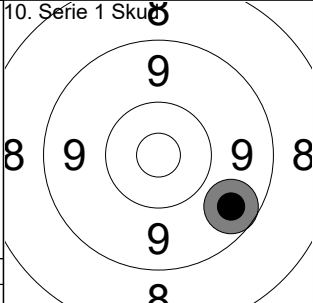
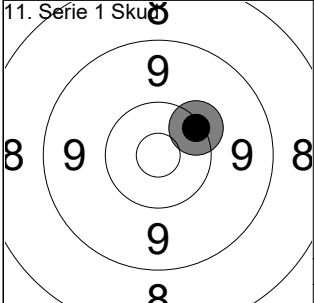
1. Serie 5 Skud 	1: 9.8 2: 10.7x 3: 10.3 4: 10.3 5: 10.8x	2. Serie 1 Skud 	1: 10.4								
	<table border="1" style="width:100%; border-collapse: collapse;"> <tr><td style="width:80%;">Serie</td><td style="text-align: right;">51.9</td></tr> <tr><td>Total</td><td style="text-align: right;">51.9</td></tr> </table>	Serie	51.9	Total	51.9		<table border="1" style="width:100%; border-collapse: collapse;"> <tr><td style="width:80%;">Serie</td><td style="text-align: right;">10.4</td></tr> <tr><td>Total</td><td style="text-align: right;">62.3</td></tr> </table>	Serie	10.4	Total	62.3
Serie	51.9										
Total	51.9										
Serie	10.4										
Total	62.3										
3. Serie 1 Skud 	1: 10.0	4. Serie 1 Skud 	1: 9.5								
	<table border="1" style="width:100%; border-collapse: collapse;"> <tr><td style="width:80%;">Serie</td><td style="text-align: right;">10.0</td></tr> <tr><td>Total</td><td style="text-align: right;">72.3</td></tr> </table>	Serie	10.0	Total	72.3		<table border="1" style="width:100%; border-collapse: collapse;"> <tr><td style="width:80%;">Serie</td><td style="text-align: right;">9.5</td></tr> <tr><td>Total</td><td style="text-align: right;">81.8</td></tr> </table>	Serie	9.5	Total	81.8
Serie	10.0										
Total	72.3										
Serie	9.5										
Total	81.8										
5. Serie 1 Skud 	1: 9.9	6. Serie 1 Skud 	1: 10.7x								
	<table border="1" style="width:100%; border-collapse: collapse;"> <tr><td style="width:80%;">Serie</td><td style="text-align: right;">9.9</td></tr> <tr><td>Total</td><td style="text-align: right;">91.7</td></tr> </table>	Serie	9.9	Total	91.7		<table border="1" style="width:100%; border-collapse: collapse;"> <tr><td style="width:80%;">Serie</td><td style="text-align: right;">10.7</td></tr> <tr><td>Total</td><td style="text-align: right;">102.4</td></tr> </table>	Serie	10.7	Total	102.4
Serie	9.9										
Total	91.7										
Serie	10.7										
Total	102.4										
7. Serie 1 Skud 	1: 10.8x	8. Serie 1 Skud 	1: 10.1								
	<table border="1" style="width:100%; border-collapse: collapse;"> <tr><td style="width:80%;">Serie</td><td style="text-align: right;">10.8</td></tr> <tr><td>Total</td><td style="text-align: right;">113.2</td></tr> </table>	Serie	10.8	Total	113.2		<table border="1" style="width:100%; border-collapse: collapse;"> <tr><td style="width:80%;">Serie</td><td style="text-align: right;">10.1</td></tr> <tr><td>Total</td><td style="text-align: right;">123.3</td></tr> </table>	Serie	10.1	Total	123.3
Serie	10.8										
Total	113.2										
Serie	10.1										
Total	123.3										
9. Serie 1 Skud 	1: 10.8x	10. Serie 1 Skud 	1: 9.6								
	<table border="1" style="width:100%; border-collapse: collapse;"> <tr><td style="width:80%;">Serie</td><td style="text-align: right;">10.8</td></tr> <tr><td>Total</td><td style="text-align: right;">134.1</td></tr> </table>	Serie	10.8	Total	134.1		<table border="1" style="width:100%; border-collapse: collapse;"> <tr><td style="width:80%;">Serie</td><td style="text-align: right;">9.6</td></tr> <tr><td>Total</td><td style="text-align: right;">143.7</td></tr> </table>	Serie	9.6	Total	143.7
Serie	10.8										
Total	134.1										
Serie	9.6										
Total	143.7										
11. Serie 1 Skud 	1: 10.3										
	<table border="1" style="width:100%; border-collapse: collapse;"> <tr><td style="width:80%;">Serie</td><td style="text-align: right;">10.3</td></tr> <tr><td>Total</td><td style="text-align: right;">154.0</td></tr> </table>	Serie	10.3	Total	154.0						
Serie	10.3										
Total	154.0										

Hold <b>24</b>	Skive <b>7</b>	<b>Palle Kofoed</b>		
50m	Østerlars Skytteforening		FLIG	
10.08.2025	EM Finale 2025		Hanebjerg Skyttecenter	
Kommentar	Signatur			

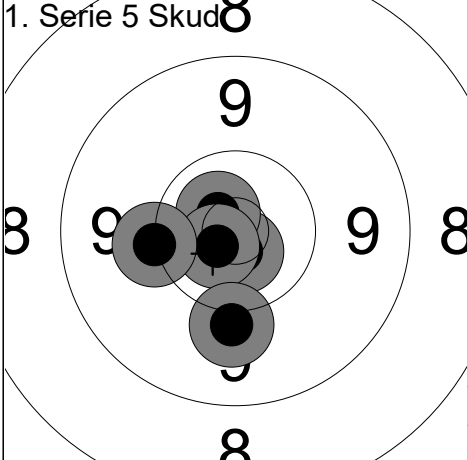
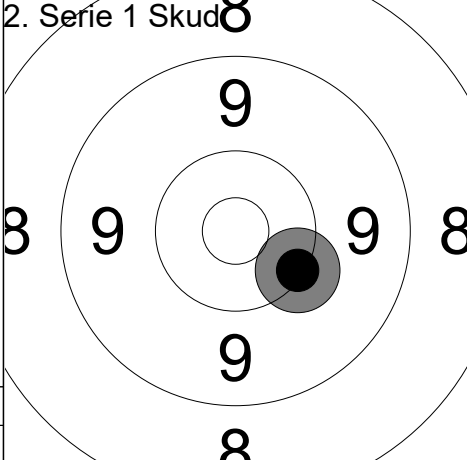
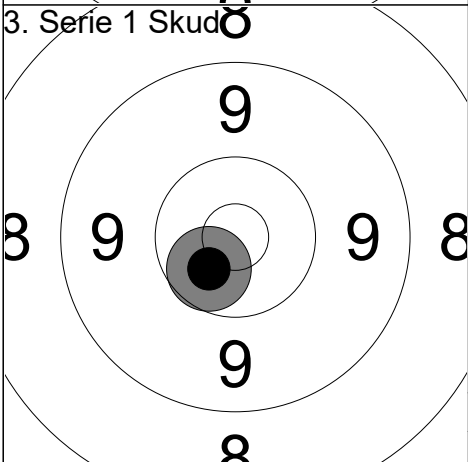
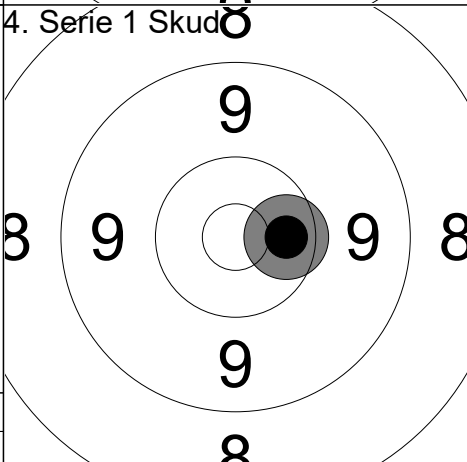
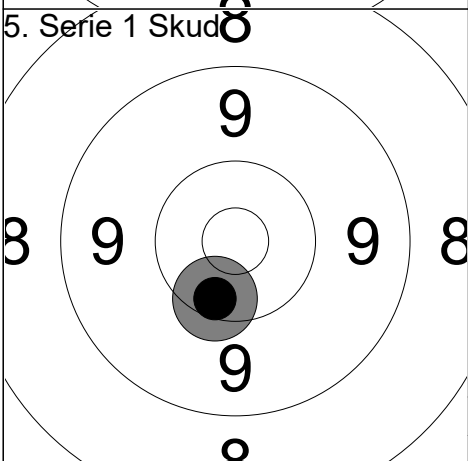
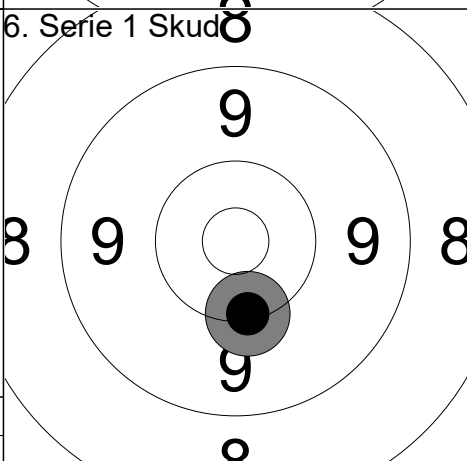
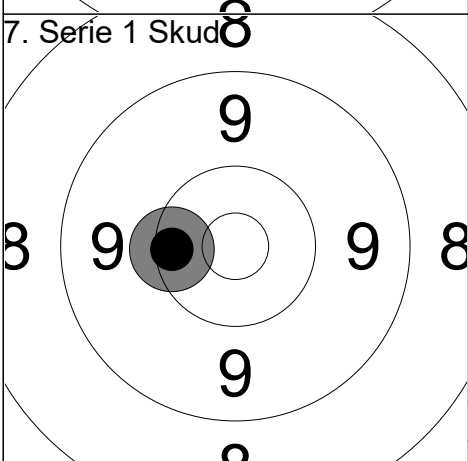
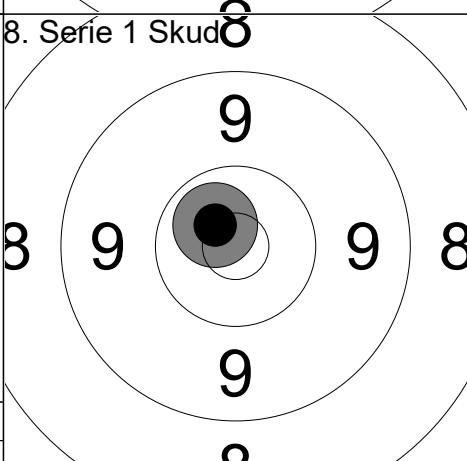
1. Serie 5 Skud 	1: 10.7x ↘ 2: 10.7x ↗ 3: 10.7x ↙ 4: 10.1 ← 5: 10.0 ↓	2. Serie 1 Skud 	1: 10.2 ↗								
	1: 10.5x ↙		1: 10.4x →								
	1: 10.4 ↓		1: 10.2 ↓								
	1: 10.3 ←		1: 10.7x ↗								
<table border="1"> <tr><td>Serie</td><td>52.2</td></tr> <tr><td>Total</td><td>52.2</td></tr> </table>	Serie	52.2	Total	52.2		<table border="1"> <tr><td>Serie</td><td>10.2</td></tr> <tr><td>Total</td><td>62.4</td></tr> </table>	Serie	10.2	Total	62.4	
Serie	52.2										
Total	52.2										
Serie	10.2										
Total	62.4										
		<table border="1"> <tr><td>Serie</td><td>10.4</td></tr> <tr><td>Total</td><td>83.3</td></tr> </table>	Serie	10.4	Total	83.3					
Serie	10.4										
Total	83.3										
		<table border="1"> <tr><td>Serie</td><td>10.2</td></tr> <tr><td>Total</td><td>103.9</td></tr> </table>	Serie	10.2	Total	103.9					
Serie	10.2										
Total	103.9										
		<table border="1"> <tr><td>Serie</td><td>10.7</td></tr> <tr><td>Total</td><td>124.9</td></tr> </table>	Serie	10.7	Total	124.9					
Serie	10.7										
Total	124.9										

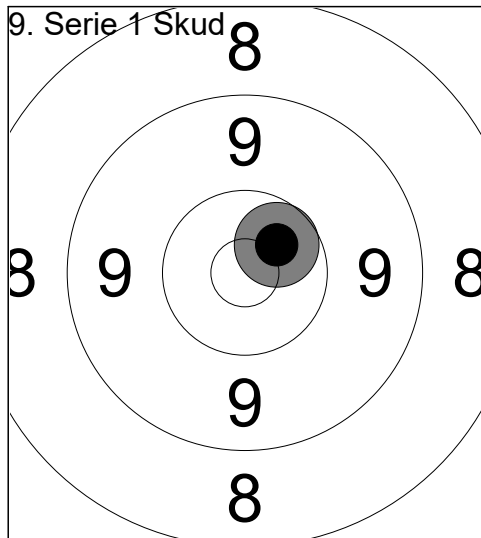

1: 10.5x ↗

Serie	10.5
Total	135.4

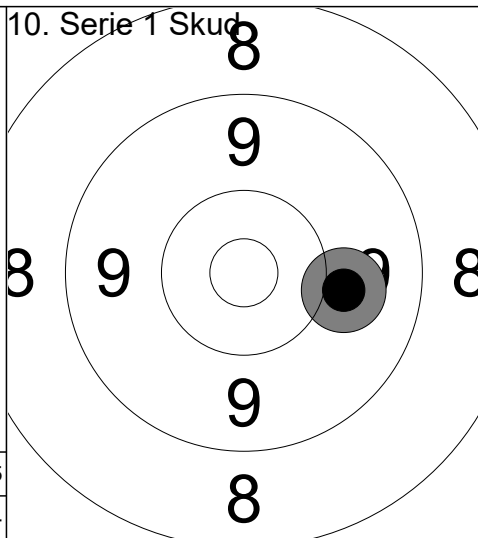

1: 10.0 →

Serie	10.0
Total	145.4

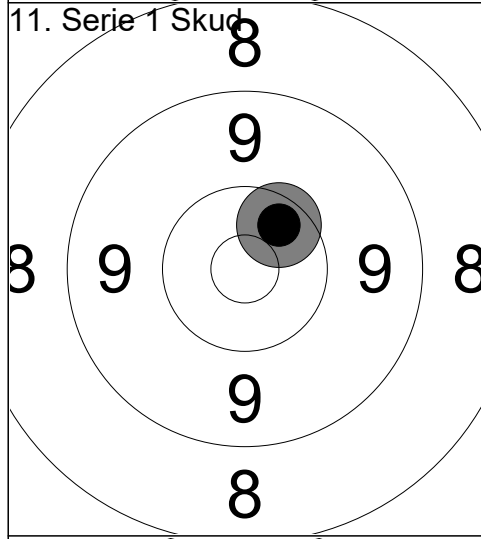

1: 10.4x ↗

Serie	10.4
Total	155.8

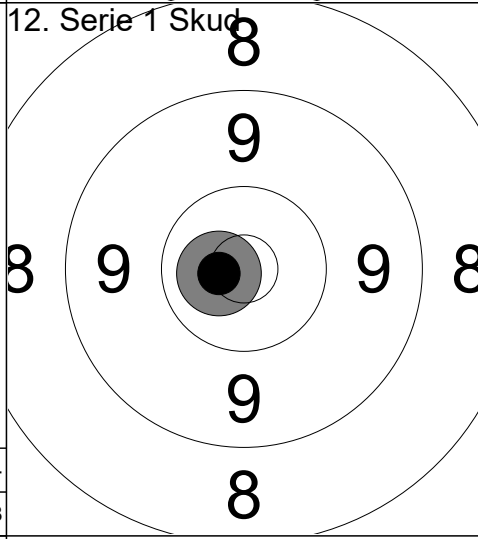

1: 10.7x ←

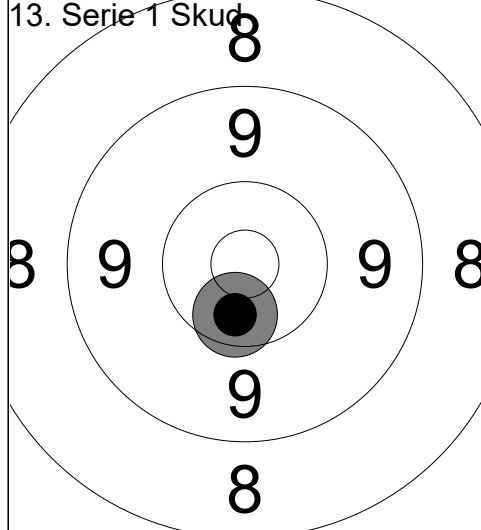

Serie	10.7
Total	166.5

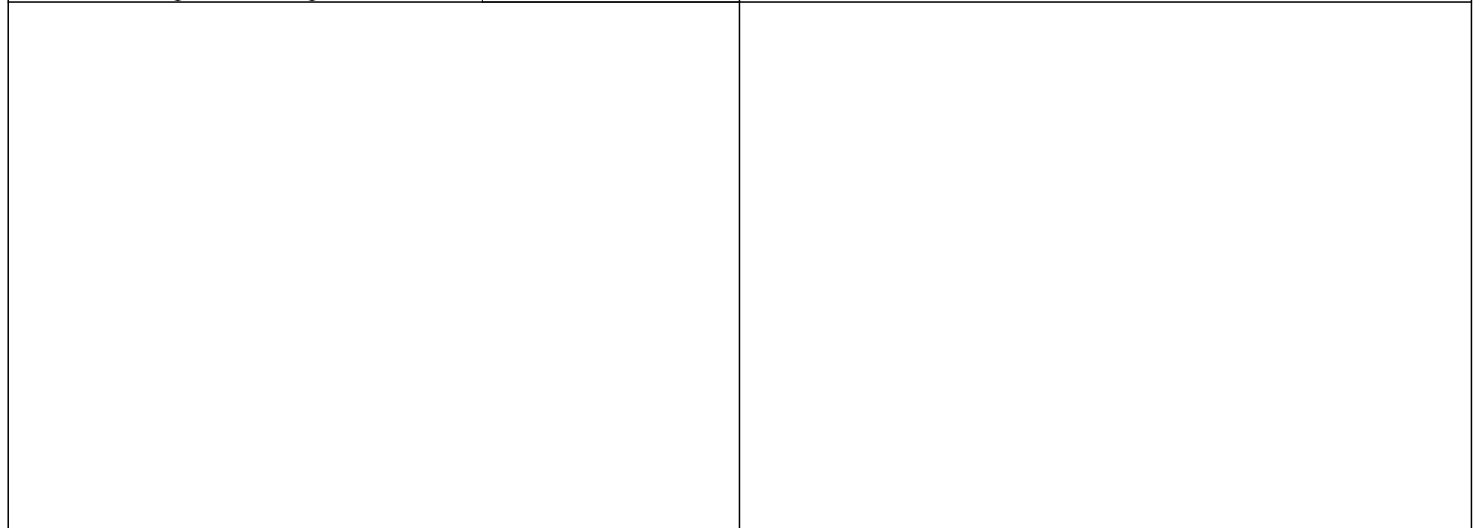

1: 10.4x ↓

Serie	10.4
Total	176.9

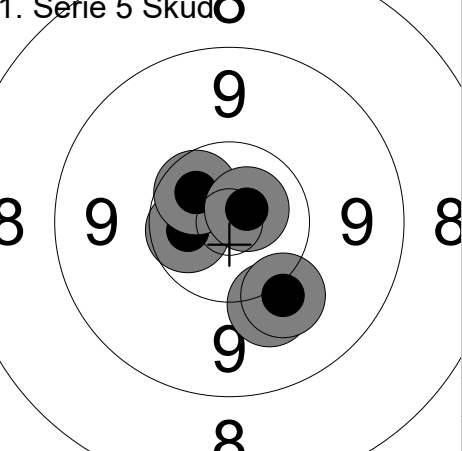

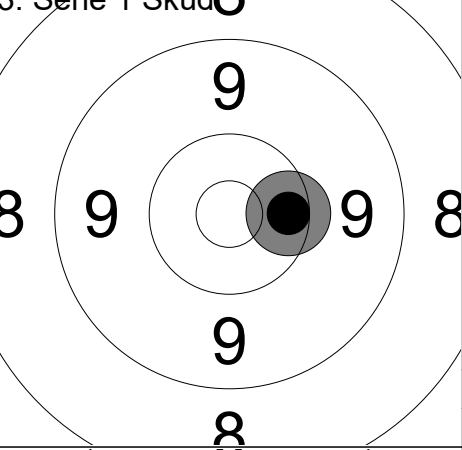
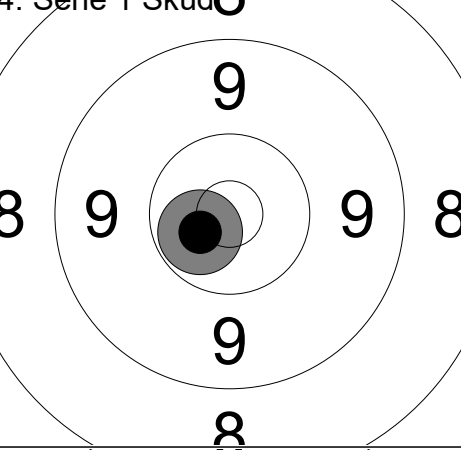
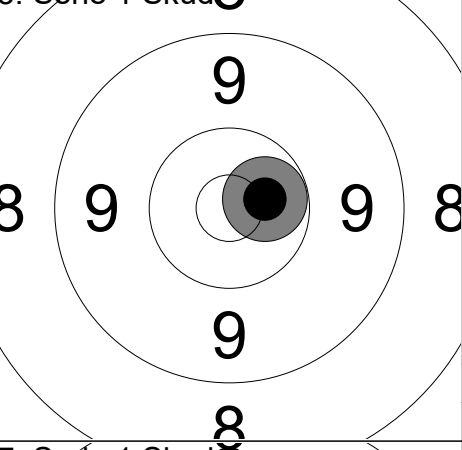
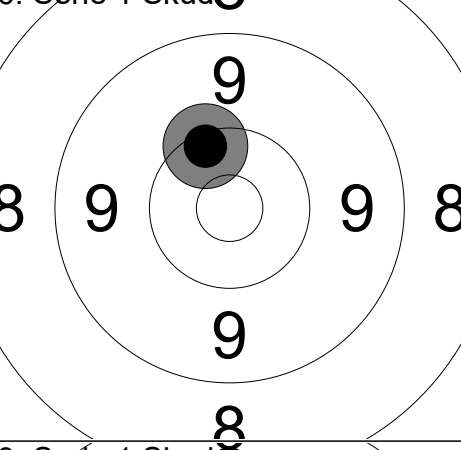
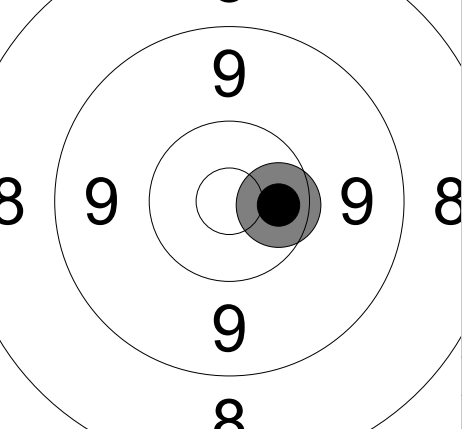
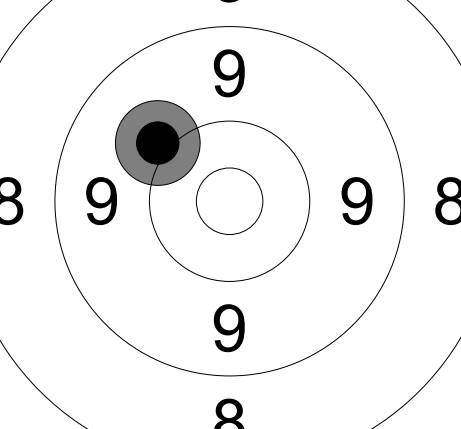
<p>1. Serie 5 Skud </p>  <table border="1" style="width:100%; border-collapse: collapse; margin-top: 10px;"> <tr><td>Serie</td><td style="text-align: right;">51.8</td></tr> <tr><td>Total</td><td style="text-align: right;">51.8</td></tr> </table>	Serie	51.8	Total	51.8	<p>1: 10.5x ←</p> <p>2: 10.5x ↗</p> <p>3: 10.0 ↓</p> <p>4: 10.7x ↗</p> <p>5: 10.1 ↓</p>	<p>2. Serie 1 Skud </p>  <table border="1" style="width:100%; border-collapse: collapse; margin-top: 10px;"> <tr><td>Serie</td><td style="text-align: right;">9.9</td></tr> <tr><td>Total</td><td style="text-align: right;">61.7</td></tr> </table>	Serie	9.9	Total	61.7
Serie	51.8									
Total	51.8									
Serie	9.9									
Total	61.7									
<p>3. Serie 1 Skud </p>  <table border="1" style="width:100%; border-collapse: collapse; margin-top: 10px;"> <tr><td>Serie</td><td style="text-align: right;">10.4</td></tr> <tr><td>Total</td><td style="text-align: right;">72.1</td></tr> </table>	Serie	10.4	Total	72.1	<p>1: 10.4 →</p>	<p>4. Serie 1 Skud </p>  <table border="1" style="width:100%; border-collapse: collapse; margin-top: 10px;"> <tr><td>Serie</td><td style="text-align: right;">10.6</td></tr> <tr><td>Total</td><td style="text-align: right;">82.7</td></tr> </table>	Serie	10.6	Total	82.7
Serie	10.4									
Total	72.1									
Serie	10.6									
Total	82.7									
<p>5. Serie 1 Skud </p>  <table border="1" style="width:100%; border-collapse: collapse; margin-top: 10px;"> <tr><td>Serie</td><td style="text-align: right;">10.6</td></tr> <tr><td>Total</td><td style="text-align: right;">93.3</td></tr> </table>	Serie	10.6	Total	93.3	<p>1: 10.6x →</p>	<p>6. Serie 1 Skud </p>  <table border="1" style="width:100%; border-collapse: collapse; margin-top: 10px;"> <tr><td>Serie</td><td style="text-align: right;">10.3</td></tr> <tr><td>Total</td><td style="text-align: right;">103.6</td></tr> </table>	Serie	10.3	Total	103.6
Serie	10.6									
Total	93.3									
Serie	10.3									
Total	103.6									
<p>7. Serie 1 Skud </p>  <table border="1" style="width:100%; border-collapse: collapse; margin-top: 10px;"> <tr><td>Serie</td><td style="text-align: right;">10.5</td></tr> <tr><td>Total</td><td style="text-align: right;">114.1</td></tr> </table>	Serie	10.5	Total	114.1	<p>1: 10.5x →</p>	<p>8. Serie 1 Skud </p>  <table border="1" style="width:100%; border-collapse: collapse; margin-top: 10px;"> <tr><td>Serie</td><td style="text-align: right;">10.0</td></tr> <tr><td>Total</td><td style="text-align: right;">124.1</td></tr> </table>	Serie	10.0	Total	124.1
Serie	10.5									
Total	114.1									
Serie	10.0									
Total	124.1									

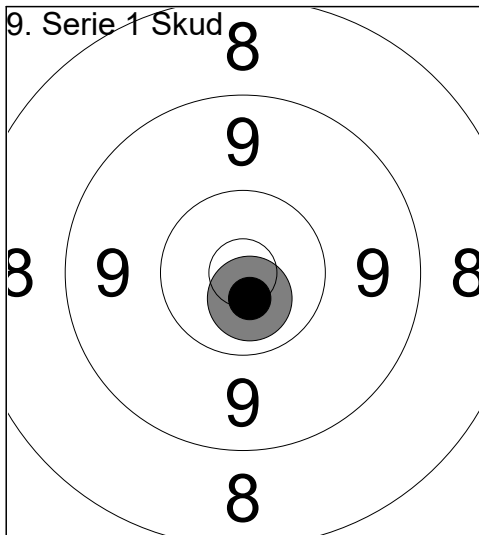

1: 10.7x ↘

Serie	10.7
Total	134.8

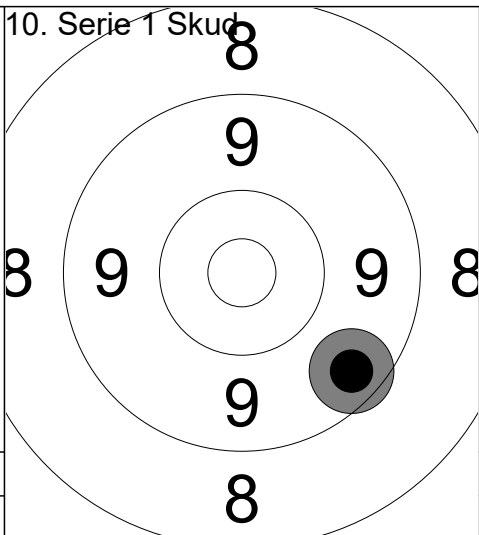

1: 9.5 ↘

Serie	9.5
Total	144.3

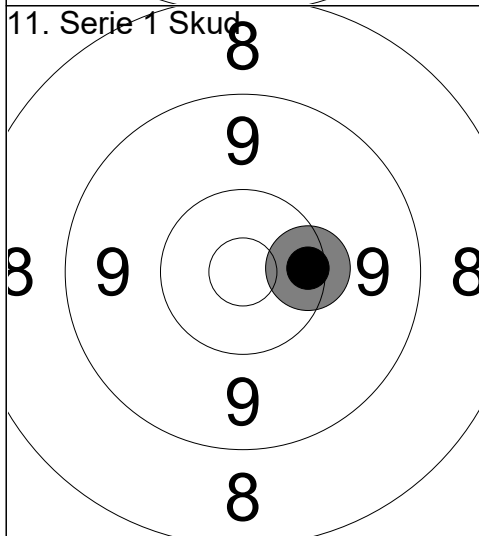

1: 10.3 →

Serie	10.3
Total	154.6

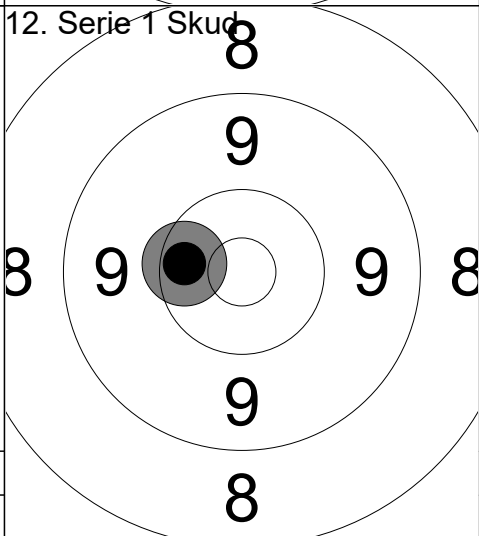

1: 10.4 ←

Serie	10.4
Total	165.0

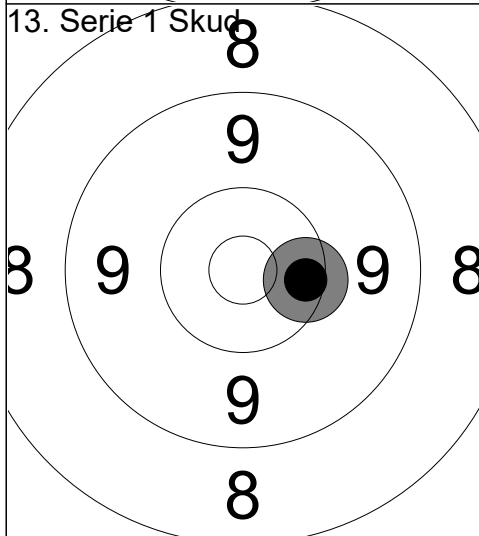

1: 10.3 →

Serie	10.3
Total	175.3

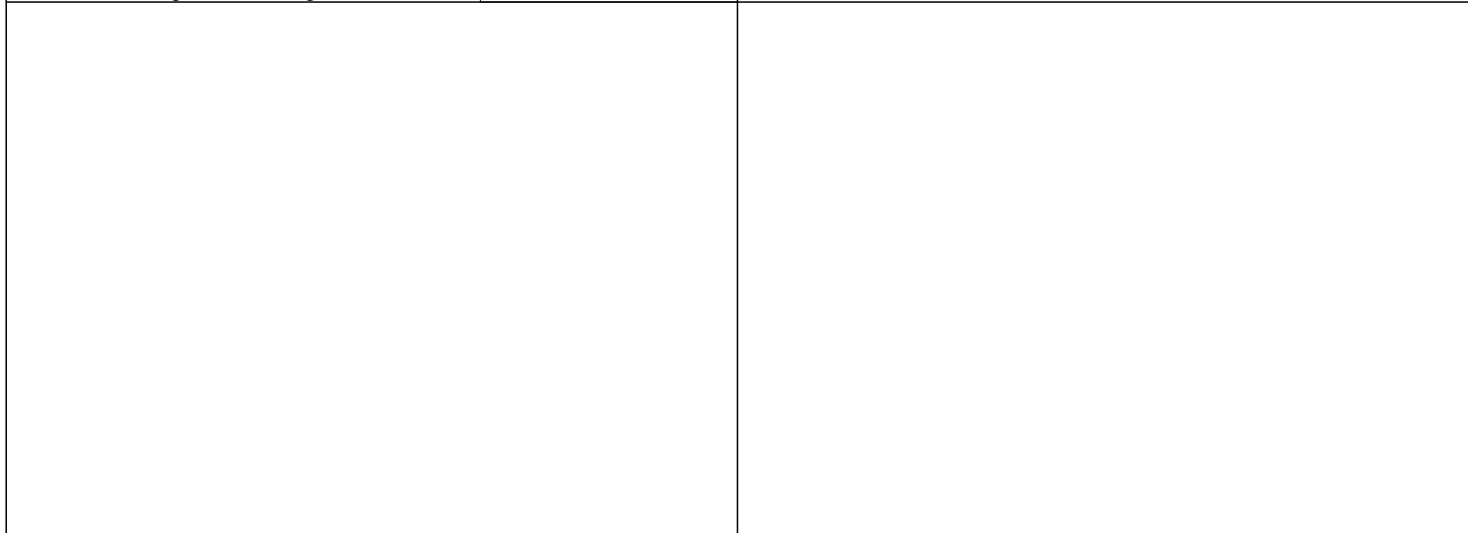

<p>1. Serie 5 Skud </p>	<p>1: 9.8 → 2: 10.7x ↑ 3: 10.1 → 4: 9.4 → 5: 10.5x ↓</p>	<p>2. Serie 1 Skud </p>	<p>1: 10.7x →</p>								
	<table border="1" style="width:100%; border-collapse: collapse;"> <tr><td>Serie</td><td style="text-align: right;">50.5</td></tr> <tr><td>Total</td><td style="text-align: right;">50.5</td></tr> </table>	Serie	50.5	Total	50.5		<table border="1" style="width:100%; border-collapse: collapse;"> <tr><td>Serie</td><td style="text-align: right;">10.7</td></tr> <tr><td>Total</td><td style="text-align: right;">61.2</td></tr> </table>	Serie	10.7	Total	61.2
Serie	50.5										
Total	50.5										
Serie	10.7										
Total	61.2										
<p>3. Serie 1 Skud </p>	<p>1: 10.0 ←</p>	<p>4. Serie 1 Skud </p>	<p>1: 10.4 ↓</p>								
	<table border="1" style="width:100%; border-collapse: collapse;"> <tr><td>Serie</td><td style="text-align: right;">10.0</td></tr> <tr><td>Total</td><td style="text-align: right;">71.2</td></tr> </table>	Serie	10.0	Total	71.2		<table border="1" style="width:100%; border-collapse: collapse;"> <tr><td>Serie</td><td style="text-align: right;">10.4</td></tr> <tr><td>Total</td><td style="text-align: right;">81.6</td></tr> </table>	Serie	10.4	Total	81.6
Serie	10.0										
Total	71.2										
Serie	10.4										
Total	81.6										
<p>5. Serie 1 Skud </p>	<p>1: 10.2 ←</p>	<p>6. Serie 1 Skud </p>	<p>1: 10.3 ↑</p>								
	<table border="1" style="width:100%; border-collapse: collapse;"> <tr><td>Serie</td><td style="text-align: right;">10.2</td></tr> <tr><td>Total</td><td style="text-align: right;">91.8</td></tr> </table>	Serie	10.2	Total	91.8		<table border="1" style="width:100%; border-collapse: collapse;"> <tr><td>Serie</td><td style="text-align: right;">10.3</td></tr> <tr><td>Total</td><td style="text-align: right;">102.1</td></tr> </table>	Serie	10.3	Total	102.1
Serie	10.2										
Total	91.8										
Serie	10.3										
Total	102.1										
<p>7. Serie 1 Skud </p>	<p>1: 10.0 →</p>	<p>8. Serie 1 Skud </p>	<p>1: 10.5x ←</p>								
	<table border="1" style="width:100%; border-collapse: collapse;"> <tr><td>Serie</td><td style="text-align: right;">10.0</td></tr> <tr><td>Total</td><td style="text-align: right;">112.1</td></tr> </table>	Serie	10.0	Total	112.1		<table border="1" style="width:100%; border-collapse: collapse;"> <tr><td>Serie</td><td style="text-align: right;">10.5</td></tr> <tr><td>Total</td><td style="text-align: right;">122.6</td></tr> </table>	Serie	10.5	Total	122.6
Serie	10.0										
Total	112.1										
Serie	10.5										
Total	122.6										
<p>9. Serie 1 Skud </p>	<p>1: 10.6x ↓</p>										
	<table border="1" style="width:100%; border-collapse: collapse;"> <tr><td>Serie</td><td style="text-align: right;">10.6</td></tr> <tr><td>Total</td><td style="text-align: right;">133.2</td></tr> </table>	Serie	10.6	Total	133.2						
Serie	10.6										
Total	133.2										

Hold <b>24</b>	Skive <b>10</b>	<b>Bjoern Thomsen</b>	
50m	Ganløse Skytteforening	FLIG	
10.08.2025	EM Finale 2025	Hanebjerg Skyttecenter	
Kommentar	Signatur		

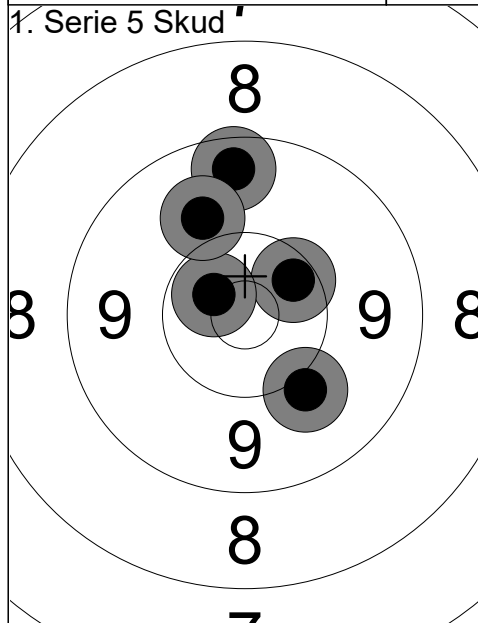

1:	9.5	↑
2:	10.4	↗
3:	10.6x	↖
4:	10.0	↘
5:	9.9	↗
Serie		50.4
Total		50.4

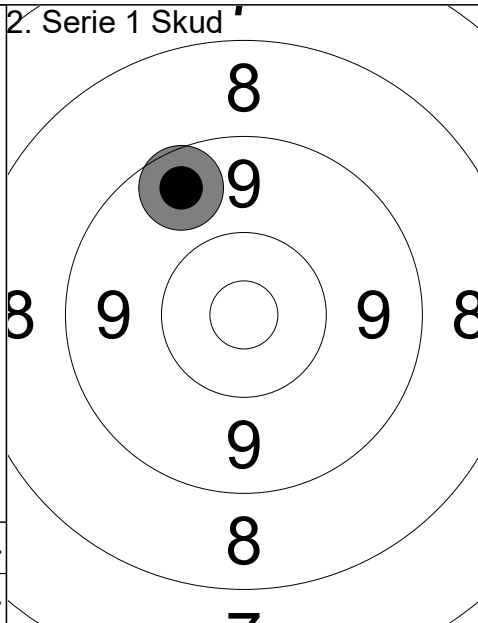

1:	9.6	↖
Serie		9.6
Total		60.0

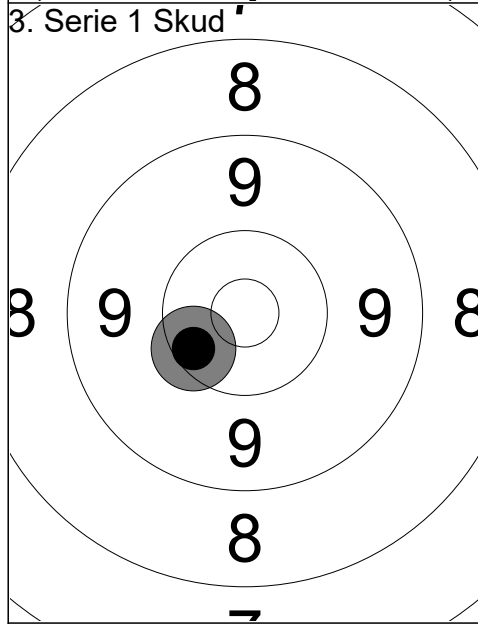

1:	10.3	↙
Serie		10.3
Total		70.3

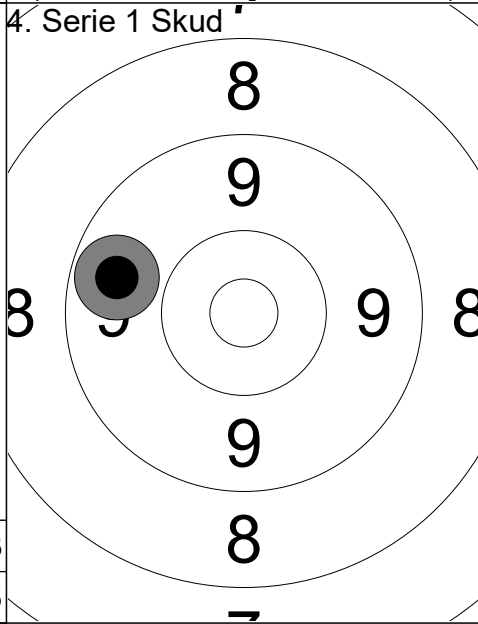

1:	9.7	↙
Serie		9.7
Total		80.0

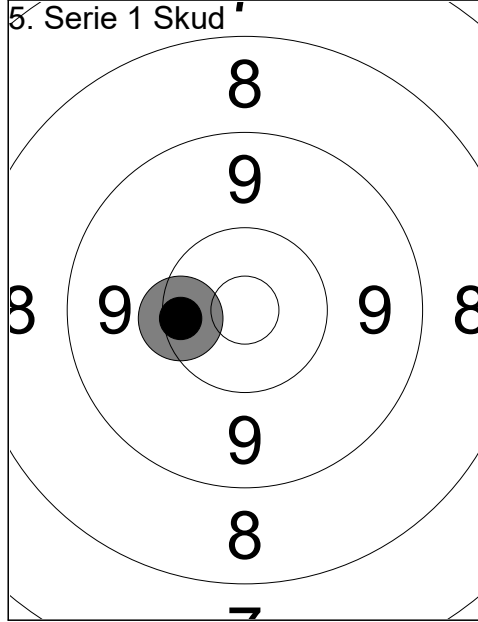

1:	10.3	↙
Serie		10.3
Total		90.3

<p>1. Serie 5 Skud </p>	<p>1: 10.7x ↘ 2: 10.7x ↗ 3: 9.4 → 4: 10.1 ↘ 5: 10.8x ↑</p>	<p>2. Serie 1 Skud </p>	<p>1: 10.4x ↘</p>								
	<table border="1" style="width:100%; border-collapse: collapse;"> <tr><td style="width:80%;">Serie</td><td style="text-align: right;">51.7</td></tr> <tr><td>Total</td><td style="text-align: right;">51.7</td></tr> </table>	Serie	51.7	Total	51.7		<table border="1" style="width:100%; border-collapse: collapse;"> <tr><td style="width:80%;">Serie</td><td style="text-align: right;">10.4</td></tr> <tr><td>Total</td><td style="text-align: right;">62.1</td></tr> </table>	Serie	10.4	Total	62.1
Serie	51.7										
Total	51.7										
Serie	10.4										
Total	62.1										
<p>3. Serie 1 Skud </p>	<p>1: 10.4 ↑</p>	<p>4. Serie 1 Skud </p>	<p>1: 9.9 ↘</p>								
	<table border="1" style="width:100%; border-collapse: collapse;"> <tr><td style="width:80%;">Serie</td><td style="text-align: right;">10.4</td></tr> <tr><td>Total</td><td style="text-align: right;">72.5</td></tr> </table>	Serie	10.4	Total	72.5		<table border="1" style="width:100%; border-collapse: collapse;"> <tr><td style="width:80%;">Serie</td><td style="text-align: right;">9.9</td></tr> <tr><td>Total</td><td style="text-align: right;">82.4</td></tr> </table>	Serie	9.9	Total	82.4
Serie	10.4										
Total	72.5										
Serie	9.9										
Total	82.4										
<p>5. Serie 1 Skud </p>	<p>1: 10.4 ↘</p>	<p>6. Serie 1 Skud </p>	<p>1: 10.2 ↘</p>								
	<table border="1" style="width:100%; border-collapse: collapse;"> <tr><td style="width:80%;">Serie</td><td style="text-align: right;">10.4</td></tr> <tr><td>Total</td><td style="text-align: right;">92.8</td></tr> </table>	Serie	10.4	Total	92.8		<table border="1" style="width:100%; border-collapse: collapse;"> <tr><td style="width:80%;">Serie</td><td style="text-align: right;">10.2</td></tr> <tr><td>Total</td><td style="text-align: right;">103.0</td></tr> </table>	Serie	10.2	Total	103.0
Serie	10.4										
Total	92.8										
Serie	10.2										
Total	103.0										
<p>7. Serie 1 Skud </p>	<p>1: 9.6 ↑</p>	<p>8. Serie 1 Skud </p>	<p>1: 10.2 ↗</p>								
	<table border="1" style="width:100%; border-collapse: collapse;"> <tr><td style="width:80%;">Serie</td><td style="text-align: right;">9.6</td></tr> <tr><td>Total</td><td style="text-align: right;">112.6</td></tr> </table>	Serie	9.6	Total	112.6		<table border="1" style="width:100%; border-collapse: collapse;"> <tr><td style="width:80%;">Serie</td><td style="text-align: right;">10.2</td></tr> <tr><td>Total</td><td style="text-align: right;">122.8</td></tr> </table>	Serie	10.2	Total	122.8
Serie	9.6										
Total	112.6										
Serie	10.2										
Total	122.8										
<p>9. Serie 1 Skud </p>	<p>1: 10.5x ↙</p>	<p>10. Serie 1 Skud </p>	<p>1: 9.9 ↘</p>								
	<table border="1" style="width:100%; border-collapse: collapse;"> <tr><td style="width:80%;">Serie</td><td style="text-align: right;">10.5</td></tr> <tr><td>Total</td><td style="text-align: right;">133.3</td></tr> </table>	Serie	10.5	Total	133.3		<table border="1" style="width:100%; border-collapse: collapse;"> <tr><td style="width:80%;">Serie</td><td style="text-align: right;">9.9</td></tr> <tr><td>Total</td><td style="text-align: right;">143.2</td></tr> </table>	Serie	9.9	Total	143.2
Serie	10.5										
Total	133.3										
Serie	9.9										
Total	143.2										
<p>11. Serie 1 Skud </p>	<p>1: 10.8x ↘</p>										
	<table border="1" style="width:100%; border-collapse: collapse;"> <tr><td style="width:80%;">Serie</td><td style="text-align: right;">10.8</td></tr> <tr><td>Total</td><td style="text-align: right;">154.0</td></tr> </table>	Serie	10.8	Total	154.0						
Serie	10.8										
Total	154.0										

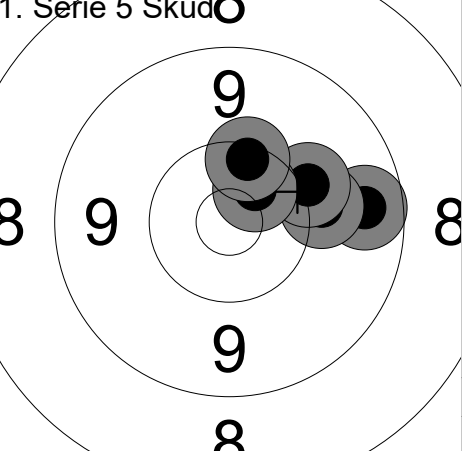
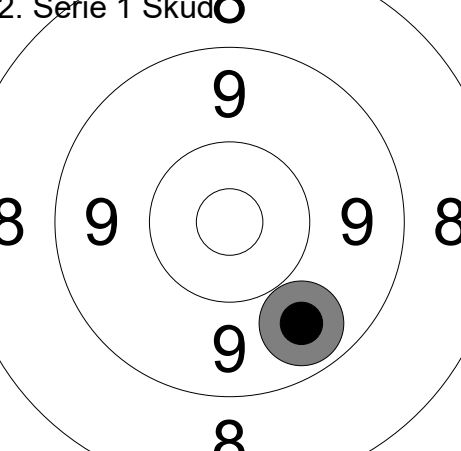
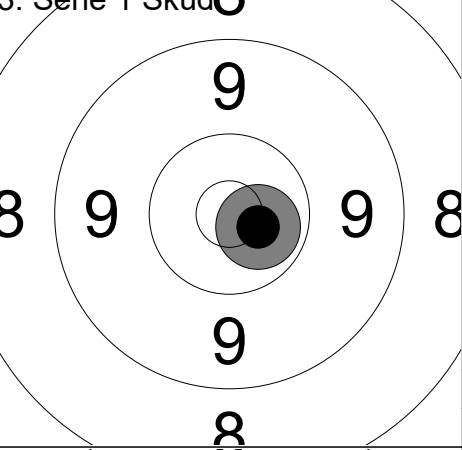
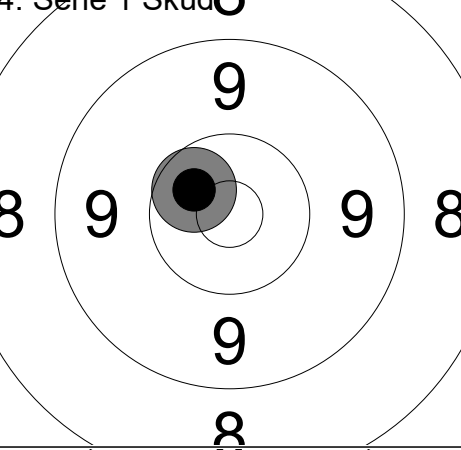
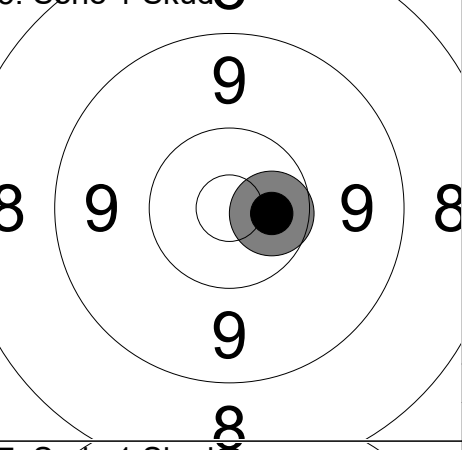
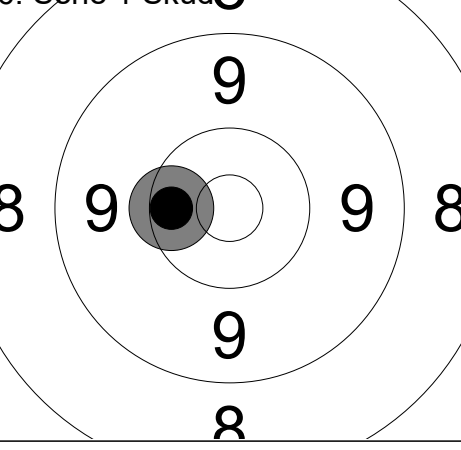
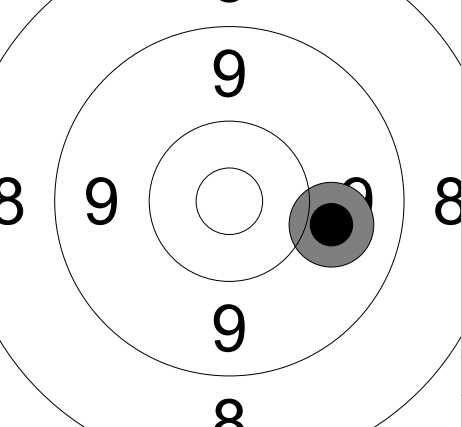
<p>1. Serie 5 Skud </p>  <table border="1" style="width:100%; border-collapse: collapse; margin-top: 10px;"> <tr><td style="width:50%;">1: 9.6</td><td style="width:50%; text-align: right;">→</td></tr> <tr><td>2: 10.0</td><td style="text-align: right;">→</td></tr> <tr><td>3: 10.1</td><td style="text-align: right;">→</td></tr> <tr><td>4: 10.5x</td><td style="text-align: right;">↗</td></tr> <tr><td>5: 10.3</td><td style="text-align: right;">↑</td></tr> </table> <table border="1" style="width:100%; border-collapse: collapse; margin-top: 10px;"> <tr><td style="width:50%;">Serie</td><td style="width:50%; text-align: right;">50.5</td></tr> <tr><td>Total</td><td style="text-align: right;">50.5</td></tr> </table>	1: 9.6	→	2: 10.0	→	3: 10.1	→	4: 10.5x	↗	5: 10.3	↑	Serie	50.5	Total	50.5	<p>2. Serie 1 Skud </p>  <table border="1" style="width:100%; border-collapse: collapse; margin-top: 10px;"> <tr><td style="width:50%;">1: 9.7</td><td style="width:50%; text-align: right;">↘</td></tr> </table> <table border="1" style="width:100%; border-collapse: collapse; margin-top: 10px;"> <tr><td style="width:50%;">Serie</td><td style="width:50%; text-align: right;">9.7</td></tr> <tr><td>Total</td><td style="text-align: right;">60.2</td></tr> </table>	1: 9.7	↘	Serie	9.7	Total	60.2
1: 9.6	→																				
2: 10.0	→																				
3: 10.1	→																				
4: 10.5x	↗																				
5: 10.3	↑																				
Serie	50.5																				
Total	50.5																				
1: 9.7	↘																				
Serie	9.7																				
Total	60.2																				
<p>3. Serie 1 Skud </p>  <table border="1" style="width:100%; border-collapse: collapse; margin-top: 10px;"> <tr><td style="width:50%;">1: 10.6x</td><td style="width:50%; text-align: right;">⇒</td></tr> </table> <table border="1" style="width:100%; border-collapse: collapse; margin-top: 10px;"> <tr><td style="width:50%;">Serie</td><td style="width:50%; text-align: right;">10.6</td></tr> <tr><td>Total</td><td style="text-align: right;">70.8</td></tr> </table>	1: 10.6x	⇒	Serie	10.6	Total	70.8	<p>4. Serie 1 Skud </p>  <table border="1" style="width:100%; border-collapse: collapse; margin-top: 10px;"> <tr><td style="width:50%;">1: 10.5x</td><td style="width:50%; text-align: right;">↖</td></tr> </table> <table border="1" style="width:100%; border-collapse: collapse; margin-top: 10px;"> <tr><td style="width:50%;">Serie</td><td style="width:50%; text-align: right;">10.5</td></tr> <tr><td>Total</td><td style="text-align: right;">81.3</td></tr> </table>	1: 10.5x	↖	Serie	10.5	Total	81.3								
1: 10.6x	⇒																				
Serie	10.6																				
Total	70.8																				
1: 10.5x	↖																				
Serie	10.5																				
Total	81.3																				
<p>5. Serie 1 Skud </p>  <table border="1" style="width:100%; border-collapse: collapse; margin-top: 10px;"> <tr><td style="width:50%;">1: 10.5x</td><td style="width:50%; text-align: right;">→</td></tr> </table> <table border="1" style="width:100%; border-collapse: collapse; margin-top: 10px;"> <tr><td style="width:50%;">Serie</td><td style="width:50%; text-align: right;">10.5</td></tr> <tr><td>Total</td><td style="text-align: right;">91.8</td></tr> </table>	1: 10.5x	→	Serie	10.5	Total	91.8	<p>6. Serie 1 Skud </p>  <table border="1" style="width:100%; border-collapse: collapse; margin-top: 10px;"> <tr><td style="width:50%;">1: 10.4</td><td style="width:50%; text-align: right;">←</td></tr> </table> <table border="1" style="width:100%; border-collapse: collapse; margin-top: 10px;"> <tr><td style="width:50%;">Serie</td><td style="width:50%; text-align: right;">10.4</td></tr> <tr><td>Total</td><td style="text-align: right;">102.2</td></tr> </table>	1: 10.4	←	Serie	10.4	Total	102.2								
1: 10.5x	→																				
Serie	10.5																				
Total	91.8																				
1: 10.4	←																				
Serie	10.4																				
Total	102.2																				
<p>7. Serie 1 Skud </p>  <table border="1" style="width:100%; border-collapse: collapse; margin-top: 10px;"> <tr><td style="width:50%;">1: 9.9</td><td style="width:50%; text-align: right;">→</td></tr> </table> <table border="1" style="width:100%; border-collapse: collapse; margin-top: 10px;"> <tr><td style="width:50%;">Serie</td><td style="width:50%; text-align: right;">9.9</td></tr> <tr><td>Total</td><td style="text-align: right;">112.1</td></tr> </table>	1: 9.9	→	Serie	9.9	Total	112.1															
1: 9.9	→																				
Serie	9.9																				
Total	112.1																				

Hold <b>25</b>	Skive <b>1</b>	<b>Erik Nissen</b>		
50m	Frederikssund Skytteforening, I		FBK	
10.08.2025	EM Finale 2025		Hanebjerg Skyttecenter	
Kommentar	Signatur			

1. Serie 5 Skud	1: 10.8x ↗ 2: 10.2 → 3: 10.4 ↘ 4: 10.8x ↘ 5: 10.2 ↓	2. Serie 1 Skud	1: 9.7 ↓																
	1: 9.7 ↓	4. Serie 1 Skud	1: 9.9 →																
	1: 10.2 ↘	6. Serie 1 Skud	1: 10.6x →																
	1: 10.3 →	8. Serie 1 Skud	1: 10.0 ↘																
<table border="1"> <tr><td>Serie</td><td>52.4</td></tr> <tr><td>Total</td><td>52.4</td></tr> </table>	Serie	52.4	Total	52.4	<table border="1"> <tr><td>Serie</td><td>9.7</td></tr> <tr><td>Total</td><td>62.1</td></tr> </table>	Serie	9.7	Total	62.1	<table border="1"> <tr><td>Serie</td><td>9.7</td></tr> <tr><td>Total</td><td>71.8</td></tr> </table>	Serie	9.7	Total	71.8	<table border="1"> <tr><td>Serie</td><td>9.9</td></tr> <tr><td>Total</td><td>81.7</td></tr> </table>	Serie	9.9	Total	81.7
Serie	52.4																		
Total	52.4																		
Serie	9.7																		
Total	62.1																		
Serie	9.7																		
Total	71.8																		
Serie	9.9																		
Total	81.7																		
<table border="1"> <tr><td>Serie</td><td>10.2</td></tr> <tr><td>Total</td><td>91.9</td></tr> </table>	Serie	10.2	Total	91.9	<table border="1"> <tr><td>Serie</td><td>10.6</td></tr> <tr><td>Total</td><td>102.5</td></tr> </table>	Serie	10.6	Total	102.5	<table border="1"> <tr><td>Serie</td><td>10.3</td></tr> <tr><td>Total</td><td>112.8</td></tr> </table>	Serie	10.3	Total	112.8	<table border="1"> <tr><td>Serie</td><td>10.0</td></tr> <tr><td>Total</td><td>122.8</td></tr> </table>	Serie	10.0	Total	122.8
Serie	10.2																		
Total	91.9																		
Serie	10.6																		
Total	102.5																		
Serie	10.3																		
Total	112.8																		
Serie	10.0																		
Total	122.8																		

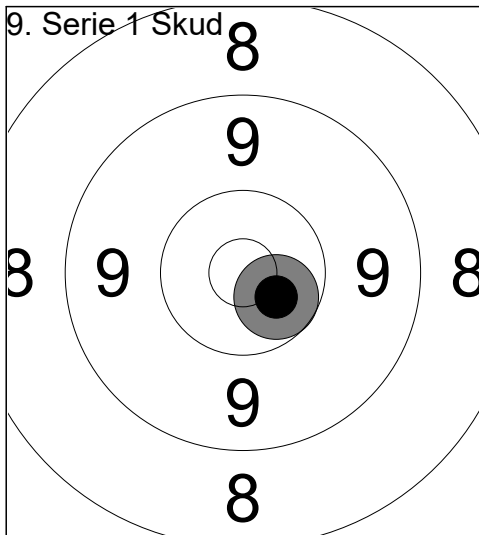

1: 10.6x ↘

Serie	10.6
Total	133.4

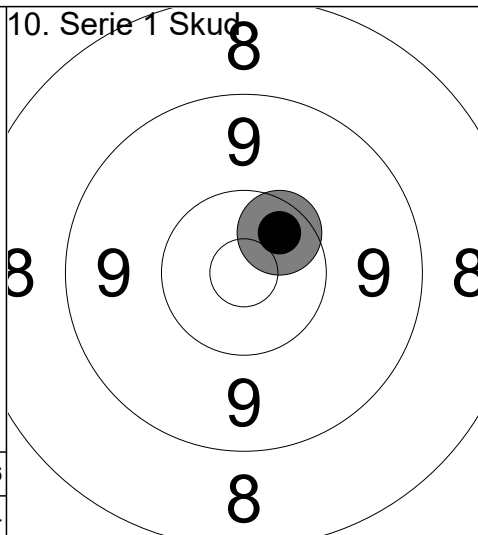

1: 10.4x ↗

Serie	10.4
Total	143.8

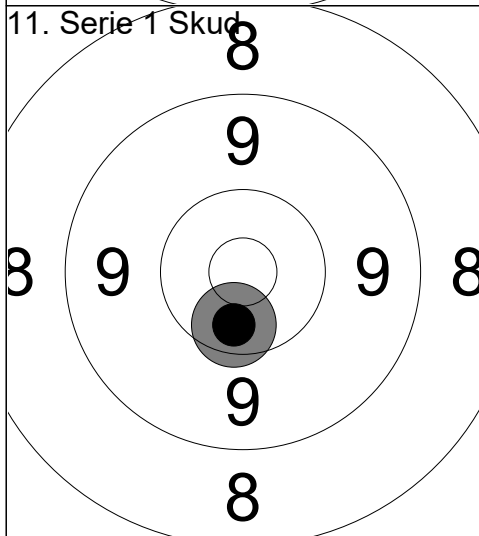

1: 10.4x ↓

Serie	10.4
Total	154.2

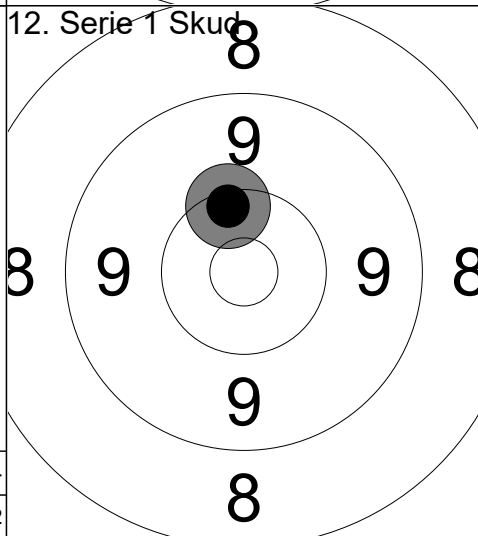

1: 10.3 ↑

Serie	10.3
Total	164.5

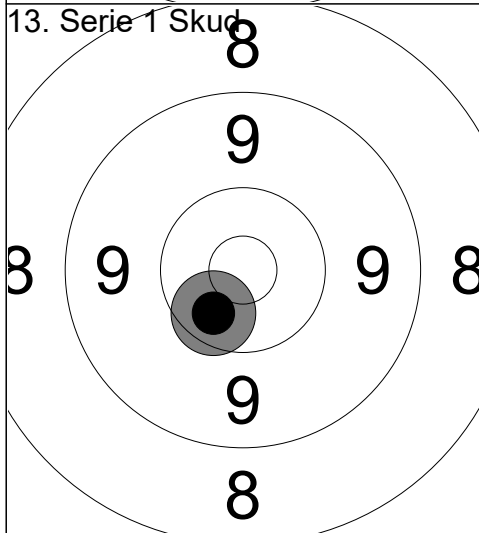

1: 10.4x ↙

Serie	10.4
Total	174.9

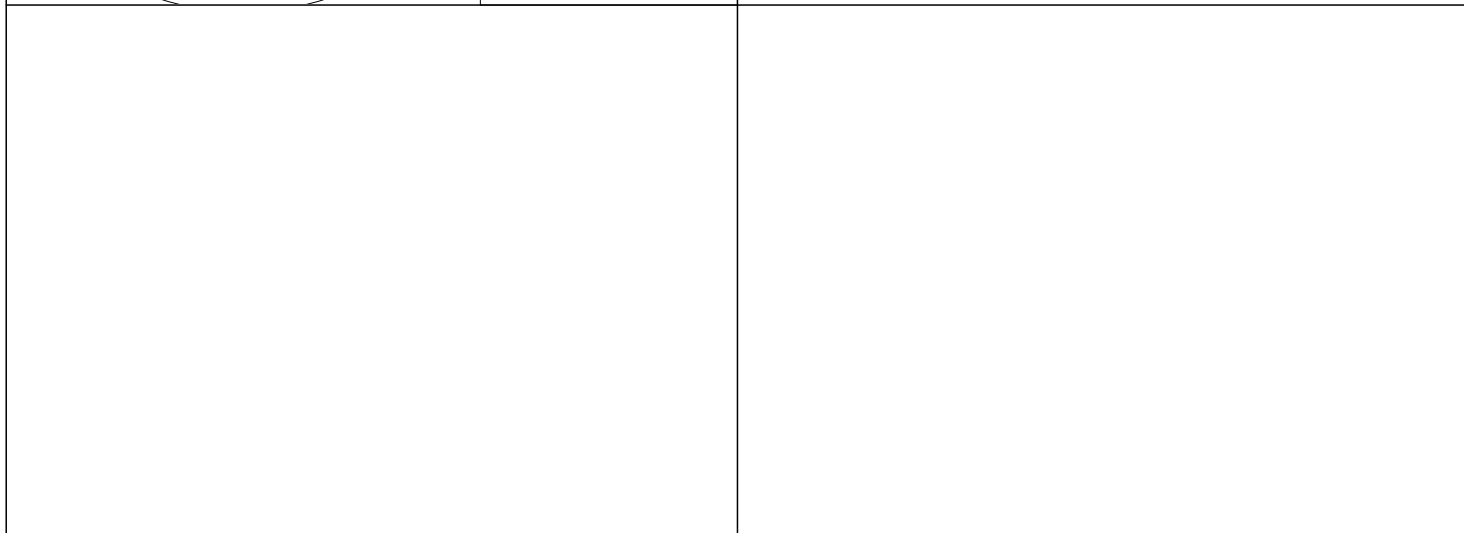

Hold <b>25</b>	Skive <b>2</b>	<b>Mathilde Maj Schou-Friis</b>	
50m	Frederikssund Skytteforening, I	FBK	
10.08.2025	EM Finale 2025	Hanebjerg Skyttecenter	
Kommentar	Signatur		

1. Serie 5 Skud	1: 9.3 ← 2: 10.7x ↓ 3: 10.8x ↓ 4: 10.7x ↗ 5: 10.4x ↓	2. Serie 1 Skud	1: 10.6x ↑								
	1: 10.3 ↓	4. Serie 1 Skud	1: 10.6x ↓								
	1: 10.1 ↓	6. Serie 1 Skud	1: 10.5x ←								
	1: 10.8x ↑	8. Serie 1 Skud	1: 9.9 ↓								
<table border="1"> <tr><td>Serie</td><td>51.9</td></tr> <tr><td>Total</td><td>51.9</td></tr> </table>	Serie	51.9	Total	51.9		<table border="1"> <tr><td>Serie</td><td>10.6</td></tr> <tr><td>Total</td><td>62.5</td></tr> </table>	Serie	10.6	Total	62.5	
Serie	51.9										
Total	51.9										
Serie	10.6										
Total	62.5										
		<table border="1"> <tr><td>Serie</td><td>10.6</td></tr> <tr><td>Total</td><td>83.4</td></tr> </table>	Serie	10.6	Total	83.4					
Serie	10.6										
Total	83.4										
		<table border="1"> <tr><td>Serie</td><td>10.5</td></tr> <tr><td>Total</td><td>104.0</td></tr> </table>	Serie	10.5	Total	104.0					
Serie	10.5										
Total	104.0										
		<table border="1"> <tr><td>Serie</td><td>9.9</td></tr> <tr><td>Total</td><td>124.7</td></tr> </table>	Serie	9.9	Total	124.7					
Serie	9.9										
Total	124.7										

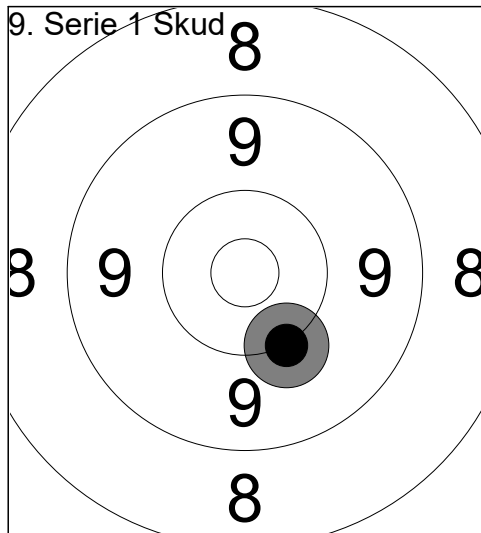

1: 10.1 ↘

Serie	10.1
Total	134.8

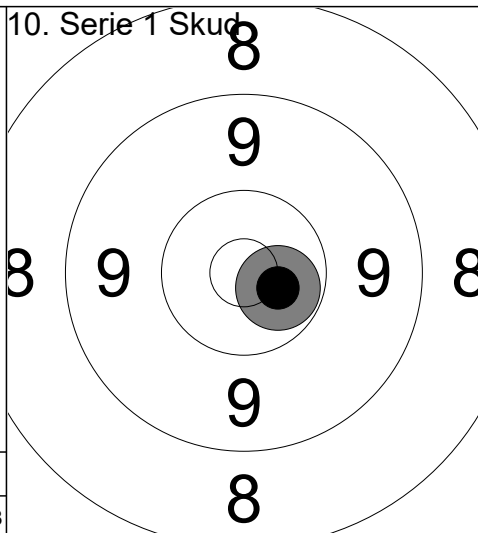

1: 10.6x ↗

Serie	10.6
Total	145.4

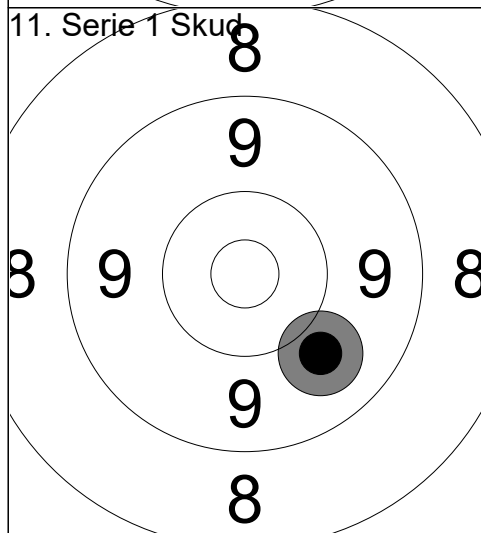

1: 9.9 ↘

Serie	9.9
Total	155.3

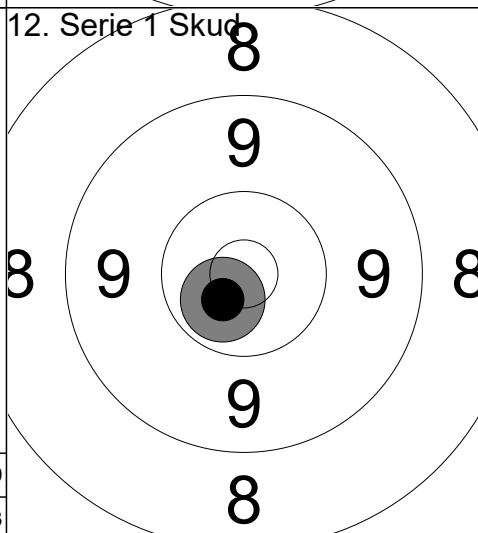

1: 10.6x ↙

Serie	10.6
Total	165.9

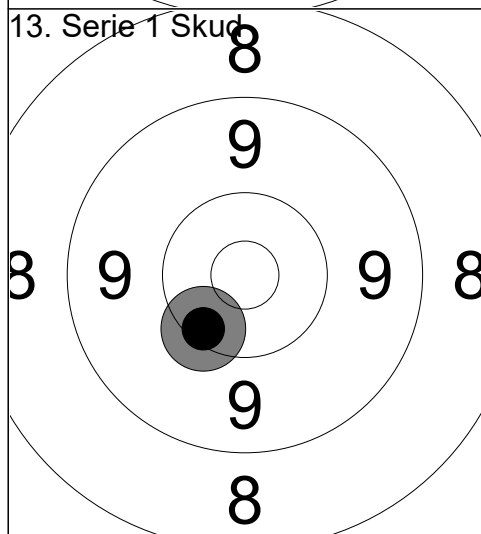

1: 10.3 ↙

Serie	10.3
Total	176.2

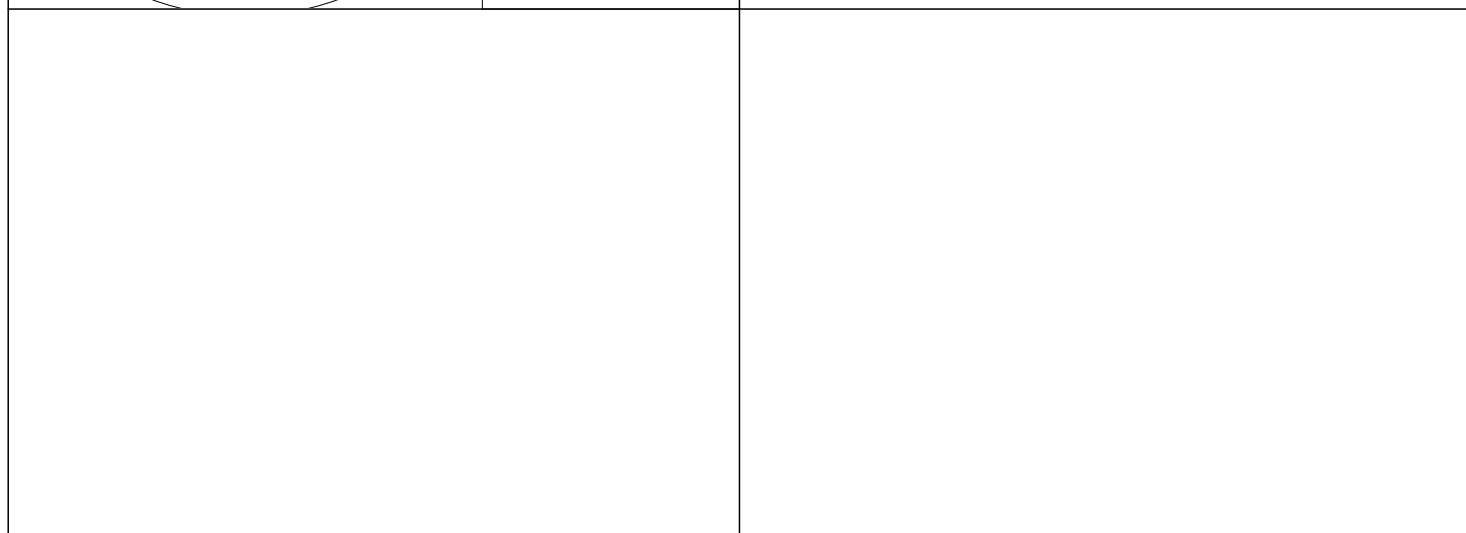

<p>1. Serie 5 Skud </p>	<p>1: 10.0 ↓ 2: 8.6 ↘ 3: 10.0 ↑ 4: 10.5x ← 5: 10.2 ↙</p> <table border="1" style="width:100%; border-collapse: collapse;"> <tr><td>Serie</td><td style="text-align: right;">49.3</td></tr> <tr><td>Total</td><td style="text-align: right;">49.3</td></tr> </table>	Serie	49.3	Total	49.3	<p>2. Serie 1 Skud </p> <p style="text-align: right;">1: 10.5x ↙</p> <table border="1" style="width:100%; border-collapse: collapse;"> <tr><td>Serie</td><td style="text-align: right;">10.5</td></tr> <tr><td>Total</td><td style="text-align: right;">59.8</td></tr> </table>	Serie	10.5	Total	59.8	
Serie	49.3										
Total	49.3										
Serie	10.5										
Total	59.8										
<p>3. Serie 1 Skud </p>	<p>1: 10.6x ↙</p> <table border="1" style="width:100%; border-collapse: collapse;"> <tr><td>Serie</td><td style="text-align: right;">10.6</td></tr> <tr><td>Total</td><td style="text-align: right;">70.4</td></tr> </table>	Serie	10.6	Total	70.4	<p>4. Serie 1 Skud </p> <p style="text-align: right;">1: 10.7x ↓</p> <table border="1" style="width:100%; border-collapse: collapse;"> <tr><td>Serie</td><td style="text-align: right;">10.7</td></tr> <tr><td>Total</td><td style="text-align: right;">81.1</td></tr> </table>	Serie	10.7	Total	81.1	
Serie	10.6										
Total	70.4										
Serie	10.7										
Total	81.1										
<p>5. Serie 1 Skud </p>	<p>1: 10.0 ↓</p> <table border="1" style="width:100%; border-collapse: collapse;"> <tr><td>Serie</td><td style="text-align: right;">10.0</td></tr> <tr><td>Total</td><td style="text-align: right;">91.1</td></tr> </table>	Serie	10.0	Total	91.1	<p>6. Serie 1 Skud </p> <p style="text-align: right;">1: 10.5x ↙</p> <table border="1" style="width:100%; border-collapse: collapse;"> <tr><td>Serie</td><td style="text-align: right;">10.5</td></tr> <tr><td>Total</td><td style="text-align: right;">101.6</td></tr> </table>	Serie	10.5	Total	101.6	
Serie	10.0										
Total	91.1										
Serie	10.5										
Total	101.6										
<p>7. Serie 1 Skud </p>	<p>1: 9.1 ↓</p> <table border="1" style="width:100%; border-collapse: collapse;"> <tr><td>Serie</td><td style="text-align: right;">9.1</td></tr> <tr><td>Total</td><td style="text-align: right;">110.7</td></tr> </table>	Serie	9.1	Total	110.7	<p>8. Serie 1 Skud </p> <p style="text-align: right;">1: 10.0 ←</p> <table border="1" style="width:100%; border-collapse: collapse;"> <tr><td>Serie</td><td style="text-align: right;">10.0</td></tr> <tr><td>Total</td><td style="text-align: right;">120.7</td></tr> </table>	Serie	10.0	Total	120.7	
Serie	9.1										
Total	110.7										
Serie	10.0										
Total	120.7										
<p>9. Serie 1 Skud </p>	<p>1: 10.2 ↓</p> <table border="1" style="width:100%; border-collapse: collapse;"> <tr><td>Serie</td><td style="text-align: right;">10.2</td></tr> <tr><td>Total</td><td style="text-align: right;">130.9</td></tr> </table>	Serie	10.2	Total	130.9						
Serie	10.2										
Total	130.9										

Hold <b>25</b>	Skive <b>4</b>	<b>Emmily Brendstrup</b>	
50m	Ganløse Skytteforening		FBK
10.08.2025	EM Finale 2025		Hanebjerg Skyttecenter
Kommentar	Signatur		

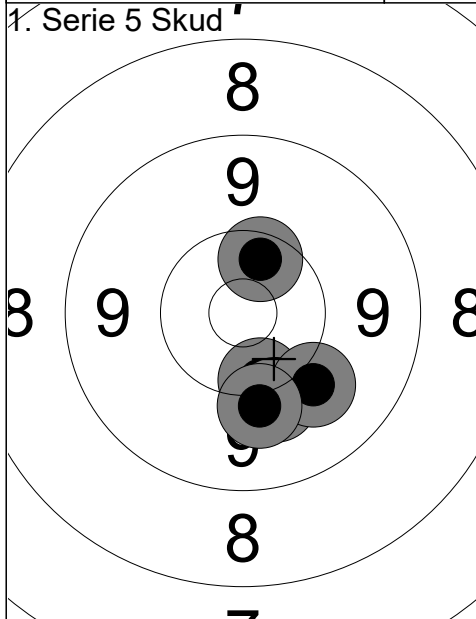

1:	10.3	↓
2:	10.4	↗
3:	10.1	↓
4:	10.0	↓
5:	10.0	↓
Serie		50.8
Total		50.8

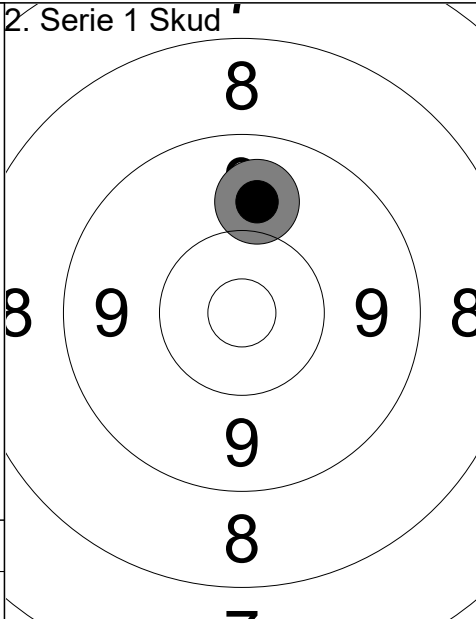

1:	9.9	↑
Serie		9.9
Total		60.7

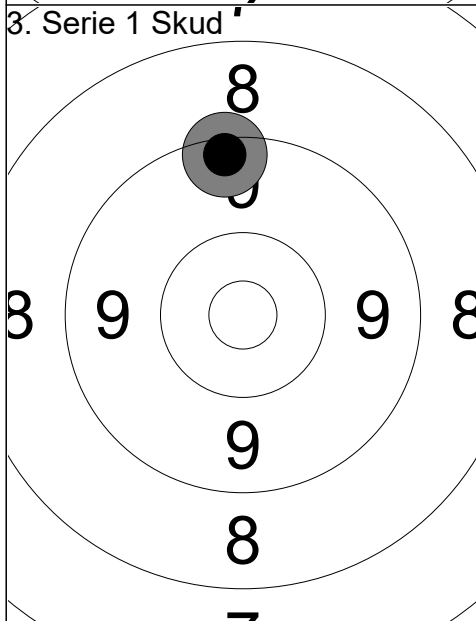

1:	9.3	↑
Serie		9.3
Total		70.0

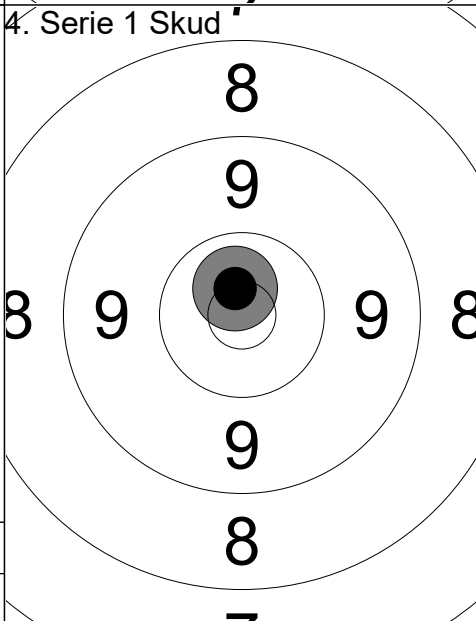

1:	10.7x	↑
Serie		10.7
Total		80.7

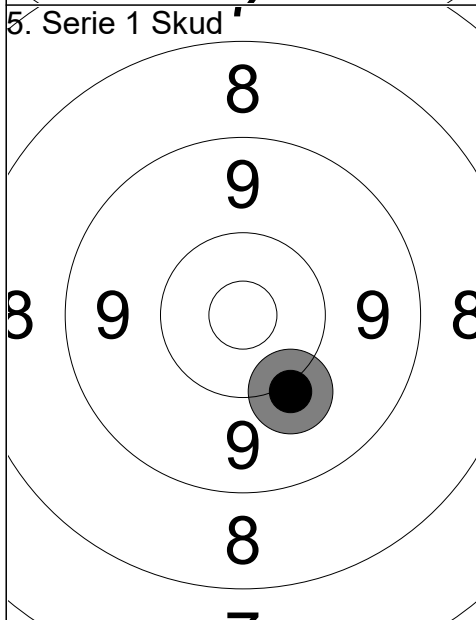

1:	10.1	↓
Serie		10.1
Total		90.8

<p>1. Serie 5 Skud </p>	<p>1: 9.6 2: 10.3 3: 10.9x 4: 10.6x 5: 9.8</p>	<p>2. Serie 1 Skud </p>	<p>1: 10.4</p>								
	<table border="1" style="width:100%; border-collapse: collapse;"> <tr><td style="width:80%;">Serie</td><td style="text-align: right;">51.2</td></tr> <tr><td>Total</td><td style="text-align: right;">51.2</td></tr> </table>	Serie	51.2	Total	51.2		<table border="1" style="width:100%; border-collapse: collapse;"> <tr><td style="width:80%;">Serie</td><td style="text-align: right;">10.4</td></tr> <tr><td>Total</td><td style="text-align: right;">61.6</td></tr> </table>	Serie	10.4	Total	61.6
Serie	51.2										
Total	51.2										
Serie	10.4										
Total	61.6										
<p>3. Serie 1 Skud </p>	<p>1: 10.2</p>	<p>4. Serie 1 Skud </p>	<p>1: 10.3</p>								
	<table border="1" style="width:100%; border-collapse: collapse;"> <tr><td style="width:80%;">Serie</td><td style="text-align: right;">10.2</td></tr> <tr><td>Total</td><td style="text-align: right;">71.8</td></tr> </table>	Serie	10.2	Total	71.8		<table border="1" style="width:100%; border-collapse: collapse;"> <tr><td style="width:80%;">Serie</td><td style="text-align: right;">10.3</td></tr> <tr><td>Total</td><td style="text-align: right;">82.1</td></tr> </table>	Serie	10.3	Total	82.1
Serie	10.2										
Total	71.8										
Serie	10.3										
Total	82.1										
<p>5. Serie 1 Skud </p>	<p>1: 9.1</p>	<p>6. Serie 1 Skud </p>	<p>1: 10.1</p>								
	<table border="1" style="width:100%; border-collapse: collapse;"> <tr><td style="width:80%;">Serie</td><td style="text-align: right;">9.1</td></tr> <tr><td>Total</td><td style="text-align: right;">91.2</td></tr> </table>	Serie	9.1	Total	91.2		<table border="1" style="width:100%; border-collapse: collapse;"> <tr><td style="width:80%;">Serie</td><td style="text-align: right;">10.1</td></tr> <tr><td>Total</td><td style="text-align: right;">101.3</td></tr> </table>	Serie	10.1	Total	101.3
Serie	9.1										
Total	91.2										
Serie	10.1										
Total	101.3										
<p>7. Serie 1 Skud </p>	<p>1: 10.0</p>	<p>8. Serie 1 Skud </p>	<p>1: 10.5x</p>								
	<table border="1" style="width:100%; border-collapse: collapse;"> <tr><td style="width:80%;">Serie</td><td style="text-align: right;">10.0</td></tr> <tr><td>Total</td><td style="text-align: right;">111.3</td></tr> </table>	Serie	10.0	Total	111.3		<table border="1" style="width:100%; border-collapse: collapse;"> <tr><td style="width:80%;">Serie</td><td style="text-align: right;">10.5</td></tr> <tr><td>Total</td><td style="text-align: right;">121.8</td></tr> </table>	Serie	10.5	Total	121.8
Serie	10.0										
Total	111.3										
Serie	10.5										
Total	121.8										
<p>9. Serie 1 Skud </p>	<p>1: 10.3</p>	<p>10. Serie 1 Skud </p>	<p>1: 10.3</p>								
	<table border="1" style="width:100%; border-collapse: collapse;"> <tr><td style="width:80%;">Serie</td><td style="text-align: right;">10.3</td></tr> <tr><td>Total</td><td style="text-align: right;">132.1</td></tr> </table>	Serie	10.3	Total	132.1		<table border="1" style="width:100%; border-collapse: collapse;"> <tr><td style="width:80%;">Serie</td><td style="text-align: right;">10.3</td></tr> <tr><td>Total</td><td style="text-align: right;">142.4</td></tr> </table>	Serie	10.3	Total	142.4
Serie	10.3										
Total	132.1										
Serie	10.3										
Total	142.4										
<p>11. Serie 1 Skud </p>	<p>1: 9.4</p>										
	<table border="1" style="width:100%; border-collapse: collapse;"> <tr><td style="width:80%;">Serie</td><td style="text-align: right;">9.4</td></tr> <tr><td>Total</td><td style="text-align: right;">151.8</td></tr> </table>	Serie	9.4	Total	151.8						
Serie	9.4										
Total	151.8										

Hold <b>25</b>	Skive <b>6</b>	<b>Villads Jespersen</b>
-------------------	-------------------	--------------------------

50m	Kreds 57, Ferslev, Skibby	FBK	
-----	---------------------------	-----	--

10.08.2025	EM Finale 2025	Hanebjerg Skyttecenter
------------	----------------	------------------------

Kommentar	Signatur
-----------	----------

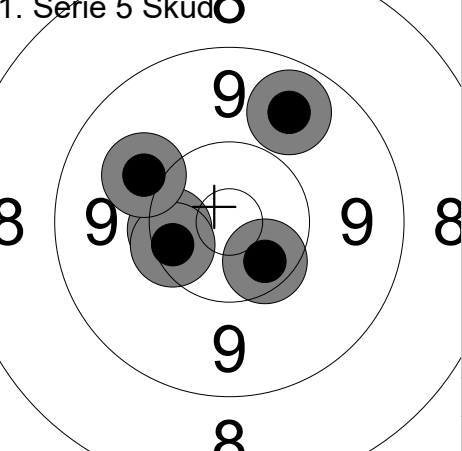
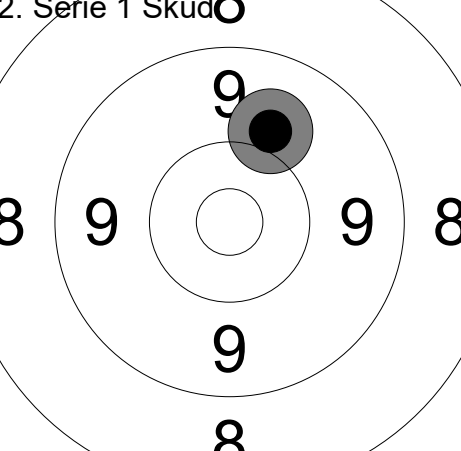
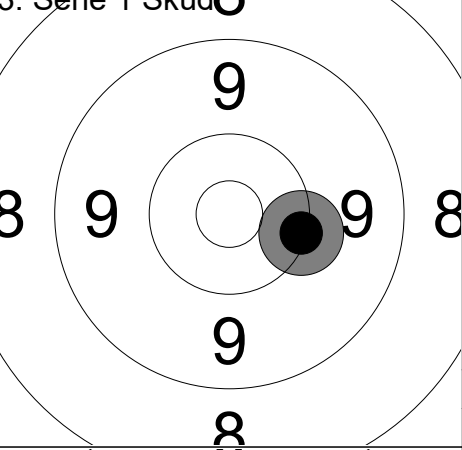
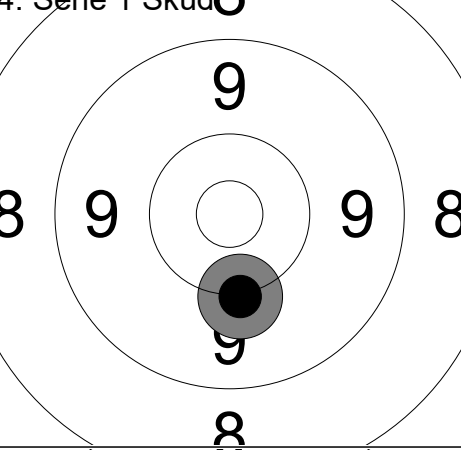
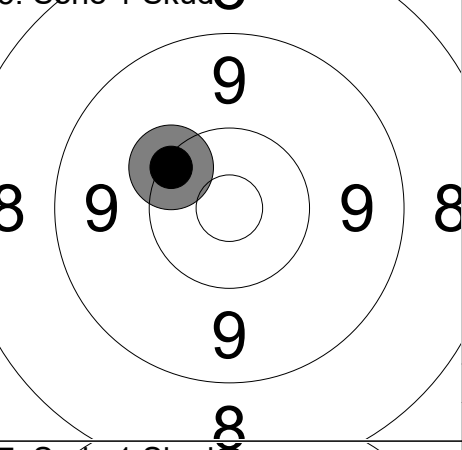
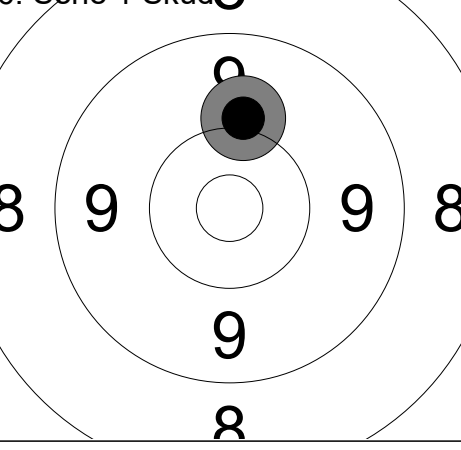
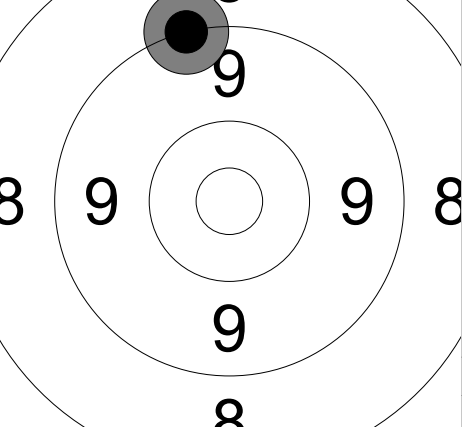
<p>1. Serie 5 Skud </p>  <table border="1" style="width:100%; margin-top: 10px;"> <tr><td>Serie</td><td style="text-align: right;">50.8</td></tr> <tr><td>Total</td><td style="text-align: right;">50.8</td></tr> </table>	Serie	50.8	Total	50.8	<p>2. Serie 1 Skud </p>  <table border="1" style="width:100%; margin-top: 10px;"> <tr><td>Serie</td><td style="text-align: right;">10.0</td></tr> <tr><td>Total</td><td style="text-align: right;">60.8</td></tr> </table>	Serie	10.0	Total	60.8	<p>1: 10.4 ←</p> <p>2: 10.4x ↓</p> <p>3: 10.3 ←</p> <p>4: 10.0 ↖</p> <p>5: 9.7 ↗</p>
Serie	50.8									
Total	50.8									
Serie	10.0									
Total	60.8									
<p>3. Serie 1 Skud </p>  <table border="1" style="width:100%; margin-top: 10px;"> <tr><td>Serie</td><td style="text-align: right;">10.2</td></tr> <tr><td>Total</td><td style="text-align: right;">71.0</td></tr> </table>	Serie	10.2	Total	71.0	<p>4. Serie 1 Skud </p>  <table border="1" style="width:100%; margin-top: 10px;"> <tr><td>Serie</td><td style="text-align: right;">10.1</td></tr> <tr><td>Total</td><td style="text-align: right;">81.1</td></tr> </table>	Serie	10.1	Total	81.1	<p>1: 10.2 →</p>
Serie	10.2									
Total	71.0									
Serie	10.1									
Total	81.1									
<p>5. Serie 1 Skud </p>  <table border="1" style="width:100%; margin-top: 10px;"> <tr><td>Serie</td><td style="text-align: right;">10.3</td></tr> <tr><td>Total</td><td style="text-align: right;">91.4</td></tr> </table>	Serie	10.3	Total	91.4	<p>6. Serie 1 Skud </p>  <table border="1" style="width:100%; margin-top: 10px;"> <tr><td>Serie</td><td style="text-align: right;">10.1</td></tr> <tr><td>Total</td><td style="text-align: right;">101.5</td></tr> </table>	Serie	10.1	Total	101.5	<p>1: 10.3 ↖</p>
Serie	10.3									
Total	91.4									
Serie	10.1									
Total	101.5									
<p>7. Serie 1 Skud </p>  <table border="1" style="width:100%; margin-top: 10px;"> <tr><td>Serie</td><td style="text-align: right;">9.2</td></tr> <tr><td>Total</td><td style="text-align: right;">110.7</td></tr> </table>	Serie	9.2	Total	110.7		<p>1: 9.2 ↗</p>				
Serie	9.2									
Total	110.7									

<p>1. Serie 5 Skud </p> <table border="1" style="width:100%; border-collapse: collapse; margin-top: 10px;"> <tr><td>Serie</td><td style="text-align: right;">50.7</td></tr> <tr><td>Total</td><td style="text-align: right;">50.7</td></tr> </table>	Serie	50.7	Total	50.7	<p>2. Serie 1 Skud </p> <p>1: 9.5 →</p> <table border="1" style="width:100%; border-collapse: collapse; margin-top: 10px;"> <tr><td>Serie</td><td style="text-align: right;">9.5</td></tr> <tr><td>Total</td><td style="text-align: right;">60.2</td></tr> </table>	Serie	9.5	Total	60.2
Serie	50.7								
Total	50.7								
Serie	9.5								
Total	60.2								
<p>3. Serie 1 Skud </p> <table border="1" style="width:100%; border-collapse: collapse; margin-top: 10px;"> <tr><td>Serie</td><td style="text-align: right;">10.8</td></tr> <tr><td>Total</td><td style="text-align: right;">71.0</td></tr> </table>	Serie	10.8	Total	71.0	<p>4. Serie 1 Skud </p> <p>1: 9.8 ↖</p> <table border="1" style="width:100%; border-collapse: collapse; margin-top: 10px;"> <tr><td>Serie</td><td style="text-align: right;">9.8</td></tr> <tr><td>Total</td><td style="text-align: right;">80.8</td></tr> </table>	Serie	9.8	Total	80.8
Serie	10.8								
Total	71.0								
Serie	9.8								
Total	80.8								
<p>5. Serie 1 Skud </p> <table border="1" style="width:100%; border-collapse: collapse; margin-top: 10px;"> <tr><td>Serie</td><td style="text-align: right;">9.3</td></tr> <tr><td>Total</td><td style="text-align: right;">90.1</td></tr> </table>	Serie	9.3	Total	90.1	<p>6. Serie 1 Skud </p> <p>1: 9.7 ↖</p> <table border="1" style="width:100%; border-collapse: collapse; margin-top: 10px;"> <tr><td>Serie</td><td style="text-align: right;">9.7</td></tr> <tr><td>Total</td><td style="text-align: right;">99.8</td></tr> </table>	Serie	9.7	Total	99.8
Serie	9.3								
Total	90.1								
Serie	9.7								
Total	99.8								
<p>7. Serie 1 Skud </p> <table border="1" style="width:100%; border-collapse: collapse; margin-top: 10px;"> <tr><td>Serie</td><td style="text-align: right;">10.1</td></tr> <tr><td>Total</td><td style="text-align: right;">109.9</td></tr> </table>	Serie	10.1	Total	109.9	<p>8. Serie 1 Skud </p> <p>1: 9.1 ↖</p> <table border="1" style="width:100%; border-collapse: collapse; margin-top: 10px;"> <tr><td>Serie</td><td style="text-align: right;">9.1</td></tr> <tr><td>Total</td><td style="text-align: right;">119.0</td></tr> </table>	Serie	9.1	Total	119.0
Serie	10.1								
Total	109.9								
Serie	9.1								
Total	119.0								

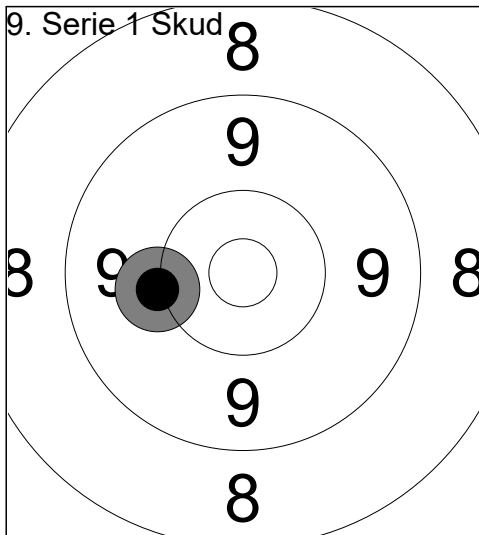

1: 10.1 ←

Serie	10.1
Total	129.1

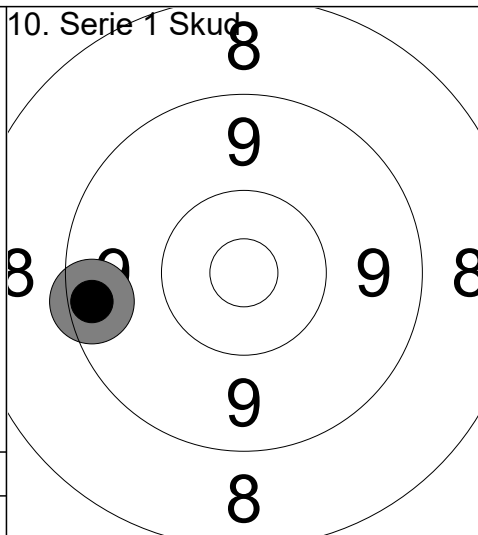

1: 9.4 ←

Serie	9.4
Total	138.5

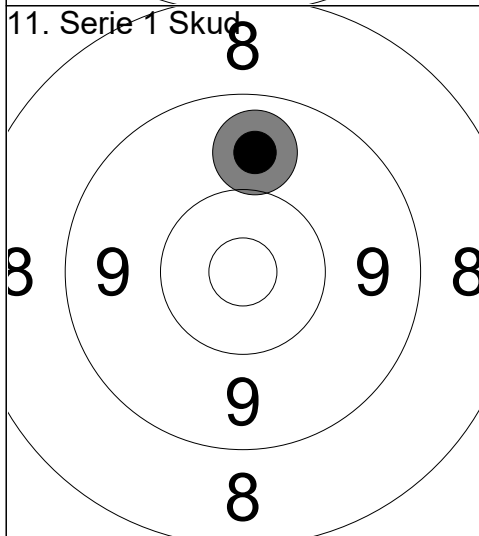

1: 9.8 ↑

Serie	9.8
Total	148.3

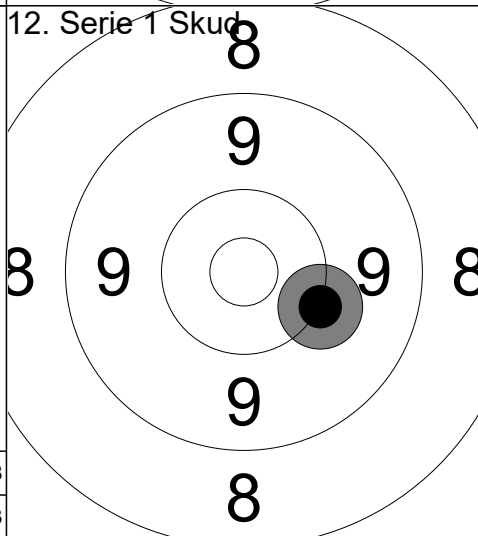

1: 10.1 →

Serie	10.1
Total	158.4

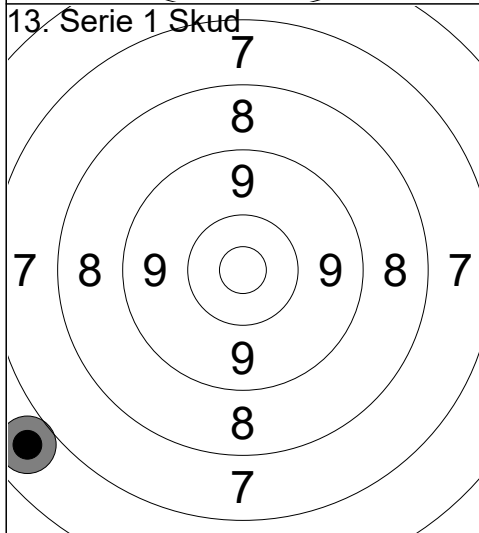

1: 6.8 ↙

Serie	6.8
Total	165.2

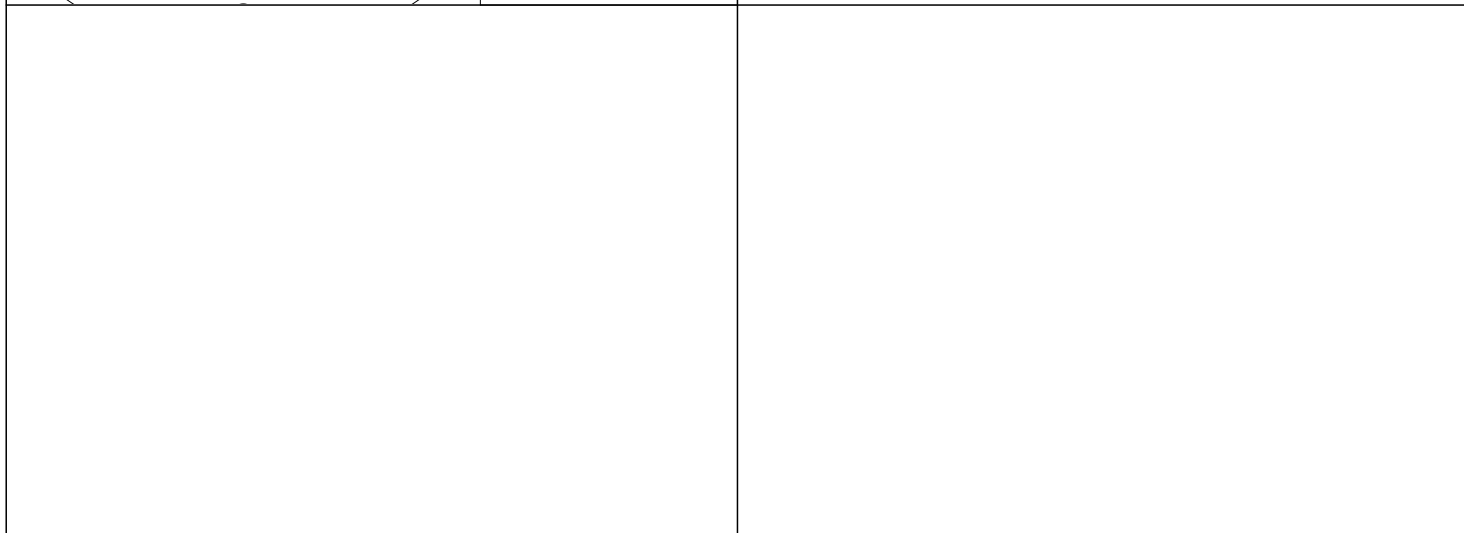

<p>1. Serie 5 Skud</p> <table border="1" style="width:100%; border-collapse: collapse;"> <tr><td>Serie</td><td style="text-align: right;">47.5</td></tr> <tr><td>Total</td><td style="text-align: right;">47.5</td></tr> </table>	Serie	47.5	Total	47.5	<p>1: 9.0 ← 2: 10.7x ← 3: 9.4 ↗ 4: 8.4 ← 5: 10.0 ↑</p>	<p>2. Serie 1 Skud</p> <table border="1" style="width:100%; border-collapse: collapse;"> <tr><td>Serie</td><td style="text-align: right;">10.7</td></tr> <tr><td>Total</td><td style="text-align: right;">58.2</td></tr> </table>	Serie	10.7	Total	58.2	<p>1: 10.7x ↑</p>
Serie	47.5										
Total	47.5										
Serie	10.7										
Total	58.2										
<p>3. Serie 1 Skud</p> <table border="1" style="width:100%; border-collapse: collapse;"> <tr><td>Serie</td><td style="text-align: right;">9.0</td></tr> <tr><td>Total</td><td style="text-align: right;">67.2</td></tr> </table>	Serie	9.0	Total	67.2	<p>1: 9.0 ←</p>	<p>4. Serie 1 Skud</p> <table border="1" style="width:100%; border-collapse: collapse;"> <tr><td>Serie</td><td style="text-align: right;">8.9</td></tr> <tr><td>Total</td><td style="text-align: right;">76.1</td></tr> </table>	Serie	8.9	Total	76.1	<p>1: 8.9 →</p>
Serie	9.0										
Total	67.2										
Serie	8.9										
Total	76.1										
<p>5. Serie 1 Skud</p> <table border="1" style="width:100%; border-collapse: collapse;"> <tr><td>Serie</td><td style="text-align: right;">9.8</td></tr> <tr><td>Total</td><td style="text-align: right;">85.9</td></tr> </table>	Serie	9.8	Total	85.9	<p>1: 9.8 ←</p>	<p>6. Serie 1 Skud</p> <table border="1" style="width:100%; border-collapse: collapse;"> <tr><td>Serie</td><td style="text-align: right;">9.2</td></tr> <tr><td>Total</td><td style="text-align: right;">95.1</td></tr> </table>	Serie	9.2	Total	95.1	<p>1: 9.2 ↖</p>
Serie	9.8										
Total	85.9										
Serie	9.2										
Total	95.1										
<p>7. Serie 1 Skud</p> <table border="1" style="width:100%; border-collapse: collapse;"> <tr><td>Serie</td><td style="text-align: right;">9.6</td></tr> <tr><td>Total</td><td style="text-align: right;">104.7</td></tr> </table>	Serie	9.6	Total	104.7	<p>1: 9.6 ↓</p>	<p>8. Serie 1 Skud</p> <table border="1" style="width:100%; border-collapse: collapse;"> <tr><td>Serie</td><td style="text-align: right;">9.4</td></tr> <tr><td>Total</td><td style="text-align: right;">114.1</td></tr> </table>	Serie	9.4	Total	114.1	<p>1: 9.4 ↑</p>
Serie	9.6										
Total	104.7										
Serie	9.4										
Total	114.1										
<p>9. Serie 1 Skud</p> <table border="1" style="width:100%; border-collapse: collapse;"> <tr><td>Serie</td><td style="text-align: right;">10.2</td></tr> <tr><td>Total</td><td style="text-align: right;">124.3</td></tr> </table>	Serie	10.2	Total	124.3	<p>1: 10.2 ↙</p>	<p>10. Serie 1 Skud</p> <table border="1" style="width:100%; border-collapse: collapse;"> <tr><td>Serie</td><td style="text-align: right;">10.0</td></tr> <tr><td>Total</td><td style="text-align: right;">134.3</td></tr> </table>	Serie	10.0	Total	134.3	<p>1: 10.0 →</p>
Serie	10.2										
Total	124.3										
Serie	10.0										
Total	134.3										
<p>11. Serie 1 Skud</p> <table border="1" style="width:100%; border-collapse: collapse;"> <tr><td>Serie</td><td style="text-align: right;">10.0</td></tr> <tr><td>Total</td><td style="text-align: right;">144.3</td></tr> </table>	Serie	10.0	Total	144.3	<p>1: 10.0 ↓</p>						
Serie	10.0										
Total	144.3										

Hold <b>25</b>	Skive <b>9</b>	<b>Kim Noerager Bay</b>	
50m	Egedal Skytteforening	FST	
10.08.2025	EM Finale 2025	Hanebjerg Skyttecenter	
Kommentar	Signatur		

1. Serie 5 Skud	1: 10.8x ↗ 2: 10.6x ↑ 3: 10.0 ↖ 4: 9.8 ↖ 5: 9.1 →	2. Serie 1 Skud	1: 8.8 →
3. Serie 1 Skud	1: 9.4 ↘	4. Serie 1 Skud	1: 9.6 ↖
5. Serie 1 Skud	1: 10.0 ↖	6. Serie 1 Skud	1: 9.2 ↖
7. Serie 1 Skud	1: 9.1 ↑	8. Serie 1 Skud	1: 9.8 ←

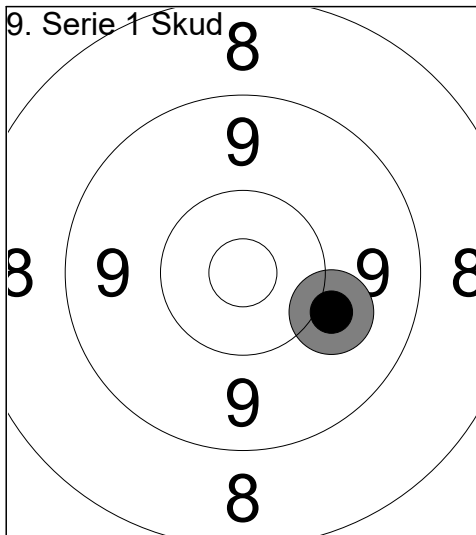

1: 10.0 ↘

Serie	10.0
Total	126.2

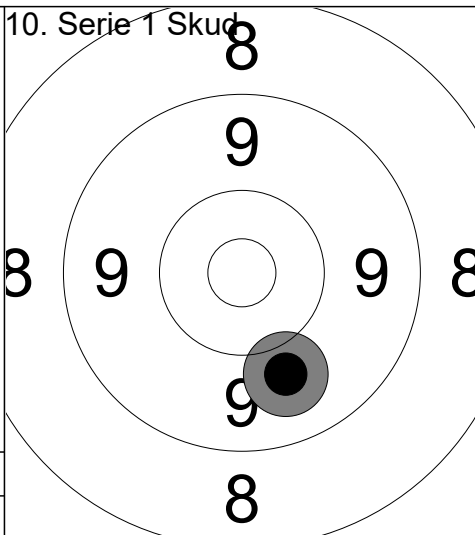

1: 9.9 ↘

Serie	9.9
Total	136.1

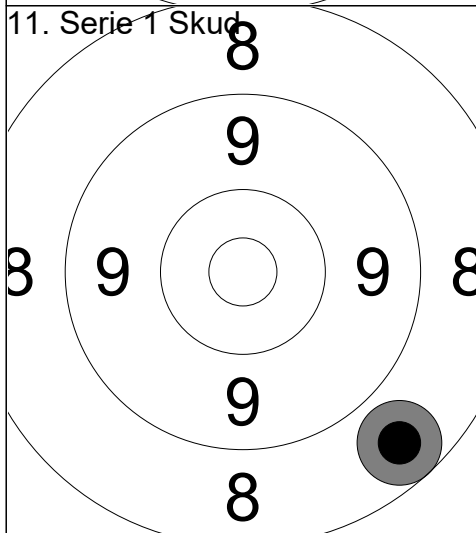

1: 8.6 ↘

Serie	8.6
Total	144.7

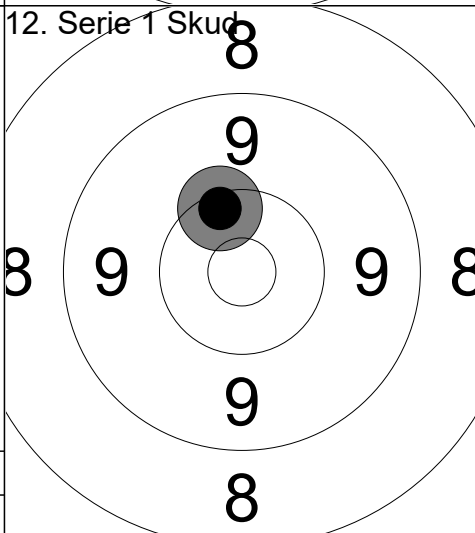

1: 10.3 ↗

Serie	10.3
Total	155.0

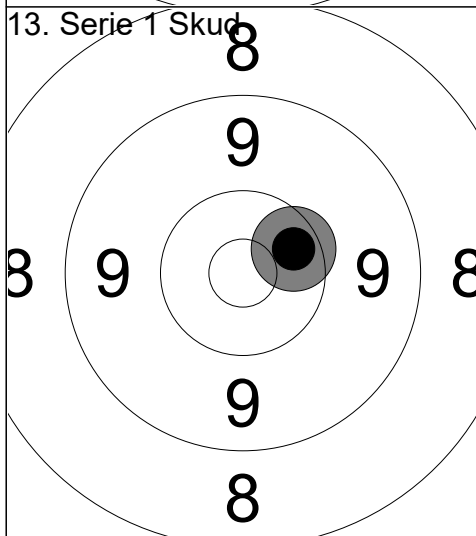

1: 10.4 ↗

Serie	10.4
Total	165.4

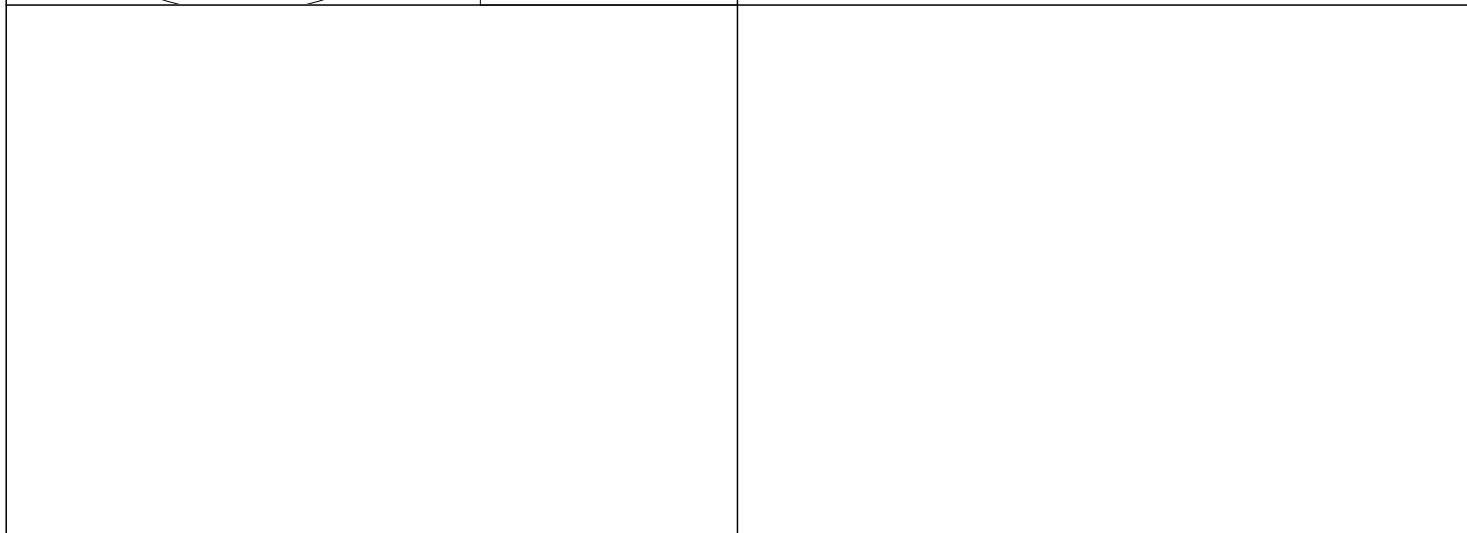

Hold <b>25</b>	Skive <b>10</b>	<b>Freya Kofoed</b>
-------------------	--------------------	---------------------

50m	Østerlars Skytteforening	FST	
-----	--------------------------	-----	--

10.08.2025	EM Finale 2025	Hanebjerg Skyttecenter
------------	----------------	------------------------

Kommentar	Signatur
-----------	----------

<p>1. Serie 5 Skud</p> <table border="1" style="width:100%; border-collapse: collapse;"> <tr><td>1:</td><td>9.1</td><td style="text-align: right;">↙</td></tr> <tr><td>2:</td><td>10.5x</td><td style="text-align: right;">↘</td></tr> <tr><td>3:</td><td>10.4</td><td style="text-align: right;">↘</td></tr> <tr><td>4:</td><td>9.8</td><td style="text-align: right;">↘</td></tr> <tr><td>5:</td><td>9.0</td><td style="text-align: right;">↘</td></tr> <tr><td colspan="2">Serie</td><td style="text-align: right;">48.8</td></tr> <tr><td colspan="2">Total</td><td style="text-align: right;">48.8</td></tr> </table>	1:	9.1	↙	2:	10.5x	↘	3:	10.4	↘	4:	9.8	↘	5:	9.0	↘	Serie		48.8	Total		48.8	<p>2. Serie 1 Skud</p> <table border="1" style="width:100%; border-collapse: collapse;"> <tr><td>1:</td><td>9.0</td><td style="text-align: right;">↗</td></tr> <tr><td colspan="2">Serie</td><td style="text-align: right;">9.0</td></tr> <tr><td colspan="2">Total</td><td style="text-align: right;">57.8</td></tr> </table>	1:	9.0	↗	Serie		9.0	Total		57.8	
1:	9.1	↙																														
2:	10.5x	↘																														
3:	10.4	↘																														
4:	9.8	↘																														
5:	9.0	↘																														
Serie		48.8																														
Total		48.8																														
1:	9.0	↗																														
Serie		9.0																														
Total		57.8																														
<p>3. Serie 1 Skud</p> <table border="1" style="width:100%; border-collapse: collapse;"> <tr><td>1:</td><td>8.4</td><td style="text-align: right;">↙</td></tr> <tr><td colspan="2">Serie</td><td style="text-align: right;">8.4</td></tr> <tr><td colspan="2">Total</td><td style="text-align: right;">66.2</td></tr> </table>	1:	8.4	↙	Serie		8.4	Total		66.2	<p>4. Serie 1 Skud</p> <table border="1" style="width:100%; border-collapse: collapse;"> <tr><td>1:</td><td>9.4</td><td style="text-align: right;">↑</td></tr> <tr><td colspan="2">Serie</td><td style="text-align: right;">9.4</td></tr> <tr><td colspan="2">Total</td><td style="text-align: right;">75.6</td></tr> </table>	1:	9.4	↑	Serie		9.4	Total		75.6													
1:	8.4	↙																														
Serie		8.4																														
Total		66.2																														
1:	9.4	↑																														
Serie		9.4																														
Total		75.6																														
<p>5. Serie 1 Skud</p> <table border="1" style="width:100%; border-collapse: collapse;"> <tr><td>1:</td><td>9.3</td><td style="text-align: right;">→</td></tr> <tr><td colspan="2">Serie</td><td style="text-align: right;">9.3</td></tr> <tr><td colspan="2">Total</td><td style="text-align: right;">84.9</td></tr> </table>	1:	9.3	→	Serie		9.3	Total		84.9	<p>6. Serie 1 Skud</p> <table border="1" style="width:100%; border-collapse: collapse;"> <tr><td>1:</td><td>9.3</td><td style="text-align: right;">↖</td></tr> <tr><td colspan="2">Serie</td><td style="text-align: right;">9.3</td></tr> <tr><td colspan="2">Total</td><td style="text-align: right;">94.2</td></tr> </table>	1:	9.3	↖	Serie		9.3	Total		94.2													
1:	9.3	→																														
Serie		9.3																														
Total		84.9																														
1:	9.3	↖																														
Serie		9.3																														
Total		94.2																														
<p>7. Serie 1 Skud</p> <table border="1" style="width:100%; border-collapse: collapse;"> <tr><td>1:</td><td>8.8</td><td style="text-align: right;">↑</td></tr> <tr><td colspan="2">Serie</td><td style="text-align: right;">8.8</td></tr> <tr><td colspan="2">Total</td><td style="text-align: right;">103.0</td></tr> </table>	1:	8.8	↑	Serie		8.8	Total		103.0	<p>8. Serie 1 Skud</p> <table border="1" style="width:100%; border-collapse: collapse;"> <tr><td>1:</td><td>10.5x</td><td style="text-align: right;">↙</td></tr> <tr><td colspan="2">Serie</td><td style="text-align: right;">10.5</td></tr> <tr><td colspan="2">Total</td><td style="text-align: right;">113.5</td></tr> </table>	1:	10.5x	↙	Serie		10.5	Total		113.5													
1:	8.8	↑																														
Serie		8.8																														
Total		103.0																														
1:	10.5x	↙																														
Serie		10.5																														
Total		113.5																														
<p>9. Serie 1 Skud</p> <table border="1" style="width:100%; border-collapse: collapse;"> <tr><td>1:</td><td>9.7</td><td style="text-align: right;">↑</td></tr> <tr><td colspan="2">Serie</td><td style="text-align: right;">9.7</td></tr> <tr><td colspan="2">Total</td><td style="text-align: right;">123.2</td></tr> </table>	1:	9.7	↑	Serie		9.7	Total		123.2																							
1:	9.7	↑																														
Serie		9.7																														
Total		123.2																														

Hold <b>25</b>	Skive <b>11</b>	<b>Martin Schou-Friis</b>	
50m		Dauglykke Skytteforening	FST
10.08.2025		EM Finale 2025	Hanebjerg Skyttecenter
Kommentar		Signatur	

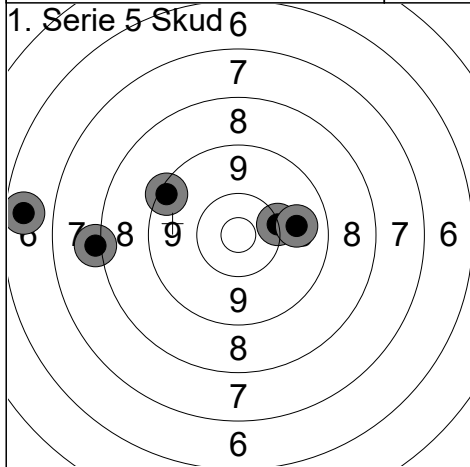

1:	10.2	→
2:	9.8	→
3:	6.6	←
4:	9.3	↗
5:	8.1	←

Serie	44.0
Total	44.0

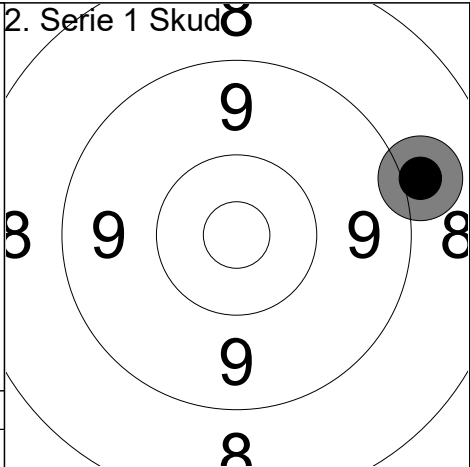

1:	9.0	→
----	-----	---

Serie	9.0
Total	53.0

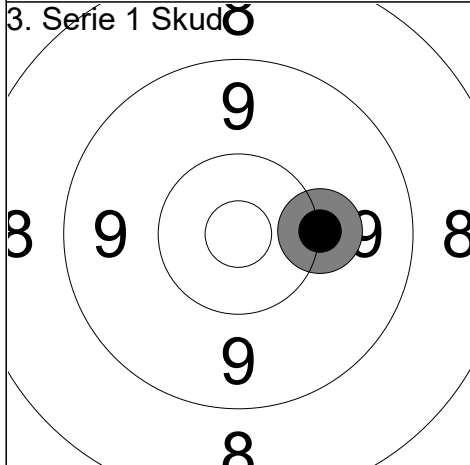

1:	10.1	→
----	------	---

Serie	10.1
Total	63.1

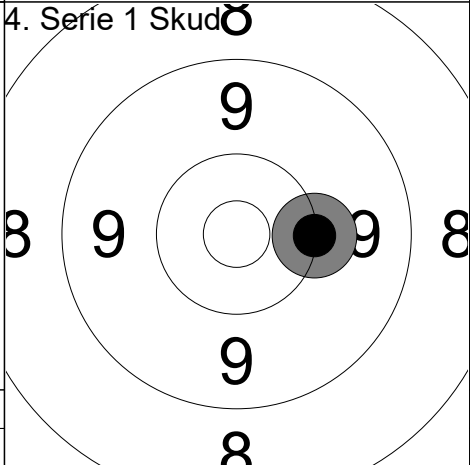

1:	10.2	→
----	------	---

Serie	10.2
Total	73.3

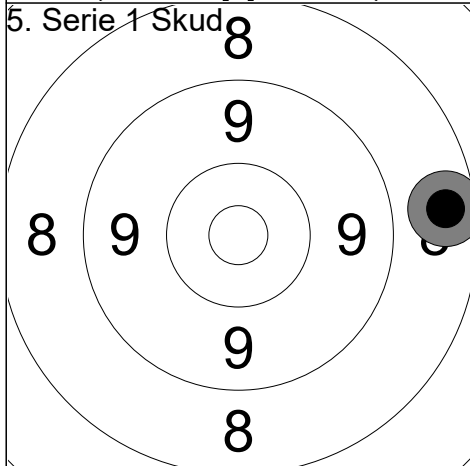

1:	8.5	→
----	-----	---

Serie	8.5
Total	81.8

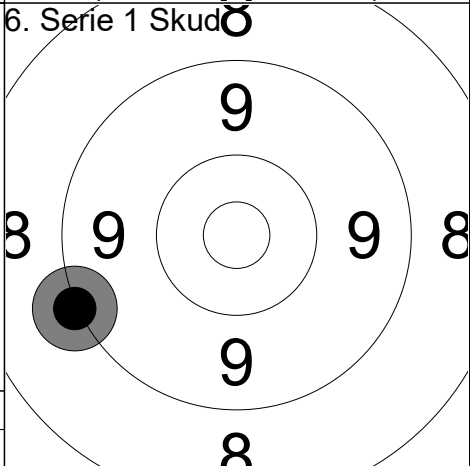

1:	9.1	←
----	-----	---

Serie	9.1
Total	90.9

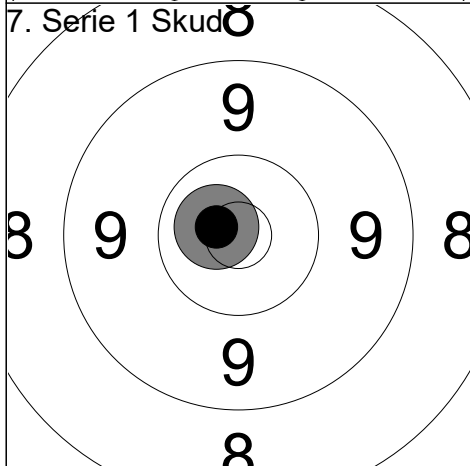

1:	10.7x	←
----	-------	---

Serie	10.7
Total	101.6

<p>1. Serie 5 Skud</p>	<p>1: 9.4 ← 2: 10.5x ↙ 3: 10.1 ↓ 4: 9.7 ↙ 5: 10.0 ↓</p>	<p>2. Serie 1 Skud</p>	<p>1: 7.0 ↓</p>								
	<table border="1" style="width:100%; border-collapse: collapse;"> <tr> <td style="width:50%;">Serie</td> <td style="text-align: right;">49.7</td> </tr> <tr> <td>Total</td> <td style="text-align: right;">49.7</td> </tr> </table>	Serie	49.7	Total	49.7		<table border="1" style="width:100%; border-collapse: collapse;"> <tr> <td style="width:50%;">Serie</td> <td style="text-align: right;">7.0</td> </tr> <tr> <td>Total</td> <td style="text-align: right;">56.7</td> </tr> </table>	Serie	7.0	Total	56.7
Serie	49.7										
Total	49.7										
Serie	7.0										
Total	56.7										

<p>3. Serie 1 Skud</p>	<p>1: 6.4 ←</p>	<p>4. Serie 1 Skud</p>	<p>1: 8.4 ↗</p>								
	<table border="1" style="width:100%; border-collapse: collapse;"> <tr> <td style="width:50%;">Serie</td> <td style="text-align: right;">6.4</td> </tr> <tr> <td>Total</td> <td style="text-align: right;">63.1</td> </tr> </table>	Serie	6.4	Total	63.1		<table border="1" style="width:100%; border-collapse: collapse;"> <tr> <td style="width:50%;">Serie</td> <td style="text-align: right;">8.4</td> </tr> <tr> <td>Total</td> <td style="text-align: right;">71.5</td> </tr> </table>	Serie	8.4	Total	71.5
Serie	6.4										
Total	63.1										
Serie	8.4										
Total	71.5										

<p>5. Serie 1 Skud</p>	<p>1: 8.3 ↓</p>						
	<table border="1" style="width:100%; border-collapse: collapse;"> <tr> <td style="width:50%;">Serie</td> <td style="text-align: right;">8.3</td> </tr> <tr> <td>Total</td> <td style="text-align: right;">79.8</td> </tr> </table>	Serie	8.3	Total	79.8		
Serie	8.3						
Total	79.8						