

1: 7.0 ↗	6: 10.3 →	Serie 97 (3x)
2: 10.1 →	7: 10.6x →	
3: 10.4 ↘	8: 10.3 ↑	Total 0 (0x)
4: 10.8x ↗	9: 10.1 ↑	
5: 10.8x →	10: 10.4 →	

11: 10.3 ↑	Serie 40 (2x)
12: 10.1 ↗	
13: 10.9x ↗	Total 0 (0x)
14: 10.6x →	

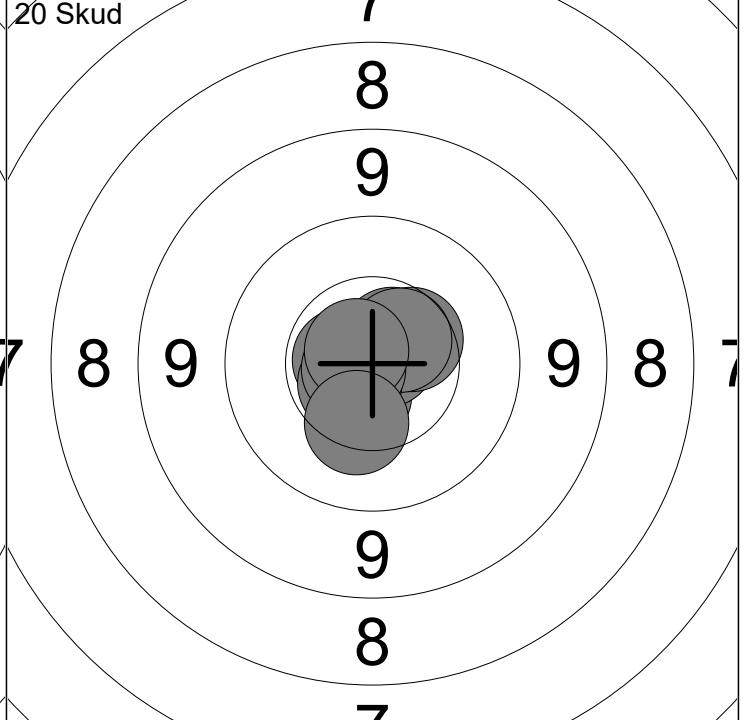
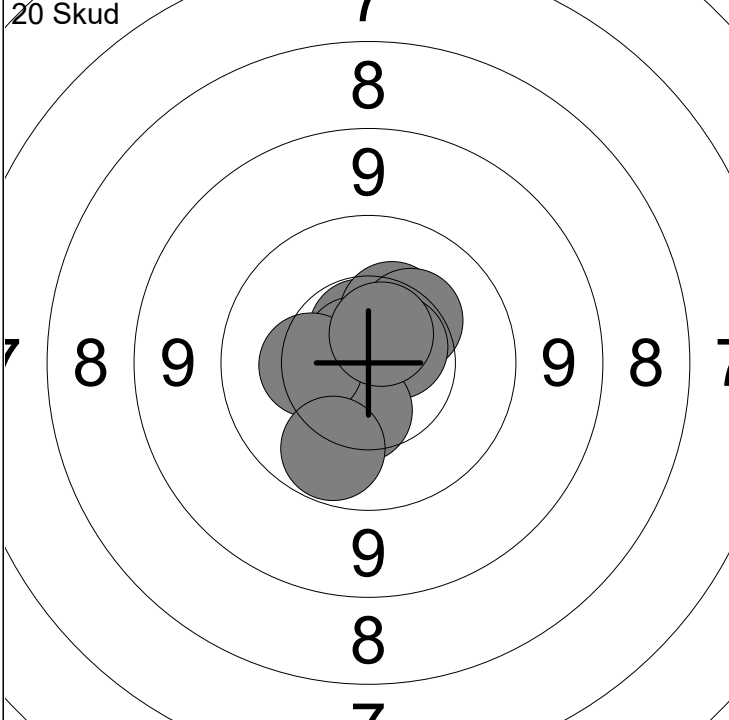

1: 10.6x ↑	6: 10.6x ↗	Serie 100 (5x)
2: 10.7x ↗	7: 10.4 ↓	
3: 10.7x ↖	8: 10.3 ←	Total 100 (5x)
4: 10.4 ↑	9: 10.0 ↓	
5: 10.3 ↗	10: 10.6x ↑	

11: 10.6x ↓	16: 10.6 ↗	Serie 100 (7x)
12: 10.8x ↗	17: 10.6x ↘	
13: 10.7x ←	18: 10.7x ←	Total 200 (12x)
14: 10.5 ↗	19: 10.7x ↖	
15: 10.6x ↗	20: 10.3 ↓	

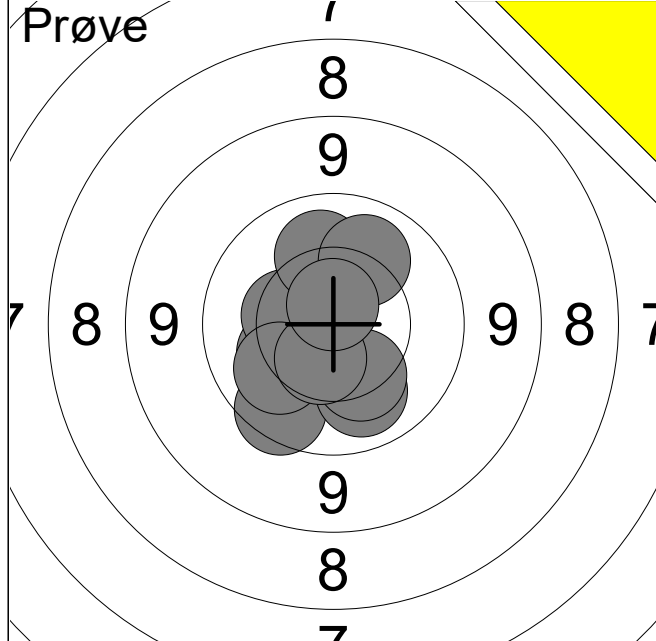

1:	9.8	↘
2:	10.1	↘
3:	10.3	↙
4:	10.4	↙
5:	10.1	↑
6:	10.1	↗
7:	10.3	↘
8:	10.1	↙
9:	10.5	↘
10:	10.7x	↑
Serie		99 (1x)
Total		0 (0x)

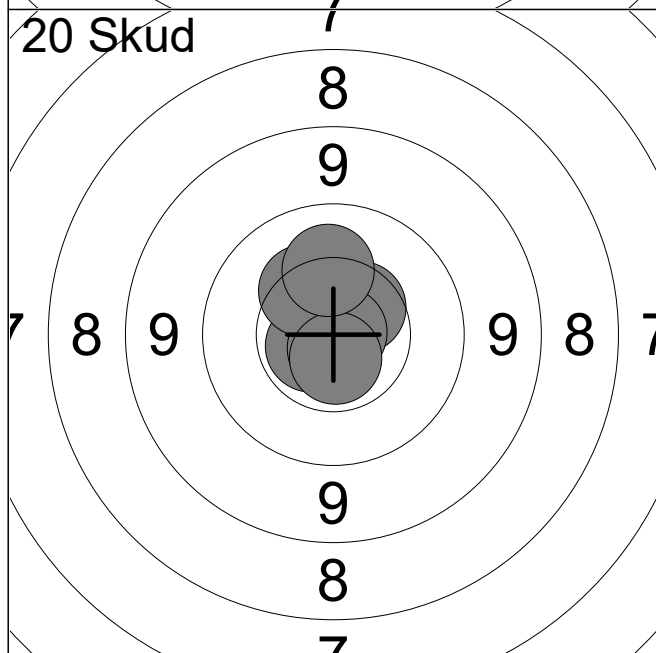

1:	10.6x	↑
2:	10.7x	↙
3:	10.8x	↗
4:	10.8x	↓
5:	10.7x	↑
6:	10.5	↗
7:	10.9x	→
8:	10.3	↖
9:	10.7x	↓
10:	10.2	↑
Serie		100 (7x)
Total		100 (7x)

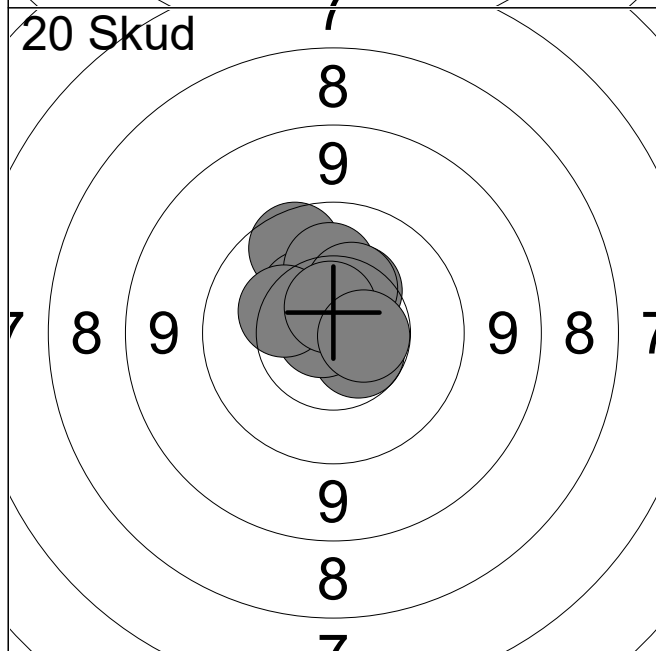

11:	10.6	↘
12:	9.8	↗
13:	10.4	↗
14:	10.8x	↙
15:	10.2	↑
16:	10.4	↗
17:	10.4	↗
18:	10.3	↙
19:	10.6x	↑
20:	10.6x	→
Serie		99 (3x)
Total		199 (10x)

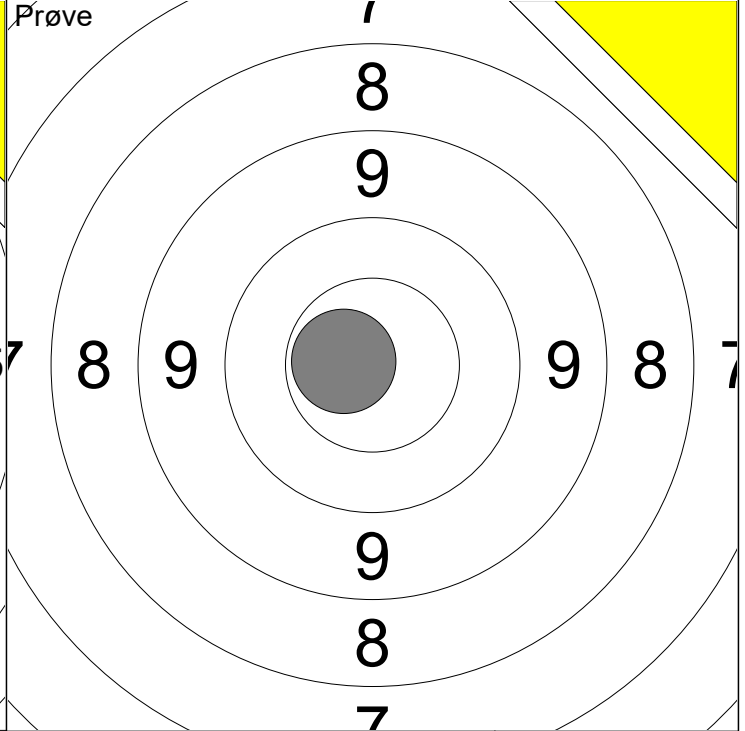
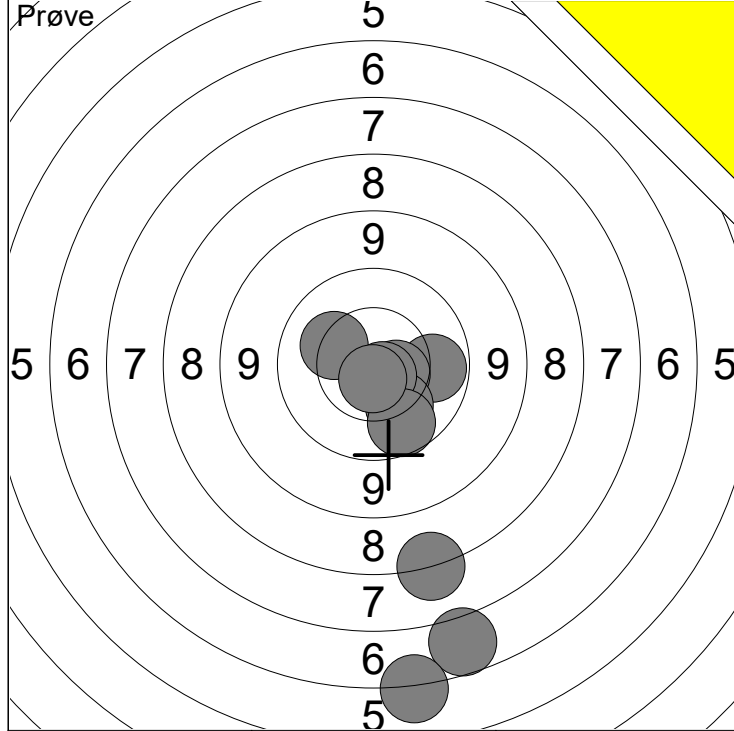

1: 5.9 ↓	6: 10.2 ↓	Serie 86 (2x)
2: 5.3 ↓	7: 10.7x ↓	
3: 7.3 ↓	8: 9.9 ↓	Total 0 (0x)
4: 10.0 →	9: 10.2 ↗	
5: 10.6 ↘	10: 10.7x ↓	

11: 10.6x ←	Serie 10 (1x)
	Total 0 (0x)

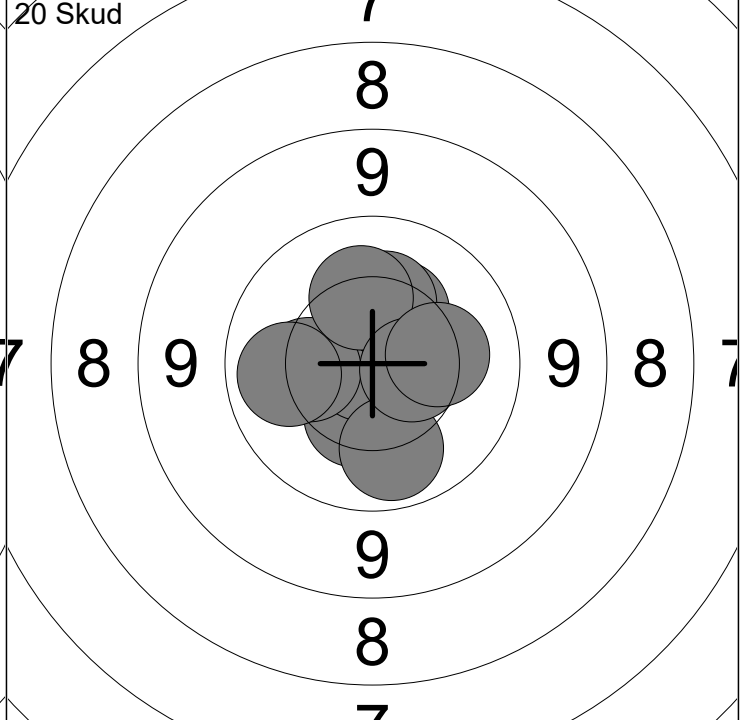
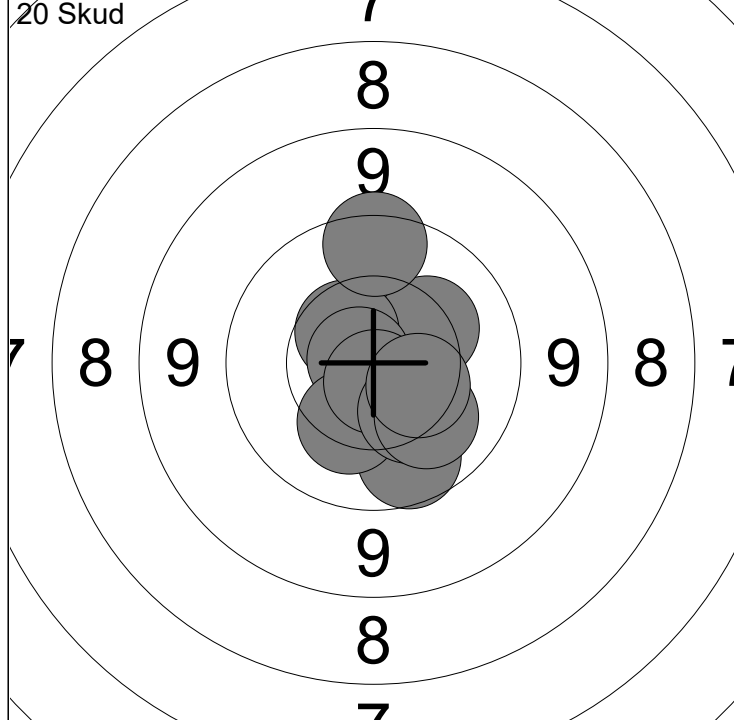

1: 9.9 ↓	6: 9.7 ↑	Serie 98 (2x)
2: 10.3 ↗	7: 10.7x ↓	
3: 10.5 ↗	8: 10.3 ↓	Total 98 (2x)
4: 10.8x ←	9: 10.2 ↓	
5: 10.3 ↓	10: 10.4 ↘	

11: 10.4 ↓	16: 10.0 ↓	Serie 100 (1x)
12: 10.8x ←	17: 10.3 ↑	
13: 10.3 ↗	18: 10.5 →	Total 198 (3x)
14: 10.3 ←	19: 10.3 →	
15: 10.3 ↑	20: 10.1 ←	

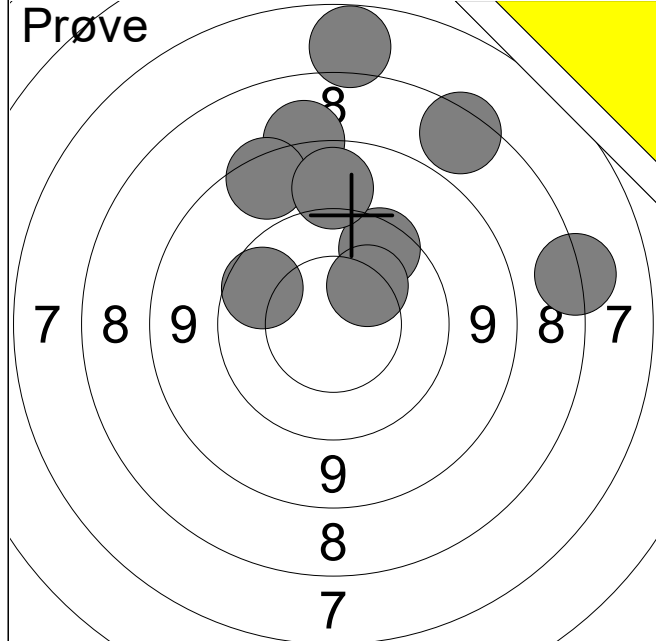

1:	7.0	↑
2:	7.4	→
3:	8.3	↑
4:	9.7	↗
5:	8.7	↖
6:	10.3	↗
7:	7.7	↗
8:	9.1	↑
9:	9.9	↖
Serie		74 (0x)
Total		0 (0x)

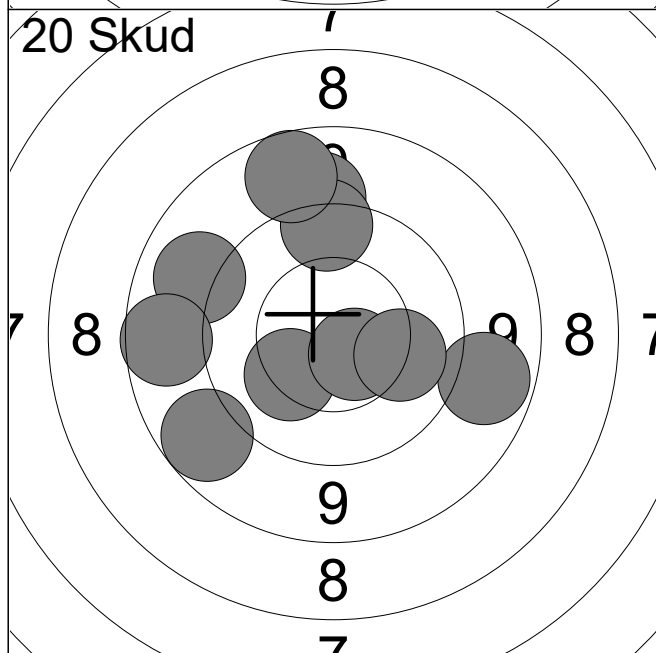

1:	10.3	↖
2:	9.3	↑
3:	9.0	→
4:	8.9	↖
5:	9.2	↖
6:	9.6	↑
7:	10.6x	↘
8:	8.9	←
9:	8.9	↑
10:	10.1	→
Serie		90 (1x)
Total		90 (1x)

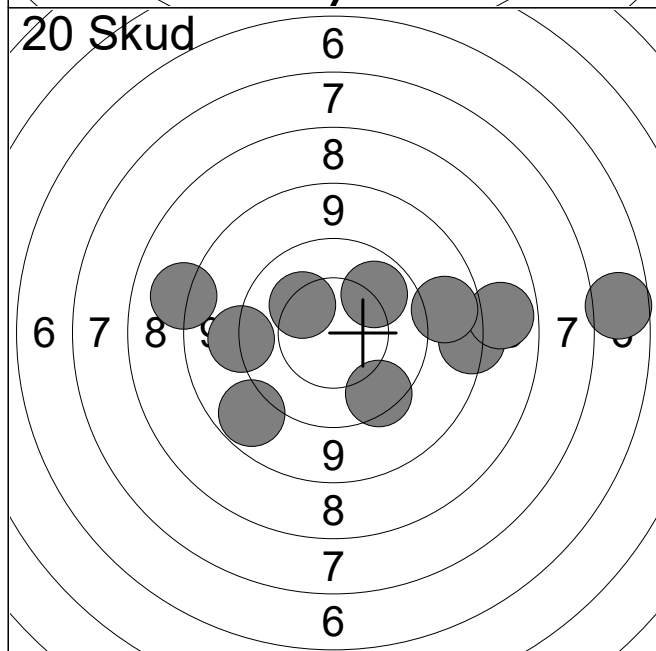

11:	8.6	→
12:	8.0	→
13:	9.4	←
14:	9.0	↖
15:	9.7	↘
16:	10.0	↗
17:	5.9	→
18:	9.0	→
19:	10.3	↗
20:	8.3	←
Serie		85 (0x)
Total		175 (1x)

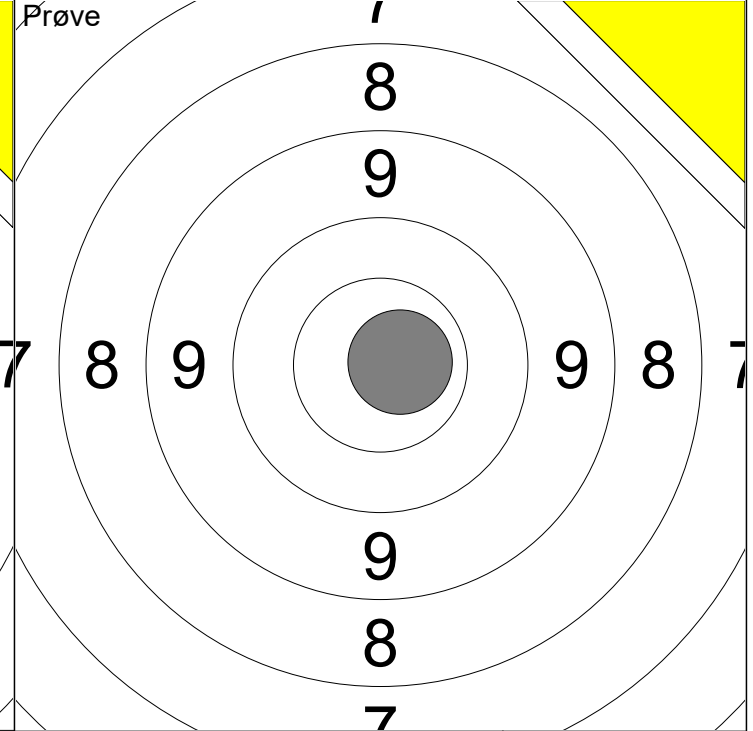
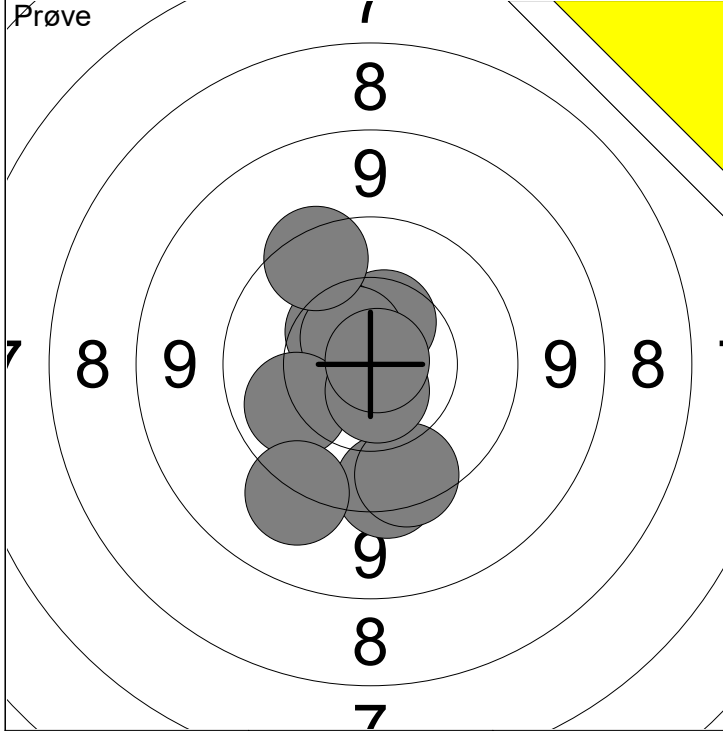

1: 10.5 ↗	6: 9.3 ↘	Serie 96 (3x)
2: 10.5 ↖	7: 9.7 ↘	
3: 10.6x ↗	8: 10.7x ↘	Total 0 (0x)
4: 10.1 ↖	9: 10.9x ↗	
5: 9.6 ↘	10: 9.7 ↗	

11: 10.7x →	Serie 10 (1x)
	Total 0 (0x)

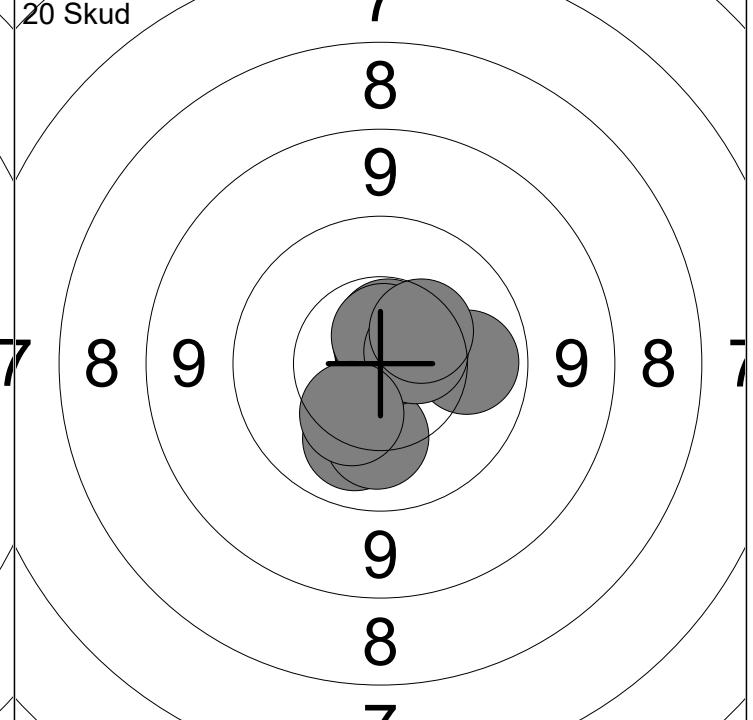
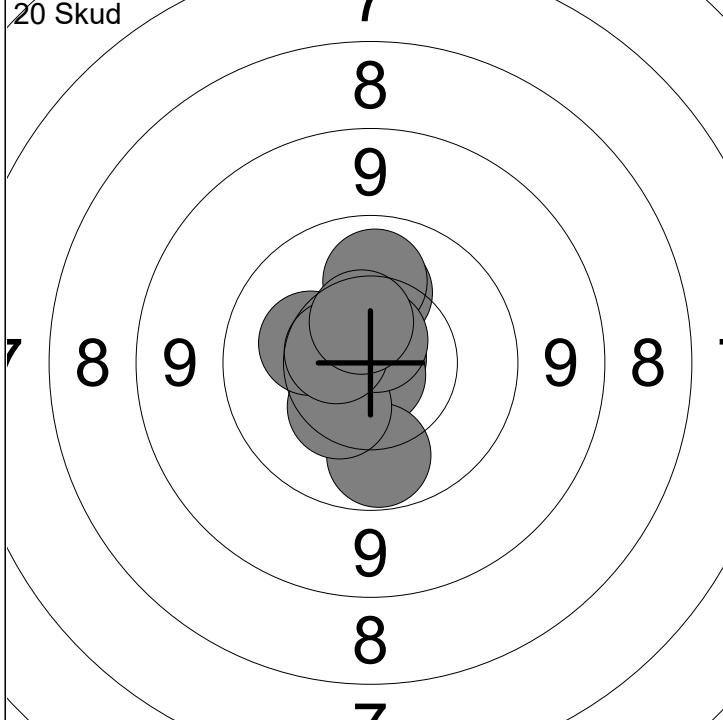

1: 10.9x ↗	6: 10.4 ↘	Serie 100 (3x)
2: 10.2 ↗	7: 10.7x ↗	
3: 10.8x ↘	8: 10.3 ↖	Total 100 (3x)
4: 10.1 ↗	9: 10.6 ↖	
5: 10.0 ↘	10: 10.5 ↗	

11: 10.1 ↘	16: 10.7x ↗	Serie 100 (4x)
12: 10.2 ↘	17: 10.7x ↗	
13: 10.8x ↗	18: 10.6 →	Total 200 (7x)
14: 10.6x ↗	19: 10.4 ↗	
15: 10.0 →	20: 10.3 ↘	

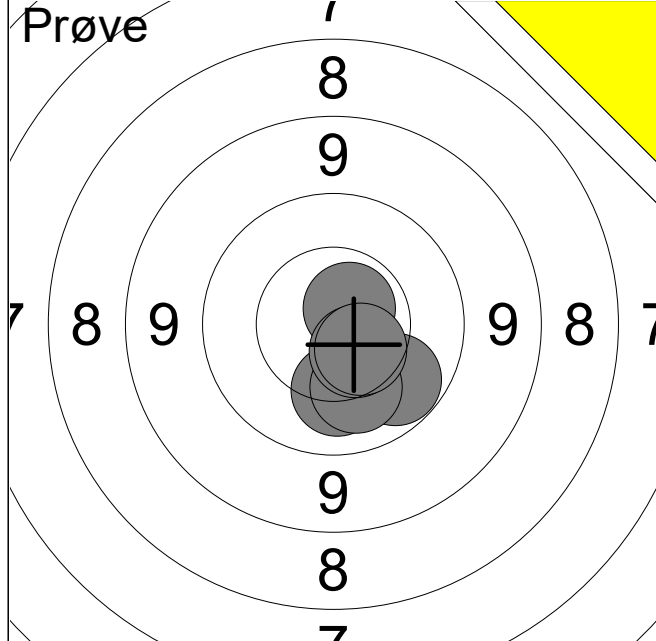

1:	10.0	↘
2:	10.2	↓
3:	10.2	↘
4:	10.7x	↗
5:	10.5	↘
6:	10.5	↘
Serie		60 (1x)
Total		0 (0x)

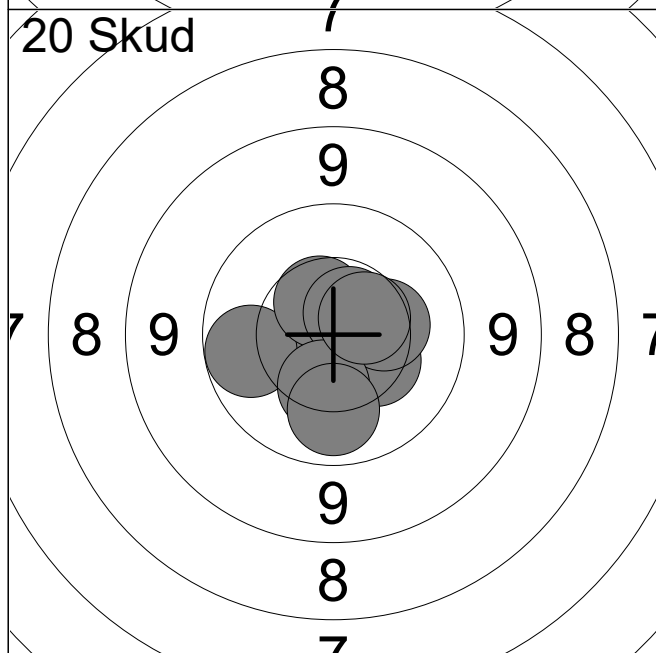

1:	10.8x	→
2:	10.7x	↓
3:	10.4	↘
4:	10.0	←
5:	10.5	↑
6:	10.6x	↗
7:	10.3	→
8:	10.3	↓
9:	10.5	↗
10:	10.1	↓
Serie		100 (3x)
Total		100 (3x)

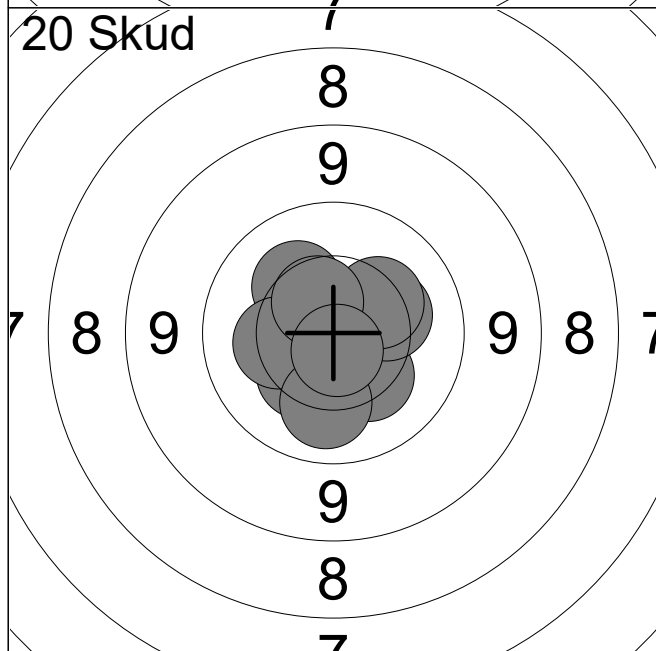

11:	10.3	↘
12:	10.3	↘
13:	10.9x	↗
14:	10.3	→
15:	10.3	↗
16:	10.3	←
17:	10.1	↓
18:	10.3	↗
19:	10.5	↑
20:	10.7x	↓
Serie		100 (2x)
Total		200 (5x)

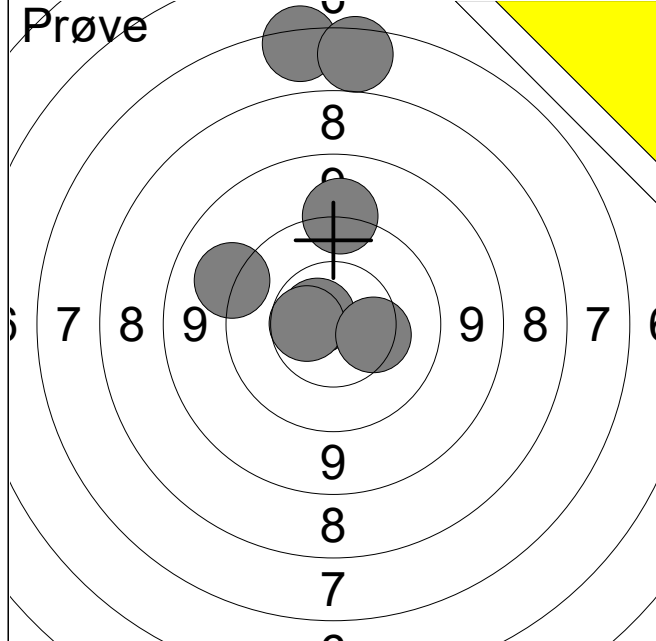

1:	6.6	↑
2:	6.8	↑
3:	9.3	↑
4:	10.7x	↖
5:	9.3	↖
6:	10.6	←
7:	10.3	→
Serie		60 (1x)
Total		0 (0x)

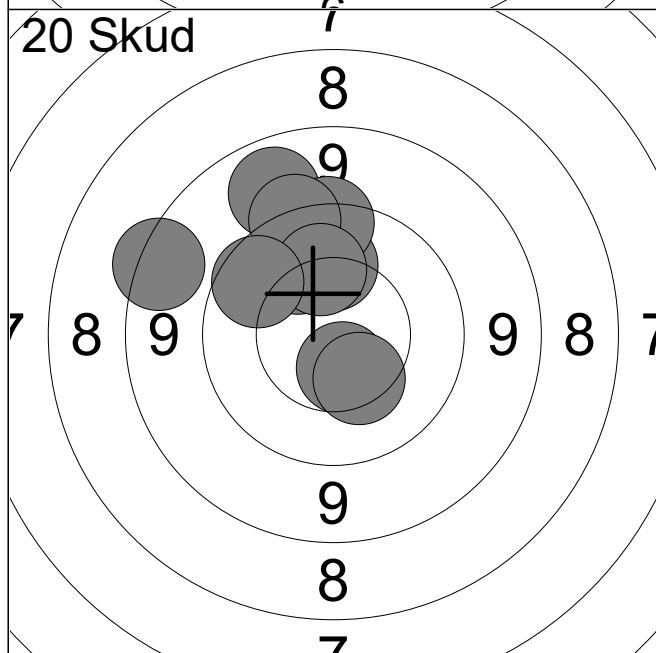

1:	10.5	↓
2:	10.1	↑
3:	9.1	↗
4:	9.6	↑
5:	10.1	↗
6:	8.6	↖
7:	9.5	↗
8:	10.2	↑
9:	10.4	↓
10:	9.8	↗
Serie		94 (0x)
Total		94 (0x)

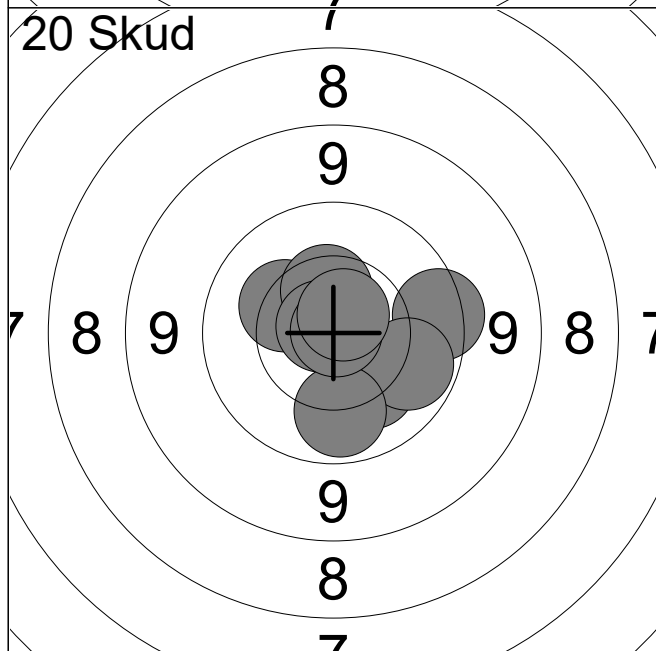

11:	10.2	↓
12:	10.8x	↗
13:	10.3	↗
14:	9.7	→
15:	10.4	↑
16:	10.0	↘
17:	10.8x	↗
18:	10.0	↓
19:	10.9x	↗
20:	10.7x	↗
Serie		99 (4x)
Total		193 (4x)

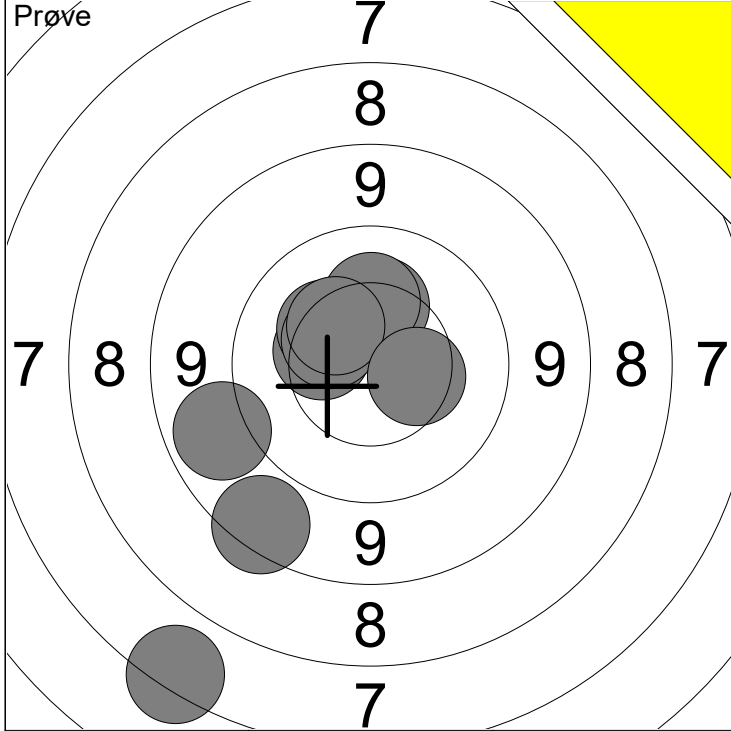

1: 6.6 ↓	6: 10.4 ↖
2: 8.7 ↓	7: 10.3 ↑
3: 9.1 ←	8: 10.3 ↑
4: 10.4 ↖	9: 10.4 ↗
5: 10.3 ↗	10: 10.4 →

Serie	93 (0x)
Total	0 (0x)

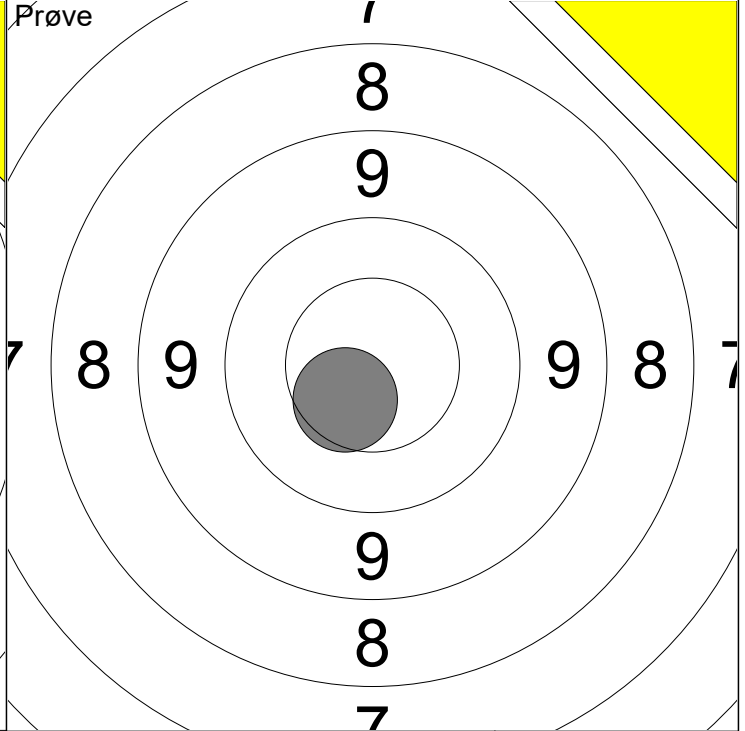

11: 10.5 ↓

Serie	10 (0x)
Total	0 (0x)

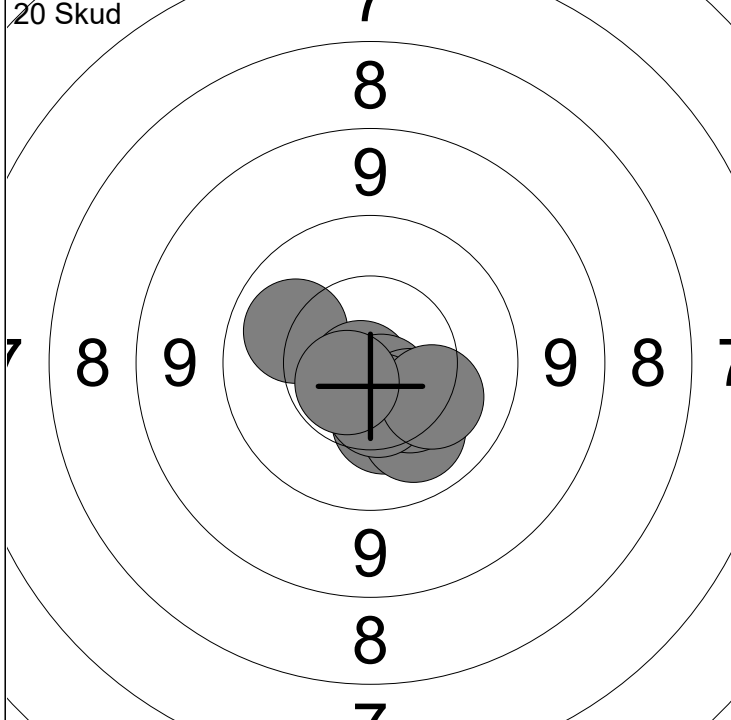

1: 10.3 ↓	6: 10.1 ↓
2: 10.1 ↖	7: 10.4 ↓
3: 10.2 ↓	8: 10.5 ↓
4: 10.8x ↖	9: 10.2 ↓
5: 10.7x ↓	10: 10.6x ↖

Serie	100 (3x)
Total	100 (3x)

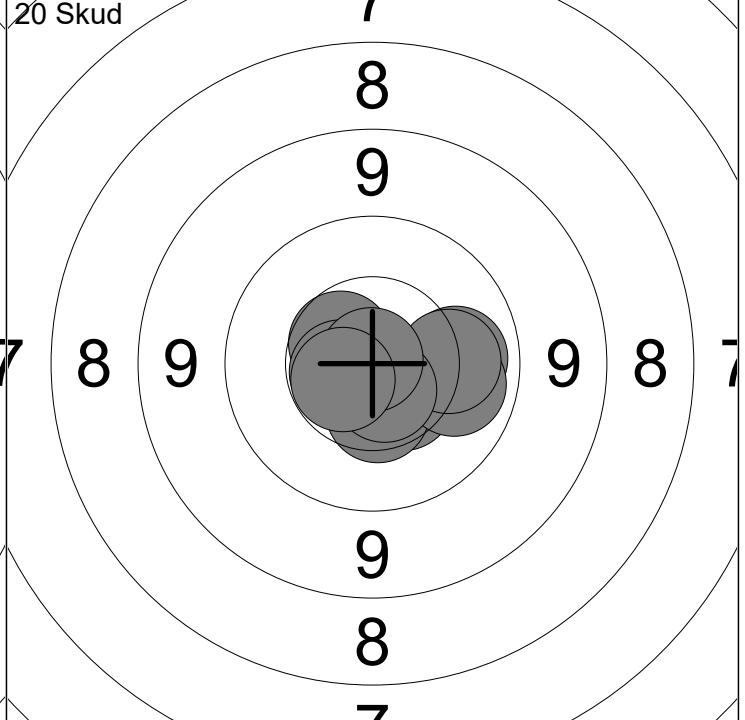

11: 10.6 ↖	16: 10.1 →
12: 10.5 ↓	17: 10.2 →
13: 10.5 ↓	18: 10.6x ↓
14: 10.6x ↖	19: 10.9x ↑
15: 10.1 →	20: 10.6x ↖

Serie	100 (4x)
Total	200 (7x)

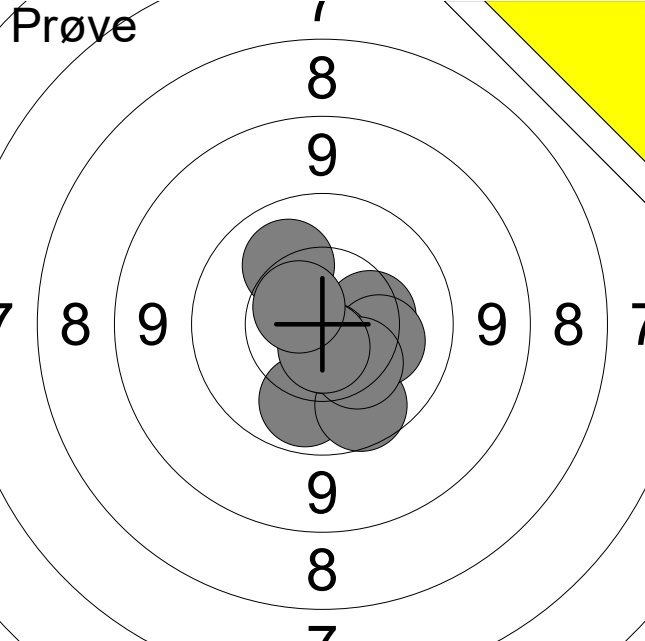
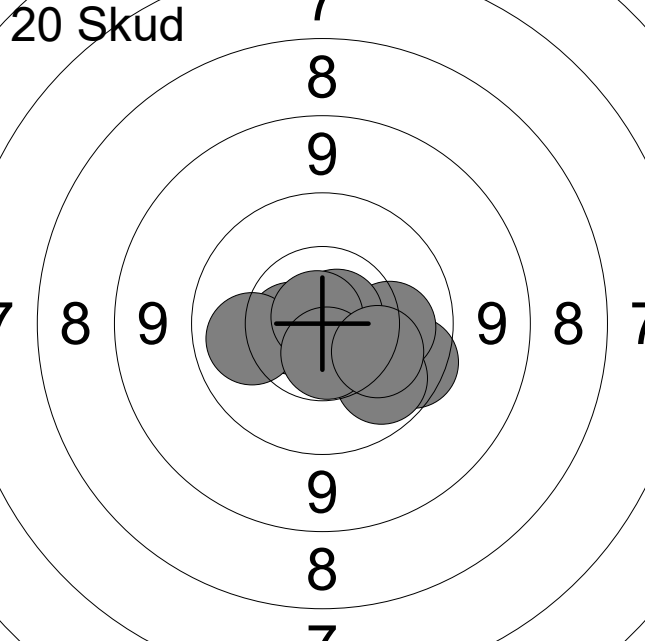
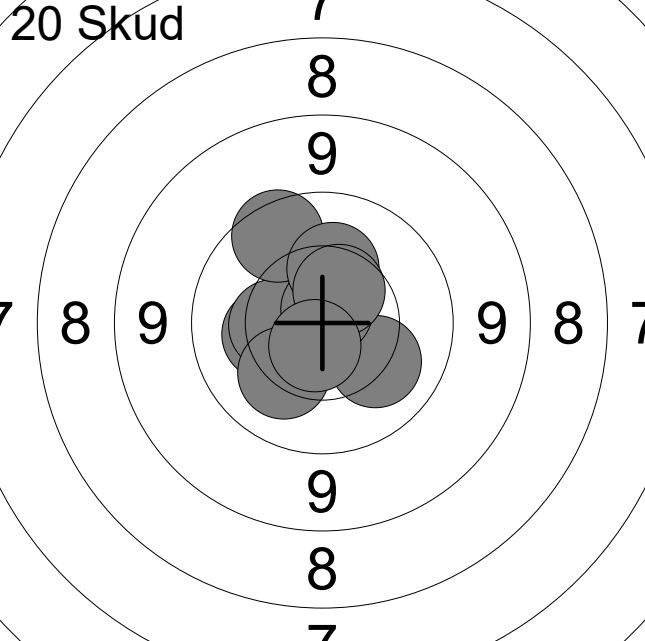
Hold 3	Skive 11	Jeppe Thune																																
ØSF		Ganløse Skytteforening		BK1																														
28.10.2024		Halloween Luftstævne 2024		Ølstykke skytteforening																														
Prøve		<table border="0"> <tr><td>1:</td><td>10.7x</td><td>↘</td></tr> <tr><td>2:</td><td>10.0</td><td>↘</td></tr> <tr><td>3:</td><td>9.9</td><td>↘</td></tr> <tr><td>4:</td><td>10.4</td><td>→</td></tr> <tr><td>5:</td><td>10.2</td><td>↗</td></tr> <tr><td>6:</td><td>10.2</td><td>→</td></tr> <tr><td>7:</td><td>10.7x</td><td>↘</td></tr> <tr><td>8:</td><td>10.3</td><td>↘</td></tr> <tr><td>9:</td><td>10.7x</td><td>↘</td></tr> <tr><td>10:</td><td>10.6x</td><td>↗</td></tr> </table>			1:	10.7x	↘	2:	10.0	↘	3:	9.9	↘	4:	10.4	→	5:	10.2	↗	6:	10.2	→	7:	10.7x	↘	8:	10.3	↘	9:	10.7x	↘	10:	10.6x	↗
1:	10.7x	↘																																
2:	10.0	↘																																
3:	9.9	↘																																
4:	10.4	→																																
5:	10.2	↗																																
6:	10.2	→																																
7:	10.7x	↘																																
8:	10.3	↘																																
9:	10.7x	↘																																
10:	10.6x	↗																																
		Serie 99 (4x)																																
		Total 0 (0x)																																
20 Skud		<table border="0"> <tr><td>1:</td><td>9.8</td><td>↘</td></tr> <tr><td>2:</td><td>10.2</td><td>→</td></tr> <tr><td>3:</td><td>10.6x</td><td>←</td></tr> <tr><td>4:</td><td>10.1</td><td>←</td></tr> <tr><td>5:</td><td>10.8x</td><td>↘</td></tr> <tr><td>6:</td><td>10.0</td><td>↘</td></tr> <tr><td>7:</td><td>10.8x</td><td>↗</td></tr> <tr><td>8:</td><td>10.8x</td><td>↗</td></tr> <tr><td>9:</td><td>10.6x</td><td>↘</td></tr> <tr><td>10:</td><td>10.2</td><td>↘</td></tr> </table>			1:	9.8	↘	2:	10.2	→	3:	10.6x	←	4:	10.1	←	5:	10.8x	↘	6:	10.0	↘	7:	10.8x	↗	8:	10.8x	↗	9:	10.6x	↘	10:	10.2	↘
1:	9.8	↘																																
2:	10.2	→																																
3:	10.6x	←																																
4:	10.1	←																																
5:	10.8x	↘																																
6:	10.0	↘																																
7:	10.8x	↗																																
8:	10.8x	↗																																
9:	10.6x	↘																																
10:	10.2	↘																																
		Serie 99 (5x)																																
		Total 99 (5x)																																
20 Skud		<table border="0"> <tr><td>11:</td><td>10.3</td><td>←</td></tr> <tr><td>12:</td><td>10.2</td><td>↘</td></tr> <tr><td>13:</td><td>10.8x</td><td>↘</td></tr> <tr><td>14:</td><td>10.4</td><td>←</td></tr> <tr><td>15:</td><td>10.8x</td><td>↗</td></tr> <tr><td>16:</td><td>9.8</td><td>↗</td></tr> <tr><td>17:</td><td>10.3</td><td>↗</td></tr> <tr><td>18:</td><td>10.5</td><td>↗</td></tr> <tr><td>19:</td><td>10.2</td><td>↘</td></tr> <tr><td>20:</td><td>10.7x</td><td>↘</td></tr> </table>			11:	10.3	←	12:	10.2	↘	13:	10.8x	↘	14:	10.4	←	15:	10.8x	↗	16:	9.8	↗	17:	10.3	↗	18:	10.5	↗	19:	10.2	↘	20:	10.7x	↘
11:	10.3	←																																
12:	10.2	↘																																
13:	10.8x	↘																																
14:	10.4	←																																
15:	10.8x	↗																																
16:	9.8	↗																																
17:	10.3	↗																																
18:	10.5	↗																																
19:	10.2	↘																																
20:	10.7x	↘																																
		Serie 99 (3x)																																
		Total 198 (8x)																																

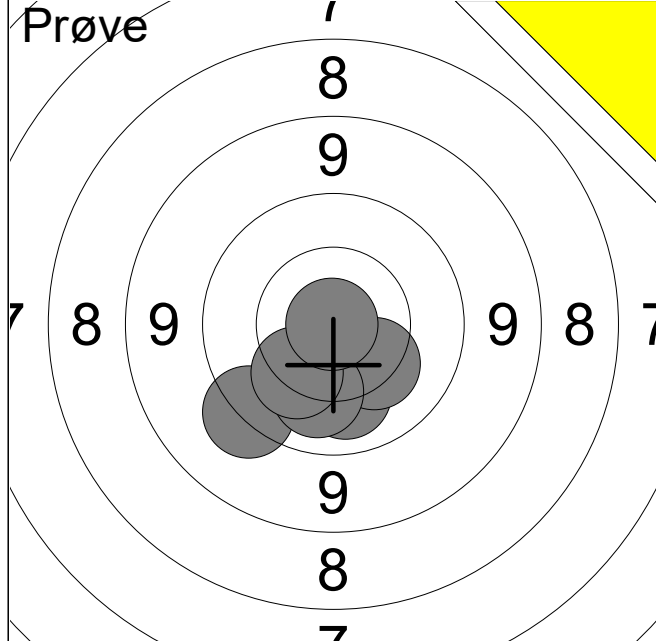

1:	9.5	↙
2:	10.1	↓
3:	10.3	↘
4:	10.1	↓
5:	10.2	↙
6:	10.9x	←
Serie		59 (1x)
Total		0 (0x)

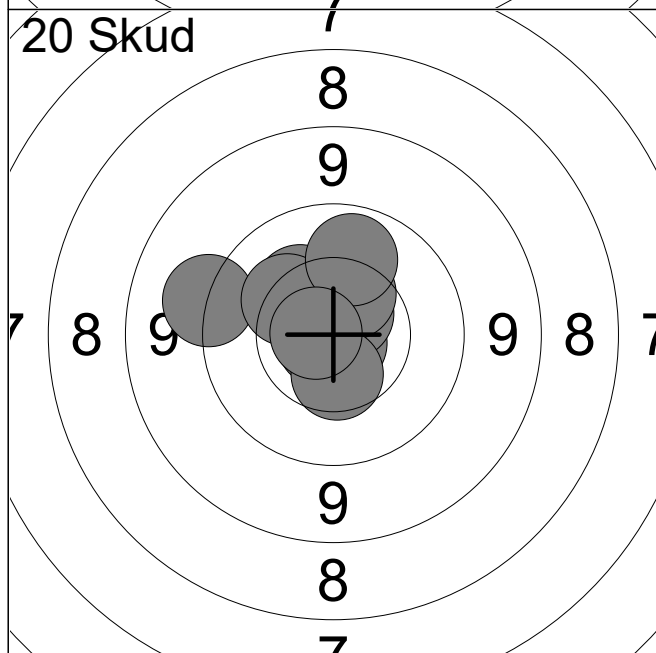

1:	10.8x	↘
2:	10.8x	↙
3:	10.3	↗
4:	9.4	←
5:	10.6x	↗
6:	10.4	↗
7:	10.3	↗
8:	10.5	↓
9:	10.0	↗
10:	10.7x	←
Serie		99 (4x)
Total		99 (4x)

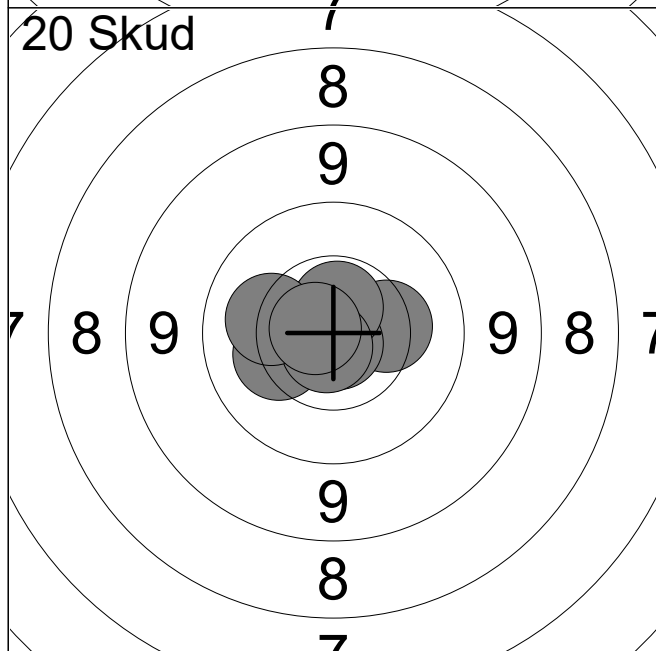

11:	10.8x	↗
12:	10.3	→
13:	10.8x	←
14:	10.3	←
15:	10.8x	↗
16:	10.8x	↓
17:	10.6x	↗
18:	10.8x	↓
19:	10.2	←
20:	10.7x	←
Serie		100 (7x)
Total		199 (11x)

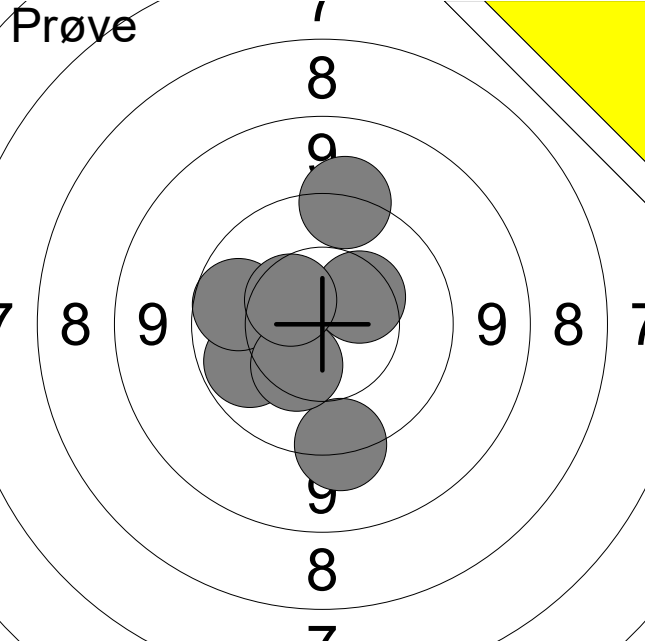
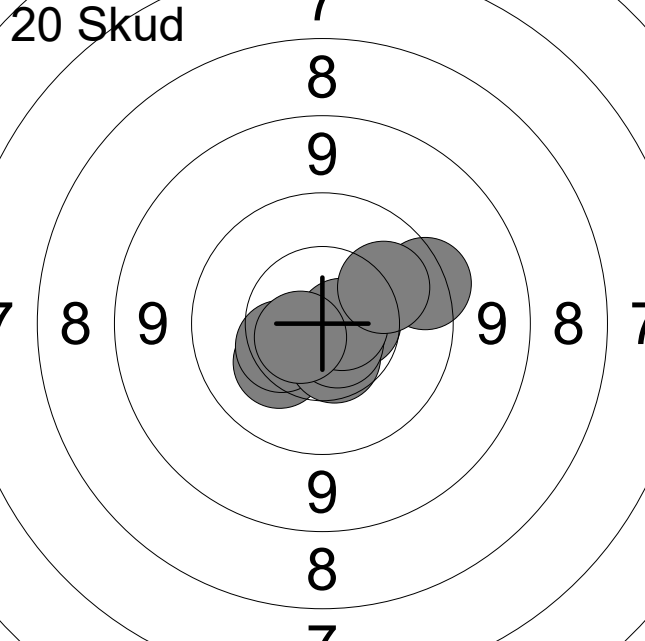
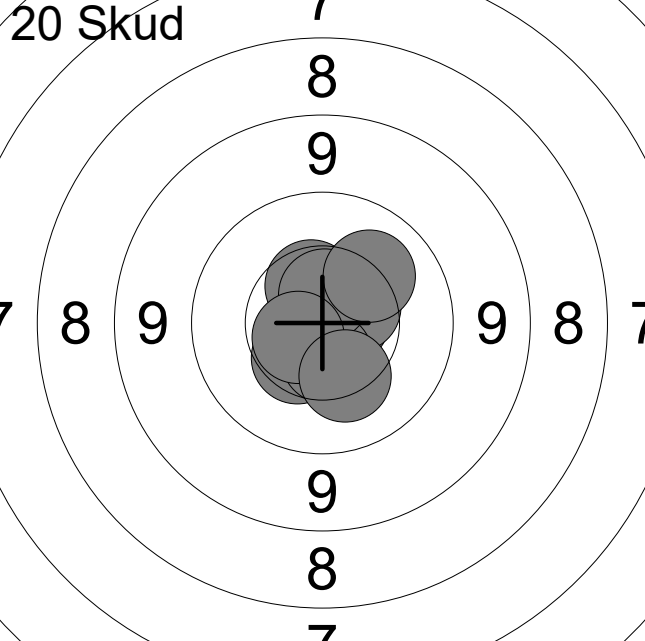
Hold 4	Skive 4	Sara Aaslev Noerager Bay																																
ØSF		Ølstykke Skytteforening		J1																														
28.10.2024		Halloween Luftstævne 2024		Ølstykke skytteforening																														
Prøve		<table border="0"> <tr><td>1:</td><td>10.0</td><td>↖</td></tr> <tr><td>2:</td><td>9.5</td><td>↓</td></tr> <tr><td>3:</td><td>9.9</td><td>←</td></tr> <tr><td>4:</td><td>9.4</td><td>↑</td></tr> <tr><td>5:</td><td>10.4</td><td>↗</td></tr> <tr><td>6:</td><td>10.4</td><td>↘</td></tr> <tr><td>7:</td><td>10.5</td><td>↖</td></tr> </table>			1:	10.0	↖	2:	9.5	↓	3:	9.9	←	4:	9.4	↑	5:	10.4	↗	6:	10.4	↘	7:	10.5	↖									
1:	10.0	↖																																
2:	9.5	↓																																
3:	9.9	←																																
4:	9.4	↑																																
5:	10.4	↗																																
6:	10.4	↘																																
7:	10.5	↖																																
		Serie 67 (0x)																																
		Total 0 (0x)																																
20 Skud		<table border="0"> <tr><td>1:</td><td>10.6</td><td>→</td></tr> <tr><td>2:</td><td>10.3</td><td>↘</td></tr> <tr><td>3:</td><td>10.7x</td><td>↘</td></tr> <tr><td>4:</td><td>10.4</td><td>←</td></tr> <tr><td>5:</td><td>10.5</td><td>↓</td></tr> <tr><td>6:</td><td>10.7x</td><td>↘</td></tr> <tr><td>7:</td><td>10.7x</td><td>→</td></tr> <tr><td>8:</td><td>9.6</td><td>↗</td></tr> <tr><td>9:</td><td>10.1</td><td>↗</td></tr> <tr><td>10:</td><td>10.6x</td><td>↘</td></tr> </table>			1:	10.6	→	2:	10.3	↘	3:	10.7x	↘	4:	10.4	←	5:	10.5	↓	6:	10.7x	↘	7:	10.7x	→	8:	9.6	↗	9:	10.1	↗	10:	10.6x	↘
1:	10.6	→																																
2:	10.3	↘																																
3:	10.7x	↘																																
4:	10.4	←																																
5:	10.5	↓																																
6:	10.7x	↘																																
7:	10.7x	→																																
8:	9.6	↗																																
9:	10.1	↗																																
10:	10.6x	↘																																
		Serie 99 (4x)																																
		Total 99 (4x)																																
20 Skud		<table border="0"> <tr><td>11:</td><td>10.7x</td><td>→</td></tr> <tr><td>12:</td><td>10.8x</td><td>↑</td></tr> <tr><td>13:</td><td>10.5</td><td>↗</td></tr> <tr><td>14:</td><td>10.4</td><td>↘</td></tr> <tr><td>15:</td><td>10.5</td><td>↑</td></tr> <tr><td>16:</td><td>10.5</td><td>↓</td></tr> <tr><td>17:</td><td>10.6x</td><td>↑</td></tr> <tr><td>18:</td><td>10.6x</td><td>←</td></tr> <tr><td>19:</td><td>10.3</td><td>↓</td></tr> <tr><td>20:</td><td>10.2</td><td>↗</td></tr> </table>			11:	10.7x	→	12:	10.8x	↑	13:	10.5	↗	14:	10.4	↘	15:	10.5	↑	16:	10.5	↓	17:	10.6x	↑	18:	10.6x	←	19:	10.3	↓	20:	10.2	↗
11:	10.7x	→																																
12:	10.8x	↑																																
13:	10.5	↗																																
14:	10.4	↘																																
15:	10.5	↑																																
16:	10.5	↓																																
17:	10.6x	↑																																
18:	10.6x	←																																
19:	10.3	↓																																
20:	10.2	↗																																
		Serie 100 (4x)																																
		Total 199 (8x)																																

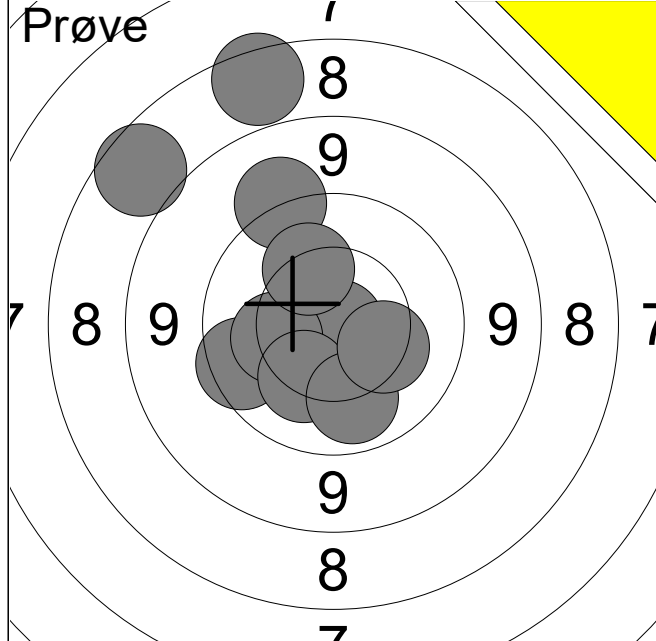

1:	7.8	↗
2:	7.7	↑
3:	9.3	↗
4:	9.8	↖
5:	10.9x	→
6:	10.3	↖
7:	10.2	↘
8:	10.2	↑
9:	10.1	↘
10:	10.3	→
Serie		92 (1x)
Total		0 (0x)

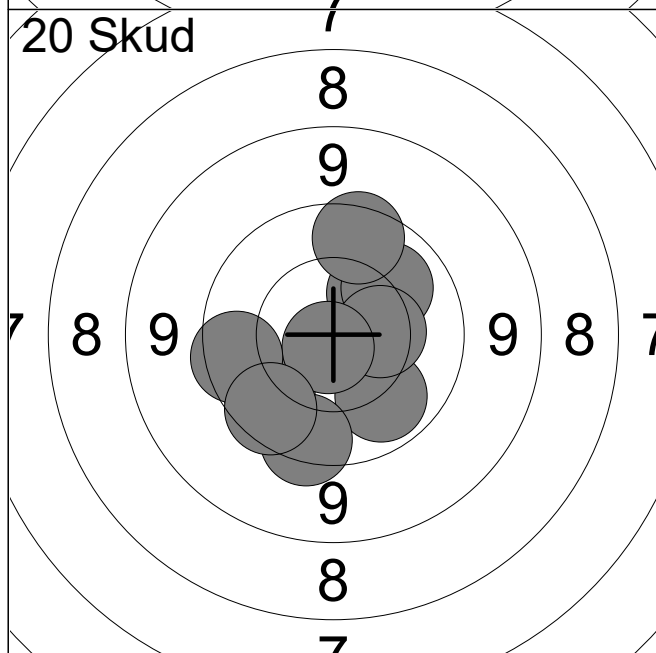

1:	10.0	↘
2:	10.3	↗
3:	9.6	↘
4:	10.1	↗
5:	10.4	→
6:	9.9	↖
7:	9.8	↑
8:	10.8x	↘
9:	9.8	↖
10:	9.8	↘
Serie		95 (1x)
Total		95 (1x)

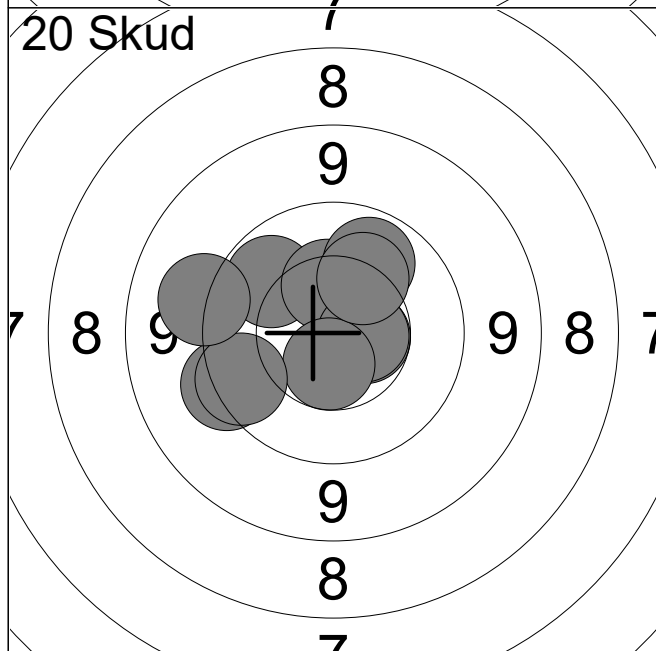

11:	10.0	↗
12:	9.5	↖
13:	10.6	→
14:	10.4	↑
15:	10.6x	→
16:	10.6	↘
17:	10.0	↗
18:	10.2	↗
19:	9.7	↖
20:	9.3	↖
Serie		97 (1x)
Total		192 (2x)

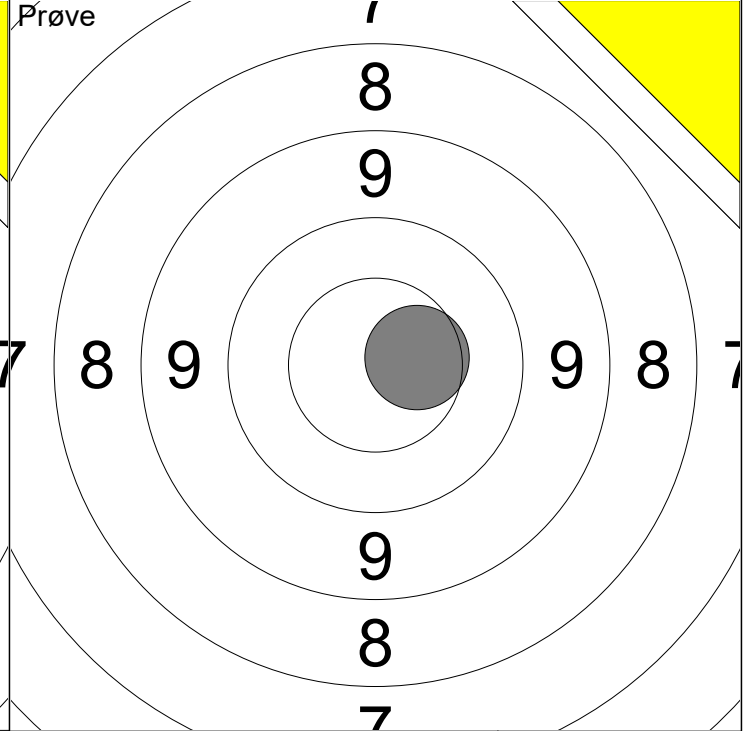
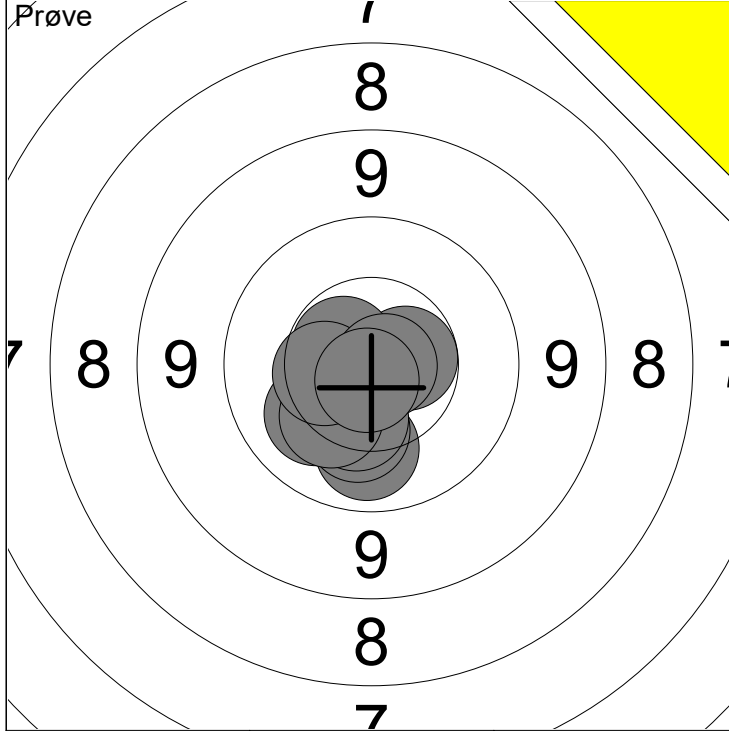

1: 10.1 ↓	6: 10.2 ↙	Serie 100 (4x)
2: 10.6x →	7: 10.3 ↘	
3: 10.2 ↓	8: 10.4 ←	Total 0 (0x)
4: 10.6x ↖	9: 10.8x →	
5: 10.4 ↓	10: 10.8x ↓	

11: 10.5 →	Serie 10 (0x)
	Total 0 (0x)

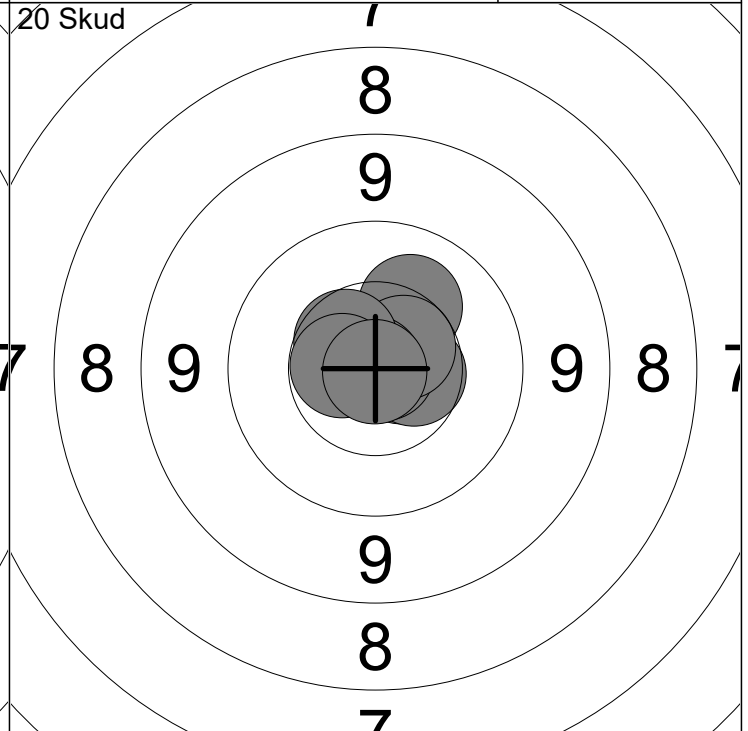
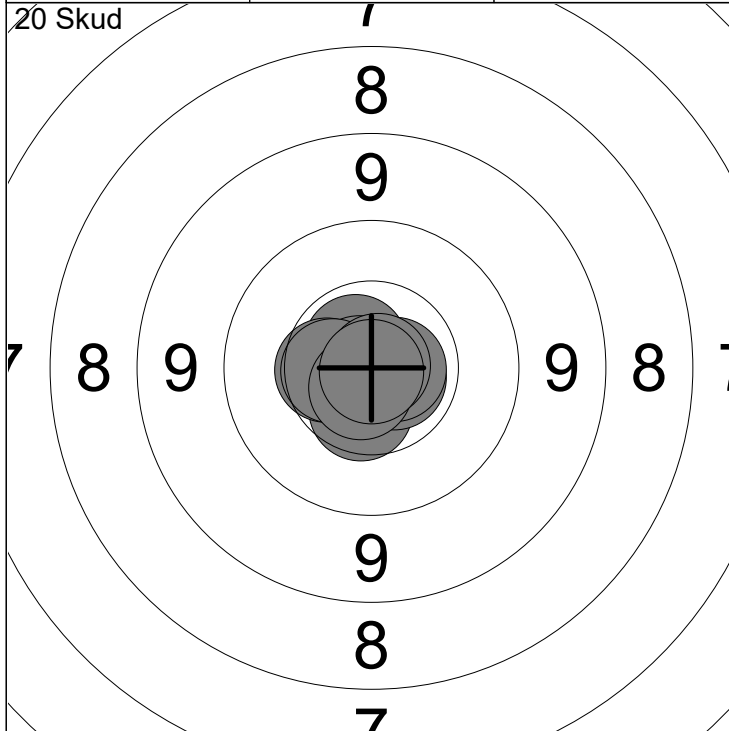

1: 10.5 ↓	6: 10.5 ←	Serie 100 (7x)
2: 10.7x →	7: 10.7x →	
3: 10.7x ↗	8: 10.9x →	Total 100 (7x)
4: 10.5 ←	9: 10.7x ↓	
5: 10.8x ←	10: 10.9x ↓	

11: 10.7x →	16: 10.6 ↗	Serie 100 (6x)
12: 10.5 →	17: 10.9x ↖	
13: 10.2 ↗	18: 10.5 ↖	Total 200 (13x)
14: 10.9x ←	19: 10.6x ←	
15: 10.9x →	20: 10.9x ↓	

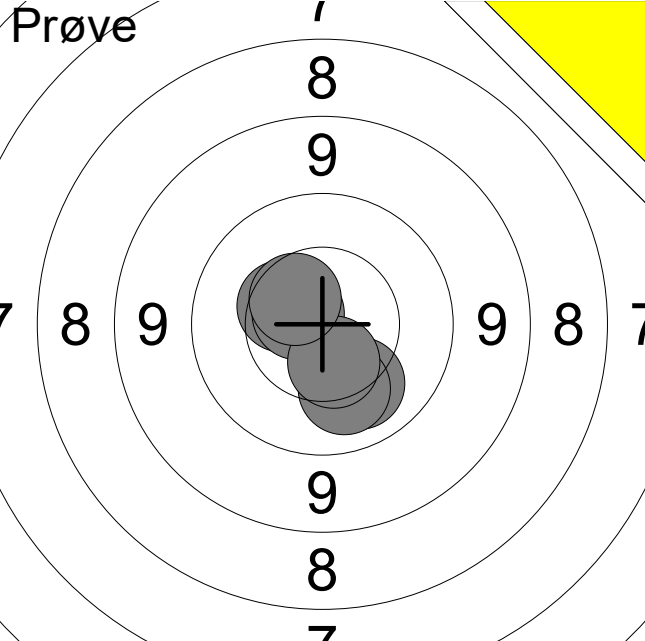
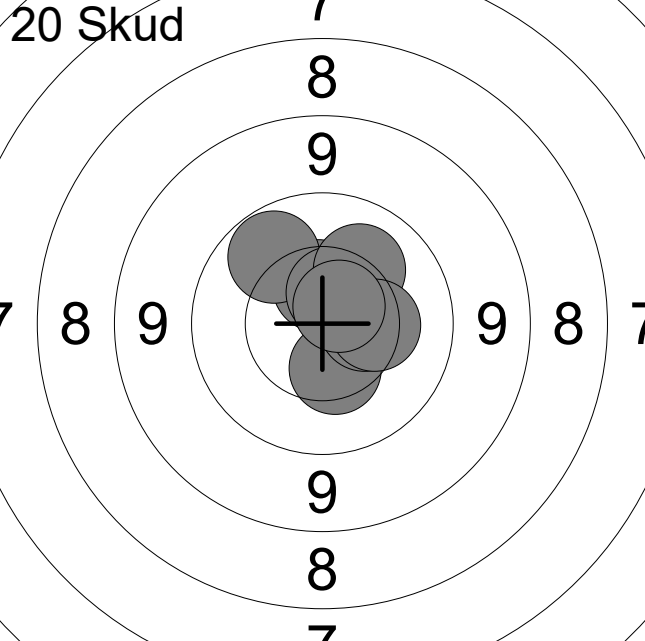
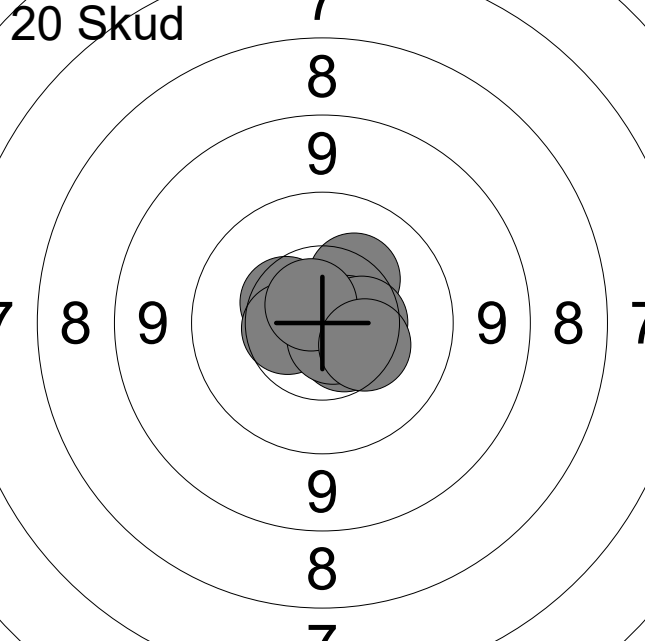
Hold 4	Skive 10	Laerke Hyldegaard																																
ØSF		Ganløse Skytteforening		MBK2																														
28.10.2024		Halloween Luftstævne 2024		Ølstykke skytteforening																														
Prøve		<table border="0"> <tr><td>1:</td><td>10.1</td><td>↘</td></tr> <tr><td>2:</td><td>10.1</td><td>↘</td></tr> <tr><td>3:</td><td>10.4</td><td>↗</td></tr> <tr><td>4:</td><td>10.6x</td><td>↗</td></tr> <tr><td>5:</td><td>10.5</td><td>↘</td></tr> <tr><td>6:</td><td>10.5</td><td>↗</td></tr> </table>			1:	10.1	↘	2:	10.1	↘	3:	10.4	↗	4:	10.6x	↗	5:	10.5	↘	6:	10.5	↗												
1:	10.1	↘																																
2:	10.1	↘																																
3:	10.4	↗																																
4:	10.6x	↗																																
5:	10.5	↘																																
6:	10.5	↗																																
		Serie 60 (1x)																																
		Total 0 (0x)																																
20 Skud		<table border="0"> <tr><td>1:</td><td>10.5</td><td>↑</td></tr> <tr><td>2:</td><td>10.0</td><td>↗</td></tr> <tr><td>3:</td><td>10.5</td><td>→</td></tr> <tr><td>4:</td><td>10.4</td><td>↘</td></tr> <tr><td>5:</td><td>10.3</td><td>↗</td></tr> <tr><td>6:</td><td>10.6</td><td>↑</td></tr> <tr><td>7:</td><td>10.4</td><td>→</td></tr> <tr><td>8:</td><td>10.2</td><td>↗</td></tr> <tr><td>9:</td><td>10.3</td><td>→</td></tr> <tr><td>10:</td><td>10.7x</td><td>↗</td></tr> </table>			1:	10.5	↑	2:	10.0	↗	3:	10.5	→	4:	10.4	↘	5:	10.3	↗	6:	10.6	↑	7:	10.4	→	8:	10.2	↗	9:	10.3	→	10:	10.7x	↗
1:	10.5	↑																																
2:	10.0	↗																																
3:	10.5	→																																
4:	10.4	↘																																
5:	10.3	↗																																
6:	10.6	↑																																
7:	10.4	→																																
8:	10.2	↗																																
9:	10.3	→																																
10:	10.7x	↗																																
		Serie 100 (1x)																																
		Total 100 (1x)																																
20 Skud		<table border="0"> <tr><td>11:</td><td>10.5</td><td>↖</td></tr> <tr><td>12:</td><td>10.3</td><td>↗</td></tr> <tr><td>13:</td><td>10.6</td><td>↘</td></tr> <tr><td>14:</td><td>10.9x</td><td>↗</td></tr> <tr><td>15:</td><td>10.5</td><td>←</td></tr> <tr><td>16:</td><td>10.7x</td><td>→</td></tr> <tr><td>17:</td><td>10.7x</td><td>↘</td></tr> <tr><td>18:</td><td>10.5</td><td>→</td></tr> <tr><td>19:</td><td>10.7x</td><td>↗</td></tr> <tr><td>20:</td><td>10.4</td><td>↘</td></tr> </table>			11:	10.5	↖	12:	10.3	↗	13:	10.6	↘	14:	10.9x	↗	15:	10.5	←	16:	10.7x	→	17:	10.7x	↘	18:	10.5	→	19:	10.7x	↗	20:	10.4	↘
11:	10.5	↖																																
12:	10.3	↗																																
13:	10.6	↘																																
14:	10.9x	↗																																
15:	10.5	←																																
16:	10.7x	→																																
17:	10.7x	↘																																
18:	10.5	→																																
19:	10.7x	↗																																
20:	10.4	↘																																
		Serie 100 (4x)																																
		Total 200 (5x)																																

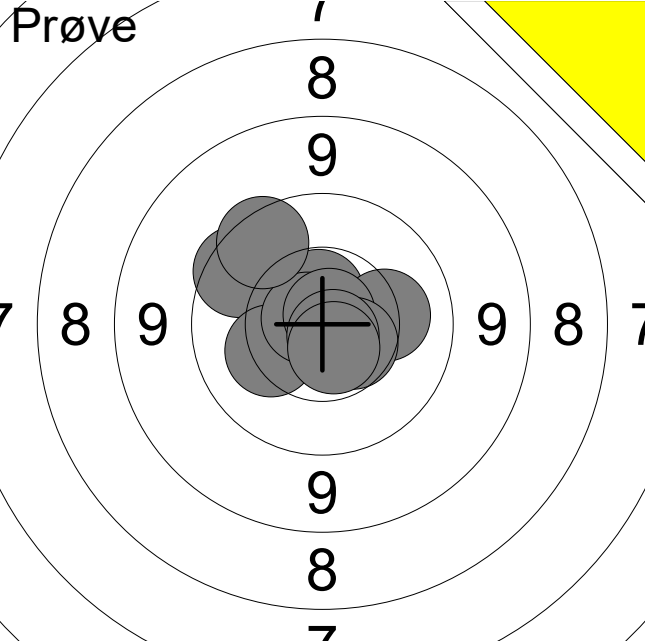
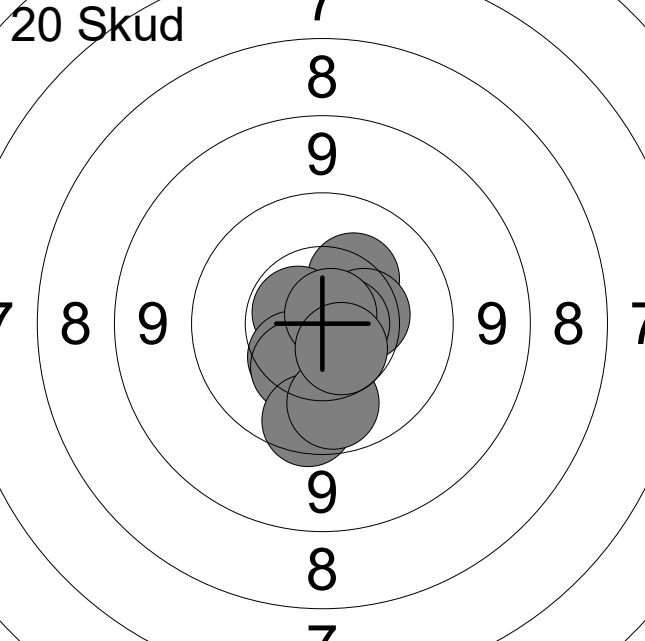
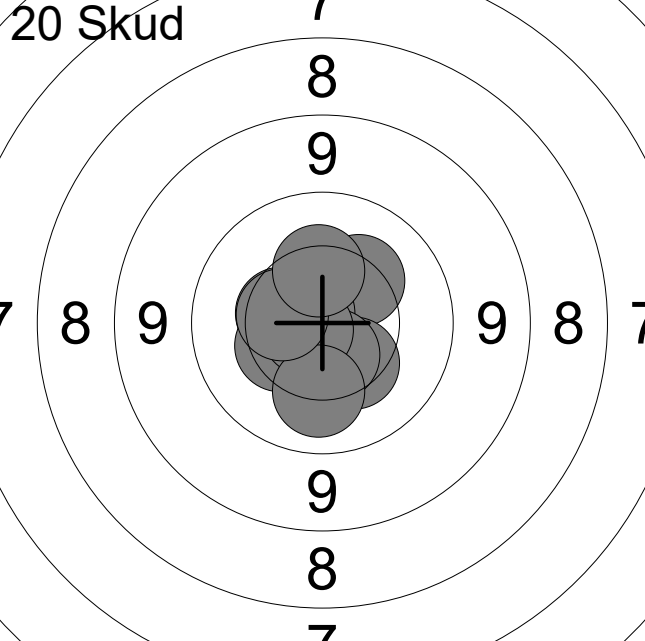
Hold 4	Skive 11	Frida Fertner																																
ØSF		Ganløse Skytteforening		MBK1																														
28.10.2024		Halloween Luftstævne 2024		Ølstykke skytteforening																														
Prøve		<table border="0"> <tr><td>1:</td><td>9.8</td><td>↖</td></tr> <tr><td>2:</td><td>10.6x</td><td>↑</td></tr> <tr><td>3:</td><td>10.3</td><td>↙</td></tr> <tr><td>4:</td><td>10.8x</td><td>↖</td></tr> <tr><td>5:</td><td>9.7</td><td>↗</td></tr> <tr><td>6:</td><td>10.2</td><td>→</td></tr> <tr><td>7:</td><td>10.8x</td><td>↗</td></tr> <tr><td>8:</td><td>10.5</td><td>↘</td></tr> <tr><td>9:</td><td>10.8x</td><td>↘</td></tr> <tr><td>10:</td><td>10.6x</td><td>↓</td></tr> </table>			1:	9.8	↖	2:	10.6x	↑	3:	10.3	↙	4:	10.8x	↖	5:	9.7	↗	6:	10.2	→	7:	10.8x	↗	8:	10.5	↘	9:	10.8x	↘	10:	10.6x	↓
1:	9.8	↖																																
2:	10.6x	↑																																
3:	10.3	↙																																
4:	10.8x	↖																																
5:	9.7	↗																																
6:	10.2	→																																
7:	10.8x	↗																																
8:	10.5	↘																																
9:	10.8x	↘																																
10:	10.6x	↓																																
		Serie 98 (5x)																																
		Total 0 (0x)																																
20 Skud		<table border="0"> <tr><td>1:</td><td>10.3</td><td>↗</td></tr> <tr><td>2:</td><td>10.4</td><td>→</td></tr> <tr><td>3:</td><td>10.6x</td><td>↙</td></tr> <tr><td>4:</td><td>10.4</td><td>↘</td></tr> <tr><td>5:</td><td>10.4</td><td>↘</td></tr> <tr><td>6:</td><td>10.7x</td><td>→</td></tr> <tr><td>7:</td><td>9.8</td><td>↓</td></tr> <tr><td>8:</td><td>10.0</td><td>↓</td></tr> <tr><td>9:</td><td>10.8x</td><td>↗</td></tr> <tr><td>10:</td><td>10.6</td><td>↘</td></tr> </table>			1:	10.3	↗	2:	10.4	→	3:	10.6x	↙	4:	10.4	↘	5:	10.4	↘	6:	10.7x	→	7:	9.8	↓	8:	10.0	↓	9:	10.8x	↗	10:	10.6	↘
1:	10.3	↗																																
2:	10.4	→																																
3:	10.6x	↙																																
4:	10.4	↘																																
5:	10.4	↘																																
6:	10.7x	→																																
7:	9.8	↓																																
8:	10.0	↓																																
9:	10.8x	↗																																
10:	10.6	↘																																
		Serie 99 (3x)																																
		Total 99 (3x)																																
20 Skud		<table border="0"> <tr><td>11:</td><td>10.5</td><td>↙</td></tr> <tr><td>12:</td><td>10.4</td><td>↙</td></tr> <tr><td>13:</td><td>10.3</td><td>↗</td></tr> <tr><td>14:</td><td>10.4</td><td>↘</td></tr> <tr><td>15:</td><td>10.8x</td><td>↗</td></tr> <tr><td>16:</td><td>10.6</td><td>↘</td></tr> <tr><td>17:</td><td>10.8x</td><td>↙</td></tr> <tr><td>18:</td><td>10.1</td><td>↓</td></tr> <tr><td>19:</td><td>10.5</td><td>↙</td></tr> <tr><td>20:</td><td>10.3</td><td>↑</td></tr> </table>			11:	10.5	↙	12:	10.4	↙	13:	10.3	↗	14:	10.4	↘	15:	10.8x	↗	16:	10.6	↘	17:	10.8x	↙	18:	10.1	↓	19:	10.5	↙	20:	10.3	↑
11:	10.5	↙																																
12:	10.4	↙																																
13:	10.3	↗																																
14:	10.4	↘																																
15:	10.8x	↗																																
16:	10.6	↘																																
17:	10.8x	↙																																
18:	10.1	↓																																
19:	10.5	↙																																
20:	10.3	↑																																
		Serie 100 (2x)																																
		Total 199 (5x)																																

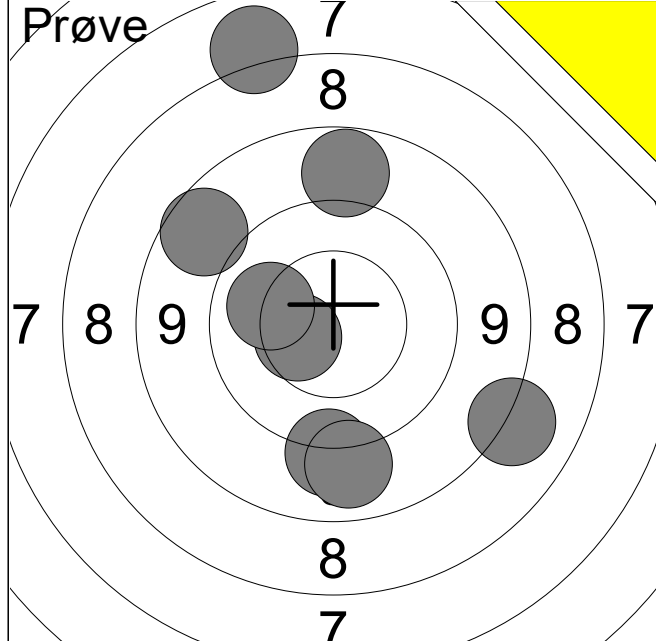

1:	8.3	↘
2:	9.3	↓
3:	7.1	↑
4:	8.9	↗
5:	10.5	←
6:	9.0	↑
7:	9.1	↓
8:	10.1	←
Serie		70 (0x)
Total		0 (0x)

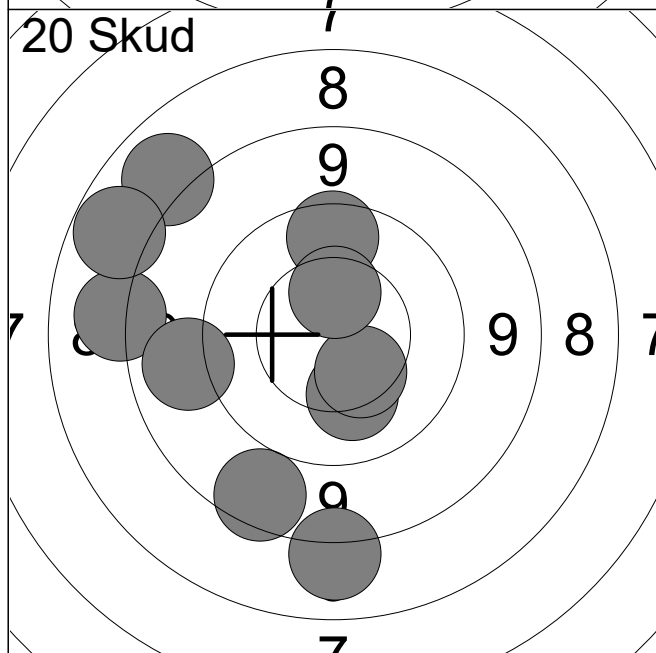

1:	8.1	↗
2:	8.2	↓
3:	8.8	↓
4:	8.3	←
5:	10.2	↓
6:	10.4	↓
7:	9.1	←
8:	9.8	↑
9:	10.4	↑
10:	8.0	↖
Serie		88 (0x)
Total		88 (0x)

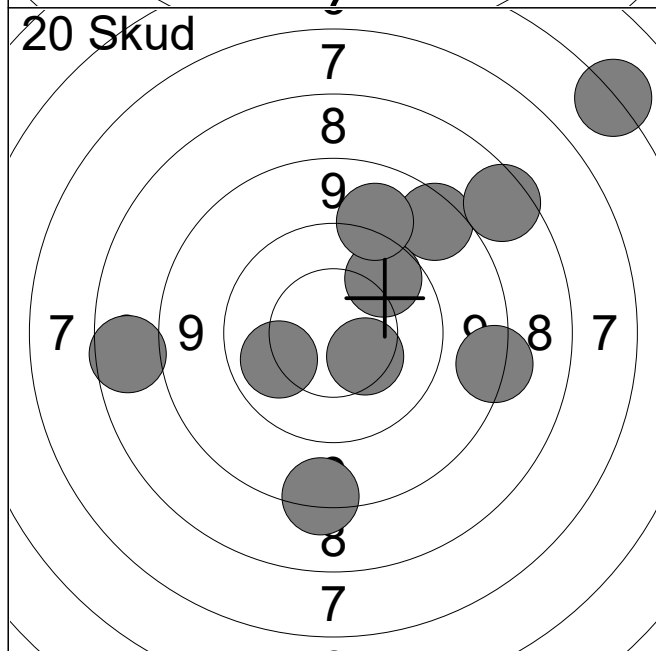

11:	10.1	←
12:	8.7	↗
13:	7.8	↗
14:	10.4	↘
15:	7.9	←
16:	9.9	↗
17:	9.2	↑
18:	5.4	↗
19:	8.5	↓
20:	8.5	→
Serie		81 (0x)
Total		169 (0x)

Hold 5	Skive 2	Ida Lund Nellemann		
ØSF		Ølstykke Skytteforening		Å2
28.10.2024		Halloween Luftstævne 2024		Ølstykke skytteforening
Prøve		1: 8.9 ↗ 2: 8.7 ↗ 3: 6.9 ↗ 4: 9.4 ↑ 5: 9.2 ↗		
		Serie 40 (0x) Total 0 (0x)		
20 Skud		1: 8.3 ↗ 2: 7.7 ↗ 3: 9.2 ↗ 4: 8.8 ↗ 5: 8.0 ↗ 6: 9.2 ← 7: 9.2 ↗ 8: 9.2 ↗ 9: 9.8 ↗ 10: 8.9 ←		
		Serie 84 (0x) Total 84 (0x)		
20 Skud		11: 8.3 ↗ 12: 9.0 ↗ 13: 9.5 ↑ 14: 9.0 ↗ 15: 9.7 ← 16: 10.2 ↑ 17: 10.4 ↗ 18: 9.6 ↗ 19: 10.5 ↗ 20: 10.5 ←		
		Serie 93 (0x) Total 177 (0x)		

Hold 5	Skive 3	Ida Aaslev Noerager Bay		
ØSF		Ølstykke Skytteforening		MJ1
28.10.2024		Halloween Luftstævne 2024		Ølstykke skytteforening
Prøve		1: 10.5 ↘ 2: 9.8 ← 3: 10.7x ↗ 4: 10.4 ↖		
		Serie 39 (1x) Total 0 (0x)		
20 Skud		1: 10.5 ↖ 2: 10.3 → 3: 10.7x ↓ 4: 10.7x ↗ 5: 10.6x ↗ 6: 10.4 ↘ 7: 10.7x → 8: 10.2 ↖ 9: 10.6x ↗ 10: 10.6x ↓		
		Serie 100 (6x) Total 100 (6x)		
20 Skud		11: 10.1 → 12: 10.7x → 13: 10.5 → 14: 10.1 ↗ 15: 10.9x ↗ 16: 10.5 → 17: 10.5 ↓ 18: 10.3 ↗ 19: 10.8x ↗ 20: 10.7x →		
		Serie 100 (4x) Total 200 (10x)		

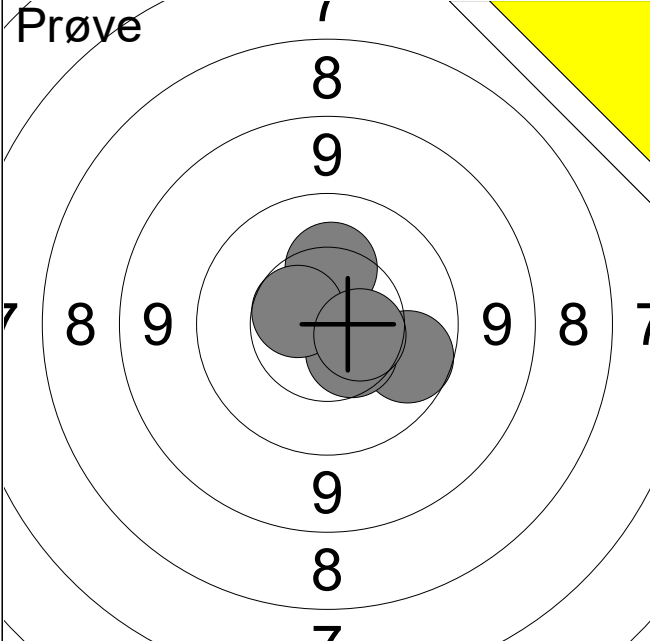
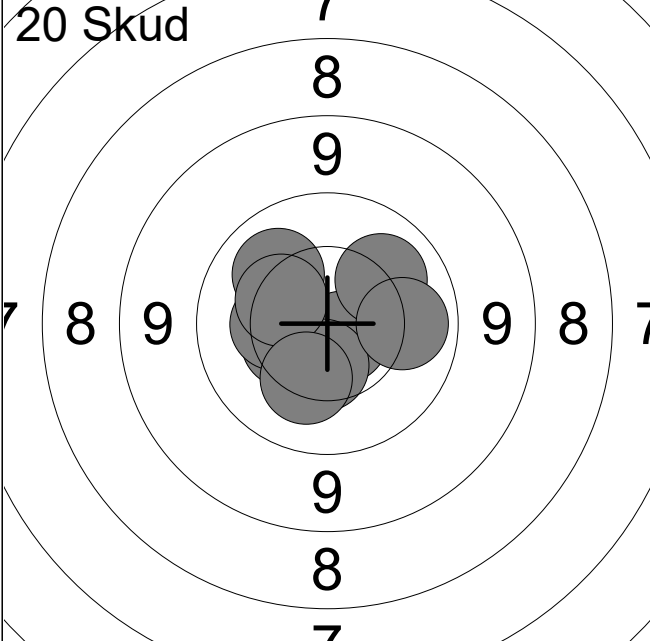
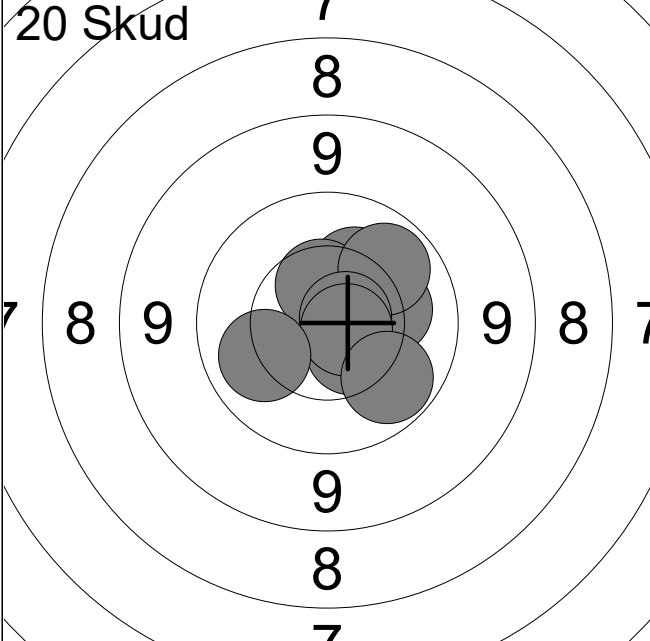
Hold 5	Skive 4	Sara Aaslev Noerager Bay																																
ØSF		Ølstykke Skytteforening		MJ1																														
28.10.2024		Halloween Luftstævne 2024		Ølstykke skytteforening																														
Prøve		<table border="0"> <tr><td>1:</td><td>10.3</td><td>↑</td></tr> <tr><td>2:</td><td>9.9</td><td>→</td></tr> <tr><td>3:</td><td>10.5</td><td>↓</td></tr> <tr><td>4:</td><td>10.6</td><td>↗</td></tr> <tr><td>5:</td><td>10.5</td><td>→</td></tr> </table>			1:	10.3	↑	2:	9.9	→	3:	10.5	↓	4:	10.6	↗	5:	10.5	→															
1:	10.3	↑																																
2:	9.9	→																																
3:	10.5	↓																																
4:	10.6	↗																																
5:	10.5	→																																
		<table border="0"> <tr><td>Serie</td><td colspan="2">49 (0x)</td></tr> <tr><td>Total</td><td colspan="2">0 (0x)</td></tr> </table>			Serie	49 (0x)		Total	0 (0x)																									
Serie	49 (0x)																																	
Total	0 (0x)																																	
20 Skud		<table border="0"> <tr><td>1:</td><td>10.4</td><td>←</td></tr> <tr><td>2:</td><td>10.6x</td><td>↓</td></tr> <tr><td>3:</td><td>10.7x</td><td>↓</td></tr> <tr><td>4:</td><td>10.1</td><td>↗</td></tr> <tr><td>5:</td><td>10.1</td><td>↗</td></tr> <tr><td>6:</td><td>10.3</td><td>←</td></tr> <tr><td>7:</td><td>10.5</td><td>↓</td></tr> <tr><td>8:</td><td>10.1</td><td>→</td></tr> <tr><td>9:</td><td>10.3</td><td>↖</td></tr> <tr><td>10:</td><td>10.3</td><td>↓</td></tr> </table>			1:	10.4	←	2:	10.6x	↓	3:	10.7x	↓	4:	10.1	↗	5:	10.1	↗	6:	10.3	←	7:	10.5	↓	8:	10.1	→	9:	10.3	↖	10:	10.3	↓
1:	10.4	←																																
2:	10.6x	↓																																
3:	10.7x	↓																																
4:	10.1	↗																																
5:	10.1	↗																																
6:	10.3	←																																
7:	10.5	↓																																
8:	10.1	→																																
9:	10.3	↖																																
10:	10.3	↓																																
		<table border="0"> <tr><td>Serie</td><td colspan="2">100 (2x)</td></tr> <tr><td>Total</td><td colspan="2">100 (2x)</td></tr> </table>			Serie	100 (2x)		Total	100 (2x)																									
Serie	100 (2x)																																	
Total	100 (2x)																																	
20 Skud		<table border="0"> <tr><td>11:</td><td>10.5</td><td>↓</td></tr> <tr><td>12:</td><td>10.3</td><td>↗</td></tr> <tr><td>13:</td><td>10.5</td><td>↗</td></tr> <tr><td>14:</td><td>10.5</td><td>↑</td></tr> <tr><td>15:</td><td>10.2</td><td>→</td></tr> <tr><td>16:</td><td>10.0</td><td>↗</td></tr> <tr><td>17:</td><td>10.7x</td><td>→</td></tr> <tr><td>18:</td><td>10.7x</td><td>→</td></tr> <tr><td>19:</td><td>10.1</td><td>←</td></tr> <tr><td>20:</td><td>10.0</td><td>↓</td></tr> </table>			11:	10.5	↓	12:	10.3	↗	13:	10.5	↗	14:	10.5	↑	15:	10.2	→	16:	10.0	↗	17:	10.7x	→	18:	10.7x	→	19:	10.1	←	20:	10.0	↓
11:	10.5	↓																																
12:	10.3	↗																																
13:	10.5	↗																																
14:	10.5	↑																																
15:	10.2	→																																
16:	10.0	↗																																
17:	10.7x	→																																
18:	10.7x	→																																
19:	10.1	←																																
20:	10.0	↓																																
		<table border="0"> <tr><td>Serie</td><td colspan="2">100 (2x)</td></tr> <tr><td>Total</td><td colspan="2">200 (4x)</td></tr> </table>			Serie	100 (2x)		Total	200 (4x)																									
Serie	100 (2x)																																	
Total	200 (4x)																																	

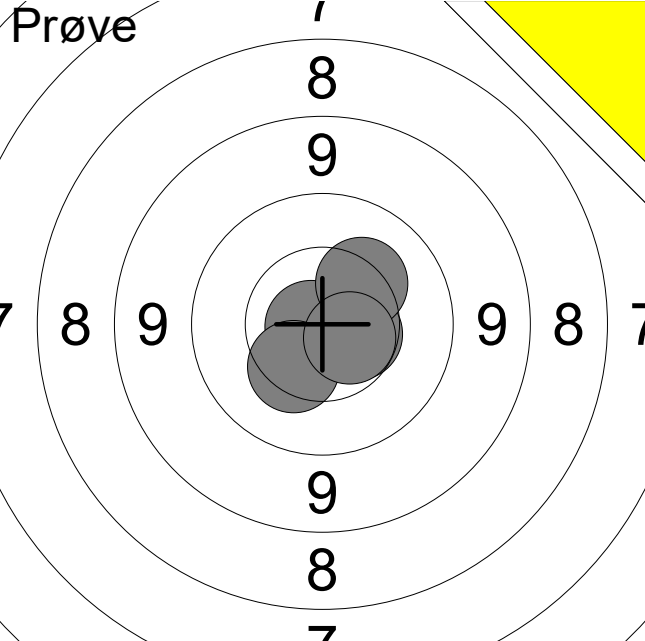
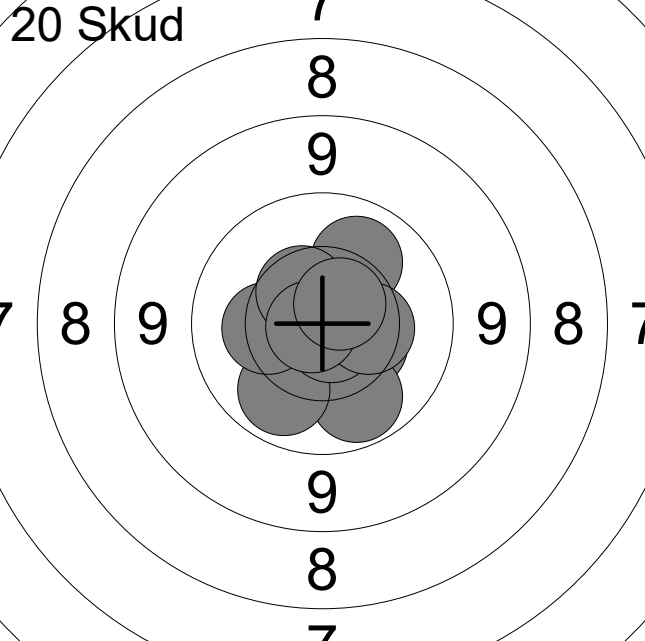
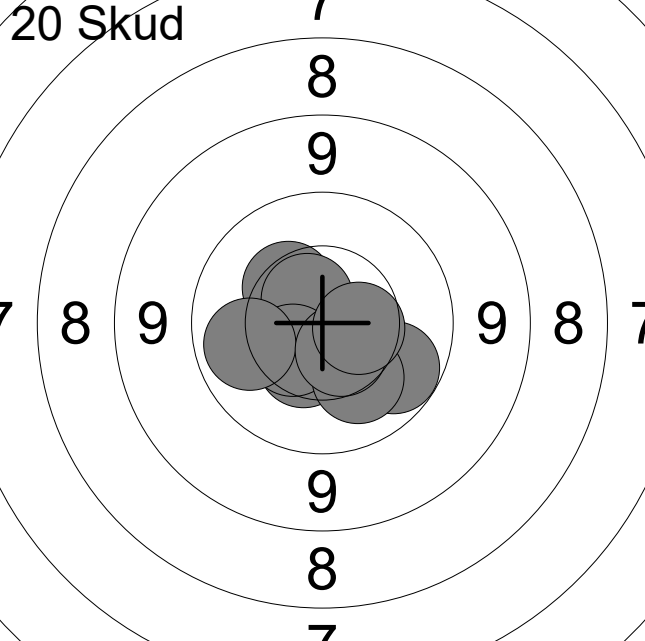
Hold 5	Skive 5	Malou Schmidt-Larsen		
ØSF		Ølstykke Skytteforening		MJ2
28.10.2024		Halloween Luftstævne 2024		Ølstykke skytteforening
Prøve		1: 10.8x ← 2: 10.5 → 3: 10.3 ↗ 4: 10.3 ↓ 5: 10.6x ↘		
		Serie 50 (2x) Total 0 (0x)		
20 Skud		1: 10.4 → 2: 10.0 ↓ 3: 10.1 ↓ 4: 10.8x ↓ 5: 10.1 ↗ 6: 10.4 → 7: 10.3 ← 8: 10.5 ↗ 9: 10.8x ← 10: 10.6x ↗		
		Serie 100 (3x) Total 100 (3x)		
20 Skud		11: 10.4 ↗ 12: 10.6x ↗ 13: 10.5 → 14: 10.0 ↓ 15: 10.4 ↓ 16: 10.5 ↓ 17: 10.1 ← 18: 10.2 ↓ 19: 10.6 ↓ 20: 10.5 →		
		Serie 100 (1x) Total 200 (4x)		

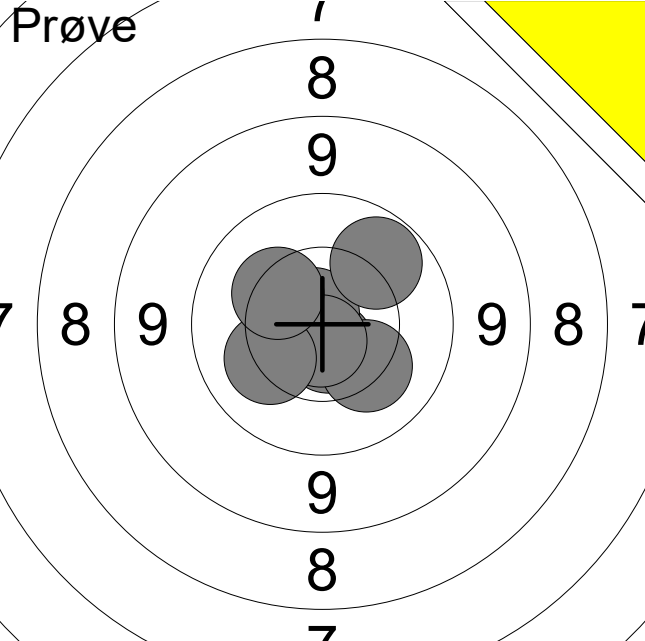
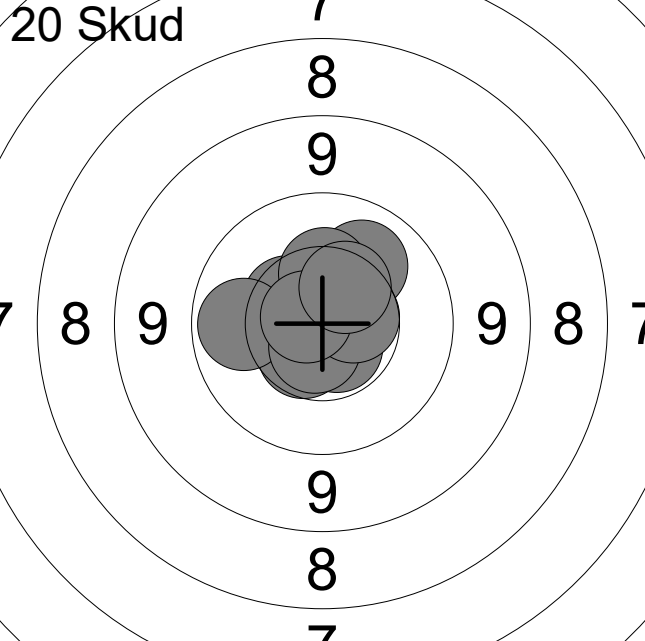
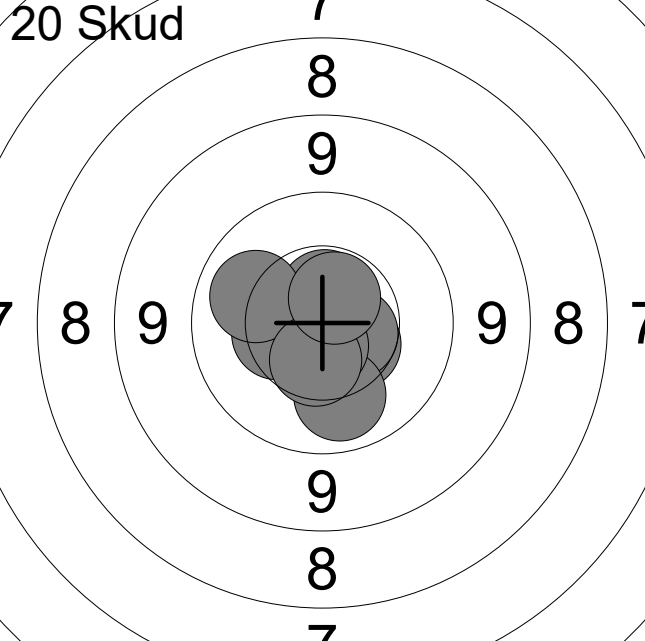
Hold	Skive	Magnus Bjoernberg Levisen		
5	6	ØSF	Ølstykke Skytteforening	MJ2
28.10.2024	Halloween Luftstævne 2024	Ølstykke skytteforening		
Prøve		1:	10.7x	↘
		2:	10.8x	↗
		3:	10.2	↘
		4:	10.8x	↓
		5:	10.0	↗
		6:	10.2	↖
		7:	10.3	↖
		Serie		70 (3x)
		Total		0 (0x)
20 Skud		1:	10.5	↘
		2:	10.1	↗
		3:	10.6x	↘
		4:	10.5	↗
		5:	10.4	↑
		6:	10.0	↖
		7:	10.7x	↘
		8:	10.6	→
		9:	10.7x	↖
		10:	10.4	↗
		Serie		100 (3x)
		Total		100 (3x)
20 Skud		11:	10.8x	↗
		12:	10.6x	↑
		13:	10.5	↘
		14:	10.6	→
		15:	10.1	↓
		16:	10.7x	↓
		17:	10.4	↖
		18:	10.1	↖
		19:	10.5	↓
		20:	10.6x	↗
		Serie		100 (4x)
		Total		200 (7x)

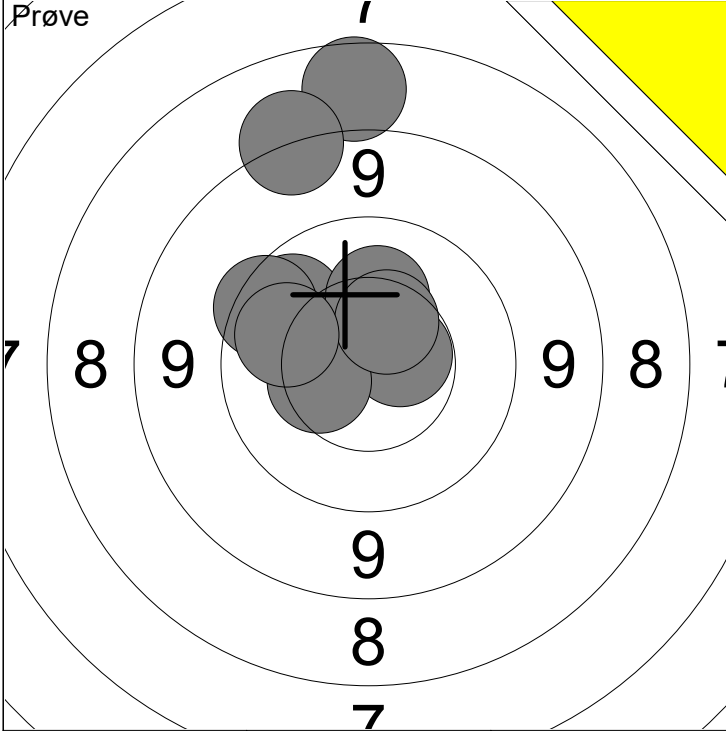

1: 7.9 ↑	6: 10.6x →	Serie	93 (1x)
2: 8.3 ↑	7: 10.2 ↑		
3: 9.9 ↗	8: 10.4 ←	Total	0 (0x)
4: 9.7 ↗	9: 10.5 ↗		
5: 10.5 ↗	10: 10.0 ←		

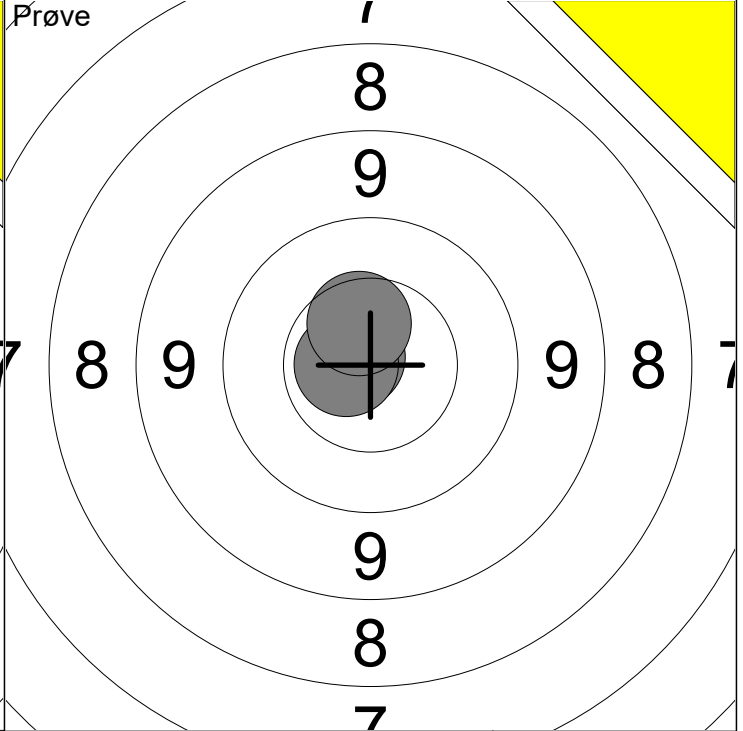

11: 10.7x ←	Serie	30 (2x)
12: 10.7x ←		
13: 10.5 ↑	Total	0 (0x)

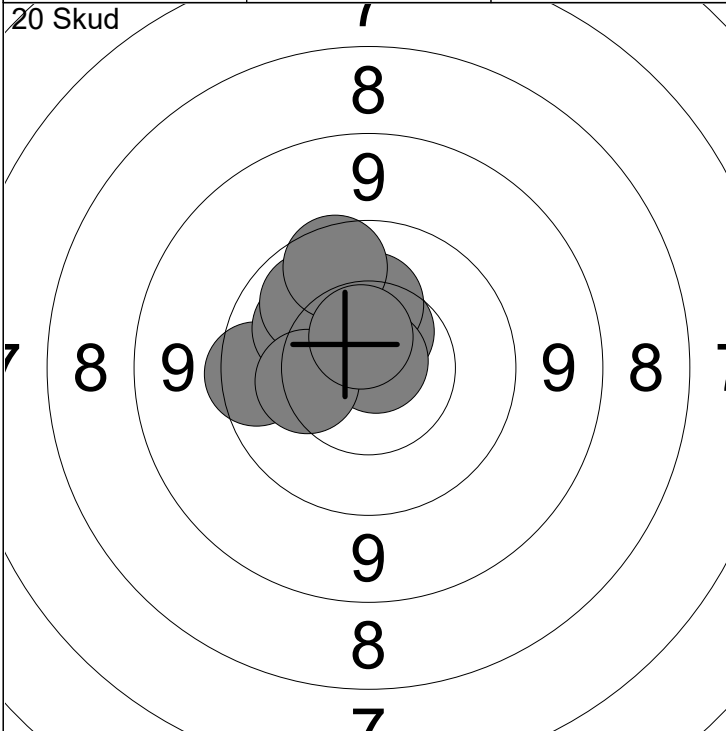

1: 9.8 ←	6: 10.8x ↗	Serie	98 (2x)
2: 10.3 ↑	7: 10.1 ↘		
3: 10.5 ↑	8: 10.3 ←	Total	98 (2x)
4: 10.3 ↑	9: 9.8 ↗		
5: 10.2 ↖	10: 10.6x ↗		

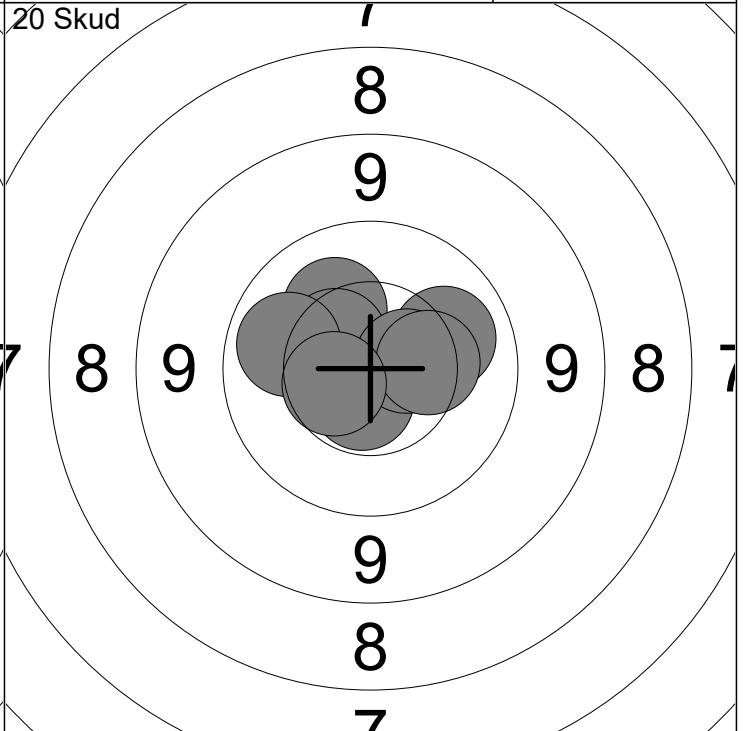

11: 10.8x ←	Serie	100 (3x)
12: 10.2 ↗		
13: 10.8x ↖	Total	198 (5x)
14: 10.6x ↓		
15: 10.5 ↖		

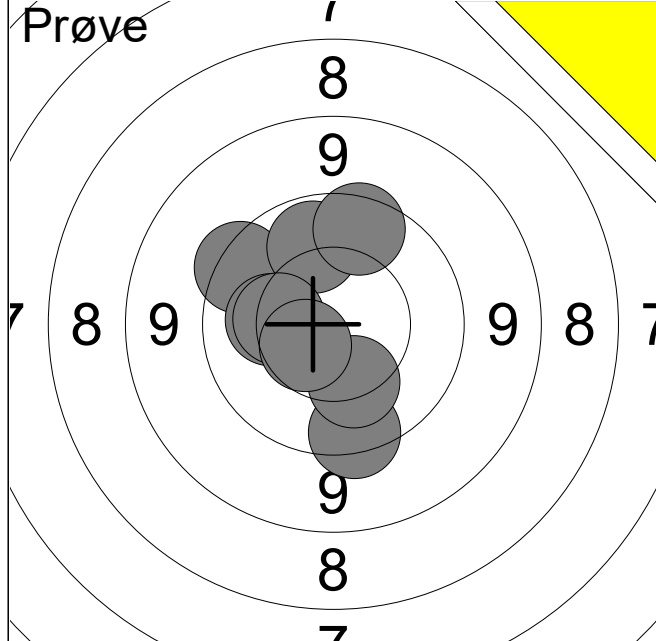

1:	9.6	↓
2:	10.2	↓
3:	9.6	↗
4:	10.0	↑
5:	10.2	←
6:	10.3	←
7:	9.8	↑
8:	10.5	↙
Serie		77 (0x)
Total		0 (0x)

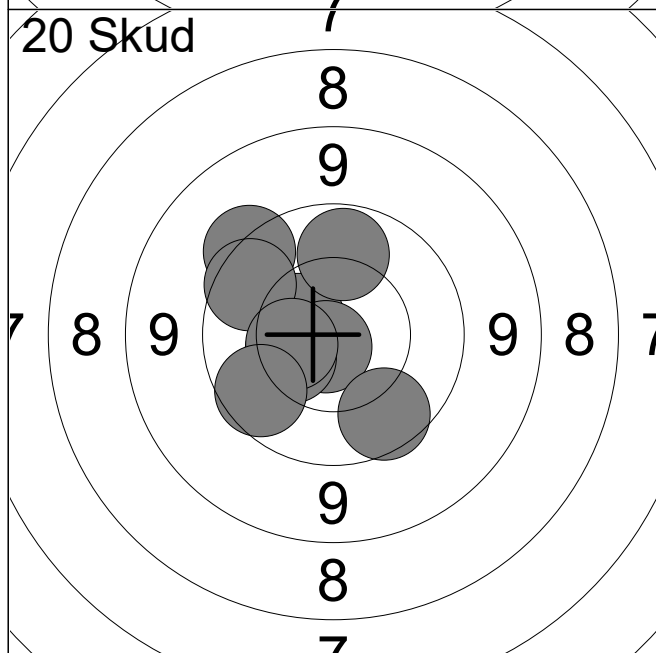

1:	10.4	←
2:	10.5	↖
3:	9.5	↗
4:	9.8	↗
5:	10.8x	↙
6:	10.4	←
7:	10.0	↑
8:	10.4	←
9:	9.9	↙
10:	9.8	↘
Serie		96 (1x)
Total		96 (1x)

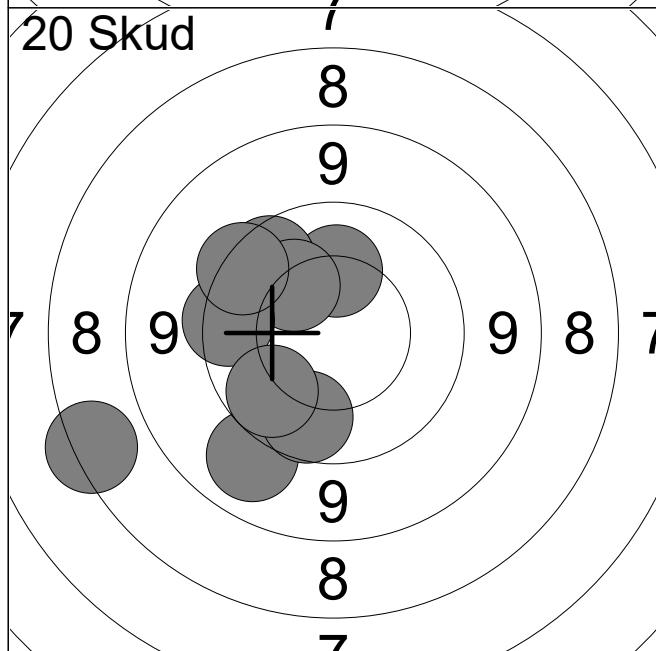

11:	10.2	↑
12:	9.8	↗
13:	9.1	↙
14:	9.8	↗
15:	10.2	↗
16:	9.9	↙
17:	9.7	←
18:	10.0	↙
19:	9.6	↗
20:	7.6	←
Serie		91 (0x)
Total		187 (1x)

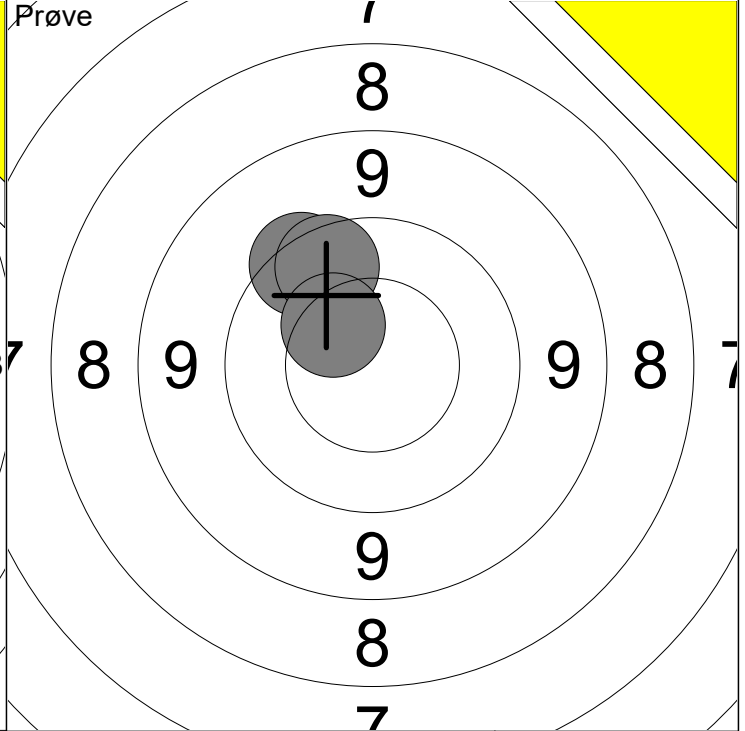
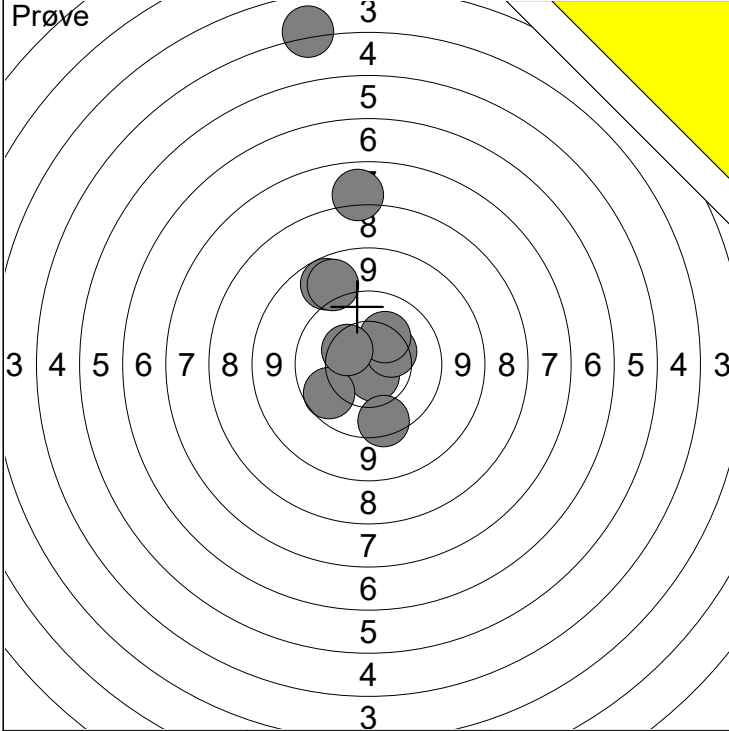

1: 3.2 ↑	6: 9.9 ↙	Serie 86 (1x)
2: 7.1 ↑	7: 9.7 ↓	
3: 9.0 ↖	8: 10.4 ↗	Total 0 (0x)
4: 9.0 ↖	9: 10.3 ↗	
5: 10.7x ↓	10: 10.4 ↖	

11: 9.6 ↖	Serie 28 (0x)
12: 9.8 ↖	
13: 10.4 ↖	Total 0 (0x)

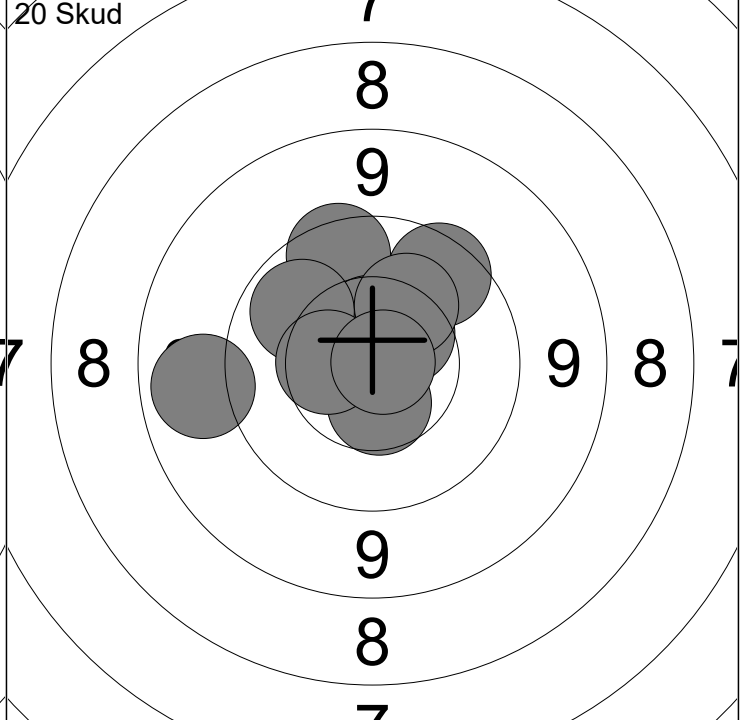
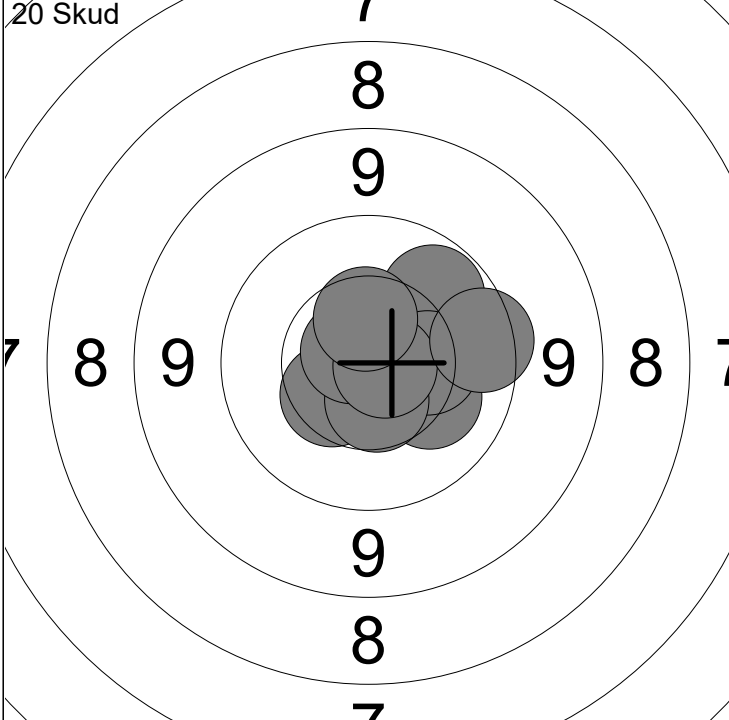

1: 10.2 →	6: 10.6 ↓	Serie 99 (2x)
2: 10.4 ↙	7: 10.7x ↖	
3: 10.1 →	8: 10.8x →	Total 99 (2x)
4: 10.0 ↗	9: 10.5 ↑	
5: 10.3 →	10: 9.7 →	

11: 9.7 ↖	16: 10.0 ↖	Serie 97 (1x)
12: 9.8 ↗	17: 10.5 ←	
13: 10.6 ↑	18: 9.1 ←	Total 196 (3x)
14: 10.5 ↓	19: 10.2 ↗	
15: 10.5 ↗	20: 10.8x →	

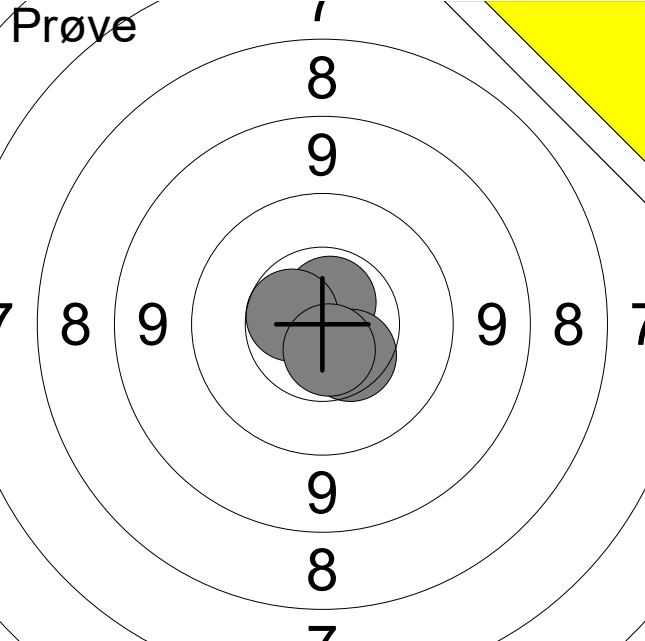
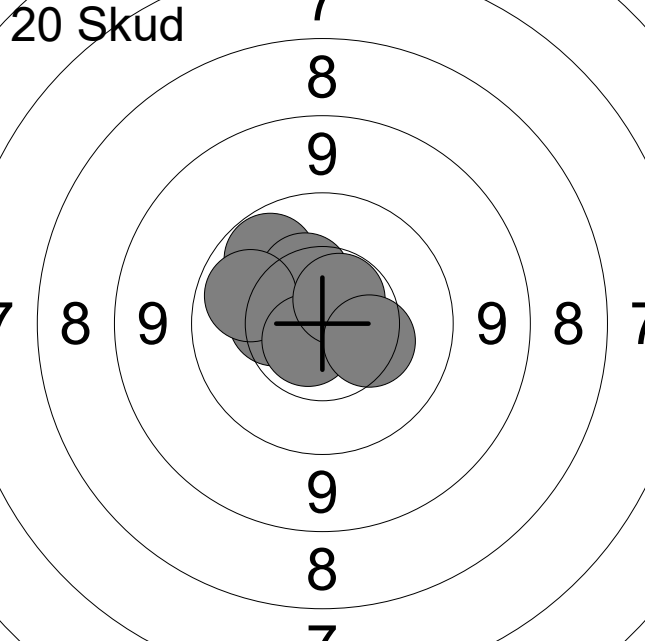
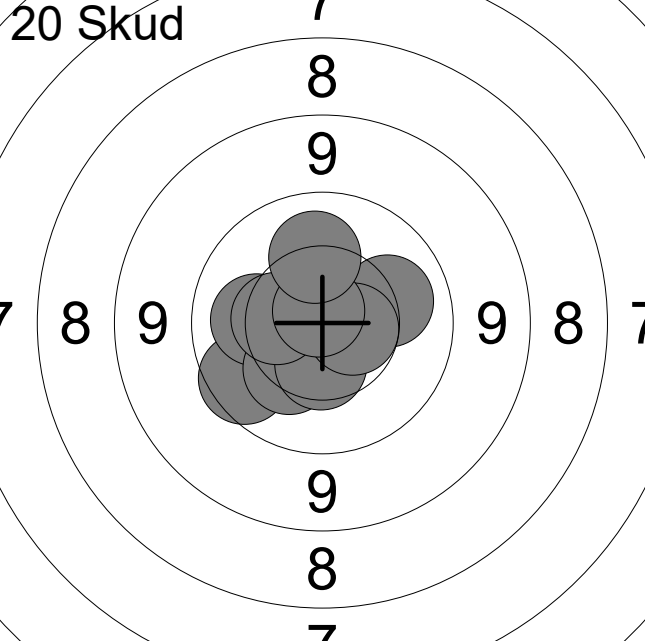
Hold 5	Skive 10	Alexander Middelboe		
ØSF		Ganløse Skytteforening		MBK1
28.10.2024		Halloween Luftstævne 2024		Ølstykke skytteforening
Prøve		1: 10.9x ↗ 2: 10.7x ↗ 3: 10.6 ↖ 4: 10.5 ↘ 5: 10.6x ↘		
		Serie 50 (3x) Total 0 (0x)		
20 Skud		1: 10.8x → 2: 10.8x → 3: 10.0 ↗ 4: 10.4 ← 5: 10.7x ↗ 6: 10.4 ↗ 7: 10.0 ↖ 8: 10.7x ↘ 9: 10.6x ↗ 10: 10.4 →		
		Serie 100 (5x) Total 100 (5x)		
20 Skud		11: 9.8 ↙ 12: 10.7x ↙ 13: 10.2 ← 14: 10.3 ↘ 15: 10.5 ↓ 16: 10.4 ← 17: 10.1 → 18: 10.6 → 19: 10.8x ↗ 20: 10.2 ↗		
		Serie 99 (2x) Total 199 (7x)		

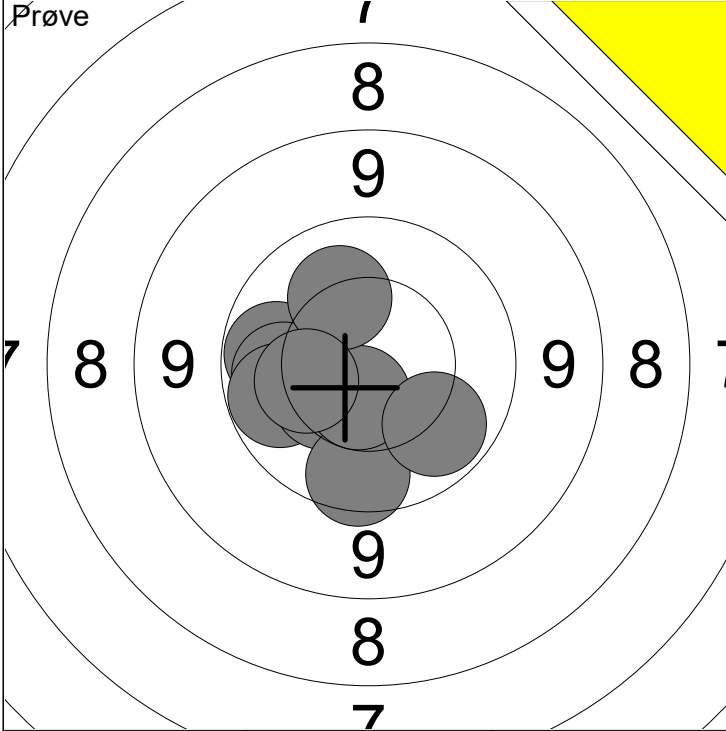

1: 10.0 ←	6: 9.8 ↓	Serie	99 (0x)
2: 10.1 ←	7: 10.6 ↓		
3: 10.5 ↓	8: 10.0 ↘	Total	0 (0x)
4: 10.0 ←	9: 10.2 ↗		
5: 10.4 ↙	10: 10.3 ←		

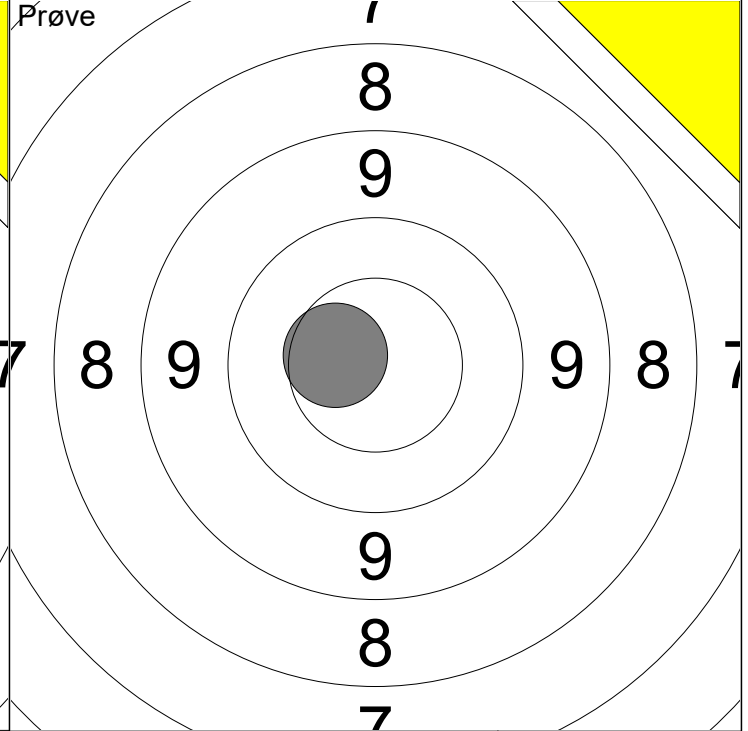

11: 10.5 ←	Serie	10 (0x)
	Total	0 (0x)

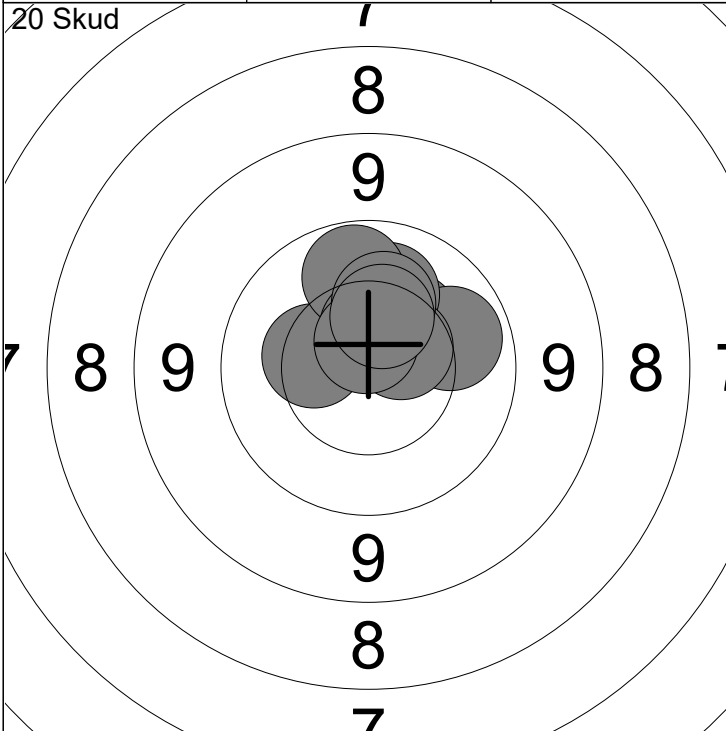

1: 10.4 ←	6: 10.0 ↑	Serie	100 (1x)
2: 10.3 ↗	7: 10.5 ↑		
3: 10.0 →	8: 10.3 ↑	Total	100 (1x)
4: 10.2 ↑	9: 10.7x ↑		
5: 10.6 ↗	10: 10.4 ↑		

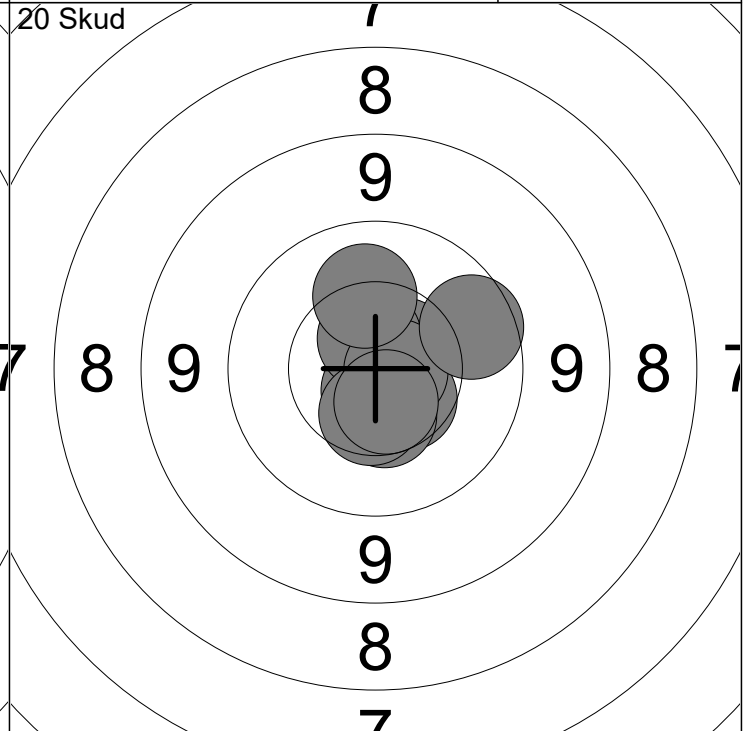

11: 10.6x ↗	16: 10.5 ↓	Serie	99 (4x)
12: 10.5 ↘	17: 10.7x →		
13: 10.7x ↓	18: 9.8 →	Total	199 (5x)
14: 10.4 ↓	19: 10.2 ↑		
15: 10.6x ↑	20: 10.6 ↓		

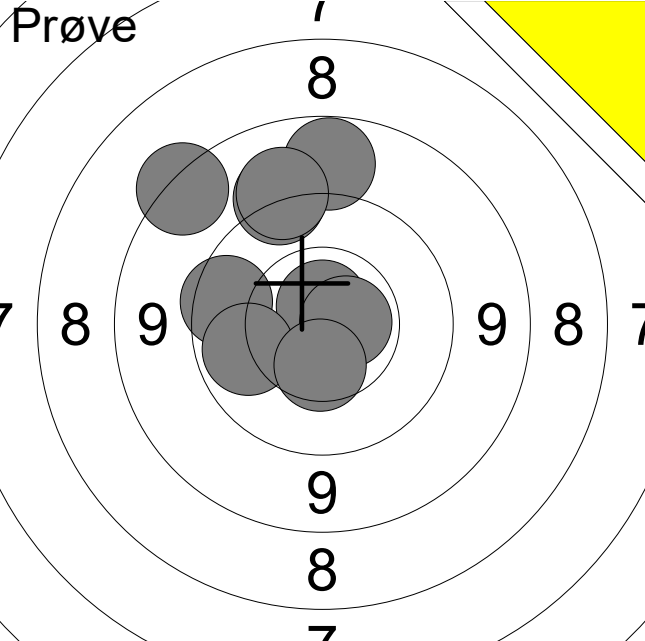
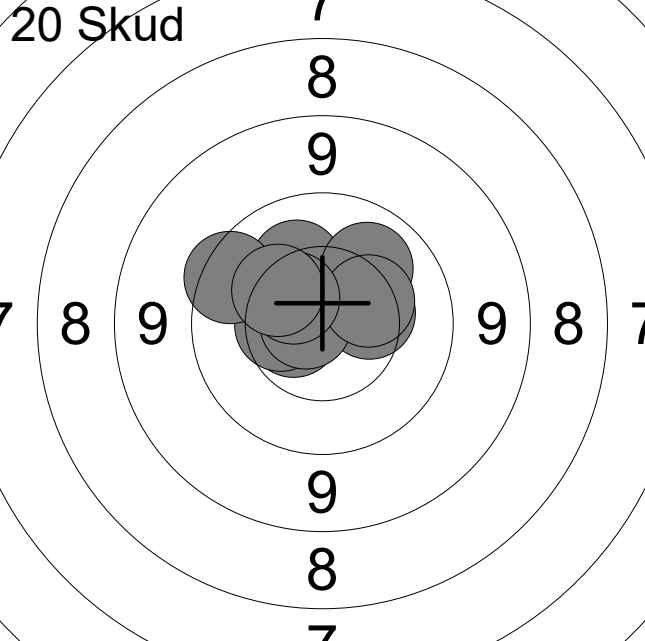
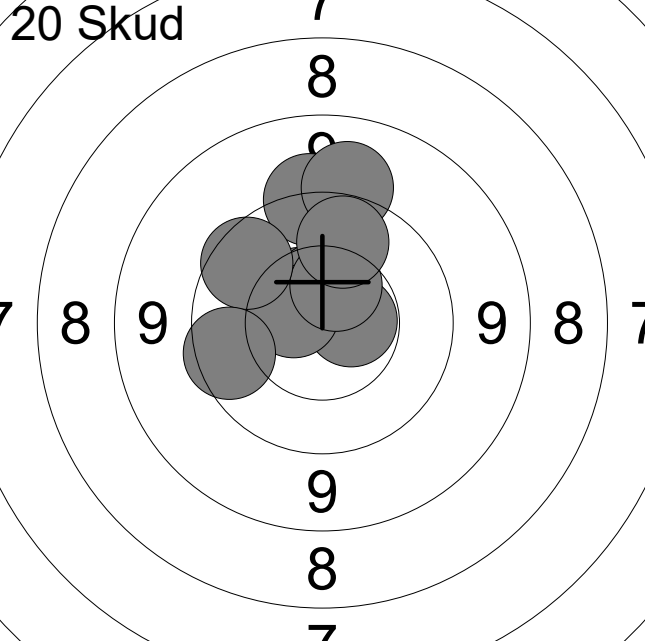
Hold 6	Skive 2	Mikkel Kannik																																
ØSF		Ølstykke Skytteforening		ST2																														
28.10.2024		Halloween Luftstævne 2024		Ølstykke skytteforening																														
Prøve		<table border="0"> <tr><td>1:</td><td>10.7x</td><td>↑</td></tr> <tr><td>2:</td><td>9.3</td><td>↑</td></tr> <tr><td>3:</td><td>8.5</td><td>↗</td></tr> <tr><td>4:</td><td>9.0</td><td>↑</td></tr> <tr><td>5:</td><td>9.3</td><td>↑</td></tr> <tr><td>6:</td><td>9.8</td><td>←</td></tr> <tr><td>7:</td><td>10.0</td><td>←</td></tr> <tr><td>8:</td><td>10.7x</td><td>→</td></tr> <tr><td>9:</td><td>10.5</td><td>↓</td></tr> </table>			1:	10.7x	↑	2:	9.3	↑	3:	8.5	↗	4:	9.0	↑	5:	9.3	↑	6:	9.8	←	7:	10.0	←	8:	10.7x	→	9:	10.5	↓			
1:	10.7x	↑																																
2:	9.3	↑																																
3:	8.5	↗																																
4:	9.0	↑																																
5:	9.3	↑																																
6:	9.8	←																																
7:	10.0	←																																
8:	10.7x	→																																
9:	10.5	↓																																
		Serie 84 (2x)																																
		Total 0 (0x)																																
20 Skud		<table border="0"> <tr><td>1:</td><td>10.6x</td><td>←</td></tr> <tr><td>2:</td><td>10.2</td><td>↑</td></tr> <tr><td>3:</td><td>10.5</td><td>←</td></tr> <tr><td>4:</td><td>10.4</td><td>→</td></tr> <tr><td>5:</td><td>9.7</td><td>↖</td></tr> <tr><td>6:</td><td>10.1</td><td>↗</td></tr> <tr><td>7:</td><td>10.8x</td><td>←</td></tr> <tr><td>8:</td><td>10.3</td><td>↗</td></tr> <tr><td>9:</td><td>10.5</td><td>↗</td></tr> <tr><td>10:</td><td>10.3</td><td>↖</td></tr> </table>			1:	10.6x	←	2:	10.2	↑	3:	10.5	←	4:	10.4	→	5:	9.7	↖	6:	10.1	↗	7:	10.8x	←	8:	10.3	↗	9:	10.5	↗	10:	10.3	↖
1:	10.6x	←																																
2:	10.2	↑																																
3:	10.5	←																																
4:	10.4	→																																
5:	9.7	↖																																
6:	10.1	↗																																
7:	10.8x	←																																
8:	10.3	↗																																
9:	10.5	↗																																
10:	10.3	↖																																
		Serie 99 (2x)																																
		Total 99 (2x)																																
20 Skud		<table border="0"> <tr><td>11:</td><td>9.4</td><td>↑</td></tr> <tr><td>12:</td><td>10.6x</td><td>→</td></tr> <tr><td>13:</td><td>9.3</td><td>↑</td></tr> <tr><td>14:</td><td>10.5</td><td>↗</td></tr> <tr><td>15:</td><td>10.5</td><td>↑</td></tr> <tr><td>16:</td><td>10.6x</td><td>←</td></tr> <tr><td>17:</td><td>10.5</td><td>↑</td></tr> <tr><td>18:</td><td>9.8</td><td>↖</td></tr> <tr><td>19:</td><td>9.8</td><td>←</td></tr> <tr><td>20:</td><td>10.0</td><td>↑</td></tr> </table>			11:	9.4	↑	12:	10.6x	→	13:	9.3	↑	14:	10.5	↗	15:	10.5	↑	16:	10.6x	←	17:	10.5	↑	18:	9.8	↖	19:	9.8	←	20:	10.0	↑
11:	9.4	↑																																
12:	10.6x	→																																
13:	9.3	↑																																
14:	10.5	↗																																
15:	10.5	↑																																
16:	10.6x	←																																
17:	10.5	↑																																
18:	9.8	↖																																
19:	9.8	←																																
20:	10.0	↑																																
		Serie 96 (2x)																																
		Total 195 (4x)																																

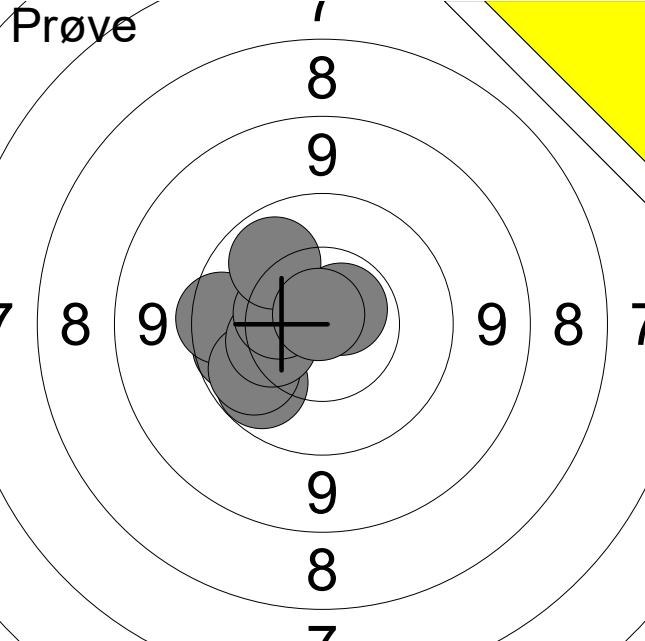
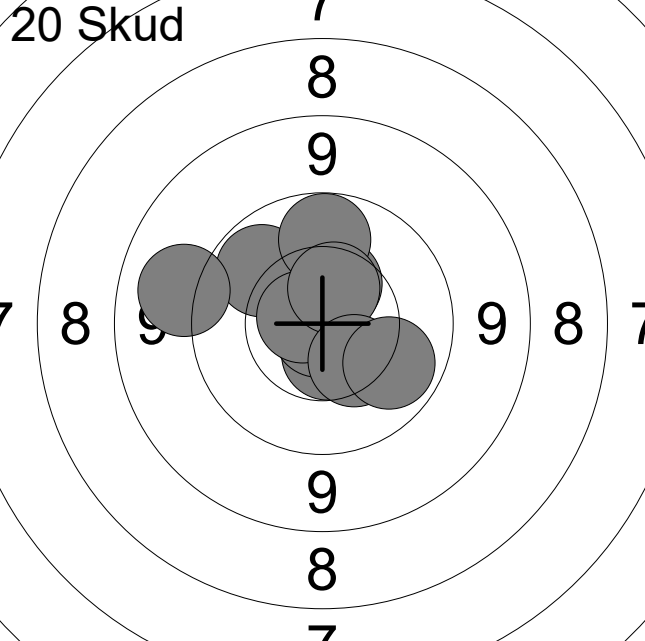
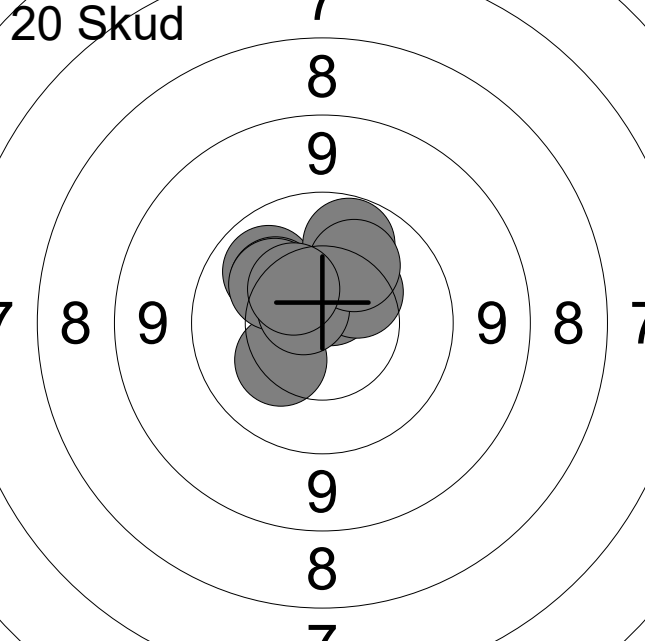
Hold 6	Skive 4	Peter Hansen																																
ØSF		Ballerup Skytteforening		SE1																														
28.10.2024		Halloween Luftstævne 2024		Ølstykke skytteforening																														
Prøve		<table border="0"> <tr><td>1:</td><td>10.0</td><td>↘</td></tr> <tr><td>2:</td><td>9.9</td><td>←</td></tr> <tr><td>3:</td><td>9.7</td><td>←</td></tr> <tr><td>4:</td><td>10.0</td><td>↘</td></tr> <tr><td>5:</td><td>10.3</td><td>←</td></tr> <tr><td>6:</td><td>10.4</td><td>←</td></tr> <tr><td>7:</td><td>10.0</td><td>↗</td></tr> <tr><td>8:</td><td>10.7x</td><td>↗</td></tr> <tr><td>9:</td><td>10.8x</td><td>↗</td></tr> </table>			1:	10.0	↘	2:	9.9	←	3:	9.7	←	4:	10.0	↘	5:	10.3	←	6:	10.4	←	7:	10.0	↗	8:	10.7x	↗	9:	10.8x	↗			
1:	10.0	↘																																
2:	9.9	←																																
3:	9.7	←																																
4:	10.0	↘																																
5:	10.3	←																																
6:	10.4	←																																
7:	10.0	↗																																
8:	10.7x	↗																																
9:	10.8x	↗																																
		Serie 88 (2x)																																
		Total 0 (0x)																																
20 Skud		<table border="0"> <tr><td>1:</td><td>10.4</td><td>↗</td></tr> <tr><td>2:</td><td>10.6</td><td>↓</td></tr> <tr><td>3:</td><td>10.0</td><td>↗</td></tr> <tr><td>4:</td><td>10.8x</td><td>↘</td></tr> <tr><td>5:</td><td>10.0</td><td>↑</td></tr> <tr><td>6:</td><td>10.7x</td><td>←</td></tr> <tr><td>7:</td><td>9.2</td><td>←</td></tr> <tr><td>8:</td><td>10.5</td><td>↑</td></tr> <tr><td>9:</td><td>10.4</td><td>↘</td></tr> <tr><td>10:</td><td>10.0</td><td>↘</td></tr> </table>			1:	10.4	↗	2:	10.6	↓	3:	10.0	↗	4:	10.8x	↘	5:	10.0	↑	6:	10.7x	←	7:	9.2	←	8:	10.5	↑	9:	10.4	↘	10:	10.0	↘
1:	10.4	↗																																
2:	10.6	↓																																
3:	10.0	↗																																
4:	10.8x	↘																																
5:	10.0	↑																																
6:	10.7x	←																																
7:	9.2	←																																
8:	10.5	↑																																
9:	10.4	↘																																
10:	10.0	↘																																
		Serie 99 (2x)																																
		Total 99 (2x)																																
20 Skud		<table border="0"> <tr><td>11:</td><td>10.7x</td><td>↗</td></tr> <tr><td>12:</td><td>10.1</td><td>↗</td></tr> <tr><td>13:</td><td>10.3</td><td>↘</td></tr> <tr><td>14:</td><td>10.2</td><td>↗</td></tr> <tr><td>15:</td><td>10.2</td><td>↗</td></tr> <tr><td>16:</td><td>10.4</td><td>↗</td></tr> <tr><td>17:</td><td>10.7x</td><td>↗</td></tr> <tr><td>18:</td><td>10.0</td><td>↑</td></tr> <tr><td>19:</td><td>10.2</td><td>↗</td></tr> <tr><td>20:</td><td>10.4</td><td>↗</td></tr> </table>			11:	10.7x	↗	12:	10.1	↗	13:	10.3	↘	14:	10.2	↗	15:	10.2	↗	16:	10.4	↗	17:	10.7x	↗	18:	10.0	↑	19:	10.2	↗	20:	10.4	↗
11:	10.7x	↗																																
12:	10.1	↗																																
13:	10.3	↘																																
14:	10.2	↗																																
15:	10.2	↗																																
16:	10.4	↗																																
17:	10.7x	↗																																
18:	10.0	↑																																
19:	10.2	↗																																
20:	10.4	↗																																
		Serie 100 (2x)																																
		Total 199 (4x)																																

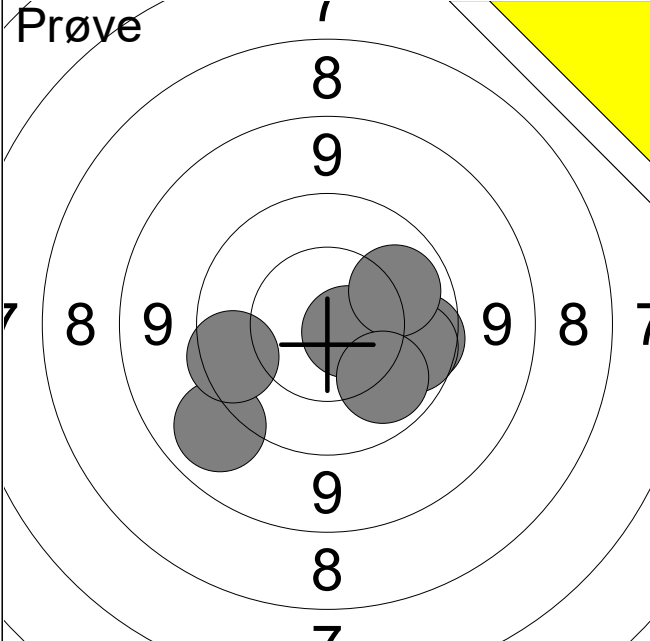
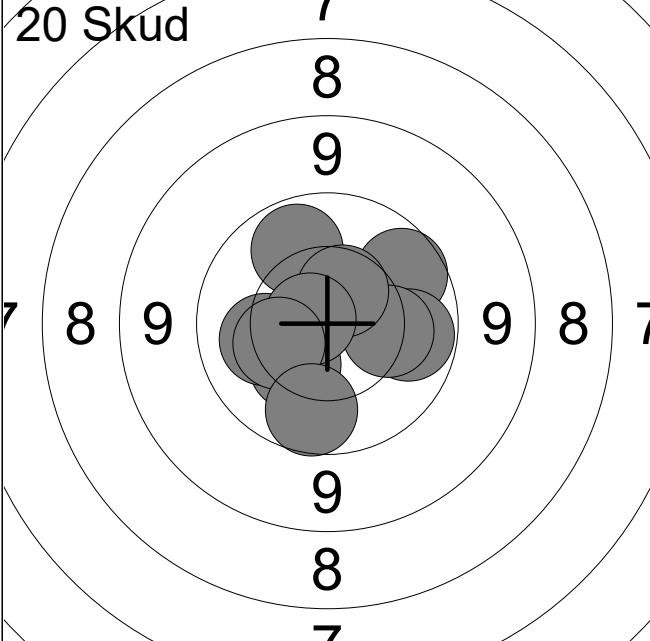
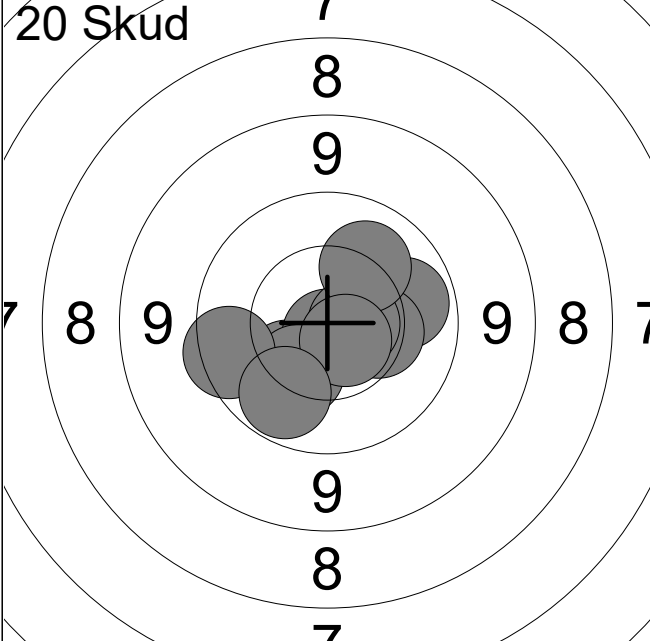
Hold 6	Skive 6	Laura Daugaard Thomsen																																
ØSF		Ølstykke Skytteforening		FRI2																														
28.10.2024		Halloween Luftstævne 2024		Ølstykke skytteforening																														
Prøve		<table border="0"> <tr><td>1:</td><td>9.1</td><td>↙</td></tr> <tr><td>2:</td><td>9.8</td><td>←</td></tr> <tr><td>3:</td><td>9.9</td><td>→</td></tr> <tr><td>4:</td><td>9.9</td><td>→</td></tr> <tr><td>5:</td><td>10.7x</td><td>→</td></tr> <tr><td>6:</td><td>10.1</td><td>↗</td></tr> <tr><td>7:</td><td>10.0</td><td>↘</td></tr> </table>			1:	9.1	↙	2:	9.8	←	3:	9.9	→	4:	9.9	→	5:	10.7x	→	6:	10.1	↗	7:	10.0	↘									
1:	9.1	↙																																
2:	9.8	←																																
3:	9.9	→																																
4:	9.9	→																																
5:	10.7x	→																																
6:	10.1	↗																																
7:	10.0	↘																																
		<table border="0"> <tr><td>Serie</td><td colspan="2">66 (1x)</td></tr> <tr><td>Total</td><td colspan="2">0 (0x)</td></tr> </table>			Serie	66 (1x)		Total	0 (0x)																									
Serie	66 (1x)																																	
Total	0 (0x)																																	
20 Skud		<table border="0"> <tr><td>1:</td><td>10.3</td><td>↙</td></tr> <tr><td>2:</td><td>10.2</td><td>←</td></tr> <tr><td>3:</td><td>9.9</td><td>↗</td></tr> <tr><td>4:</td><td>10.0</td><td>→</td></tr> <tr><td>5:</td><td>10.0</td><td>↑</td></tr> <tr><td>6:</td><td>10.2</td><td>→</td></tr> <tr><td>7:</td><td>10.5</td><td>↗</td></tr> <tr><td>8:</td><td>10.7x</td><td>←</td></tr> <tr><td>9:</td><td>10.3</td><td>←</td></tr> <tr><td>10:</td><td>9.9</td><td>↓</td></tr> </table>			1:	10.3	↙	2:	10.2	←	3:	9.9	↗	4:	10.0	→	5:	10.0	↑	6:	10.2	→	7:	10.5	↗	8:	10.7x	←	9:	10.3	←	10:	9.9	↓
1:	10.3	↙																																
2:	10.2	←																																
3:	9.9	↗																																
4:	10.0	→																																
5:	10.0	↑																																
6:	10.2	→																																
7:	10.5	↗																																
8:	10.7x	←																																
9:	10.3	←																																
10:	9.9	↓																																
		<table border="0"> <tr><td>Serie</td><td colspan="2">98 (1x)</td></tr> <tr><td>Total</td><td colspan="2">98 (1x)</td></tr> </table>			Serie	98 (1x)		Total	98 (1x)																									
Serie	98 (1x)																																	
Total	98 (1x)																																	
20 Skud		<table border="0"> <tr><td>11:</td><td>10.3</td><td>↙</td></tr> <tr><td>12:</td><td>10.0</td><td>→</td></tr> <tr><td>13:</td><td>10.3</td><td>→</td></tr> <tr><td>14:</td><td>10.8x</td><td>↓</td></tr> <tr><td>15:</td><td>10.3</td><td>↙</td></tr> <tr><td>16:</td><td>9.7</td><td>←</td></tr> <tr><td>17:</td><td>10.6x</td><td>→</td></tr> <tr><td>18:</td><td>10.2</td><td>↗</td></tr> <tr><td>19:</td><td>10.7x</td><td>↘</td></tr> <tr><td>20:</td><td>10.0</td><td>↙</td></tr> </table>			11:	10.3	↙	12:	10.0	→	13:	10.3	→	14:	10.8x	↓	15:	10.3	↙	16:	9.7	←	17:	10.6x	→	18:	10.2	↗	19:	10.7x	↘	20:	10.0	↙
11:	10.3	↙																																
12:	10.0	→																																
13:	10.3	→																																
14:	10.8x	↓																																
15:	10.3	↙																																
16:	9.7	←																																
17:	10.6x	→																																
18:	10.2	↗																																
19:	10.7x	↘																																
20:	10.0	↙																																
		<table border="0"> <tr><td>Serie</td><td colspan="2">99 (3x)</td></tr> <tr><td>Total</td><td colspan="2">197 (4x)</td></tr> </table>			Serie	99 (3x)		Total	197 (4x)																									
Serie	99 (3x)																																	
Total	197 (4x)																																	

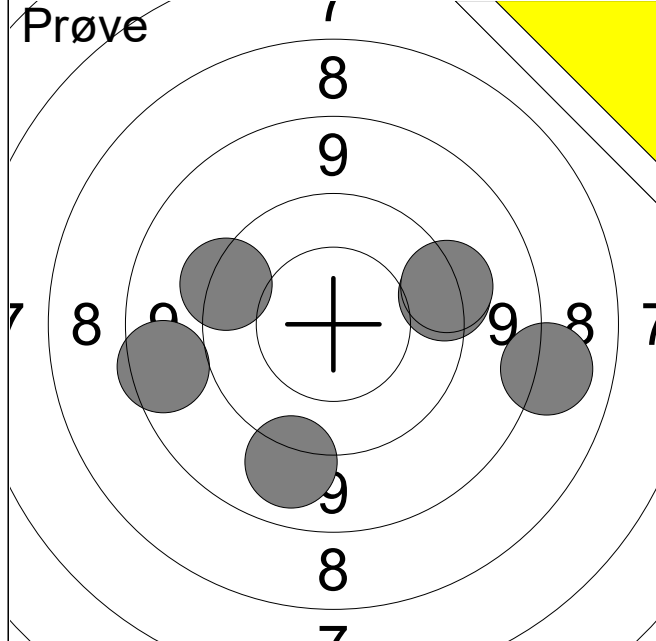

1:	8.8	←
2:	8.2	→
3:	9.6	→
4:	9.2	↓
5:	9.6	←
6:	9.5	→
Serie		52 (0x)
Total		0 (0x)

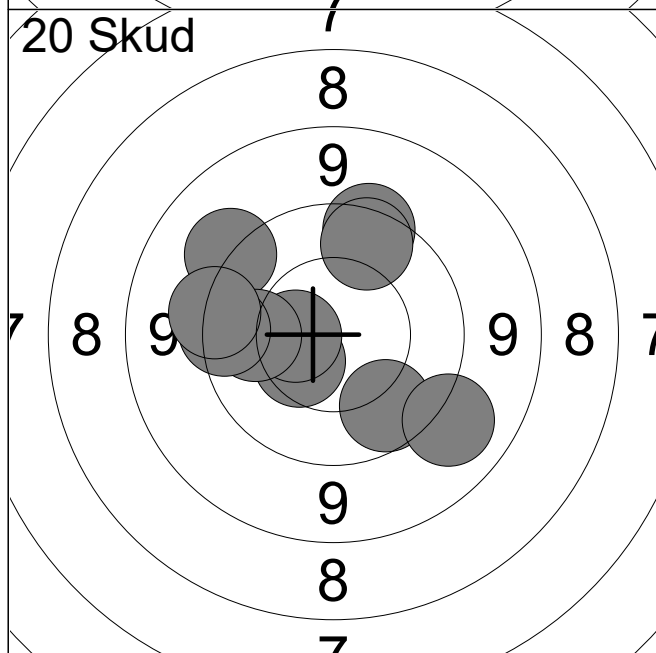

1:	9.4	↖
2:	10.4	↙
3:	10.5	←
4:	10.0	←
5:	9.6	↑
6:	9.8	↑
7:	9.9	↓
8:	9.2	↓
9:	9.6	←
10:	9.5	←
Serie		93 (0x)
Total		93 (0x)

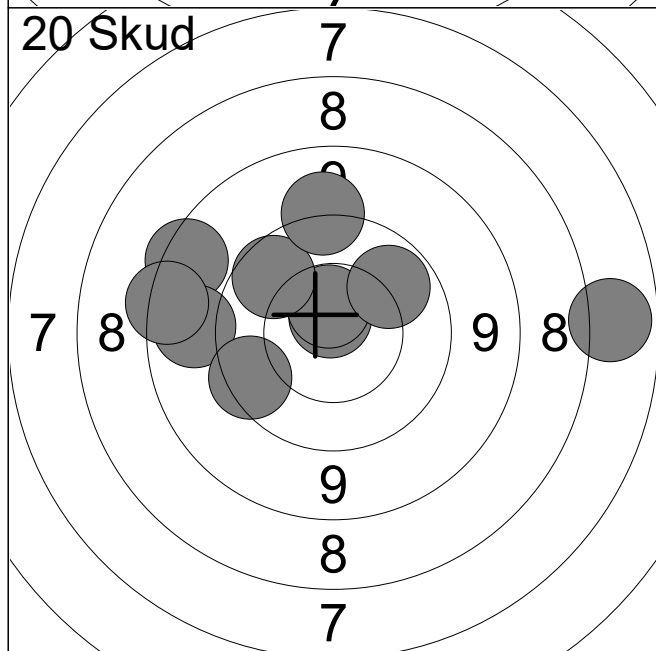

11:	8.7	↖
12:	10.7x	↑
13:	9.0	←
14:	10.6x	↑
15:	7.0	→
16:	9.7	↙
17:	9.9	↖
18:	8.6	←
19:	9.3	↑
20:	10.0	↗
Serie		89 (2x)
Total		182 (2x)

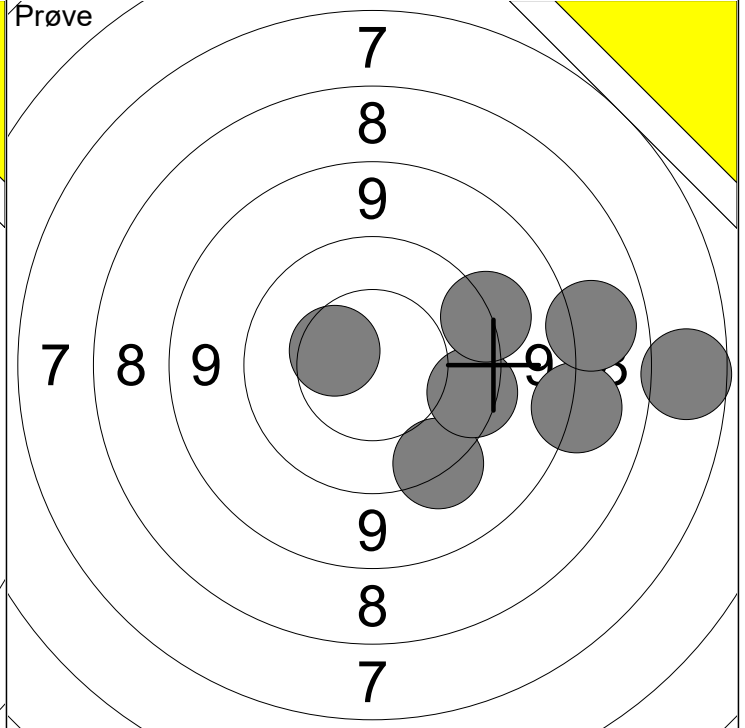
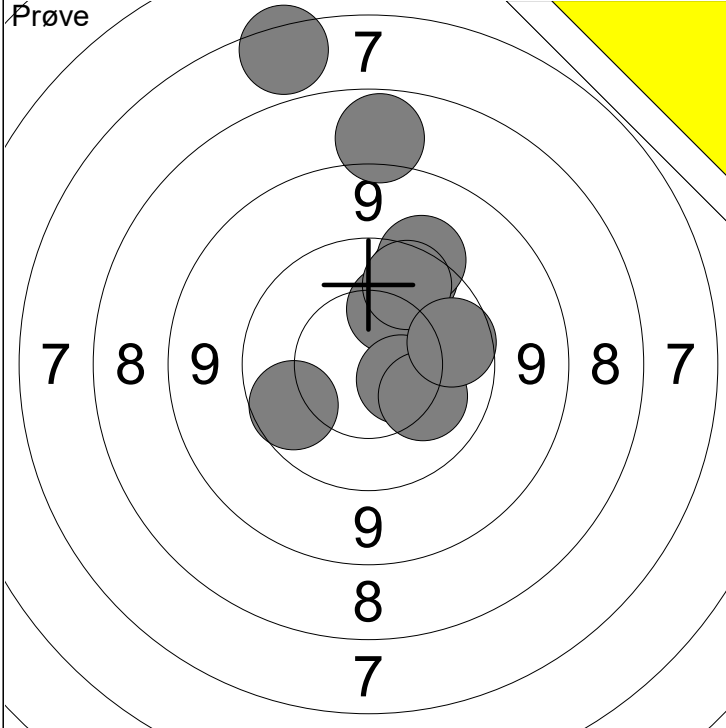

1: 8.0 ↑	6: 9.9 ←	Serie 89 (0x)
2: 6.7 ↑	7: 9.9 ↗	
3: 9.7 ↗	8: 10.5 →	Total 0 (0x)
4: 9.5 ↗	9: 10.2 →	
5: 10.2 ↑	10: 9.9 →	

11: 9.5 ↓	16: 9.4 →	Serie 59 (0x)
12: 9.7 →	17: 10.5 ←	
13: 8.3 →		Total 0 (0x)
14: 8.1 →		
15: 6.9 →		

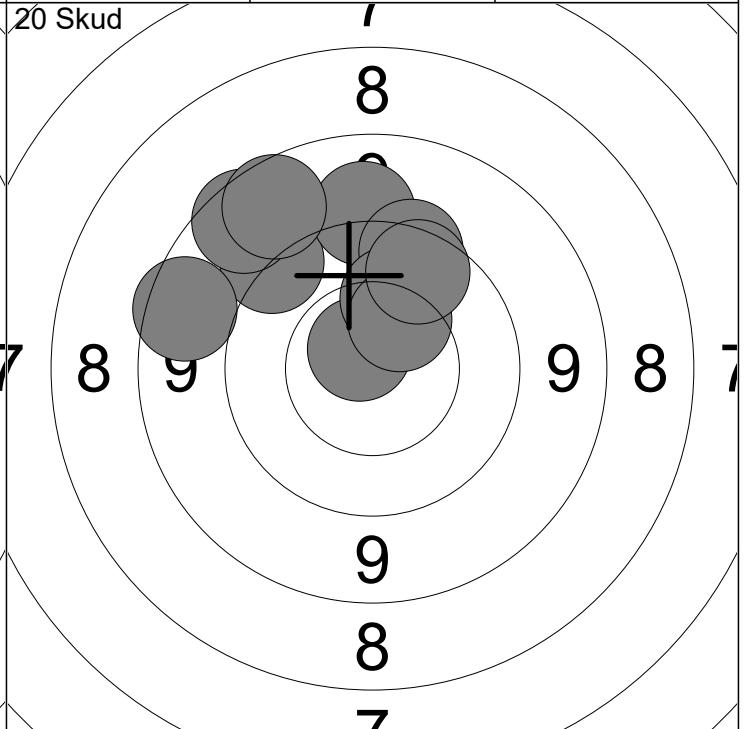
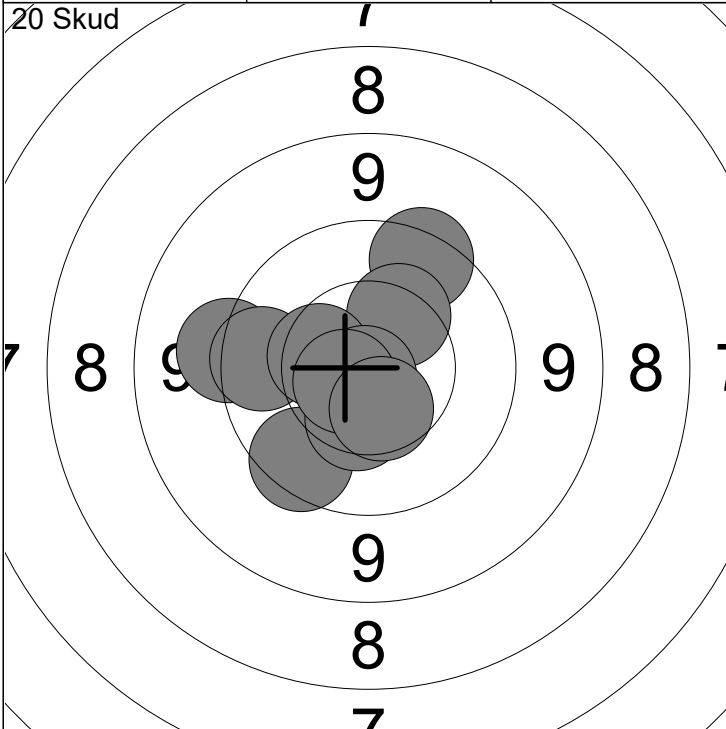

1: 9.7 ↓	6: 10.3 ↗	Serie 96 (2x)
2: 10.4 ↓	7: 10.4 ←	
3: 9.7 ↗	8: 10.8x ↓	Total 96 (2x)
4: 9.4 ←	9: 10.7x ←	
5: 9.8 ←	10: 10.5 ↓	

11: 9.4 ↗	16: 9.6 ↑	Serie 90 (1x)
12: 10.7x ↗	17: 10.2 ↑	
13: 9.3 ↑	18: 10.4 ↗	Total 186 (3x)
14: 8.8 ↗	19: 8.9 ↘	
15: 8.8 ←	20: 9.8 ↑	

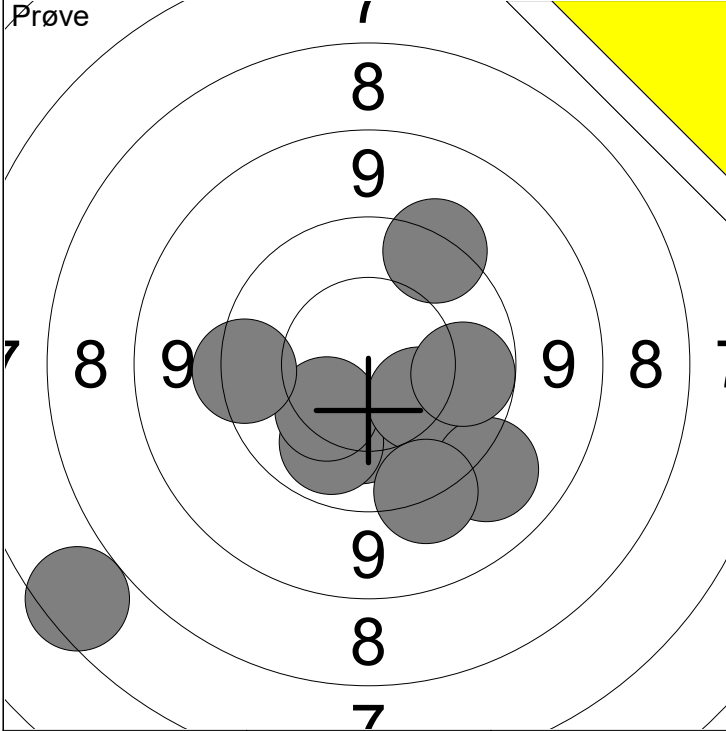

1: 10.2 ↓	6: 9.2 ↘	Serie 92 (0x)
2: 9.5 ↗	7: 6.7 ↙	
3: 10.0 ↓	8: 10.0 →	Total 0 (0x)
4: 10.3 ↙	9: 9.4 ↘	
5: 10.3 ↘	10: 9.6 ←	

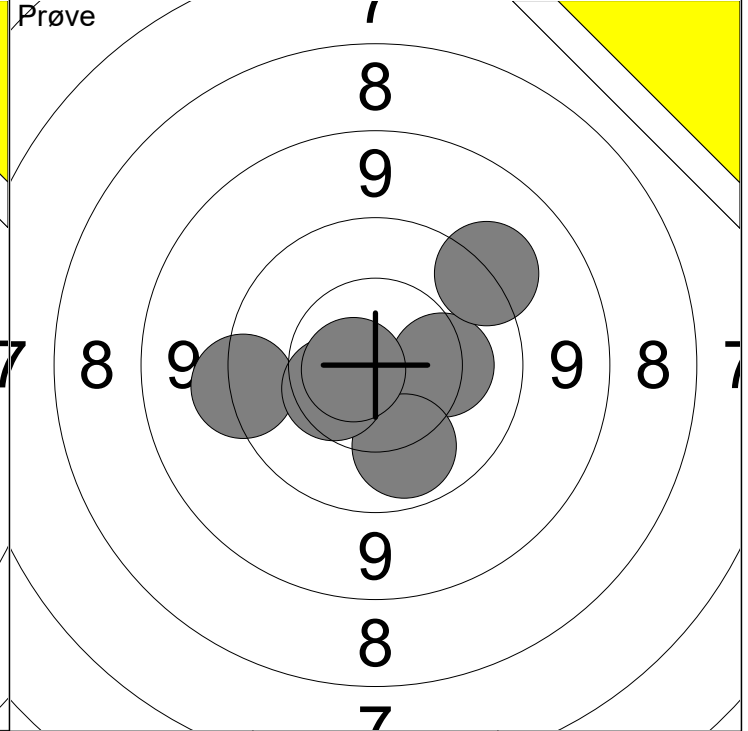

11: 9.5 ←	16: 10.7x ←	Serie 58 (1x)
12: 10.3 →	13: 10.0 ↓	
14: 9.4 ↗	15: 10.4 ←	Total 0 (0x)

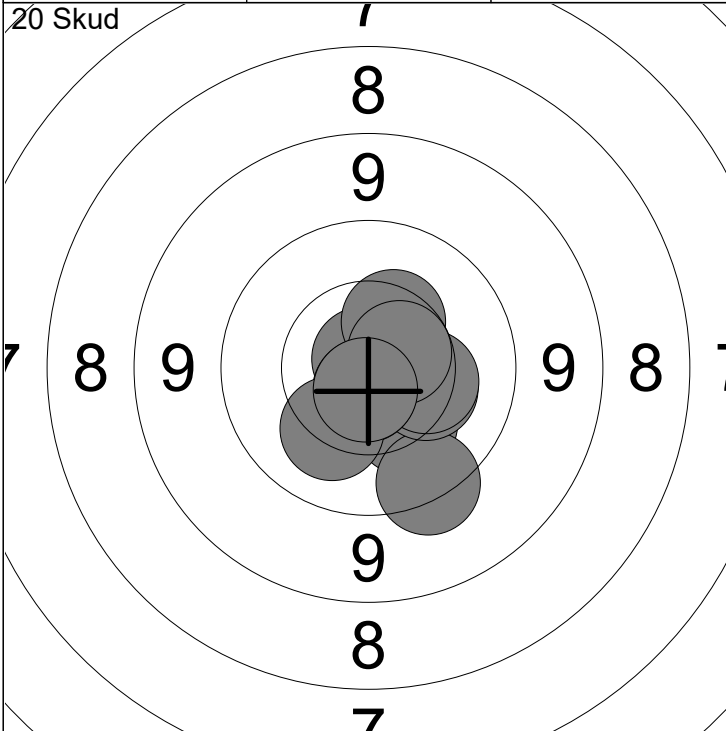

1: 10.3 ↘	6: 10.3 →	Serie 99 (4x)
2: 9.6 ↘	7: 10.7x ↓	
3: 10.3 →	8: 10.2 ↘	Total 99 (4x)
4: 10.8x ↗	9: 10.6x →	
5: 10.4 ↗	10: 10.7x ↓	

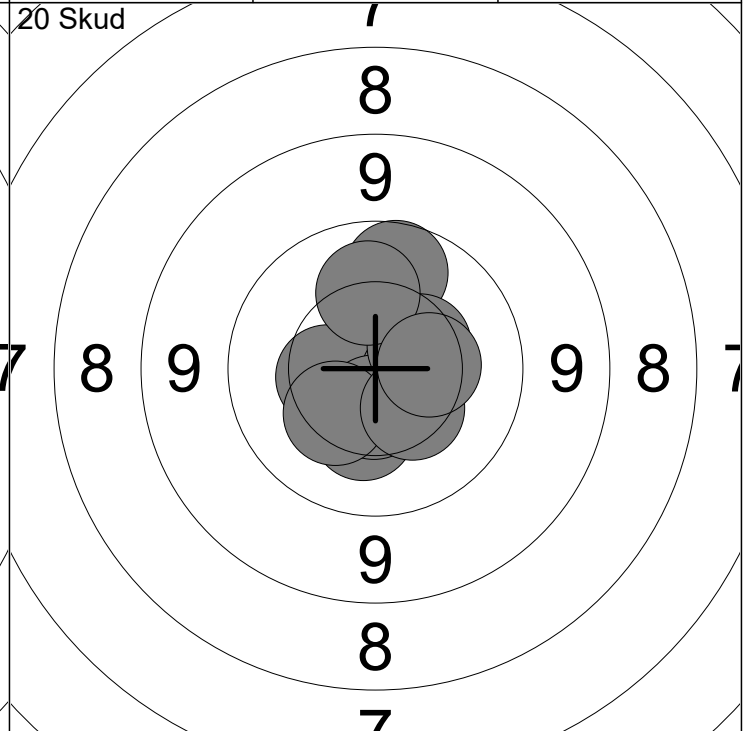

11: 9.9 ↗	16: 10.3 ↙	Serie 99 (0x)
12: 10.4 ←	17: 10.4 →	
13: 10.3 ↓	18: 10.2 ↗	Total 198 (4x)
14: 10.6 →	19: 10.4 ↘	
15: 10.5 ↓	20: 10.4 →	

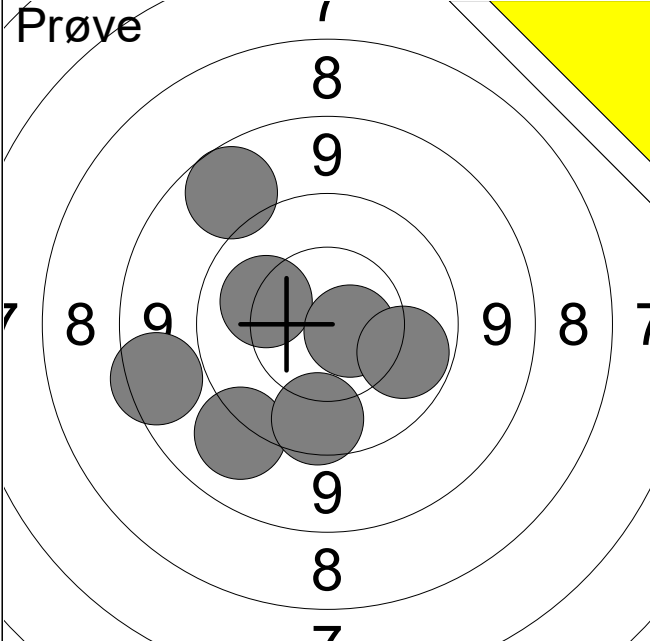
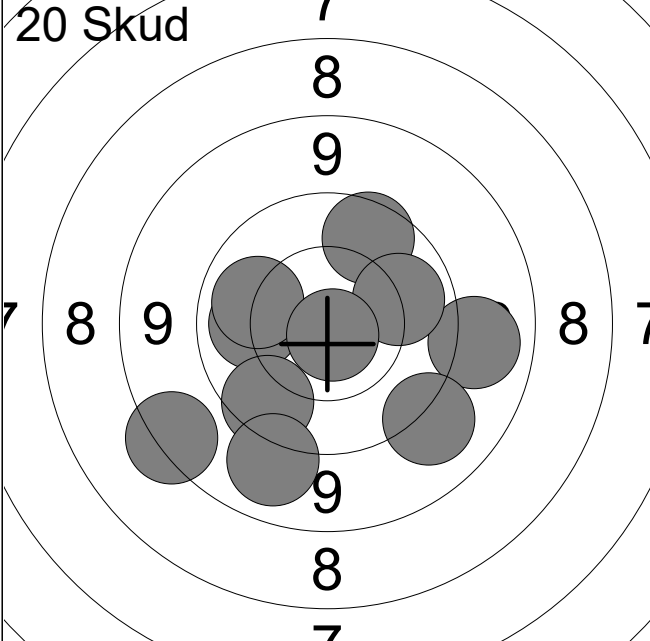
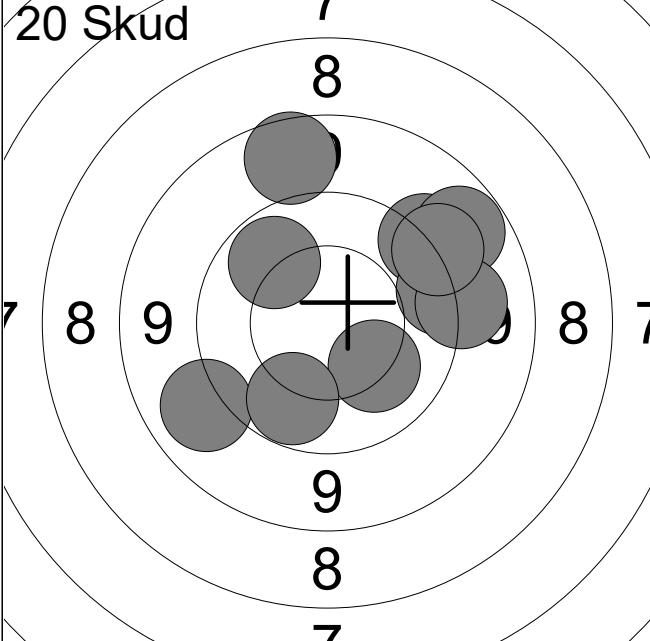
Hold 7	Skive 1	Thomas Pedersen																																
ØSF		Jørlunde Skytteforening		ST2																														
28.10.2024		Halloween Luftstævne 2024		Ølstykke skytteforening																														
Prøve		<table border="0"> <tr><td>1:</td><td>9.2</td><td>↙</td></tr> <tr><td>2:</td><td>9.8</td><td>↓</td></tr> <tr><td>3:</td><td>10.2</td><td>↖</td></tr> <tr><td>4:</td><td>8.9</td><td>↗</td></tr> <tr><td>5:</td><td>8.7</td><td>←</td></tr> <tr><td>6:</td><td>10.7x</td><td>→</td></tr> <tr><td>7:</td><td>10.0</td><td>→</td></tr> </table>			1:	9.2	↙	2:	9.8	↓	3:	10.2	↖	4:	8.9	↗	5:	8.7	←	6:	10.7x	→	7:	10.0	→									
1:	9.2	↙																																
2:	9.8	↓																																
3:	10.2	↖																																
4:	8.9	↗																																
5:	8.7	←																																
6:	10.7x	→																																
7:	10.0	→																																
		<table border="0"> <tr><td>Serie</td><td colspan="2">64 (1x)</td></tr> <tr><td>Total</td><td colspan="2">0 (0x)</td></tr> </table>			Serie	64 (1x)		Total	0 (0x)																									
Serie	64 (1x)																																	
Total	0 (0x)																																	
20 Skud		<table border="0"> <tr><td>1:</td><td>9.8</td><td>↑</td></tr> <tr><td>2:</td><td>9.1</td><td>→</td></tr> <tr><td>3:</td><td>8.5</td><td>↙</td></tr> <tr><td>4:</td><td>10.1</td><td>→</td></tr> <tr><td>5:</td><td>10.1</td><td>←</td></tr> <tr><td>6:</td><td>10.1</td><td>←</td></tr> <tr><td>7:</td><td>10.8x</td><td>↓</td></tr> <tr><td>8:</td><td>9.8</td><td>↙</td></tr> <tr><td>9:</td><td>9.2</td><td>↙</td></tr> <tr><td>10:</td><td>9.1</td><td>↓</td></tr> </table>			1:	9.8	↑	2:	9.1	→	3:	8.5	↙	4:	10.1	→	5:	10.1	←	6:	10.1	←	7:	10.8x	↓	8:	9.8	↙	9:	9.2	↙	10:	9.1	↓
1:	9.8	↑																																
2:	9.1	→																																
3:	8.5	↙																																
4:	10.1	→																																
5:	10.1	←																																
6:	10.1	←																																
7:	10.8x	↓																																
8:	9.8	↙																																
9:	9.2	↙																																
10:	9.1	↓																																
		<table border="0"> <tr><td>Serie</td><td colspan="2">93 (1x)</td></tr> <tr><td>Total</td><td colspan="2">93 (1x)</td></tr> </table>			Serie	93 (1x)		Total	93 (1x)																									
Serie	93 (1x)																																	
Total	93 (1x)																																	
20 Skud		<table border="0"> <tr><td>11:</td><td>9.1</td><td>↙</td></tr> <tr><td>12:</td><td>9.4</td><td>↗</td></tr> <tr><td>13:</td><td>9.5</td><td>→</td></tr> <tr><td>14:</td><td>8.9</td><td>↑</td></tr> <tr><td>15:</td><td>10.2</td><td>↙</td></tr> <tr><td>16:</td><td>9.0</td><td>↗</td></tr> <tr><td>17:</td><td>10.0</td><td>↓</td></tr> <tr><td>18:</td><td>9.3</td><td>→</td></tr> <tr><td>19:</td><td>10.0</td><td>↗</td></tr> <tr><td>20:</td><td>9.3</td><td>↗</td></tr> </table>			11:	9.1	↙	12:	9.4	↗	13:	9.5	→	14:	8.9	↑	15:	10.2	↙	16:	9.0	↗	17:	10.0	↓	18:	9.3	→	19:	10.0	↗	20:	9.3	↗
11:	9.1	↙																																
12:	9.4	↗																																
13:	9.5	→																																
14:	8.9	↑																																
15:	10.2	↙																																
16:	9.0	↗																																
17:	10.0	↓																																
18:	9.3	→																																
19:	10.0	↗																																
20:	9.3	↗																																
		<table border="0"> <tr><td>Serie</td><td colspan="2">92 (0x)</td></tr> <tr><td>Total</td><td colspan="2">185 (1x)</td></tr> </table>			Serie	92 (0x)		Total	185 (1x)																									
Serie	92 (0x)																																	
Total	185 (1x)																																	

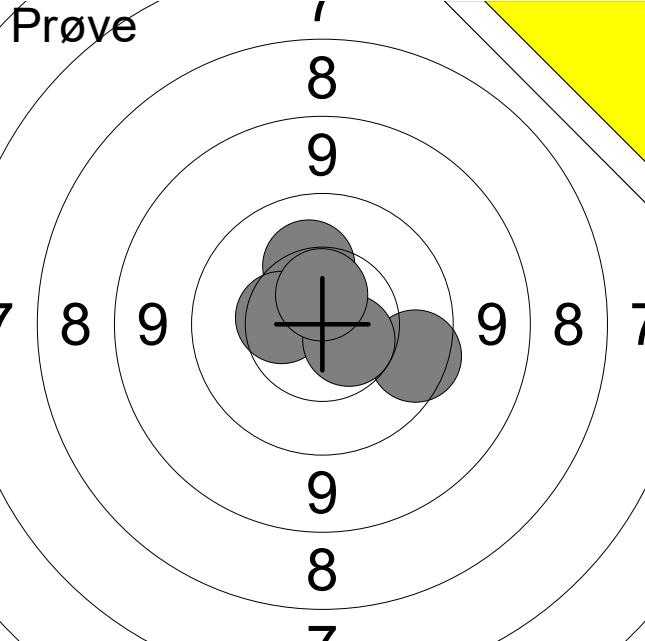
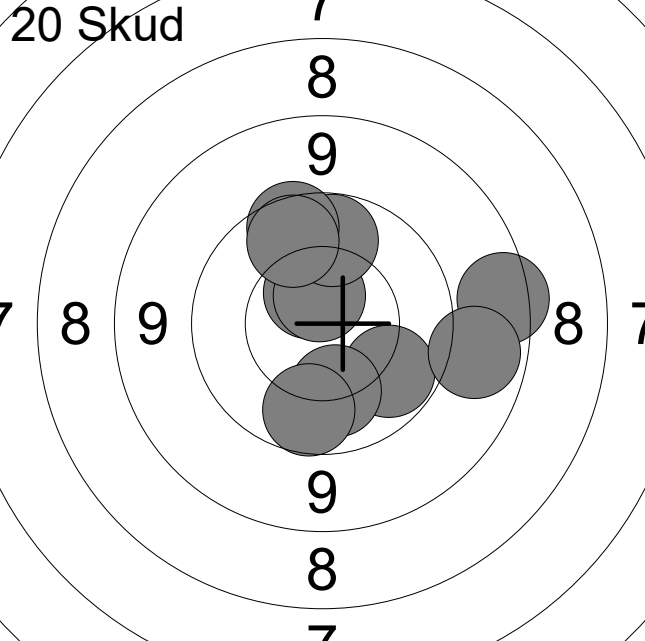
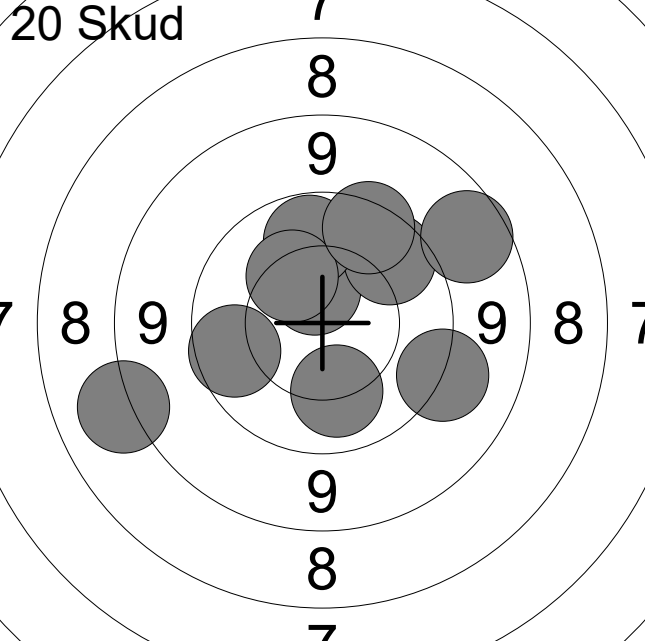
Hold	Skive	Ida Lund Nellemann		
7	2	ØSF	Ølstykke Skytteforening	MÅ2
28.10.2024	Halloween Luftstævne 2024	Ølstykke skytteforening		
Prøve		1:	10.2	↑
		2:	9.8	→
		3:	10.5	←
		4:	10.6x	↘
		5:	10.6x	↑
Serie		49 (2x)		
Total		0 (0x)		
20 Skud		1:	10.6	↑
		2:	10.0	↘
		3:	10.6x	↑
		4:	10.1	↓
		5:	9.9	↓
		6:	8.7	→
		7:	10.0	↑
		8:	9.7	↑
		9:	9.9	↑
		10:	9.0	→
Serie		94 (1x)		
Total		94 (1x)		
20 Skud		11:	9.9	←
		12:	10.5	↑
		13:	9.8	↗
		14:	10.1	↓
		15:	9.3	↘
		16:	8.2	←
		17:	10.0	↑
		18:	10.3	↗
		19:	8.9	↗
		20:	9.7	↑
Serie		92 (0x)		
Total		186 (1x)		

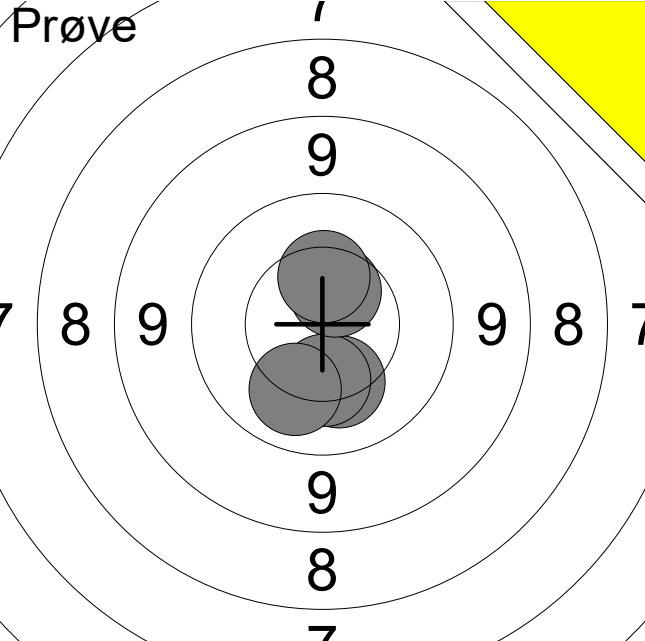
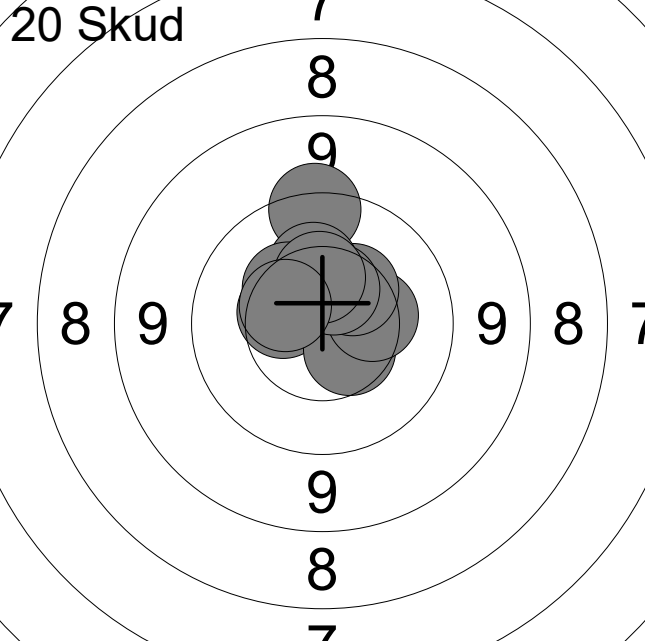
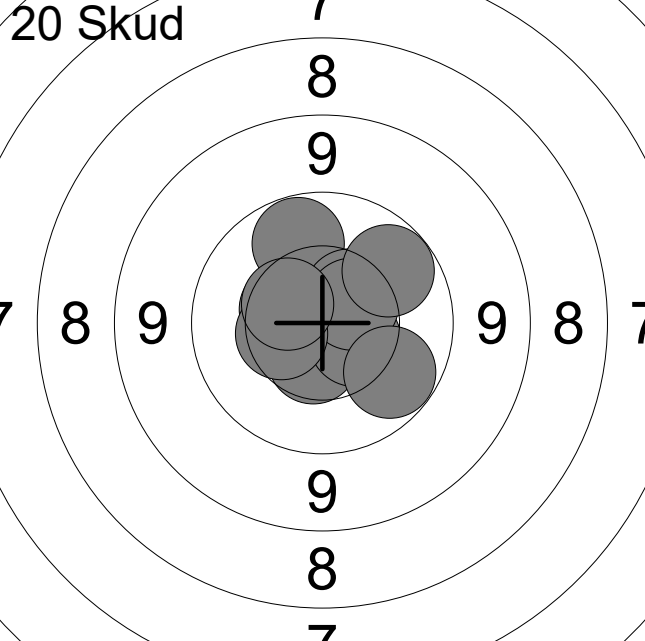
Hold 7	Skive 4	Peter Hansen		
ØSF		Ballerup Skytteforening		MSE1
28.10.2024		Halloween Luftstævne 2024		Ølstykke skytteforening
Prøve		1: 10.2 ↓ 2: 10.3 ↓ 3: 10.1 ↓ 4: 10.5 ↑ 5: 10.4 ↑		
		Serie 50 (0x)		
		Total 0 (0x)		
20 Skud		1: 10.5 ← 2: 10.5 ↓ 3: 9.6 ↑ 4: 10.3 → 5: 10.4 ↗ 6: 10.3 ↑ 7: 10.5 ↑ 8: 10.4 ↗ 9: 10.4 ↑ 10: 10.5 ←		
		Serie 99 (0x)		
		Total 99 (0x)		
20 Skud		11: 10.5 ← 12: 10.0 ↑ 13: 10.5 ↓ 14: 10.5 → 15: 10.5 ↗ 16: 10.5 ↗ 17: 10.4 ← 18: 10.5 ← 19: 10.0 ↓ 20: 10.0 ↗		
		Serie 100 (0x)		
		Total 199 (0x)		

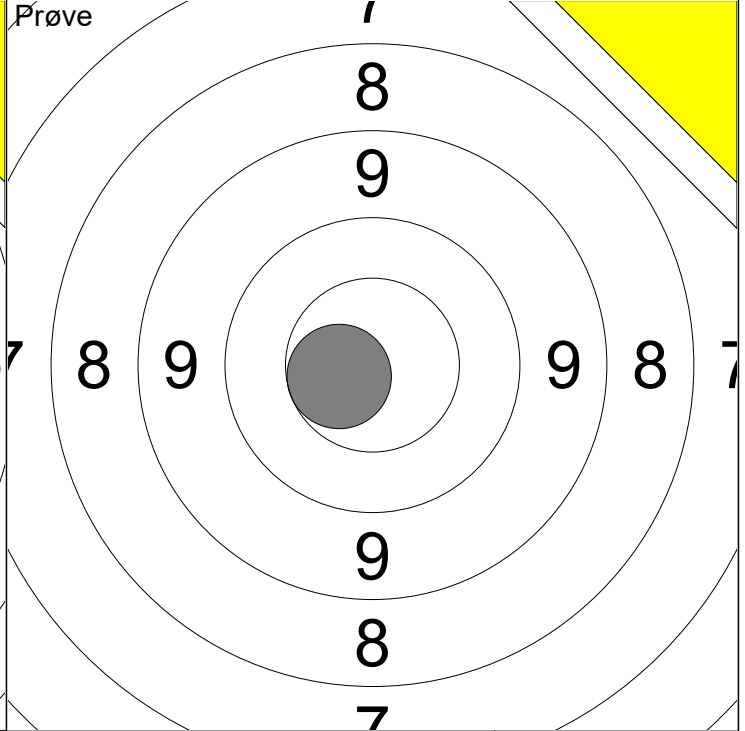
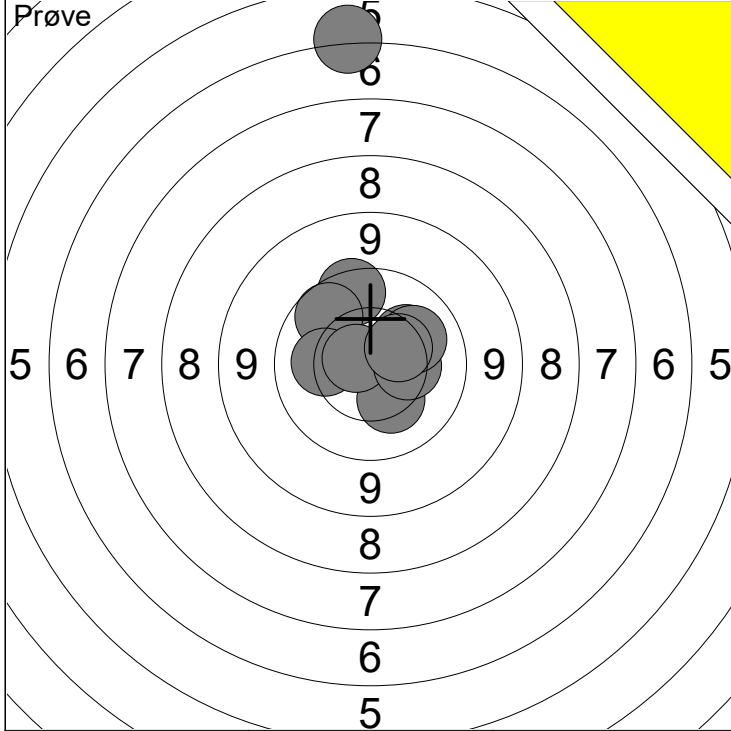

1: 5.3 ↑	6: 10.2 ↗	Serie 93 (1x)
2: 9.7 ↑	7: 10.7x ↖	
3: 9.9 ↗	8: 10.3 →	Total 0 (0x)
4: 10.2 ←	9: 10.2 ↗	
5: 10.3 ↓	10: 10.4 ↗	

11: 10.6 ←	Serie 10 (0x)
	Total 0 (0x)

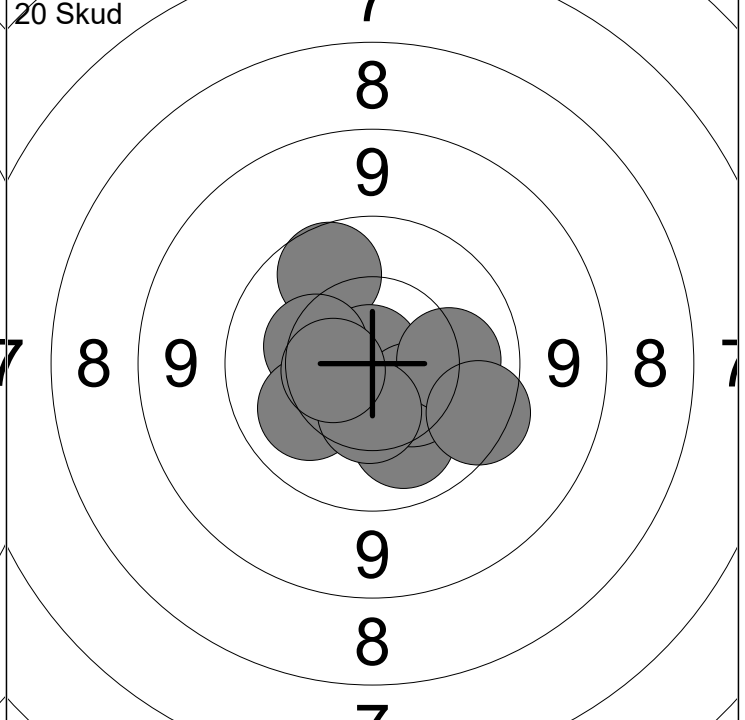
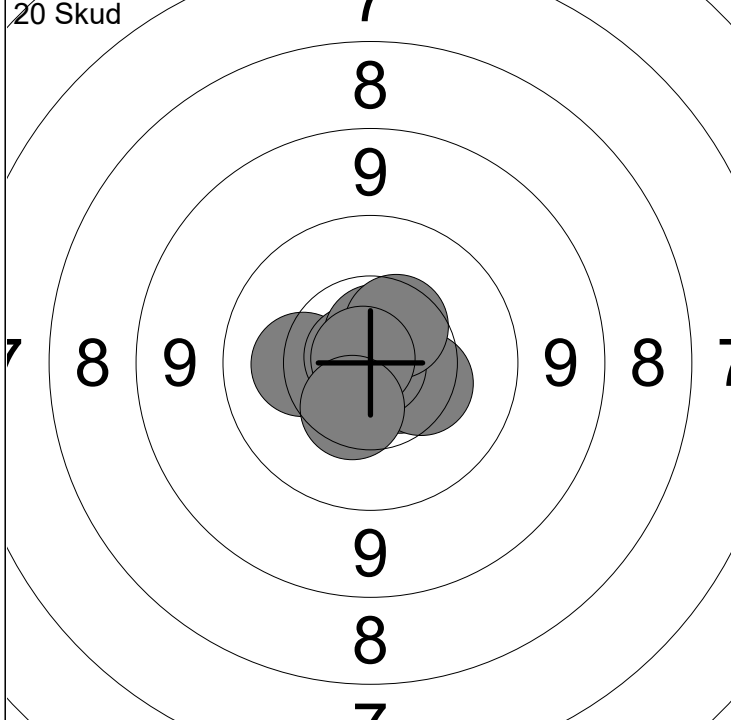

1: 10.2 ←	6: 10.9x ↘	Serie 100 (6x)
2: 10.6x ↘	7: 10.7x ↑	
3: 10.8x ↖	8: 10.5 ↗	Total 100 (6x)
4: 10.8x ↗	9: 10.9x ↖	
5: 10.4 ↘	10: 10.4 ↓	

11: 9.9 ↗	16: 10.3 ←	Serie 98 (1x)
12: 10.9x ↑	17: 10.1 ↖	
13: 10.1 ↓	18: 9.7 ↘	Total 198 (7x)
14: 10.4 ↘	19: 10.4 ↓	
15: 10.2 →	20: 10.5 ←	

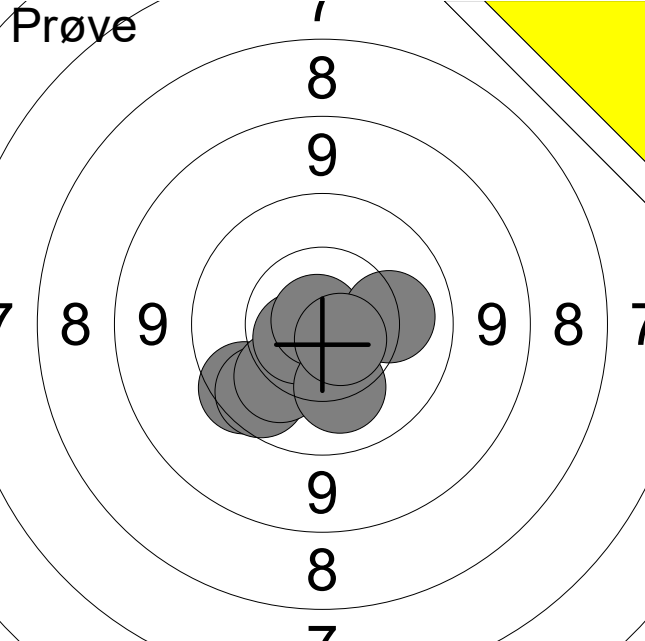
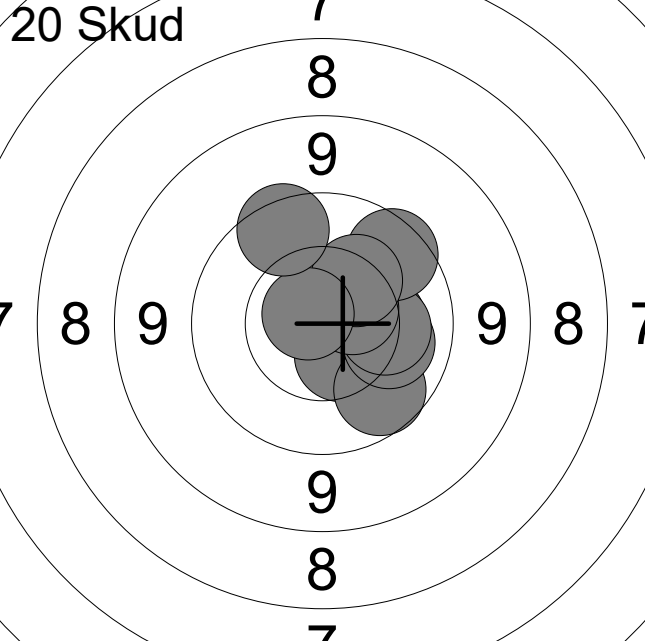
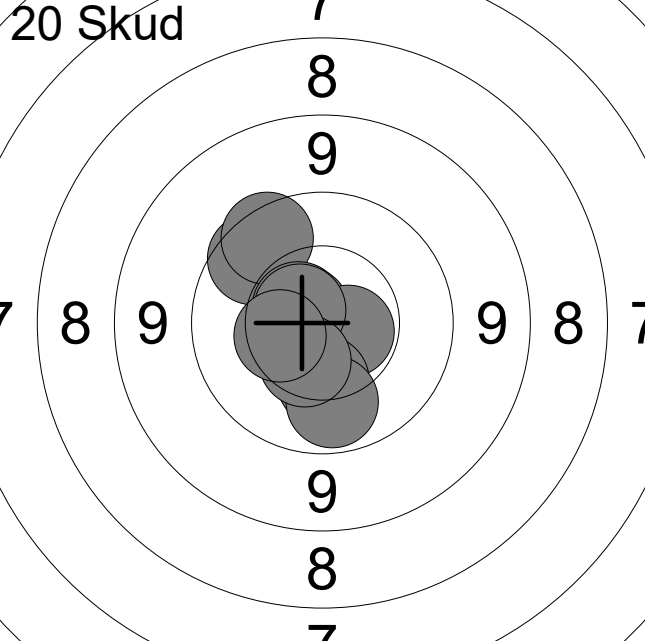
Hold 7	Skive 7	Catharina Bjerreskov																																
ØSF		Ølstykke Skytteforening		MJ1																														
28.10.2024		Halloween Luftstævne 2024		Ølstykke skytteforening																														
Prøve		<table border="0"> <tr><td>1:</td><td>9.7</td><td>↙</td></tr> <tr><td>2:</td><td>9.9</td><td>↙</td></tr> <tr><td>3:</td><td>10.2</td><td>↙</td></tr> <tr><td>4:</td><td>10.7x</td><td>↘</td></tr> <tr><td>5:</td><td>10.6x</td><td>↙</td></tr> <tr><td>6:</td><td>10.9x</td><td>↗</td></tr> <tr><td>7:</td><td>10.2</td><td>→</td></tr> <tr><td>8:</td><td>10.2</td><td>↘</td></tr> <tr><td>9:</td><td>10.7x</td><td>↘</td></tr> </table>			1:	9.7	↙	2:	9.9	↙	3:	10.2	↙	4:	10.7x	↘	5:	10.6x	↙	6:	10.9x	↗	7:	10.2	→	8:	10.2	↘	9:	10.7x	↘			
1:	9.7	↙																																
2:	9.9	↙																																
3:	10.2	↙																																
4:	10.7x	↘																																
5:	10.6x	↙																																
6:	10.9x	↗																																
7:	10.2	→																																
8:	10.2	↘																																
9:	10.7x	↘																																
		<table border="0"> <tr><td>Serie</td><td colspan="2">88 (4x)</td></tr> <tr><td>Total</td><td colspan="2">0 (0x)</td></tr> </table>			Serie	88 (4x)		Total	0 (0x)																									
Serie	88 (4x)																																	
Total	0 (0x)																																	
20 Skud		<table border="0"> <tr><td>1:</td><td>10.5</td><td>↘</td></tr> <tr><td>2:</td><td>10.3</td><td>→</td></tr> <tr><td>3:</td><td>9.9</td><td>↘</td></tr> <tr><td>4:</td><td>10.1</td><td>↘</td></tr> <tr><td>5:</td><td>10.2</td><td>→</td></tr> <tr><td>6:</td><td>10.5</td><td>↗</td></tr> <tr><td>7:</td><td>9.8</td><td>↗</td></tr> <tr><td>8:</td><td>10.3</td><td>↗</td></tr> <tr><td>9:</td><td>10.7x</td><td>↗</td></tr> <tr><td>10:</td><td>9.7</td><td>↗</td></tr> </table>			1:	10.5	↘	2:	10.3	→	3:	9.9	↘	4:	10.1	↘	5:	10.2	→	6:	10.5	↗	7:	9.8	↗	8:	10.3	↗	9:	10.7x	↗	10:	9.7	↗
1:	10.5	↘																																
2:	10.3	→																																
3:	9.9	↘																																
4:	10.1	↘																																
5:	10.2	→																																
6:	10.5	↗																																
7:	9.8	↗																																
8:	10.3	↗																																
9:	10.7x	↗																																
10:	9.7	↗																																
		<table border="0"> <tr><td>Serie</td><td colspan="2">97 (1x)</td></tr> <tr><td>Total</td><td colspan="2">97 (1x)</td></tr> </table>			Serie	97 (1x)		Total	97 (1x)																									
Serie	97 (1x)																																	
Total	97 (1x)																																	
20 Skud		<table border="0"> <tr><td>11:</td><td>9.8</td><td>↗</td></tr> <tr><td>12:</td><td>9.7</td><td>↗</td></tr> <tr><td>13:</td><td>10.6x</td><td>↗</td></tr> <tr><td>14:</td><td>10.7x</td><td>↗</td></tr> <tr><td>15:</td><td>10.6x</td><td>↘</td></tr> <tr><td>16:</td><td>10.6x</td><td>↗</td></tr> <tr><td>17:</td><td>10.3</td><td>↘</td></tr> <tr><td>18:</td><td>10.0</td><td>↘</td></tr> <tr><td>19:</td><td>10.5</td><td>↘</td></tr> <tr><td>20:</td><td>10.4</td><td>↙</td></tr> </table>			11:	9.8	↗	12:	9.7	↗	13:	10.6x	↗	14:	10.7x	↗	15:	10.6x	↘	16:	10.6x	↗	17:	10.3	↘	18:	10.0	↘	19:	10.5	↘	20:	10.4	↙
11:	9.8	↗																																
12:	9.7	↗																																
13:	10.6x	↗																																
14:	10.7x	↗																																
15:	10.6x	↘																																
16:	10.6x	↗																																
17:	10.3	↘																																
18:	10.0	↘																																
19:	10.5	↘																																
20:	10.4	↙																																
		<table border="0"> <tr><td>Serie</td><td colspan="2">98 (4x)</td></tr> <tr><td>Total</td><td colspan="2">195 (5x)</td></tr> </table>			Serie	98 (4x)		Total	195 (5x)																									
Serie	98 (4x)																																	
Total	195 (5x)																																	

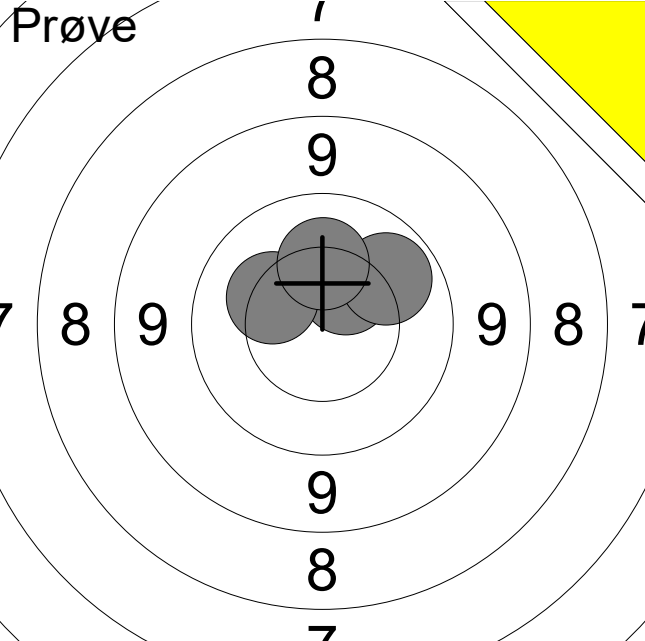
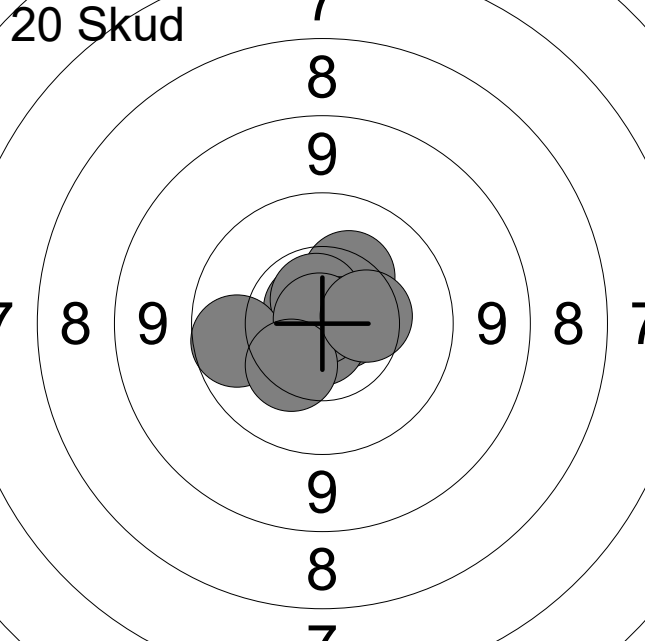
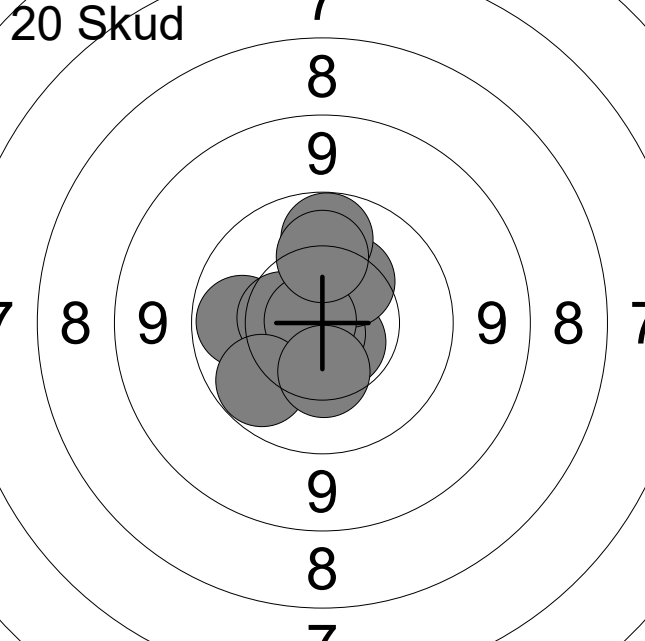
Hold	Skive	Steffen Koefoed		
7	9	ØSF	Fløng-Hedehusene Skytteforening	MST1
28.10.2024	Halloween Luftstævne 2024	Ølstykke skytteforening		
Prøve 	1:	10.4	↗	
	2:	10.3	↖	
	3:	10.0	↗	
	4:	10.2	↑	
	Serie			40 (0x)
Total			0 (0x)	
20 Skud 	1:	10.3	↗	
	2:	10.9x	↖	
	3:	10.7x	↗	
	4:	10.7x	↑	
	5:	9.9	↖	
	6:	10.7x	→	
	7:	10.8x	↓	
	8:	10.9x	↗	
	9:	10.3	↘	
	10:	10.4	→	
	Serie			99 (6x)
Total			99 (6x)	
20 Skud 	11:	10.6x	↘	
	12:	10.8x	↓	
	13:	10.4	↗	
	14:	10.0	↖	
	15:	10.5	↖	
	16:	10.0	↑	
	17:	10.8x	↖	
	18:	10.0	↘	
	19:	10.4	↓	
	20:	10.2	↑	
	Serie			100 (3x)
Total			199 (9x)	

Hold 7	Skive 11	Bjoern Thomsen																																
ØSF		Ganløse Skytteforening		Å2																														
28.10.2024		Halloween Luftstævne 2024		Ølstykke skytteforening																														
Prøve		<table border="0"> <tr><td>1:</td><td>10.2</td><td>↘</td></tr> <tr><td>2:</td><td>9.7</td><td>→</td></tr> <tr><td>3:</td><td>10.3</td><td>→</td></tr> <tr><td>4:</td><td>10.5</td><td>→</td></tr> <tr><td>5:</td><td>10.5</td><td>→</td></tr> <tr><td>6:</td><td>10.5</td><td>↗</td></tr> <tr><td>7:</td><td>10.4</td><td>→</td></tr> <tr><td>8:</td><td>10.7x</td><td>→</td></tr> </table>			1:	10.2	↘	2:	9.7	→	3:	10.3	→	4:	10.5	→	5:	10.5	→	6:	10.5	↗	7:	10.4	→	8:	10.7x	→						
1:	10.2	↘																																
2:	9.7	→																																
3:	10.3	→																																
4:	10.5	→																																
5:	10.5	→																																
6:	10.5	↗																																
7:	10.4	→																																
8:	10.7x	→																																
		<table border="0"> <tr><td>Serie</td><td colspan="2">79 (1x)</td></tr> <tr><td>Total</td><td colspan="2">0 (0x)</td></tr> </table>			Serie	79 (1x)		Total	0 (0x)																									
Serie	79 (1x)																																	
Total	0 (0x)																																	
20 Skud		<table border="0"> <tr><td>1:</td><td>10.6</td><td>→</td></tr> <tr><td>2:</td><td>10.2</td><td>↘</td></tr> <tr><td>3:</td><td>10.3</td><td>↘</td></tr> <tr><td>4:</td><td>10.7x</td><td>↗</td></tr> <tr><td>5:</td><td>9.9</td><td>↖</td></tr> <tr><td>6:</td><td>10.5</td><td>↘</td></tr> <tr><td>7:</td><td>10.4</td><td>←</td></tr> <tr><td>8:</td><td>10.3</td><td>←</td></tr> <tr><td>9:</td><td>10.4</td><td>→</td></tr> <tr><td>10:</td><td>10.6x</td><td>↘</td></tr> </table>			1:	10.6	→	2:	10.2	↘	3:	10.3	↘	4:	10.7x	↗	5:	9.9	↖	6:	10.5	↘	7:	10.4	←	8:	10.3	←	9:	10.4	→	10:	10.6x	↘
1:	10.6	→																																
2:	10.2	↘																																
3:	10.3	↘																																
4:	10.7x	↗																																
5:	9.9	↖																																
6:	10.5	↘																																
7:	10.4	←																																
8:	10.3	←																																
9:	10.4	→																																
10:	10.6x	↘																																
		<table border="0"> <tr><td>Serie</td><td colspan="2">99 (2x)</td></tr> <tr><td>Total</td><td colspan="2">99 (2x)</td></tr> </table>			Serie	99 (2x)		Total	99 (2x)																									
Serie	99 (2x)																																	
Total	99 (2x)																																	
20 Skud		<table border="0"> <tr><td>11:</td><td>10.4</td><td>→</td></tr> <tr><td>12:</td><td>10.7x</td><td>↗</td></tr> <tr><td>13:</td><td>10.4</td><td>→</td></tr> <tr><td>14:</td><td>10.2</td><td>←</td></tr> <tr><td>15:</td><td>10.3</td><td>←</td></tr> <tr><td>16:</td><td>10.3</td><td>←</td></tr> <tr><td>17:</td><td>10.2</td><td>←</td></tr> <tr><td>18:</td><td>10.8x</td><td>→</td></tr> <tr><td>19:</td><td>10.2</td><td>←</td></tr> <tr><td>20:</td><td>10.4</td><td>↖</td></tr> </table>			11:	10.4	→	12:	10.7x	↗	13:	10.4	→	14:	10.2	←	15:	10.3	←	16:	10.3	←	17:	10.2	←	18:	10.8x	→	19:	10.2	←	20:	10.4	↖
11:	10.4	→																																
12:	10.7x	↗																																
13:	10.4	→																																
14:	10.2	←																																
15:	10.3	←																																
16:	10.3	←																																
17:	10.2	←																																
18:	10.8x	→																																
19:	10.2	←																																
20:	10.4	↖																																
		<table border="0"> <tr><td>Serie</td><td colspan="2">100 (2x)</td></tr> <tr><td>Total</td><td colspan="2">199 (4x)</td></tr> </table>			Serie	100 (2x)		Total	199 (4x)																									
Serie	100 (2x)																																	
Total	199 (4x)																																	

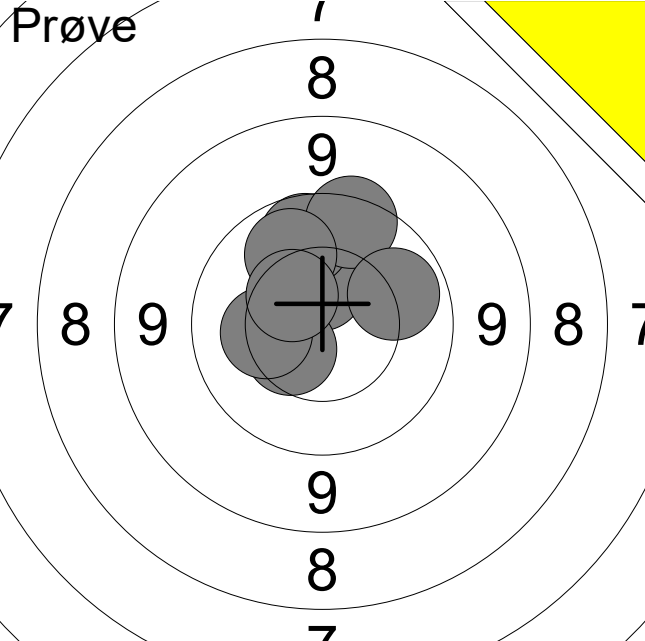
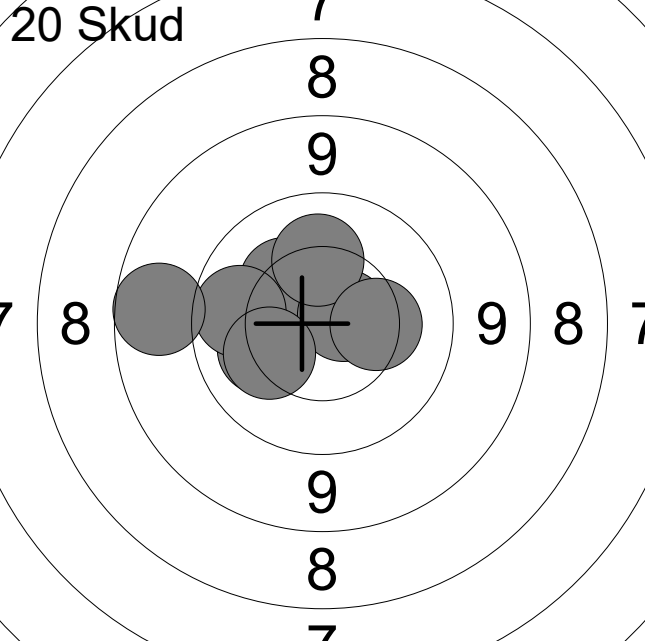
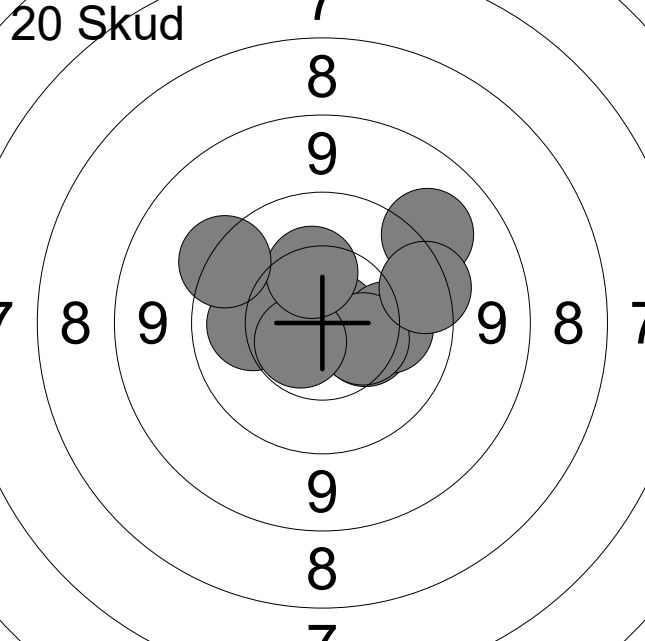
Hold 8	Skive 2	Mikkel Kannik																																
ØSF		Ølstykke Skytteforening		MST2																														
28.10.2024		Halloween Luftstævne 2024		Ølstykke skytteforening																														
Prøve		<table border="0"> <tr><td>1:</td><td>10.5</td><td>↑</td></tr> <tr><td>2:</td><td>9.9</td><td>↑</td></tr> <tr><td>3:</td><td>10.5</td><td>↙</td></tr> <tr><td>4:</td><td>9.7</td><td>↑</td></tr> <tr><td>5:</td><td>10.0</td><td>↑</td></tr> <tr><td>6:</td><td>10.0</td><td>→</td></tr> <tr><td>7:</td><td>10.3</td><td>←</td></tr> <tr><td>8:</td><td>10.5</td><td>↖</td></tr> </table>			1:	10.5	↑	2:	9.9	↑	3:	10.5	↙	4:	9.7	↑	5:	10.0	↑	6:	10.0	→	7:	10.3	←	8:	10.5	↖						
1:	10.5	↑																																
2:	9.9	↑																																
3:	10.5	↙																																
4:	9.7	↑																																
5:	10.0	↑																																
6:	10.0	→																																
7:	10.3	←																																
8:	10.5	↖																																
		<table border="0"> <tr><td>Serie</td><td colspan="3">78 (0x)</td></tr> <tr><td>Total</td><td colspan="3">0 (0x)</td></tr> </table>			Serie	78 (0x)			Total	0 (0x)																								
Serie	78 (0x)																																	
Total	0 (0x)																																	
20 Skud		<table border="0"> <tr><td>1:</td><td>10.2</td><td>←</td></tr> <tr><td>2:</td><td>10.5</td><td>↙</td></tr> <tr><td>3:</td><td>10.6x</td><td>↗</td></tr> <tr><td>4:</td><td>10.3</td><td>↗</td></tr> <tr><td>5:</td><td>10.7x</td><td>→</td></tr> <tr><td>6:</td><td>10.0</td><td>←</td></tr> <tr><td>7:</td><td>10.2</td><td>↑</td></tr> <tr><td>8:</td><td>10.2</td><td>↙</td></tr> <tr><td>9:</td><td>10.3</td><td>→</td></tr> <tr><td>10:</td><td>8.9</td><td>←</td></tr> </table>			1:	10.2	←	2:	10.5	↙	3:	10.6x	↗	4:	10.3	↗	5:	10.7x	→	6:	10.0	←	7:	10.2	↑	8:	10.2	↙	9:	10.3	→	10:	8.9	←
1:	10.2	←																																
2:	10.5	↙																																
3:	10.6x	↗																																
4:	10.3	↗																																
5:	10.7x	→																																
6:	10.0	←																																
7:	10.2	↑																																
8:	10.2	↙																																
9:	10.3	→																																
10:	8.9	←																																
		<table border="0"> <tr><td>Serie</td><td colspan="3">98 (2x)</td></tr> <tr><td>Total</td><td colspan="3">98 (2x)</td></tr> </table>			Serie	98 (2x)			Total	98 (2x)																								
Serie	98 (2x)																																	
Total	98 (2x)																																	
20 Skud		<table border="0"> <tr><td>11:</td><td>10.8x</td><td>→</td></tr> <tr><td>12:</td><td>9.3</td><td>↗</td></tr> <tr><td>13:</td><td>10.4</td><td>→</td></tr> <tr><td>14:</td><td>10.2</td><td>→</td></tr> <tr><td>15:</td><td>10.1</td><td>←</td></tr> <tr><td>16:</td><td>10.4</td><td>→</td></tr> <tr><td>17:</td><td>10.6x</td><td>↙</td></tr> <tr><td>18:</td><td>10.3</td><td>↑</td></tr> <tr><td>19:</td><td>9.6</td><td>→</td></tr> <tr><td>20:</td><td>9.6</td><td>↖</td></tr> </table>			11:	10.8x	→	12:	9.3	↗	13:	10.4	→	14:	10.2	→	15:	10.1	←	16:	10.4	→	17:	10.6x	↙	18:	10.3	↑	19:	9.6	→	20:	9.6	↖
11:	10.8x	→																																
12:	9.3	↗																																
13:	10.4	→																																
14:	10.2	→																																
15:	10.1	←																																
16:	10.4	→																																
17:	10.6x	↙																																
18:	10.3	↑																																
19:	9.6	→																																
20:	9.6	↖																																
		<table border="0"> <tr><td>Serie</td><td colspan="3">97 (2x)</td></tr> <tr><td>Total</td><td colspan="3">195 (4x)</td></tr> </table>			Serie	97 (2x)			Total	195 (4x)																								
Serie	97 (2x)																																	
Total	195 (4x)																																	

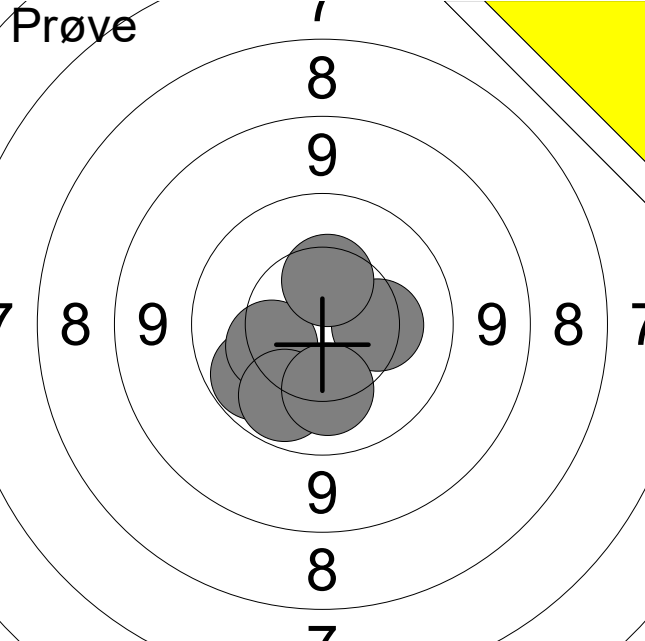
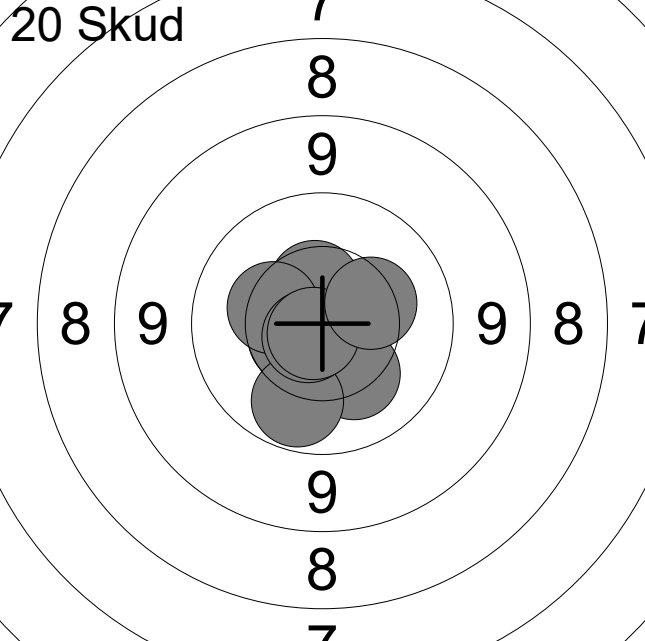
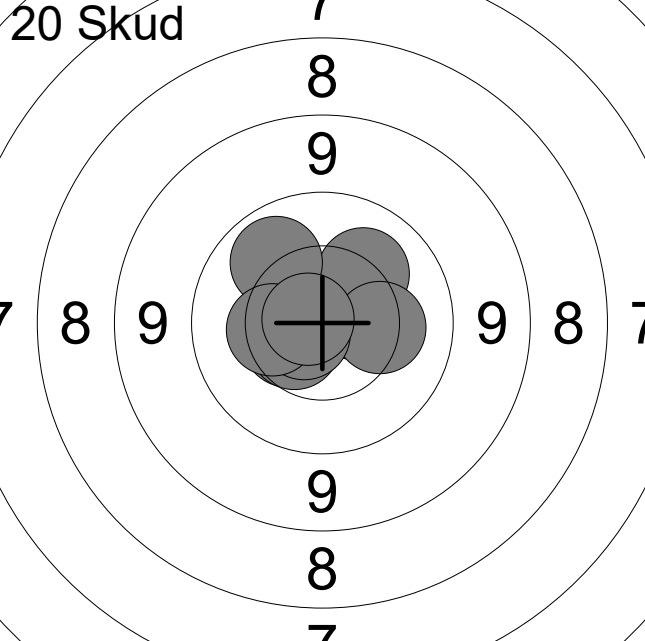
Hold 8	Skive 6	Laura Daugaard Thomsen		
ØSF		Ølstykke Skytteforening		MFR12
28.10.2024		Halloween Luftstævne 2024		Ølstykke skytteforening
Prøve		1: 10.3 → 2: 10.0 ↙ 3: 10.3 ← 4: 10.0 ↘ 5: 10.2 ↓ 6: 10.4 ↑		
		Serie 60 (0x)		
		Total 0 (0x)		
20 Skud		1: 10.8x ↑ 2: 10.6 ↙ 3: 10.6 ↗ 4: 10.2 ↘ 5: 10.5 ↑ 6: 10.0 ↓ 7: 10.3 ← 8: 10.7x ↙ 9: 10.8x ↘ 10: 10.3 →		
		Serie 100 (3x)		
		Total 100 (3x)		
20 Skud		11: 10.5 → 12: 10.7x ↖ 13: 10.2 ↗ 14: 10.5 ↙ 15: 10.5 ↙ 16: 10.3 → 17: 10.7x ↙ 18: 10.0 ↗ 19: 10.4 ← 20: 10.8x ↙		
		Serie 100 (3x)		
		Total 200 (6x)		

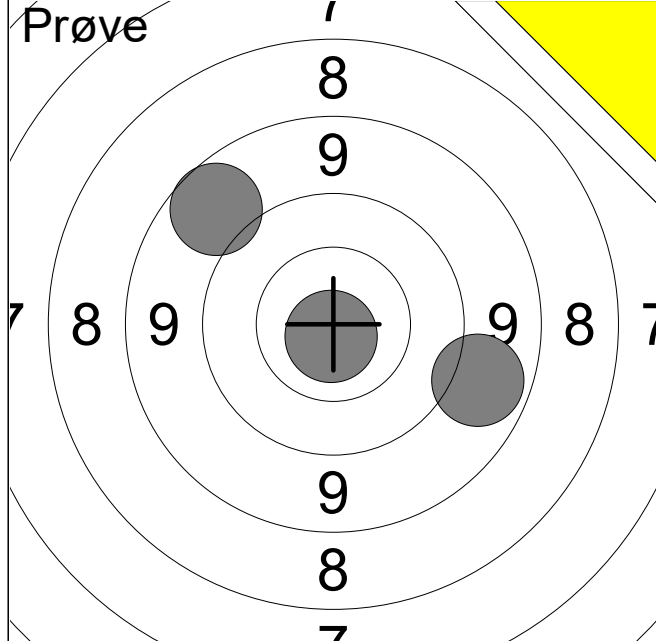

1:	8.9	↗
2:	9.0	→
3:	10.8x	↓
Serie		27 (1x)
Total		0 (0x)

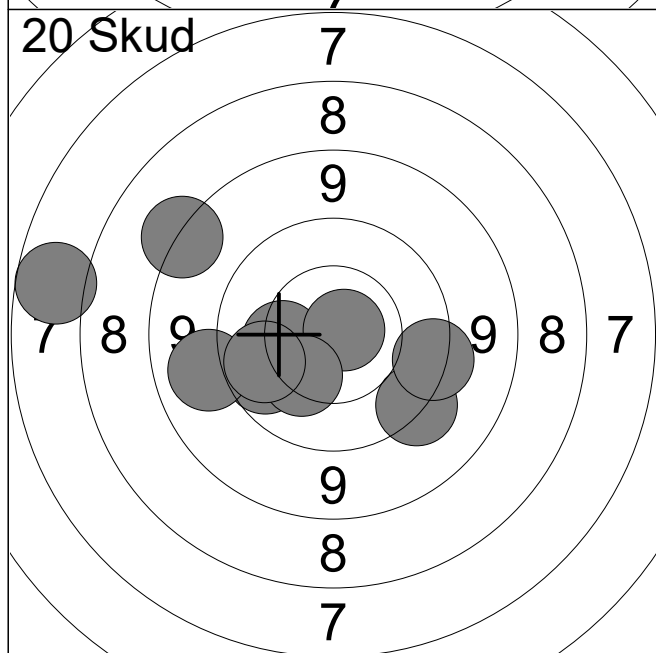

1:	10.3	←
2:	9.9	↙
3:	10.8x	↗
4:	10.3	↘
5:	9.2	←
6:	9.5	↘
7:	9.5	→
8:	10.0	←
9:	8.4	↗
10:	6.9	←
Serie		90 (1x)
Total		90 (1x)

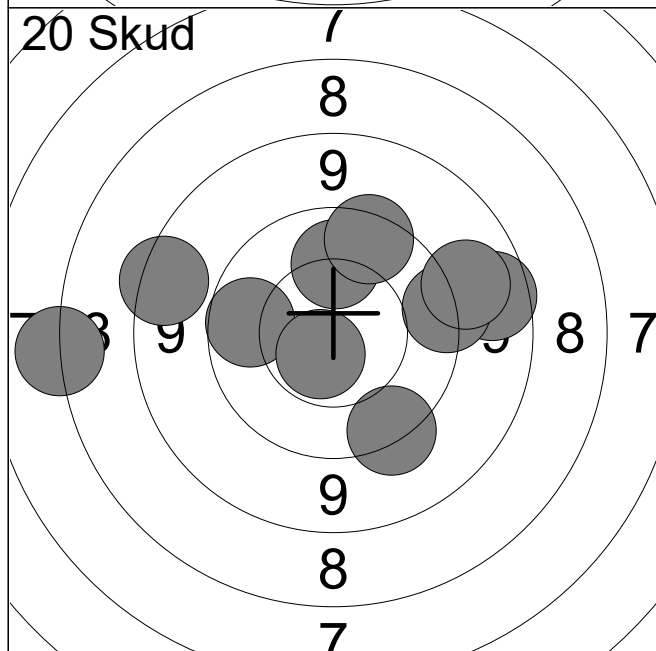

11:	10.1	↑
12:	9.5	↘
13:	9.7	↗
14:	9.9	←
15:	10.6x	↘
16:	7.3	←
17:	8.6	←
18:	8.8	→
19:	9.5	→
20:	9.1	→
Serie		88 (1x)
Total		178 (2x)

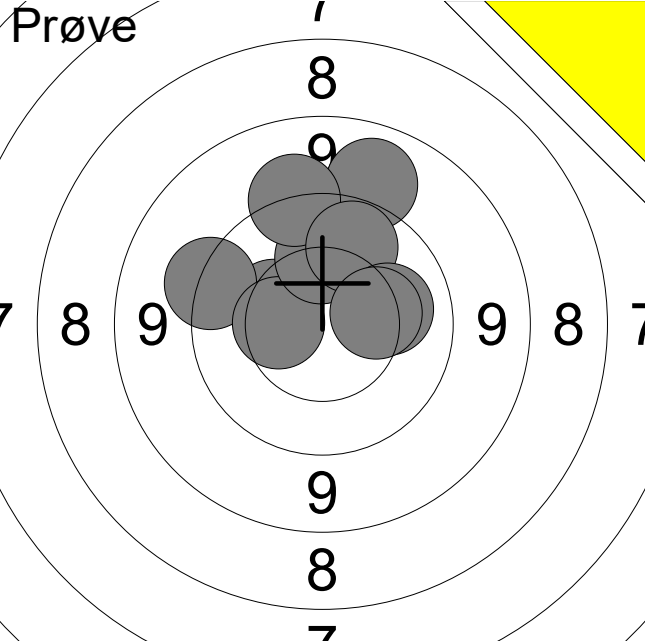
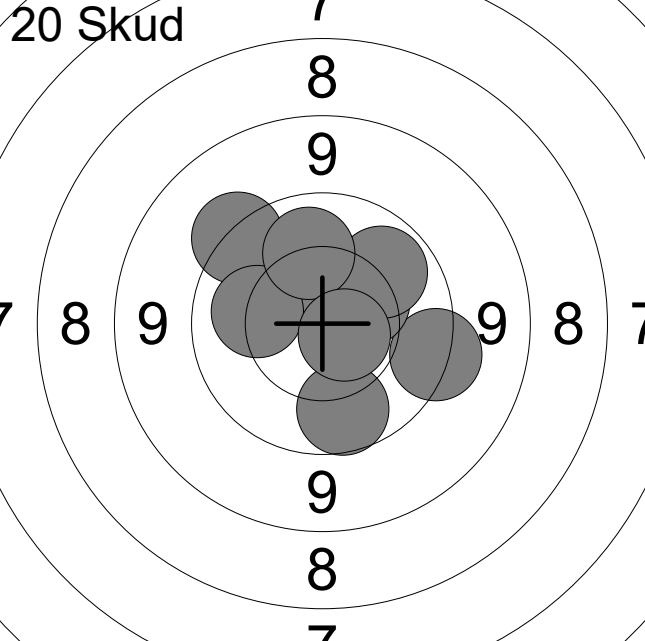
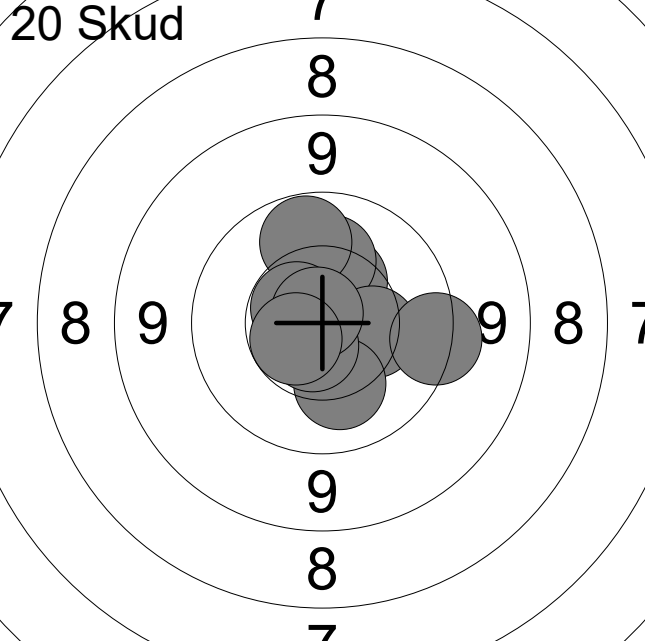
Hold 8	Skive 9	Thomas Andreassen																																
ØSF		Ølstykke Skytteforening		MÅ2																														
28.10.2024		Halloween Luftstævne 2024		Ølstykke skytteforening																														
Prøve		<table border="0"> <tr><td>1:</td><td>10.3</td><td>↖</td></tr> <tr><td>2:</td><td>9.9</td><td>↑</td></tr> <tr><td>3:</td><td>9.5</td><td>↖</td></tr> <tr><td>4:</td><td>9.1</td><td>↑</td></tr> <tr><td>5:</td><td>10.4</td><td>↖</td></tr> <tr><td>6:</td><td>10.2</td><td>↑</td></tr> <tr><td>7:</td><td>9.4</td><td>↑</td></tr> <tr><td>8:</td><td>10.0</td><td>↑</td></tr> <tr><td>9:</td><td>10.2</td><td>→</td></tr> <tr><td>10:</td><td>10.3</td><td>→</td></tr> </table>			1:	10.3	↖	2:	9.9	↑	3:	9.5	↖	4:	9.1	↑	5:	10.4	↖	6:	10.2	↑	7:	9.4	↑	8:	10.0	↑	9:	10.2	→	10:	10.3	→
1:	10.3	↖																																
2:	9.9	↑																																
3:	9.5	↖																																
4:	9.1	↑																																
5:	10.4	↖																																
6:	10.2	↑																																
7:	9.4	↑																																
8:	10.0	↑																																
9:	10.2	→																																
10:	10.3	→																																
		Serie 96 (0x)																																
		Total 0 (0x)																																
20 Skud		<table border="0"> <tr><td>1:</td><td>9.9</td><td>↓</td></tr> <tr><td>2:</td><td>9.5</td><td>→</td></tr> <tr><td>3:</td><td>10.4</td><td>↗</td></tr> <tr><td>4:</td><td>10.4</td><td>↑</td></tr> <tr><td>5:</td><td>10.4</td><td>↗</td></tr> <tr><td>6:</td><td>10.0</td><td>↗</td></tr> <tr><td>7:</td><td>9.5</td><td>↗</td></tr> <tr><td>8:</td><td>10.2</td><td>↖</td></tr> <tr><td>9:</td><td>10.1</td><td>↑</td></tr> <tr><td>10:</td><td>10.7x</td><td>↘</td></tr> </table>			1:	9.9	↓	2:	9.5	→	3:	10.4	↗	4:	10.4	↑	5:	10.4	↗	6:	10.0	↗	7:	9.5	↗	8:	10.2	↖	9:	10.1	↑	10:	10.7x	↘
1:	9.9	↓																																
2:	9.5	→																																
3:	10.4	↗																																
4:	10.4	↑																																
5:	10.4	↗																																
6:	10.0	↗																																
7:	9.5	↗																																
8:	10.2	↖																																
9:	10.1	↑																																
10:	10.7x	↘																																
		Serie 97 (1x)																																
		Total 97 (1x)																																
20 Skud		<table border="0"> <tr><td>11:</td><td>10.4</td><td>↗</td></tr> <tr><td>12:</td><td>10.2</td><td>↑</td></tr> <tr><td>13:</td><td>10.3</td><td>→</td></tr> <tr><td>14:</td><td>10.0</td><td>↑</td></tr> <tr><td>15:</td><td>10.6x</td><td>↗</td></tr> <tr><td>16:</td><td>9.6</td><td>→</td></tr> <tr><td>17:</td><td>10.2</td><td>↓</td></tr> <tr><td>18:</td><td>10.7x</td><td>↓</td></tr> <tr><td>19:</td><td>10.8x</td><td>↗</td></tr> <tr><td>20:</td><td>10.6</td><td>↖</td></tr> </table>			11:	10.4	↗	12:	10.2	↑	13:	10.3	→	14:	10.0	↑	15:	10.6x	↗	16:	9.6	→	17:	10.2	↓	18:	10.7x	↓	19:	10.8x	↗	20:	10.6	↖
11:	10.4	↗																																
12:	10.2	↑																																
13:	10.3	→																																
14:	10.0	↑																																
15:	10.6x	↗																																
16:	9.6	→																																
17:	10.2	↓																																
18:	10.7x	↓																																
19:	10.8x	↗																																
20:	10.6	↖																																
		Serie 99 (3x)																																
		Total 196 (4x)																																

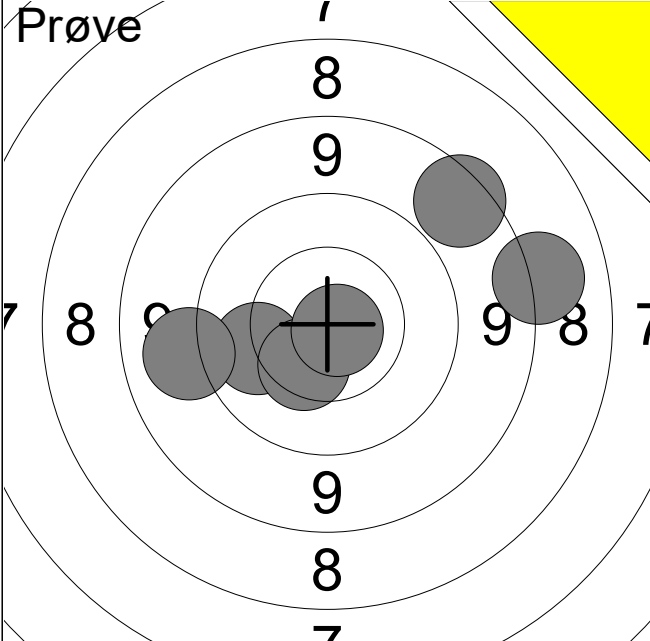
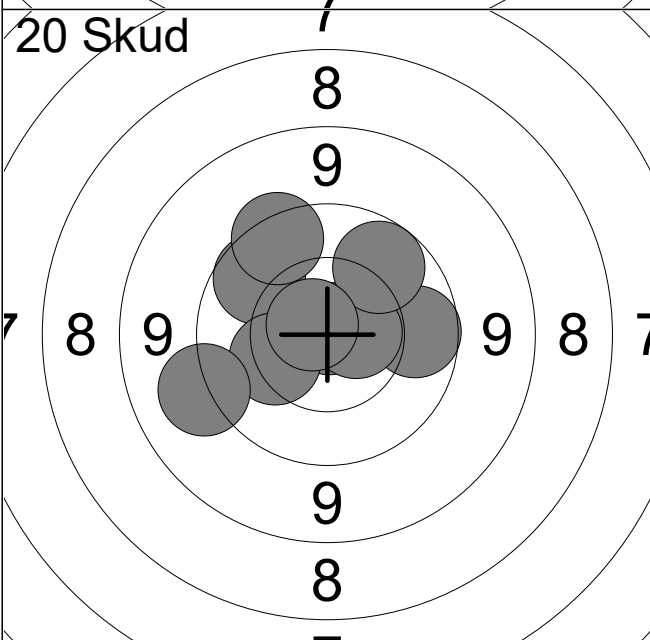
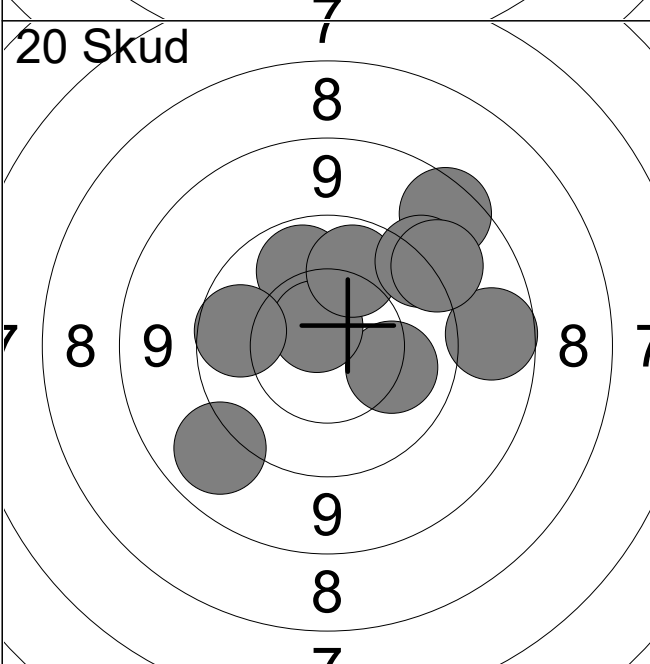
Hold 9	Skive 1	Thomas Pedersen																																
ØSF		Jørlunde Skytteforening		MST2																														
28.10.2024		Halloween Luftstævne 2024		Ølstykke skytteforening																														
Prøve		<table border="0"> <tr><td>1:</td><td>10.1</td><td>←</td></tr> <tr><td>2:</td><td>8.7</td><td>↗</td></tr> <tr><td>3:</td><td>8.2</td><td>→</td></tr> <tr><td>4:</td><td>10.4</td><td>↓</td></tr> <tr><td>5:</td><td>9.2</td><td>←</td></tr> <tr><td>6:</td><td>10.8x</td><td>↘</td></tr> </table>			1:	10.1	←	2:	8.7	↗	3:	8.2	→	4:	10.4	↓	5:	9.2	←	6:	10.8x	↘												
1:	10.1	←																																
2:	8.7	↗																																
3:	8.2	→																																
4:	10.4	↓																																
5:	9.2	←																																
6:	10.8x	↘																																
		<table border="0"> <tr><td>Serie</td><td colspan="3">55 (1x)</td></tr> <tr><td>Total</td><td colspan="3">0 (0x)</td></tr> </table>			Serie	55 (1x)			Total	0 (0x)																								
Serie	55 (1x)																																	
Total	0 (0x)																																	
20 Skud		<table border="0"> <tr><td>1:</td><td>10.9x</td><td>↑</td></tr> <tr><td>2:</td><td>10.6x</td><td>←</td></tr> <tr><td>3:</td><td>9.9</td><td>↗</td></tr> <tr><td>4:</td><td>9.9</td><td>→</td></tr> <tr><td>5:</td><td>10.3</td><td>←</td></tr> <tr><td>6:</td><td>9.6</td><td>↑</td></tr> <tr><td>7:</td><td>10.6x</td><td>→</td></tr> <tr><td>8:</td><td>9.9</td><td>↗</td></tr> <tr><td>9:</td><td>9.3</td><td>←</td></tr> <tr><td>10:</td><td>10.7x</td><td>↖</td></tr> </table>			1:	10.9x	↑	2:	10.6x	←	3:	9.9	↗	4:	9.9	→	5:	10.3	←	6:	9.6	↑	7:	10.6x	→	8:	9.9	↗	9:	9.3	←	10:	10.7x	↖
1:	10.9x	↑																																
2:	10.6x	←																																
3:	9.9	↗																																
4:	9.9	→																																
5:	10.3	←																																
6:	9.6	↑																																
7:	10.6x	→																																
8:	9.9	↗																																
9:	9.3	←																																
10:	10.7x	↖																																
		<table border="0"> <tr><td>Serie</td><td colspan="3">95 (4x)</td></tr> <tr><td>Total</td><td colspan="3">95 (4x)</td></tr> </table>			Serie	95 (4x)			Total	95 (4x)																								
Serie	95 (4x)																																	
Total	95 (4x)																																	
20 Skud		<table border="0"> <tr><td>11:</td><td>10.2</td><td>→</td></tr> <tr><td>12:</td><td>8.7</td><td>↗</td></tr> <tr><td>13:</td><td>10.0</td><td>↑</td></tr> <tr><td>14:</td><td>9.1</td><td>↙</td></tr> <tr><td>15:</td><td>10.7x</td><td>↖</td></tr> <tr><td>16:</td><td>10.0</td><td>↑</td></tr> <tr><td>17:</td><td>9.4</td><td>↗</td></tr> <tr><td>18:</td><td>8.9</td><td>→</td></tr> <tr><td>19:</td><td>9.9</td><td>←</td></tr> <tr><td>20:</td><td>9.3</td><td>↗</td></tr> </table>			11:	10.2	→	12:	8.7	↗	13:	10.0	↑	14:	9.1	↙	15:	10.7x	↖	16:	10.0	↑	17:	9.4	↗	18:	8.9	→	19:	9.9	←	20:	9.3	↗
11:	10.2	→																																
12:	8.7	↗																																
13:	10.0	↑																																
14:	9.1	↙																																
15:	10.7x	↖																																
16:	10.0	↑																																
17:	9.4	↗																																
18:	8.9	→																																
19:	9.9	←																																
20:	9.3	↗																																
		<table border="0"> <tr><td>Serie</td><td colspan="3">92 (1x)</td></tr> <tr><td>Total</td><td colspan="3">187 (5x)</td></tr> </table>			Serie	92 (1x)			Total	187 (5x)																								
Serie	92 (1x)																																	
Total	187 (5x)																																	

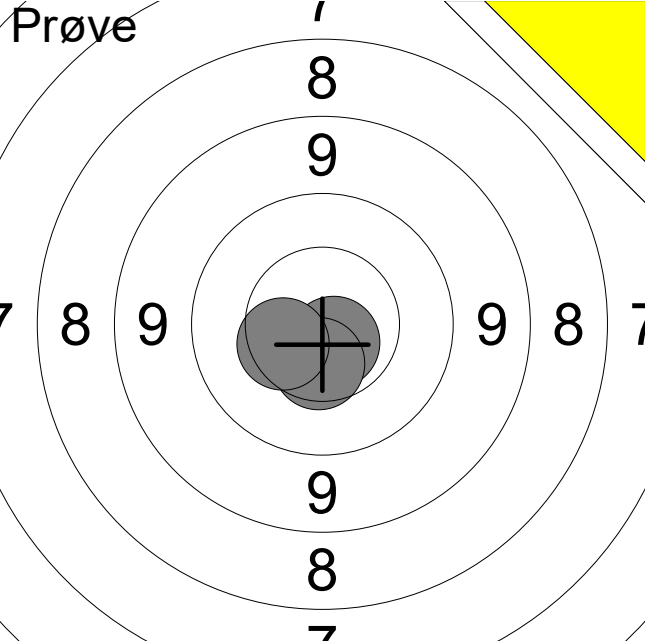
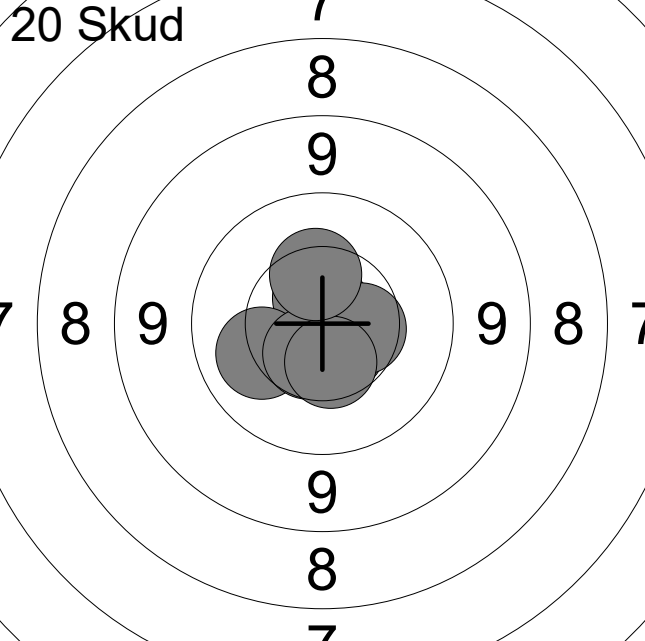
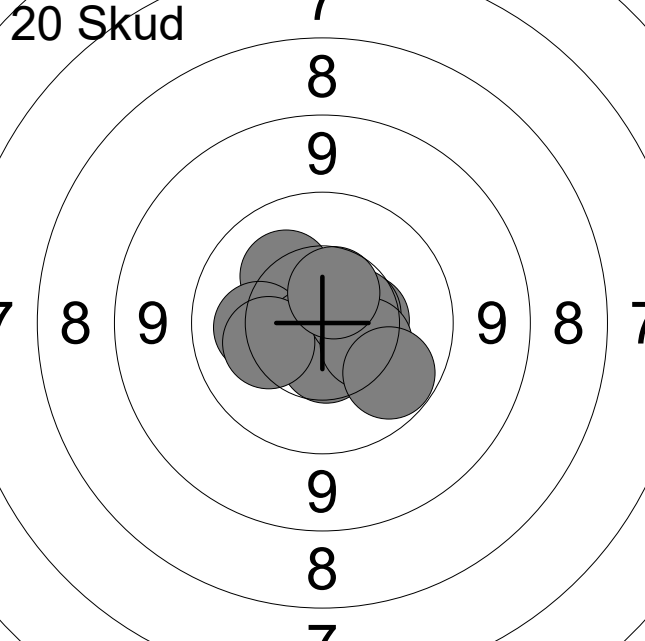
Hold 9	Skive 6	Bjarne Binder		
ØSF		Ølstykke Skytteforening		MÅ1
28.10.2024		Halloween Luftstævne 2024		Ølstykke skytteforening
Prøve		1: 10.7x ↘ 2: 10.5 ↓ 3: 10.4 ↙		
		Serie 30 (1x) Total 0 (0x)		
20 Skud		1: 10.7x → 2: 10.7x ↓ 3: 10.6x ↑ 4: 10.6x ↓ 5: 10.2 ↙ 6: 10.8x → 7: 10.6 ↓ 8: 10.5 → 9: 10.5 ↓ 10: 10.4 ↑		
		Serie 100 (5x) Total 100 (5x)		
20 Skud		11: 10.2 ↗ 12: 10.2 ← 13: 10.8x ↙ 14: 10.5 ↓ 15: 10.5 → 16: 10.3 ↙ 17: 10.6 → 18: 10.4 ↘ 19: 10.6 ↑ 20: 10.0 ↘		
		Serie 100 (1x) Total 200 (6x)		

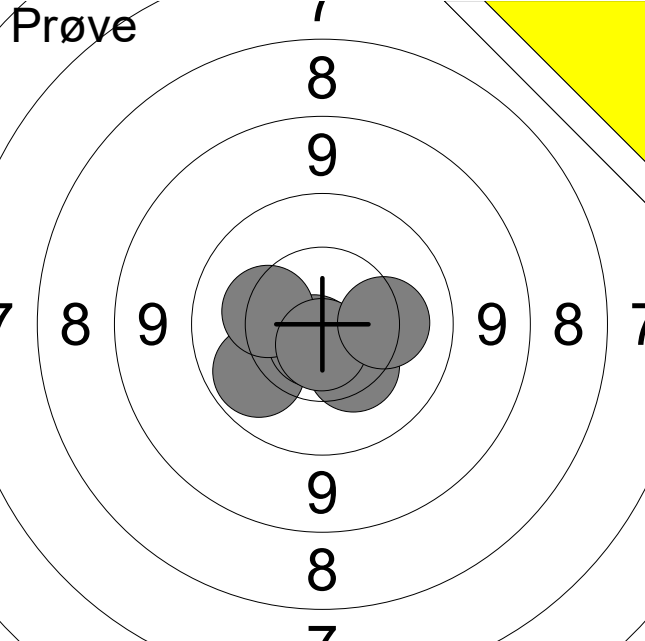
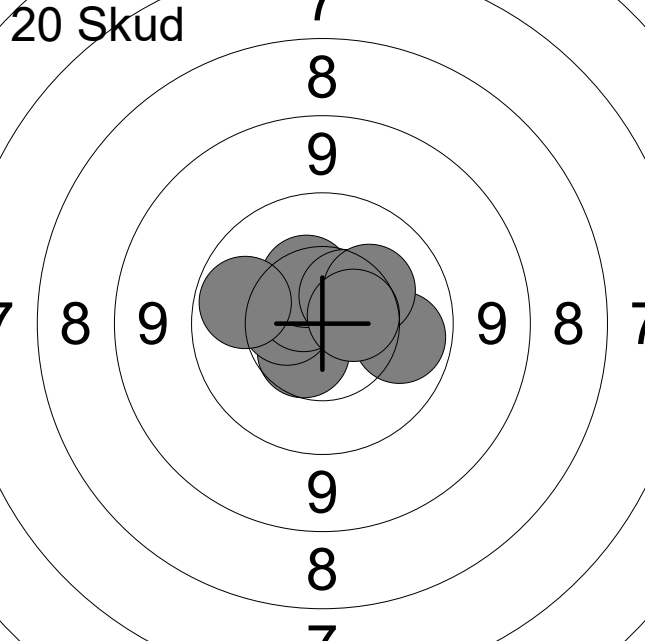
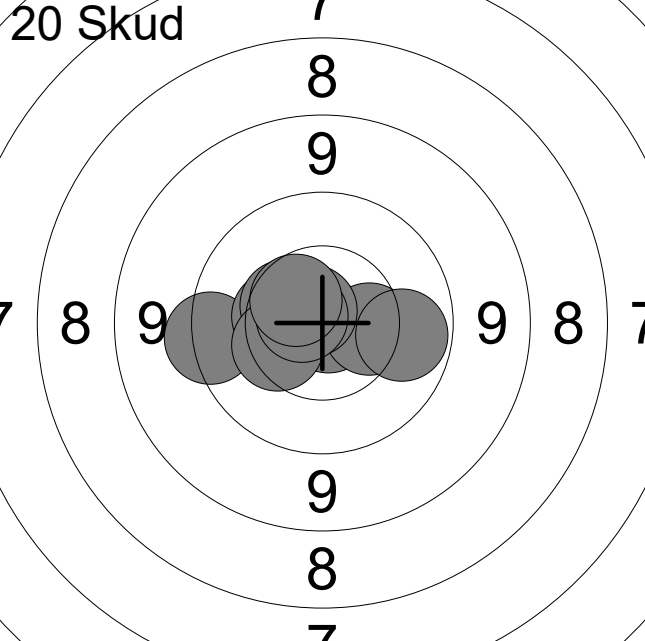
Hold 9	Skive 11	Bjoern Thomsen																																
ØSF		Ganløse Skytteforening		MÅ2																														
28.10.2024		Halloween Luftstævne 2024		Ølstykke skytteforening																														
Prøve		<table border="0"> <tr><td>1:</td><td>10.0</td><td>↙</td></tr> <tr><td>2:</td><td>10.7x</td><td>↓</td></tr> <tr><td>3:</td><td>10.3</td><td>↘</td></tr> <tr><td>4:</td><td>10.3</td><td>←</td></tr> <tr><td>5:</td><td>10.7x</td><td>↓</td></tr> <tr><td>6:</td><td>10.2</td><td>→</td></tr> </table>			1:	10.0	↙	2:	10.7x	↓	3:	10.3	↘	4:	10.3	←	5:	10.7x	↓	6:	10.2	→												
1:	10.0	↙																																
2:	10.7x	↓																																
3:	10.3	↘																																
4:	10.3	←																																
5:	10.7x	↓																																
6:	10.2	→																																
		Serie 60 (2x)																																
		Total 0 (0x)																																
20 Skud		<table border="0"> <tr><td>1:</td><td>10.6</td><td>↙</td></tr> <tr><td>2:</td><td>10.5</td><td>↑</td></tr> <tr><td>3:</td><td>10.5</td><td>←</td></tr> <tr><td>4:</td><td>10.6x</td><td>↗</td></tr> <tr><td>5:</td><td>10.4</td><td>↑</td></tr> <tr><td>6:</td><td>10.0</td><td>←</td></tr> <tr><td>7:</td><td>10.0</td><td>→</td></tr> <tr><td>8:</td><td>10.5</td><td>↗</td></tr> <tr><td>9:</td><td>10.3</td><td>↗</td></tr> <tr><td>10:</td><td>10.6</td><td>→</td></tr> </table>			1:	10.6	↙	2:	10.5	↑	3:	10.5	←	4:	10.6x	↗	5:	10.4	↑	6:	10.0	←	7:	10.0	→	8:	10.5	↗	9:	10.3	↗	10:	10.6	→
1:	10.6	↙																																
2:	10.5	↑																																
3:	10.5	←																																
4:	10.6x	↗																																
5:	10.4	↑																																
6:	10.0	←																																
7:	10.0	→																																
8:	10.5	↗																																
9:	10.3	↗																																
10:	10.6	→																																
		Serie 100 (1x)																																
		Total 100 (1x)																																
20 Skud		<table border="0"> <tr><td>11:</td><td>10.9x</td><td>↘</td></tr> <tr><td>12:</td><td>9.6</td><td>←</td></tr> <tr><td>13:</td><td>10.4</td><td>←</td></tr> <tr><td>14:</td><td>10.4</td><td>→</td></tr> <tr><td>15:</td><td>10.8x</td><td>↗</td></tr> <tr><td>16:</td><td>10.0</td><td>→</td></tr> <tr><td>17:</td><td>10.5</td><td>↗</td></tr> <tr><td>18:</td><td>10.4</td><td>←</td></tr> <tr><td>19:</td><td>10.7x</td><td>←</td></tr> <tr><td>20:</td><td>10.5</td><td>↗</td></tr> </table>			11:	10.9x	↘	12:	9.6	←	13:	10.4	←	14:	10.4	→	15:	10.8x	↗	16:	10.0	→	17:	10.5	↗	18:	10.4	←	19:	10.7x	←	20:	10.5	↗
11:	10.9x	↘																																
12:	9.6	←																																
13:	10.4	←																																
14:	10.4	→																																
15:	10.8x	↗																																
16:	10.0	→																																
17:	10.5	↗																																
18:	10.4	←																																
19:	10.7x	←																																
20:	10.5	↗																																
		Serie 99 (3x)																																
		Total 199 (4x)																																

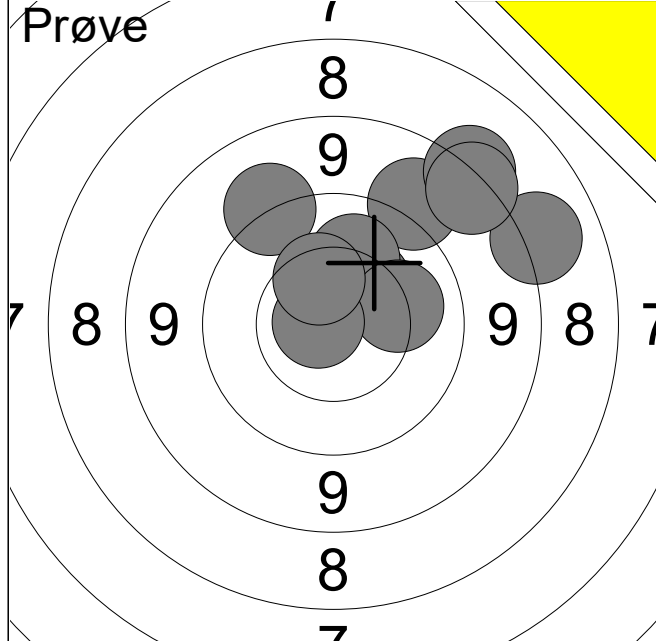

1:	8.2	→
2:	9.2	↗
3:	8.4	↗
4:	8.5	↗
5:	10.3	↗
6:	10.1	↗
7:	9.3	↖
8:	10.2	→
9:	10.8x	←
10:	10.4	↖
Serie		92 (1x)
Total		0 (0x)

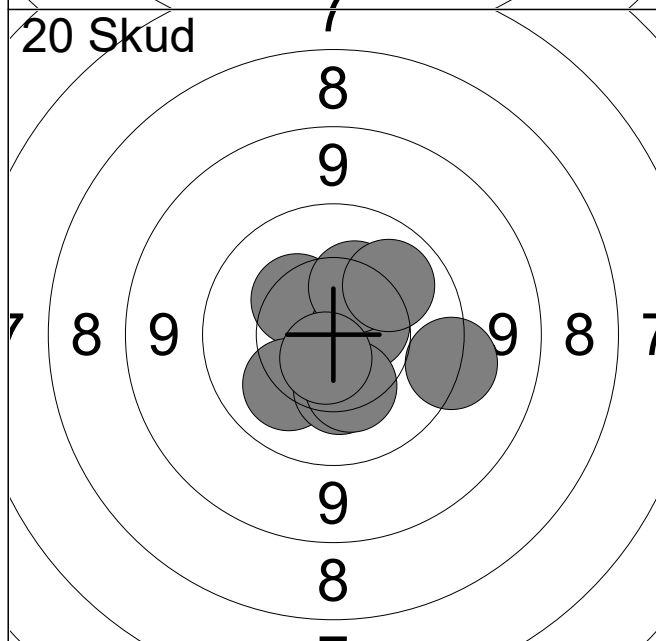

1:	10.4	↖
2:	10.7x	→
3:	10.2	↘
4:	10.6	→
5:	9.5	→
6:	10.3	↗
7:	10.1	↗
8:	10.3	↘
9:	10.3	↘
10:	10.7x	↘
Serie		99 (2x)
Total		99 (2x)

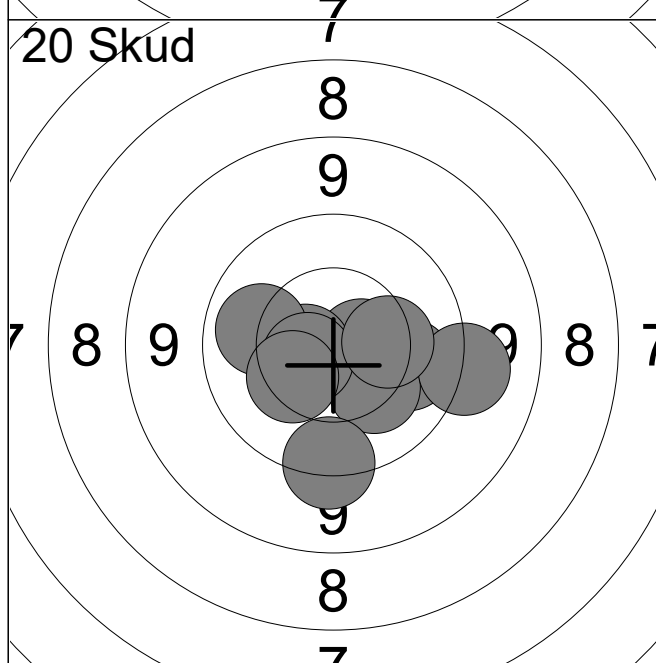

11:	10.6x	→
12:	10.6x	←
13:	10.0	→
14:	10.1	←
15:	10.2	↘
16:	9.3	→
17:	10.6x	←
18:	10.3	→
19:	9.5	↘
20:	10.3	↘
Serie		98 (3x)
Total		197 (5x)

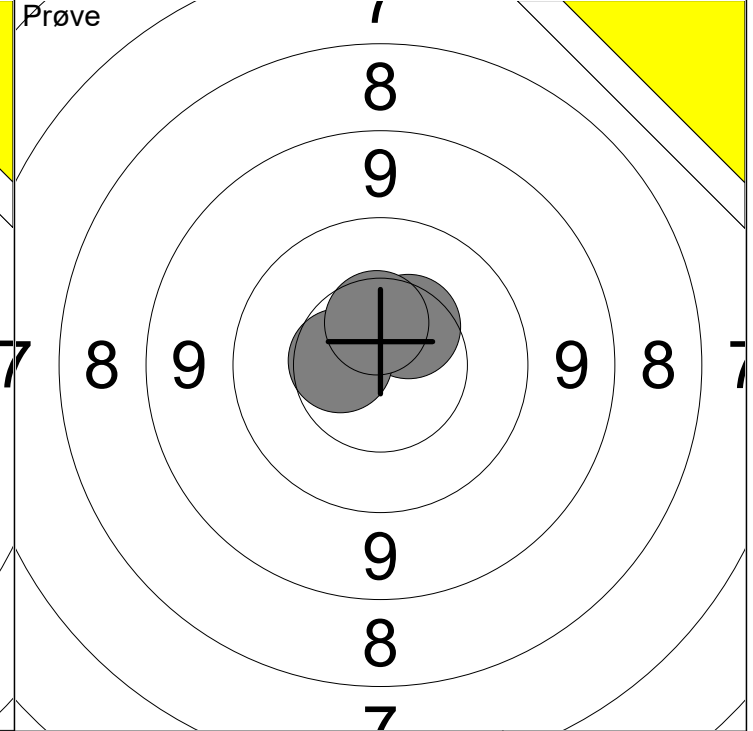
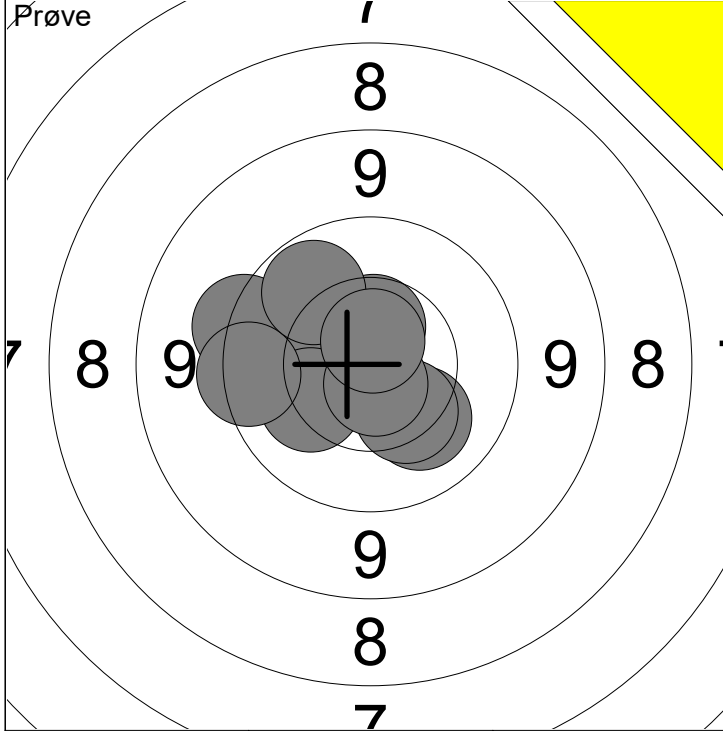

1: 10.2 ↘	6: 9.6 ←	Serie 98 (2x)
2: 10.3 ↘	7: 10.7x ↓	
3: 9.5 ↗	8: 10.6 ↑	Total 0 (0x)
4: 10.5 ←	9: 10.0 ↗	
5: 10.2 ↙	10: 10.7x ↑	

11: 10.5 ↗	Serie 30 (0x)
12: 10.5 ←	
13: 10.5 ↑	Total 0 (0x)

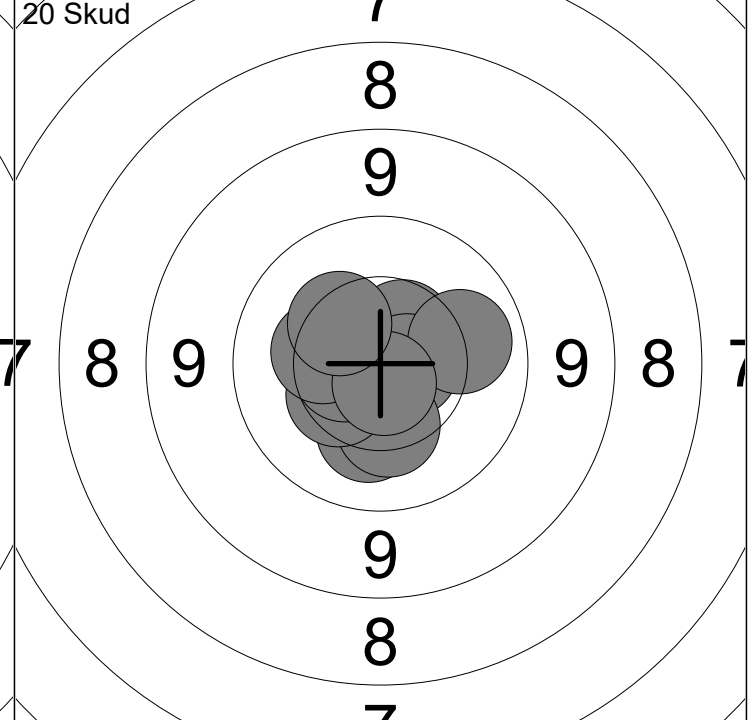
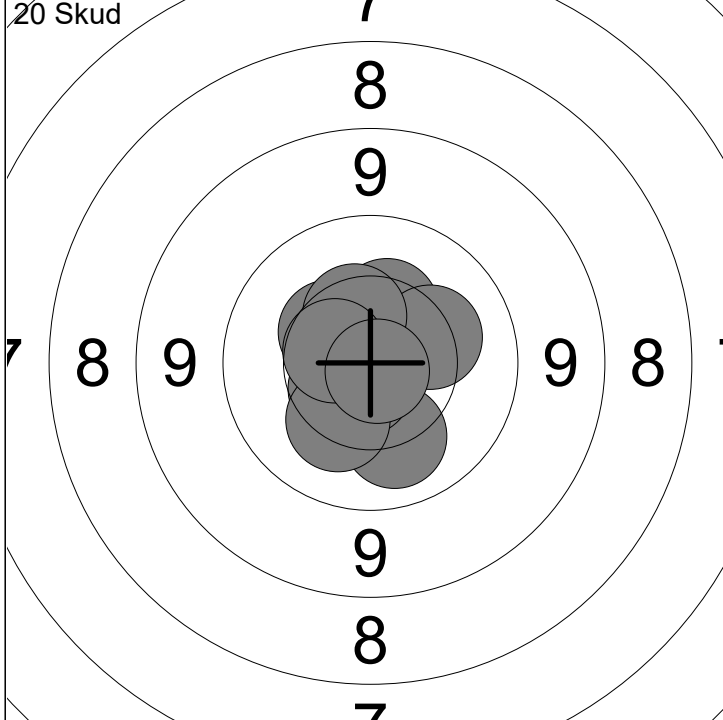

1: 10.4 ↗	6: 10.7x ↓	Serie 100 (2x)
2: 10.4 ↖	7: 10.4 ↗	
3: 10.5 ↙	8: 10.3 ↓	Total 100 (2x)
4: 10.1 ↓	9: 10.6 ←	
5: 10.3 ↗	10: 10.8x ↓	

11: 10.5 ↗	16: 10.1 →	Serie 100 (2x)
12: 10.7x →	17: 10.6 ←	
13: 10.2 ↓	18: 10.3 ←	Total 200 (4x)
14: 10.3 ↓	19: 10.7x ↓	
15: 10.4 ↙	20: 10.3 ↖	

Hold	Skive	Anders Langhorn		
10	5	Helsing S&i - Skytteafd.		SE1
ØSF	Halloween Luftstævne 2024		Ølstykke skytteforening	
28.10.2024				
Prøve		1:	9.6	↓
		2:	10.4	↙
		3:	10.4	→
		4:	9.6	↓
		5:	10.7x	←
		6:	10.8x	↘
		Serie		
Total			0 (0x)	
20 Skud		1:	10.2	↓
		2:	10.3	↓
		3:	9.9	↙
		4:	10.5	↓
		5:	10.3	↑
		6:	10.5	↗
		7:	10.8x	↓
		8:	10.2	↓
		9:	9.7	↗
		10:	9.8	←
Serie			97 (1x)	
Total			97 (1x)	
20 Skud		11:	10.9x	↗
		12:	10.4	↑
		13:	10.5	↓
		14:	10.7x	↑
		15:	10.4	→
		16:	10.1	↑
		17:	10.3	↑
		18:	10.4	↓
		19:	10.4	↙
		20:	9.9	↗
Serie			99 (2x)	
Total			196 (3x)	

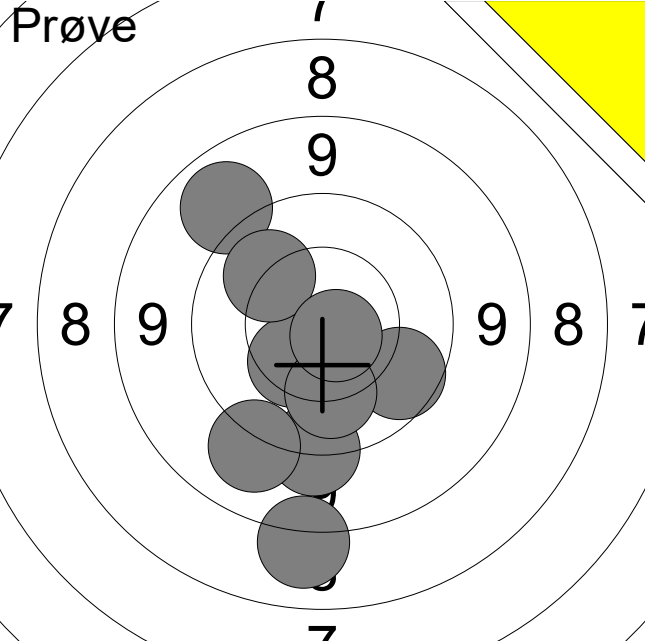
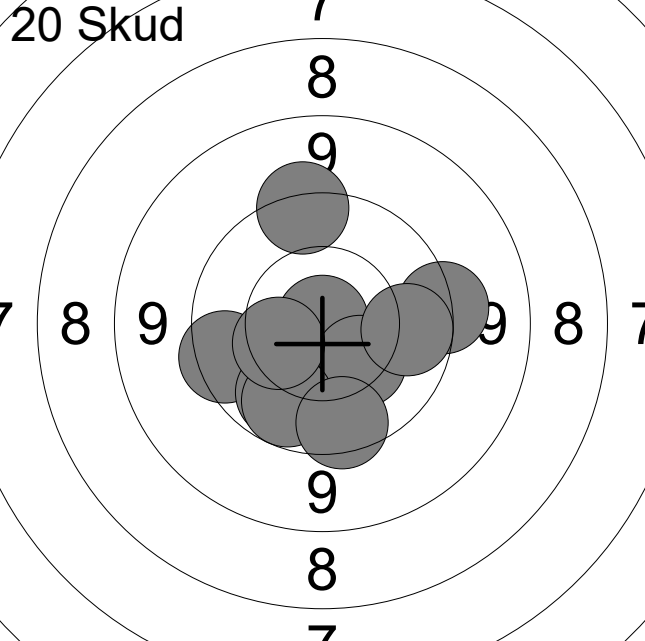
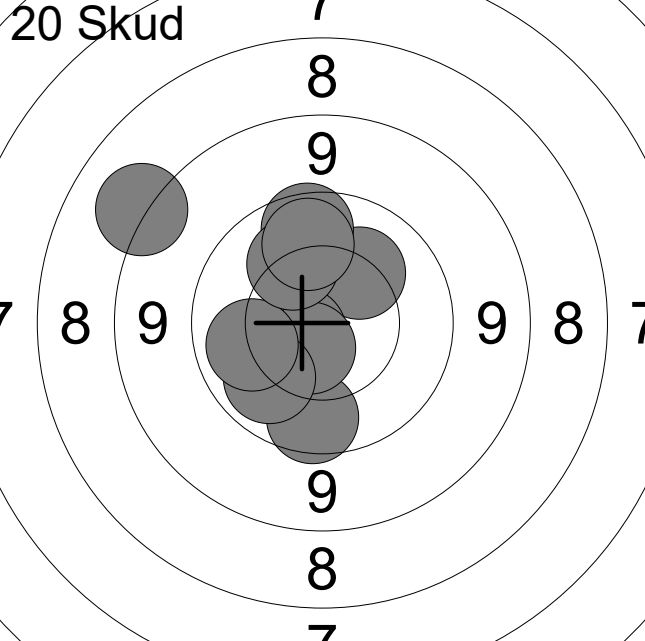
Hold 10	Skive 8	Anne Illum Andersen																																
ØSF		Frederikssund Skytteforening, I		Å2																														
28.10.2024		Halloween Luftstævne 2024		Ølstykke skytteforening																														
Prøve		<table border="0"> <tr><td>1:</td><td>8.2</td><td>↓</td></tr> <tr><td>2:</td><td>9.9</td><td>↘</td></tr> <tr><td>3:</td><td>9.4</td><td>↓</td></tr> <tr><td>4:</td><td>10.4</td><td>↘</td></tr> <tr><td>5:</td><td>9.2</td><td>↘</td></tr> <tr><td>6:</td><td>10.1</td><td>↓</td></tr> <tr><td>7:</td><td>9.1</td><td>↗</td></tr> <tr><td>8:</td><td>10.1</td><td>↗</td></tr> <tr><td>9:</td><td>10.7x</td><td>↘</td></tr> </table>			1:	8.2	↓	2:	9.9	↘	3:	9.4	↓	4:	10.4	↘	5:	9.2	↘	6:	10.1	↓	7:	9.1	↗	8:	10.1	↗	9:	10.7x	↘			
1:	8.2	↓																																
2:	9.9	↘																																
3:	9.4	↓																																
4:	10.4	↘																																
5:	9.2	↘																																
6:	10.1	↓																																
7:	9.1	↗																																
8:	10.1	↗																																
9:	10.7x	↘																																
		Serie 84 (1x)																																
		Total 0 (0x)																																
20 Skud		<table border="0"> <tr><td>1:</td><td>9.7</td><td>←</td></tr> <tr><td>2:</td><td>10.9x</td><td>↑</td></tr> <tr><td>3:</td><td>10.3</td><td>↘</td></tr> <tr><td>4:</td><td>10.0</td><td>↘</td></tr> <tr><td>5:</td><td>9.5</td><td>→</td></tr> <tr><td>6:</td><td>9.9</td><td>↘</td></tr> <tr><td>7:</td><td>10.4</td><td>←</td></tr> <tr><td>8:</td><td>9.9</td><td>→</td></tr> <tr><td>9:</td><td>9.7</td><td>↓</td></tr> <tr><td>10:</td><td>9.5</td><td>↑</td></tr> </table>			1:	9.7	←	2:	10.9x	↑	3:	10.3	↘	4:	10.0	↘	5:	9.5	→	6:	9.9	↘	7:	10.4	←	8:	9.9	→	9:	9.7	↓	10:	9.5	↑
1:	9.7	←																																
2:	10.9x	↑																																
3:	10.3	↘																																
4:	10.0	↘																																
5:	9.5	→																																
6:	9.9	↘																																
7:	10.4	←																																
8:	9.9	→																																
9:	9.7	↓																																
10:	9.5	↑																																
		Serie 94 (1x)																																
		Total 94 (1x)																																
20 Skud		<table border="0"> <tr><td>11:</td><td>10.2</td><td>↗</td></tr> <tr><td>12:</td><td>10.7x</td><td>←</td></tr> <tr><td>13:</td><td>9.8</td><td>↓</td></tr> <tr><td>14:</td><td>10.6x</td><td>↘</td></tr> <tr><td>15:</td><td>10.1</td><td>↘</td></tr> <tr><td>16:</td><td>9.8</td><td>↑</td></tr> <tr><td>17:</td><td>10.1</td><td>←</td></tr> <tr><td>18:</td><td>8.3</td><td>↗</td></tr> <tr><td>19:</td><td>10.2</td><td>↗</td></tr> <tr><td>20:</td><td>10.0</td><td>↑</td></tr> </table>			11:	10.2	↗	12:	10.7x	←	13:	9.8	↓	14:	10.6x	↘	15:	10.1	↘	16:	9.8	↑	17:	10.1	←	18:	8.3	↗	19:	10.2	↗	20:	10.0	↑
11:	10.2	↗																																
12:	10.7x	←																																
13:	9.8	↓																																
14:	10.6x	↘																																
15:	10.1	↘																																
16:	9.8	↑																																
17:	10.1	←																																
18:	8.3	↗																																
19:	10.2	↗																																
20:	10.0	↑																																
		Serie 96 (2x)																																
		Total 190 (3x)																																

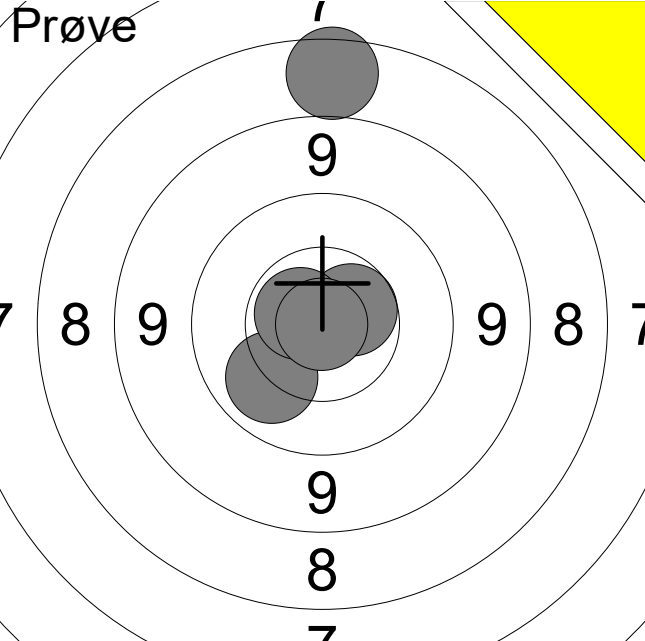
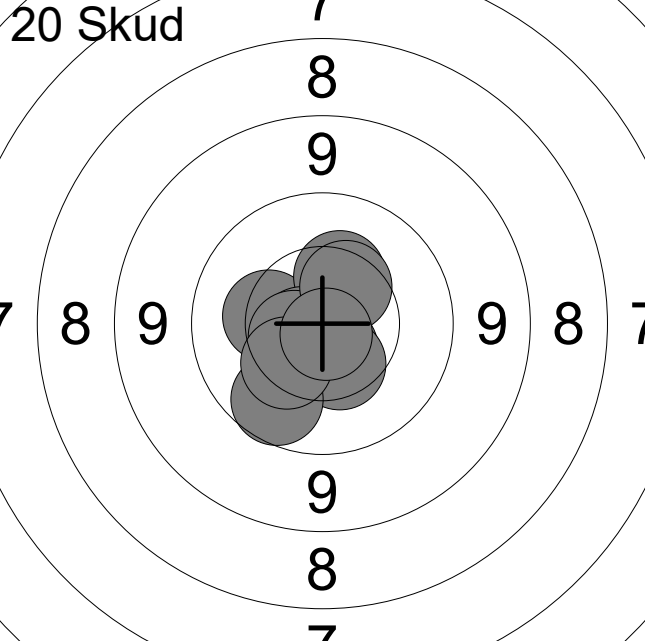
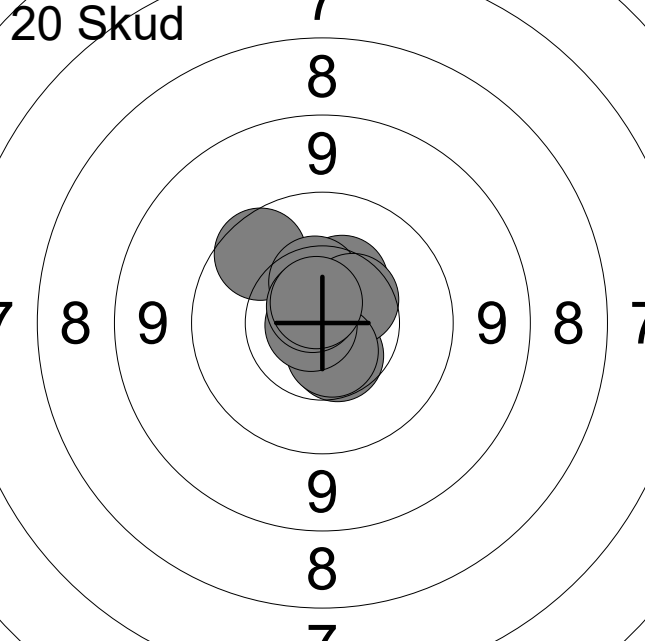
Hold 10	Skive 10	Sandra Youden																																
ØSF		Frederikssund Skytteforening, I		Å1																														
28.10.2024		Halloween Luftstævne 2024		Ølstykke skytteforening																														
Prøve		<table border="0"> <tr><td>1:</td><td>7.8</td><td>↑</td></tr> <tr><td>2:</td><td>10.1</td><td>↙</td></tr> <tr><td>3:</td><td>10.6</td><td>→</td></tr> <tr><td>4:</td><td>10.7x</td><td>↖</td></tr> <tr><td>5:</td><td>10.9x</td><td>↖</td></tr> </table>			1:	7.8	↑	2:	10.1	↙	3:	10.6	→	4:	10.7x	↖	5:	10.9x	↖															
1:	7.8	↑																																
2:	10.1	↙																																
3:	10.6	→																																
4:	10.7x	↖																																
5:	10.9x	↖																																
		<table border="0"> <tr><td>Serie</td><td colspan="2">47 (2x)</td></tr> <tr><td>Total</td><td colspan="2">0 (0x)</td></tr> </table>			Serie	47 (2x)		Total	0 (0x)																									
Serie	47 (2x)																																	
Total	0 (0x)																																	
20 Skud		<table border="0"> <tr><td>1:</td><td>10.6x</td><td>↓</td></tr> <tr><td>2:</td><td>10.3</td><td>←</td></tr> <tr><td>3:</td><td>10.4</td><td>↓</td></tr> <tr><td>4:</td><td>10.4</td><td>↑</td></tr> <tr><td>5:</td><td>10.7x</td><td>↖</td></tr> <tr><td>6:</td><td>9.9</td><td>↓</td></tr> <tr><td>7:</td><td>10.6x</td><td>←</td></tr> <tr><td>8:</td><td>10.3</td><td>↙</td></tr> <tr><td>9:</td><td>10.4</td><td>↗</td></tr> <tr><td>10:</td><td>10.8x</td><td>↓</td></tr> </table>			1:	10.6x	↓	2:	10.3	←	3:	10.4	↓	4:	10.4	↑	5:	10.7x	↖	6:	9.9	↓	7:	10.6x	←	8:	10.3	↙	9:	10.4	↗	10:	10.8x	↓
1:	10.6x	↓																																
2:	10.3	←																																
3:	10.4	↓																																
4:	10.4	↑																																
5:	10.7x	↖																																
6:	9.9	↓																																
7:	10.6x	←																																
8:	10.3	↙																																
9:	10.4	↗																																
10:	10.8x	↓																																
		<table border="0"> <tr><td>Serie</td><td colspan="2">99 (4x)</td></tr> <tr><td>Total</td><td colspan="2">99 (4x)</td></tr> </table>			Serie	99 (4x)		Total	99 (4x)																									
Serie	99 (4x)																																	
Total	99 (4x)																																	
20 Skud		<table border="0"> <tr><td>11:</td><td>10.9x</td><td>→</td></tr> <tr><td>12:</td><td>10.5</td><td>↓</td></tr> <tr><td>13:</td><td>10.4</td><td>↑</td></tr> <tr><td>14:</td><td>9.8</td><td>↗</td></tr> <tr><td>15:</td><td>10.5</td><td>↑</td></tr> <tr><td>16:</td><td>10.5</td><td>↗</td></tr> <tr><td>17:</td><td>10.6x</td><td>↓</td></tr> <tr><td>18:</td><td>10.8x</td><td>←</td></tr> <tr><td>19:</td><td>10.7x</td><td>↗</td></tr> <tr><td>20:</td><td>10.7x</td><td>↑</td></tr> </table>			11:	10.9x	→	12:	10.5	↓	13:	10.4	↑	14:	9.8	↗	15:	10.5	↑	16:	10.5	↗	17:	10.6x	↓	18:	10.8x	←	19:	10.7x	↗	20:	10.7x	↑
11:	10.9x	→																																
12:	10.5	↓																																
13:	10.4	↑																																
14:	9.8	↗																																
15:	10.5	↑																																
16:	10.5	↗																																
17:	10.6x	↓																																
18:	10.8x	←																																
19:	10.7x	↗																																
20:	10.7x	↑																																
		<table border="0"> <tr><td>Serie</td><td colspan="2">99 (5x)</td></tr> <tr><td>Total</td><td colspan="2">198 (9x)</td></tr> </table>			Serie	99 (5x)		Total	198 (9x)																									
Serie	99 (5x)																																	
Total	198 (9x)																																	

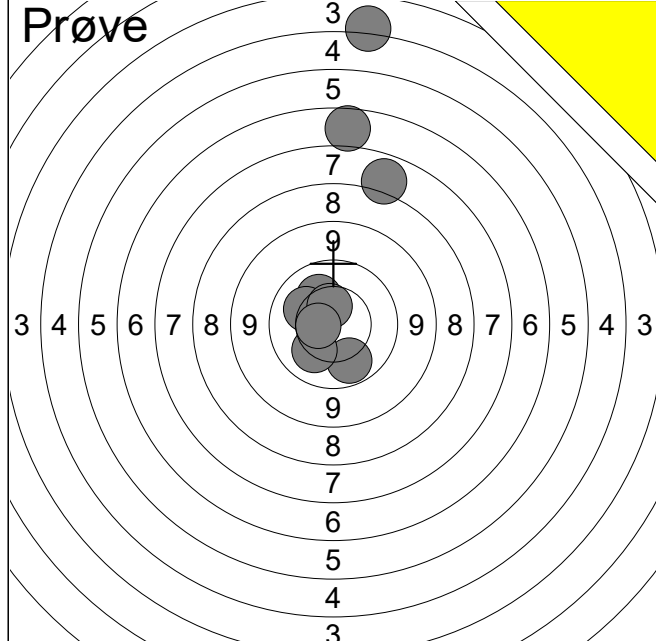

1:	3.2	↑
2:	5.9	↑
3:	7.1	↑
4:	10.0	↓
5:	10.2	↑
6:	10.2	↖
7:	10.2	↙
8:	10.5	↑
9:	10.6x	←
Serie		75 (1x)
Total		0 (0x)

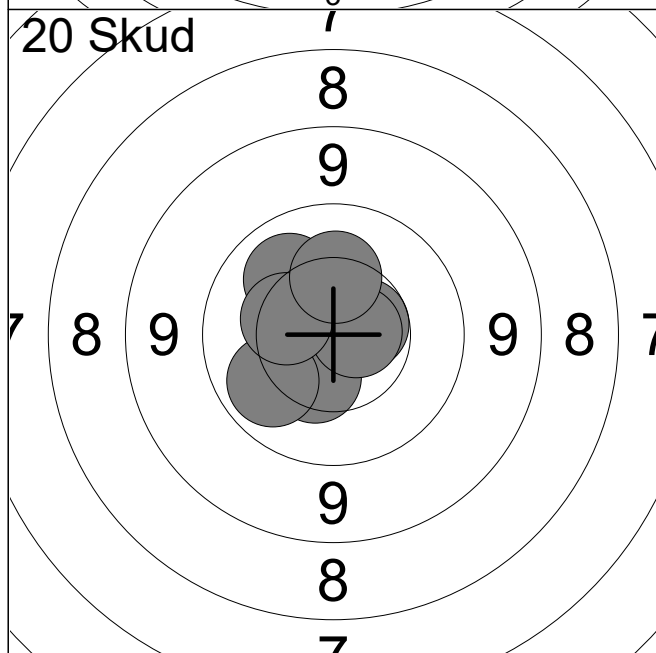

1:	10.6	→
2:	10.7x	←
3:	10.6x	↙
4:	10.5	↖
5:	10.4	↘
6:	10.1	↑
7:	10.7x	→
8:	10.0	↙
9:	10.4	←
10:	10.3	↑
Serie		100 (3x)
Total		100 (3x)

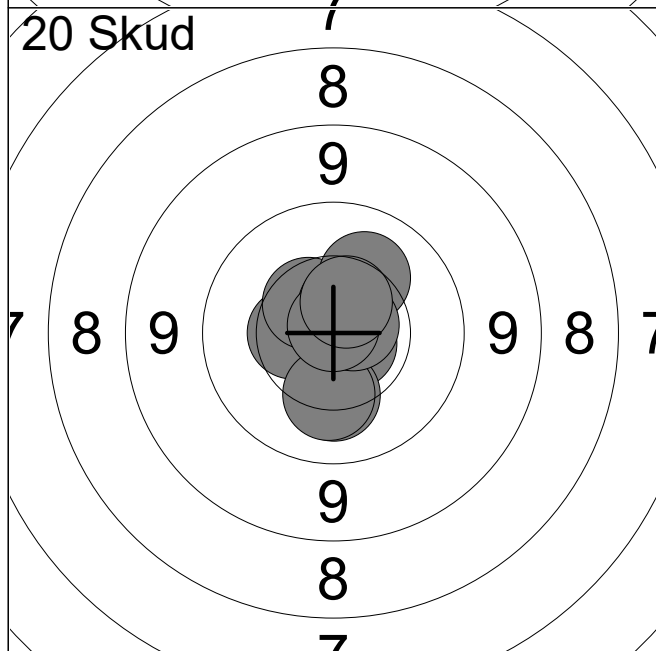

11:	10.7x	↘
12:	10.2	↓
13:	10.5	←
14:	10.5	↖
15:	10.6x	↑
16:	10.2	↗
17:	10.2	↓
18:	10.7x	→
19:	10.9x	↑
20:	10.6	↑
Serie		100 (4x)
Total		200 (7x)

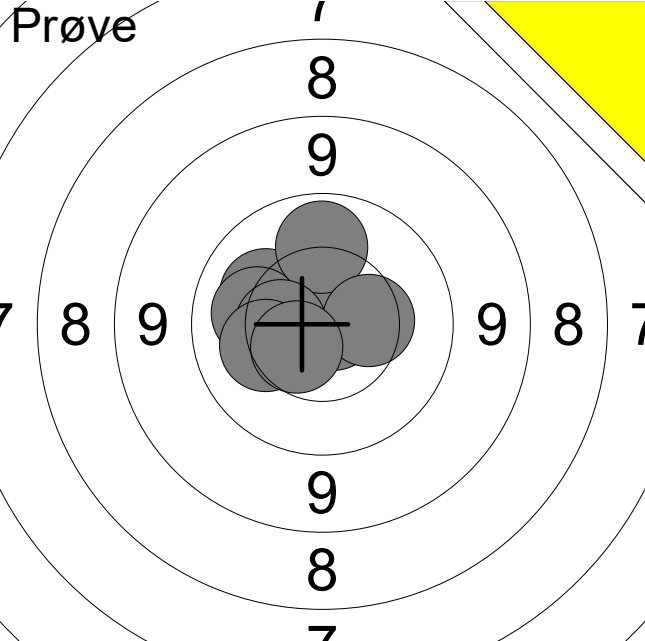
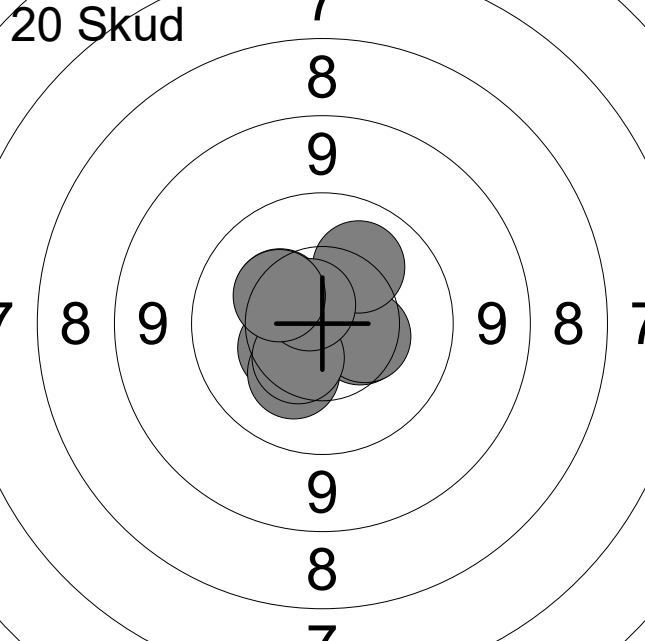
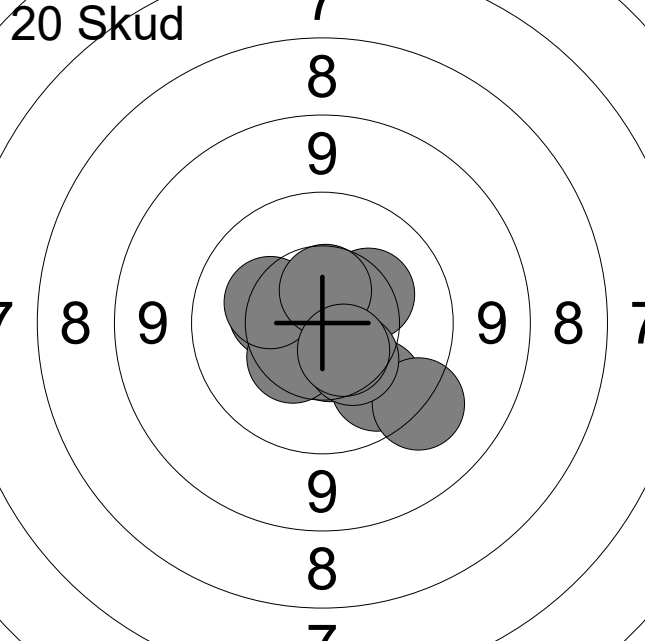
Hold	Skive	Anders Langhorn																																
11	5	Helsing S&i - Skytteafd.		MSE1																														
28.10.2024		Halloween Luftstævne 2024		Ølstykke skytteforening																														
Prøve		<table border="0"> <tr><td>1:</td><td>10.8x</td><td>→</td></tr> <tr><td>2:</td><td>10.2</td><td>↖</td></tr> <tr><td>3:</td><td>10.2</td><td>←</td></tr> <tr><td>4:</td><td>10.0</td><td>↑</td></tr> <tr><td>5:</td><td>10.5</td><td>←</td></tr> <tr><td>6:</td><td>10.2</td><td>←</td></tr> <tr><td>7:</td><td>10.4</td><td>→</td></tr> <tr><td>8:</td><td>10.5</td><td>↙</td></tr> </table>			1:	10.8x	→	2:	10.2	↖	3:	10.2	←	4:	10.0	↑	5:	10.5	←	6:	10.2	←	7:	10.4	→	8:	10.5	↙						
1:	10.8x	→																																
2:	10.2	↖																																
3:	10.2	←																																
4:	10.0	↑																																
5:	10.5	←																																
6:	10.2	←																																
7:	10.4	→																																
8:	10.5	↙																																
		<table border="0"> <tr><td>Serie</td><td colspan="3">80 (1x)</td></tr> <tr><td>Total</td><td colspan="3">0 (0x)</td></tr> </table>			Serie	80 (1x)			Total	0 (0x)																								
Serie	80 (1x)																																	
Total	0 (0x)																																	
20 Skud		<table border="0"> <tr><td>1:</td><td>10.4</td><td>↙</td></tr> <tr><td>2:</td><td>10.3</td><td>↗</td></tr> <tr><td>3:</td><td>10.8x</td><td>↗</td></tr> <tr><td>4:</td><td>10.5</td><td>→</td></tr> <tr><td>5:</td><td>10.4</td><td>→</td></tr> <tr><td>6:</td><td>10.3</td><td>↘</td></tr> <tr><td>7:</td><td>10.2</td><td>↗</td></tr> <tr><td>8:</td><td>10.5</td><td>↘</td></tr> <tr><td>9:</td><td>10.7x</td><td>↗</td></tr> <tr><td>10:</td><td>10.3</td><td>↖</td></tr> </table>			1:	10.4	↙	2:	10.3	↗	3:	10.8x	↗	4:	10.5	→	5:	10.4	→	6:	10.3	↘	7:	10.2	↗	8:	10.5	↘	9:	10.7x	↗	10:	10.3	↖
1:	10.4	↙																																
2:	10.3	↗																																
3:	10.8x	↗																																
4:	10.5	→																																
5:	10.4	→																																
6:	10.3	↘																																
7:	10.2	↗																																
8:	10.5	↘																																
9:	10.7x	↗																																
10:	10.3	↖																																
		<table border="0"> <tr><td>Serie</td><td colspan="3">100 (2x)</td></tr> <tr><td>Total</td><td colspan="3">100 (2x)</td></tr> </table>			Serie	100 (2x)			Total	100 (2x)																								
Serie	100 (2x)																																	
Total	100 (2x)																																	
20 Skud		<table border="0"> <tr><td>11:</td><td>10.0</td><td>↘</td></tr> <tr><td>12:</td><td>9.4</td><td>↘</td></tr> <tr><td>13:</td><td>10.6</td><td>↘</td></tr> <tr><td>14:</td><td>10.4</td><td>←</td></tr> <tr><td>15:</td><td>10.4</td><td>↘</td></tr> <tr><td>16:</td><td>10.3</td><td>↗</td></tr> <tr><td>17:</td><td>10.3</td><td>←</td></tr> <tr><td>18:</td><td>10.4</td><td>↘</td></tr> <tr><td>19:</td><td>10.6</td><td>↑</td></tr> <tr><td>20:</td><td>10.5</td><td>↘</td></tr> </table>			11:	10.0	↘	12:	9.4	↘	13:	10.6	↘	14:	10.4	←	15:	10.4	↘	16:	10.3	↗	17:	10.3	←	18:	10.4	↘	19:	10.6	↑	20:	10.5	↘
11:	10.0	↘																																
12:	9.4	↘																																
13:	10.6	↘																																
14:	10.4	←																																
15:	10.4	↘																																
16:	10.3	↗																																
17:	10.3	←																																
18:	10.4	↘																																
19:	10.6	↑																																
20:	10.5	↘																																
		<table border="0"> <tr><td>Serie</td><td colspan="3">99 (0x)</td></tr> <tr><td>Total</td><td colspan="3">199 (2x)</td></tr> </table>			Serie	99 (0x)			Total	199 (2x)																								
Serie	99 (0x)																																	
Total	199 (2x)																																	

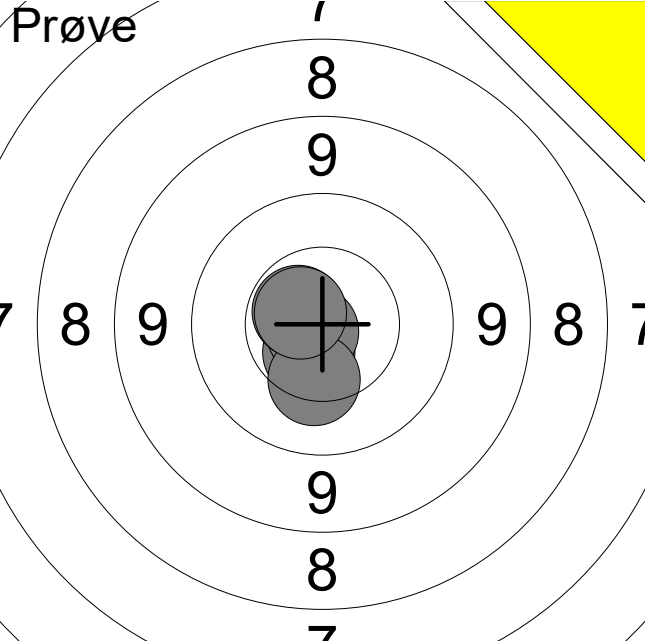
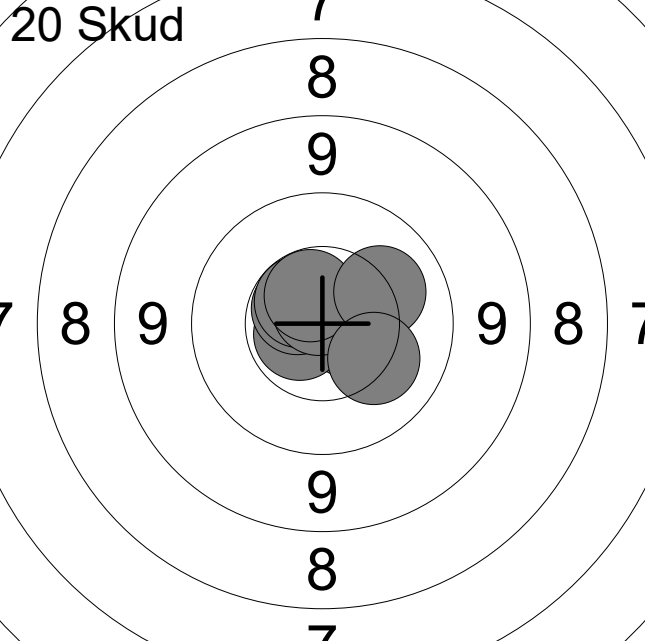
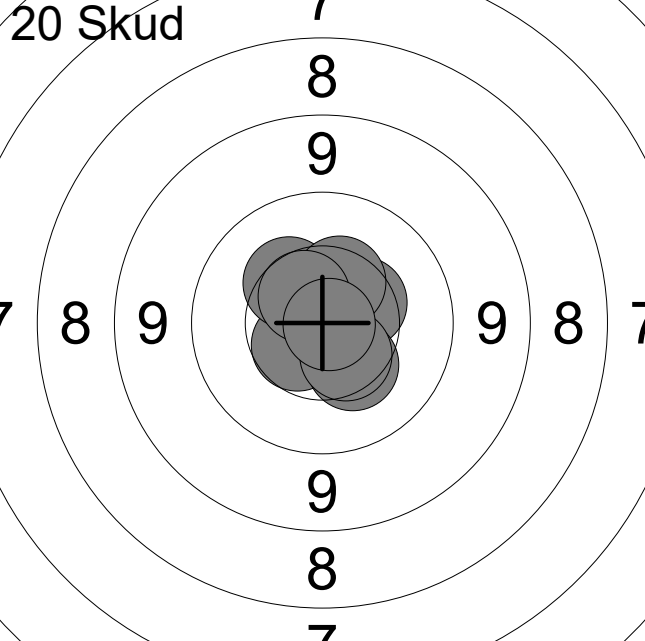
Hold 11	Skive 10	Sandra Youden																																
ØSF		Frederikssund Skytteforening, I		MÅ1																														
28.10.2024		Halloween Luftstævne 2024		Ølstykke skytteforening																														
Prøve		<table border="0"> <tr><td>1:</td><td>10.6</td><td>↘</td></tr> <tr><td>2:</td><td>10.8x</td><td>↙</td></tr> <tr><td>3:</td><td>10.3</td><td>↘</td></tr> <tr><td>4:</td><td>10.6x</td><td>↗</td></tr> <tr><td>5:</td><td>10.7x</td><td>↗</td></tr> </table>			1:	10.6	↘	2:	10.8x	↙	3:	10.3	↘	4:	10.6x	↗	5:	10.7x	↗															
1:	10.6	↘																																
2:	10.8x	↙																																
3:	10.3	↘																																
4:	10.6x	↗																																
5:	10.7x	↗																																
		<table border="0"> <tr><td>Serie</td><td colspan="2">50 (3x)</td></tr> <tr><td>Total</td><td colspan="2">0 (0x)</td></tr> </table>			Serie	50 (3x)		Total	0 (0x)																									
Serie	50 (3x)																																	
Total	0 (0x)																																	
20 Skud		<table border="0"> <tr><td>1:</td><td>10.6x</td><td>→</td></tr> <tr><td>2:</td><td>10.7x</td><td>↗</td></tr> <tr><td>3:</td><td>10.7x</td><td>↗</td></tr> <tr><td>4:</td><td>10.7x</td><td>↙</td></tr> <tr><td>5:</td><td>10.6x</td><td>↗</td></tr> <tr><td>6:</td><td>10.6x</td><td>↗</td></tr> <tr><td>7:</td><td>10.8x</td><td>↑</td></tr> <tr><td>8:</td><td>10.6x</td><td>↑</td></tr> <tr><td>9:</td><td>10.2</td><td>↗</td></tr> <tr><td>10:</td><td>10.2</td><td>↘</td></tr> </table>			1:	10.6x	→	2:	10.7x	↗	3:	10.7x	↗	4:	10.7x	↙	5:	10.6x	↗	6:	10.6x	↗	7:	10.8x	↑	8:	10.6x	↑	9:	10.2	↗	10:	10.2	↘
1:	10.6x	→																																
2:	10.7x	↗																																
3:	10.7x	↗																																
4:	10.7x	↙																																
5:	10.6x	↗																																
6:	10.6x	↗																																
7:	10.8x	↑																																
8:	10.6x	↑																																
9:	10.2	↗																																
10:	10.2	↘																																
		<table border="0"> <tr><td>Serie</td><td colspan="2">100 (8x)</td></tr> <tr><td>Total</td><td colspan="2">100 (8x)</td></tr> </table>			Serie	100 (8x)		Total	100 (8x)																									
Serie	100 (8x)																																	
Total	100 (8x)																																	
20 Skud		<table border="0"> <tr><td>11:</td><td>10.9x</td><td>↘</td></tr> <tr><td>12:</td><td>10.6</td><td>↙</td></tr> <tr><td>13:</td><td>10.3</td><td>↗</td></tr> <tr><td>14:</td><td>10.6x</td><td>↗</td></tr> <tr><td>15:</td><td>10.4</td><td>↗</td></tr> <tr><td>16:</td><td>10.3</td><td>↘</td></tr> <tr><td>17:</td><td>10.5</td><td>↘</td></tr> <tr><td>18:</td><td>10.4</td><td>↗</td></tr> <tr><td>19:</td><td>10.6</td><td>↗</td></tr> <tr><td>20:</td><td>10.9x</td><td>→</td></tr> </table>			11:	10.9x	↘	12:	10.6	↙	13:	10.3	↗	14:	10.6x	↗	15:	10.4	↗	16:	10.3	↘	17:	10.5	↘	18:	10.4	↗	19:	10.6	↗	20:	10.9x	→
11:	10.9x	↘																																
12:	10.6	↙																																
13:	10.3	↗																																
14:	10.6x	↗																																
15:	10.4	↗																																
16:	10.3	↘																																
17:	10.5	↘																																
18:	10.4	↗																																
19:	10.6	↗																																
20:	10.9x	→																																
		<table border="0"> <tr><td>Serie</td><td colspan="2">100 (3x)</td></tr> <tr><td>Total</td><td colspan="2">200 (11x)</td></tr> </table>			Serie	100 (3x)		Total	200 (11x)																									
Serie	100 (3x)																																	
Total	200 (11x)																																	

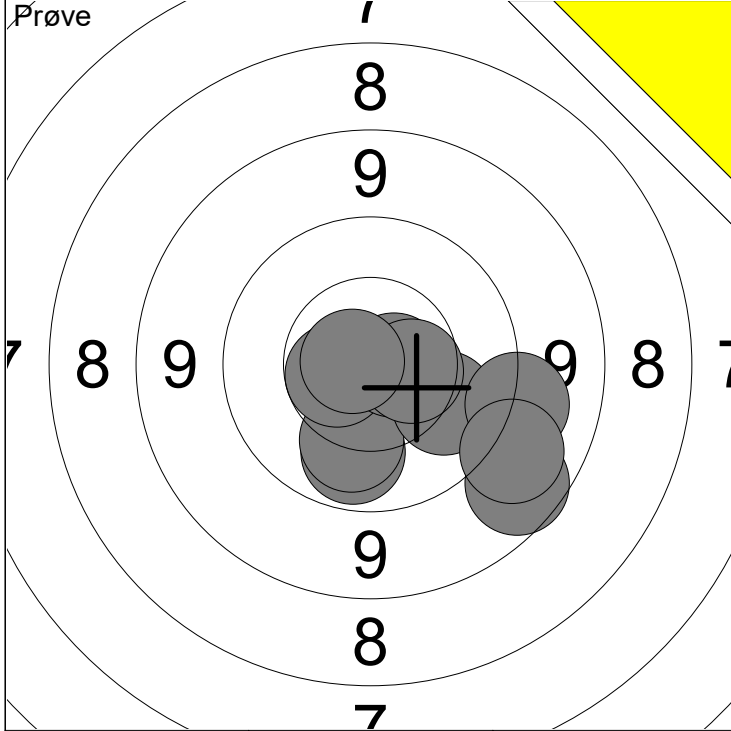

1: 10.0 ↓	6: 9.3 →	Serie	96 (2x)
2: 8.9 ↘	7: 10.7x →		
3: 10.1 ↓	8: 9.1 ↘	Total	0 (0x)
4: 10.6 ←	9: 10.5 →		
5: 10.1 ↘	10: 10.8x ←		

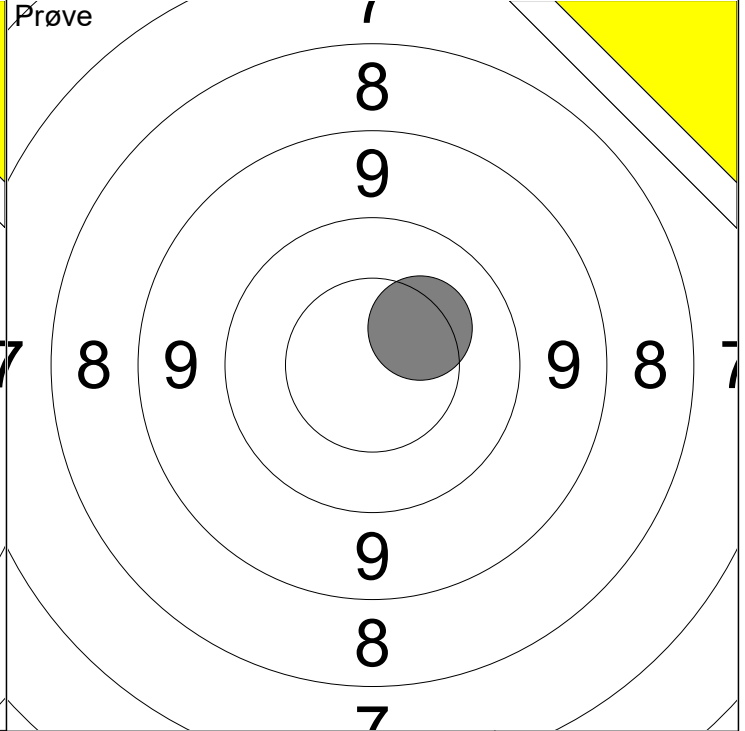

11: 10.3 ↗	Serie	10 (0x)
	Total	0 (0x)

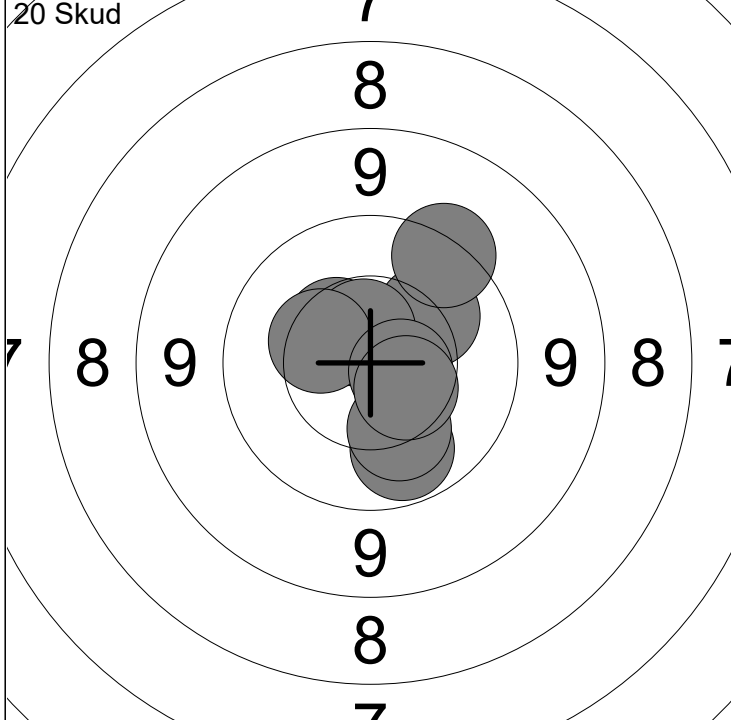

1: 10.6 ↗	6: 10.6x ↑	Serie	99 (2x)
2: 10.2 ↗	7: 10.4 ←		
3: 10.0 ↓	8: 10.6x →	Total	99 (2x)
4: 10.2 ↓	9: 9.6 ↗		
5: 10.5 ↗	10: 10.5 ↘		

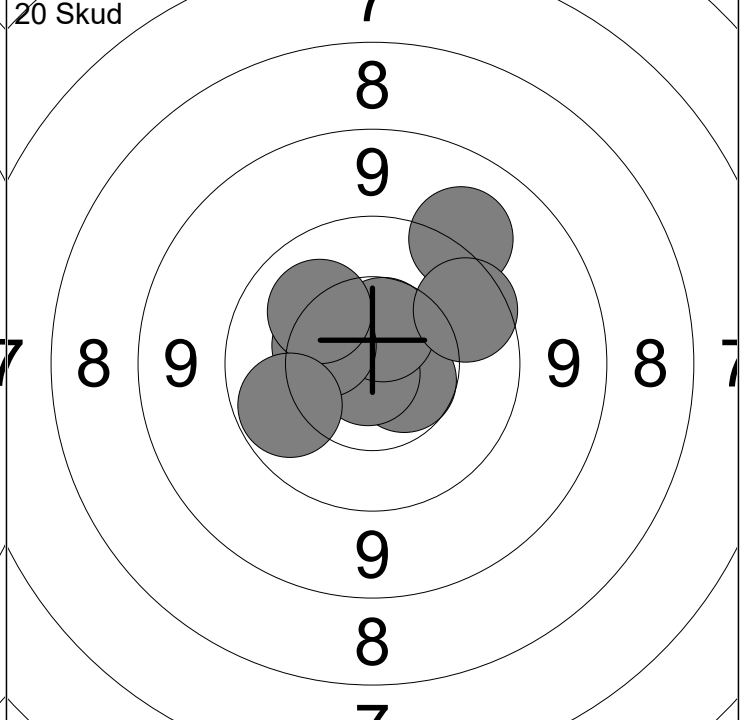

11: 10.7x ↑	16: 10.6 ↑	Serie	98 (3x)
12: 10.6 ↘	17: 10.4 ←		
13: 9.3 ↗	18: 9.8 ↗	Total	197 (5x)
14: 10.8x ←	19: 10.2 ↘		
15: 10.8x ↓	20: 10.0 ←		

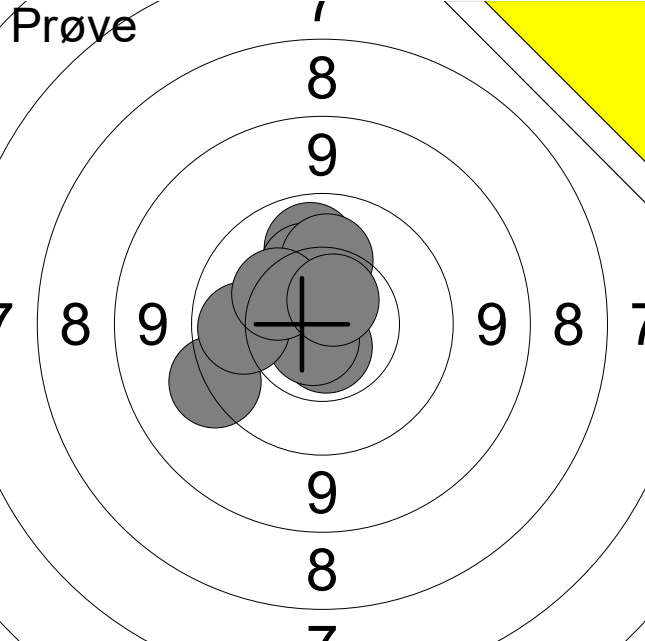
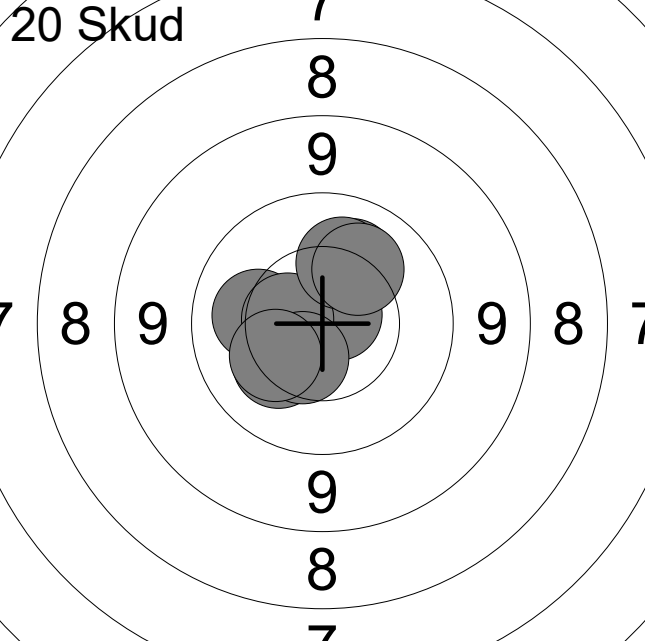
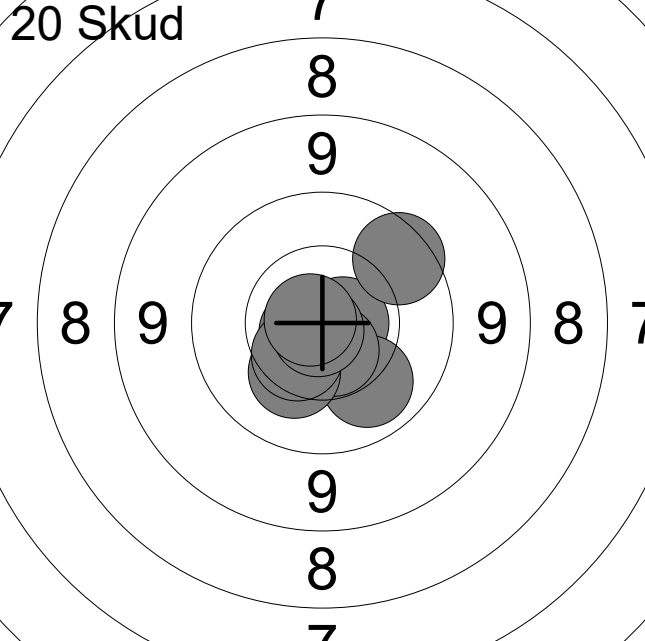
Hold 12	Skive 3	Carl-Emil Asmussen																																
ØSF		Frederikssund Skytteforening, I		J1																														
28.10.2024		Halloween Luftstævne 2024		Ølstykke skytteforening																														
Prøve		<table border="0"> <tr><td>1:</td><td>10.7x</td><td>↓</td></tr> <tr><td>2:</td><td>10.0</td><td>↑</td></tr> <tr><td>3:</td><td>9.5</td><td>←</td></tr> <tr><td>4:</td><td>10.3</td><td>↑</td></tr> <tr><td>5:</td><td>10.2</td><td>↑</td></tr> <tr><td>6:</td><td>10.7x</td><td>↓</td></tr> <tr><td>7:</td><td>10.0</td><td>←</td></tr> <tr><td>8:</td><td>10.3</td><td>↖</td></tr> <tr><td>9:</td><td>10.6x</td><td>↑</td></tr> </table>			1:	10.7x	↓	2:	10.0	↑	3:	9.5	←	4:	10.3	↑	5:	10.2	↑	6:	10.7x	↓	7:	10.0	←	8:	10.3	↖	9:	10.6x	↑			
1:	10.7x	↓																																
2:	10.0	↑																																
3:	9.5	←																																
4:	10.3	↑																																
5:	10.2	↑																																
6:	10.7x	↓																																
7:	10.0	←																																
8:	10.3	↖																																
9:	10.6x	↑																																
		Serie 89 (3x)																																
		Total 0 (0x)																																
20 Skud		<table border="0"> <tr><td>1:</td><td>10.3</td><td>↙</td></tr> <tr><td>2:</td><td>10.2</td><td>↑</td></tr> <tr><td>3:</td><td>10.2</td><td>←</td></tr> <tr><td>4:</td><td>10.5</td><td>←</td></tr> <tr><td>5:</td><td>10.8x</td><td>↗</td></tr> <tr><td>6:</td><td>10.5</td><td>←</td></tr> <tr><td>7:</td><td>10.5</td><td>↓</td></tr> <tr><td>8:</td><td>10.3</td><td>↙</td></tr> <tr><td>9:</td><td>10.2</td><td>↑</td></tr> <tr><td>10:</td><td>10.2</td><td>↗</td></tr> </table>			1:	10.3	↙	2:	10.2	↑	3:	10.2	←	4:	10.5	←	5:	10.8x	↗	6:	10.5	←	7:	10.5	↓	8:	10.3	↙	9:	10.2	↑	10:	10.2	↗
1:	10.3	↙																																
2:	10.2	↑																																
3:	10.2	←																																
4:	10.5	←																																
5:	10.8x	↗																																
6:	10.5	←																																
7:	10.5	↓																																
8:	10.3	↙																																
9:	10.2	↑																																
10:	10.2	↗																																
		Serie 100 (1x)																																
		Total 100 (1x)																																
20 Skud		<table border="0"> <tr><td>11:</td><td>10.7x</td><td>→</td></tr> <tr><td>12:</td><td>10.1</td><td>↘</td></tr> <tr><td>13:</td><td>10.8x</td><td>↙</td></tr> <tr><td>14:</td><td>10.6x</td><td>↓</td></tr> <tr><td>15:</td><td>10.3</td><td>↓</td></tr> <tr><td>16:</td><td>10.7x</td><td>←</td></tr> <tr><td>17:</td><td>10.5</td><td>↓</td></tr> <tr><td>18:</td><td>10.8x</td><td>↓</td></tr> <tr><td>19:</td><td>10.8x</td><td>←</td></tr> <tr><td>20:</td><td>9.8</td><td>↗</td></tr> </table>			11:	10.7x	→	12:	10.1	↘	13:	10.8x	↙	14:	10.6x	↓	15:	10.3	↓	16:	10.7x	←	17:	10.5	↓	18:	10.8x	↓	19:	10.8x	←	20:	9.8	↗
11:	10.7x	→																																
12:	10.1	↘																																
13:	10.8x	↙																																
14:	10.6x	↓																																
15:	10.3	↓																																
16:	10.7x	←																																
17:	10.5	↓																																
18:	10.8x	↓																																
19:	10.8x	←																																
20:	9.8	↗																																
		Serie 99 (6x)																																
		Total 199 (7x)																																

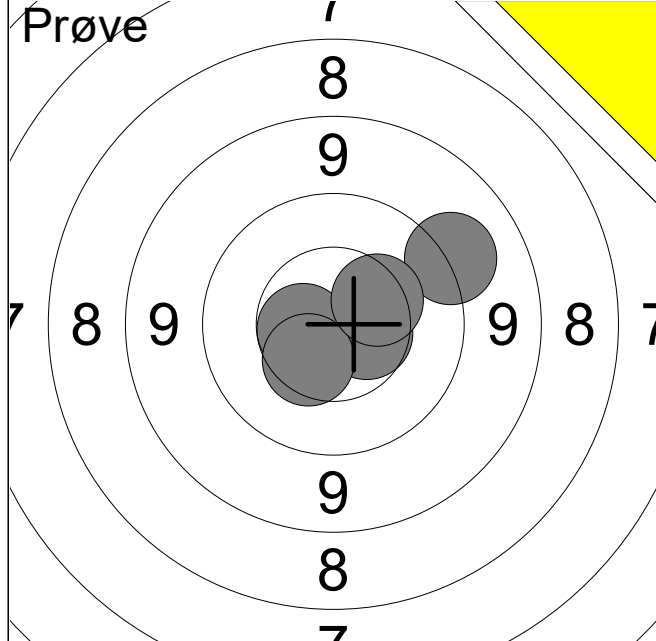

1:	10.5	→
2:	9.3	↗
3:	10.6	←
4:	10.4	↘
5:	10.4	↗
Serie		49 (0x)
Total		0 (0x)

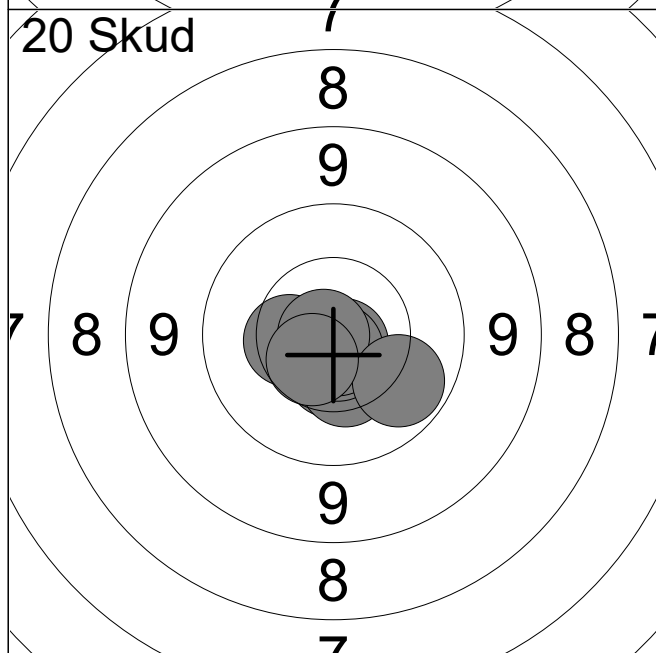

1:	10.4	←
2:	10.6x	↓
3:	10.5	↓
4:	10.8x	↘
5:	10.4	↘
6:	10.7x	↓
7:	10.8x	↓
8:	10.8x	←
9:	10.0	↘
10:	10.6	↘
Serie		100 (5x)
Total		100 (5x)

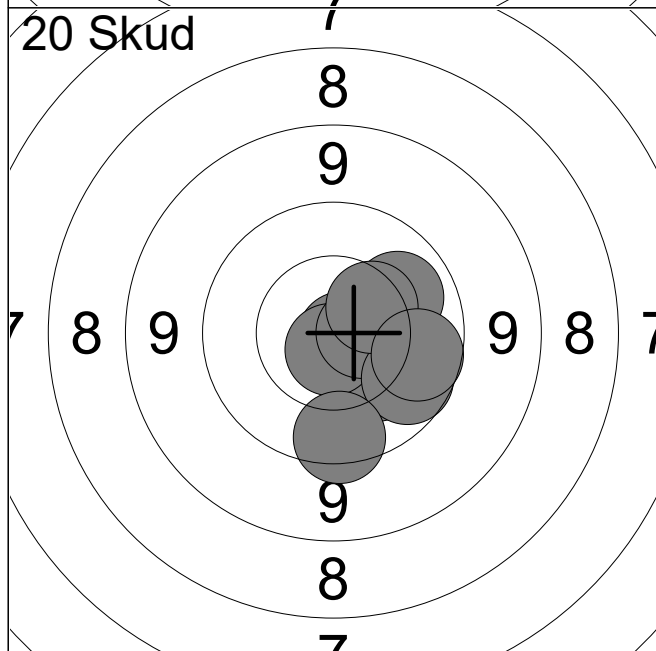

11:	10.2	↘
12:	10.4	↘
13:	10.8x	↘
14:	10.7x	↓
15:	10.6x	→
16:	9.9	↘
17:	10.1	↗
18:	9.7	↓
19:	10.4	↗
20:	9.9	→
Serie		97 (3x)
Total		197 (8x)

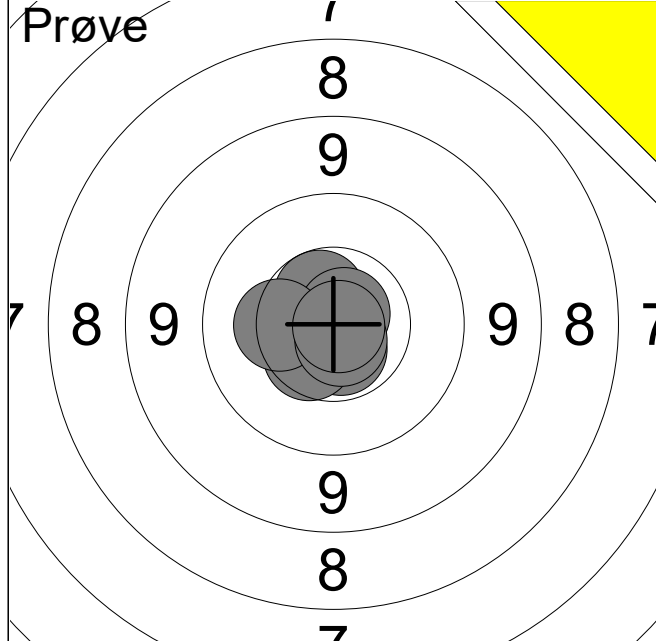

1:	10.6	↗
2:	10.6x	↘
3:	10.5	↘
4:	10.8x	↗
5:	10.3	←
6:	10.7x	↘
7:	10.9x	→
Serie		70 (4x)
Total		0 (0x)

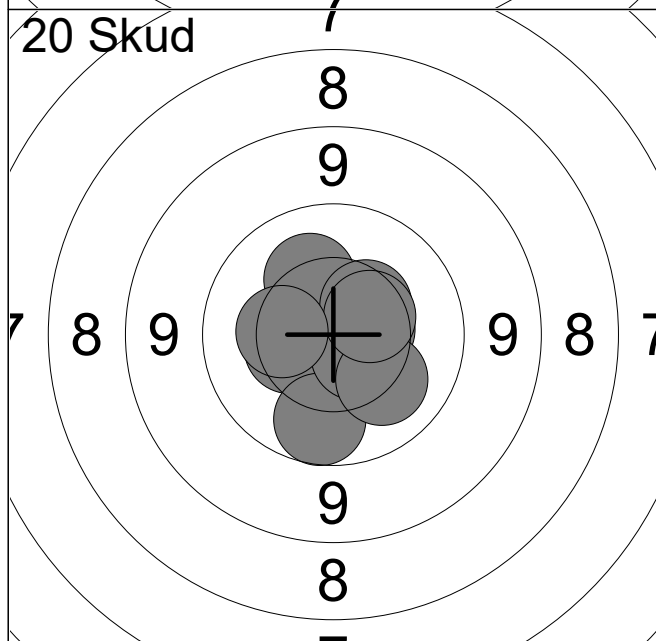

1:	10.9x	→
2:	10.4	←
3:	9.9	↘
4:	10.5	→
5:	10.6x	↘
6:	10.2	↘
7:	10.2	↗
8:	10.4	↗
9:	10.5	↗
10:	10.3	←
Serie		99 (2x)
Total		99 (2x)

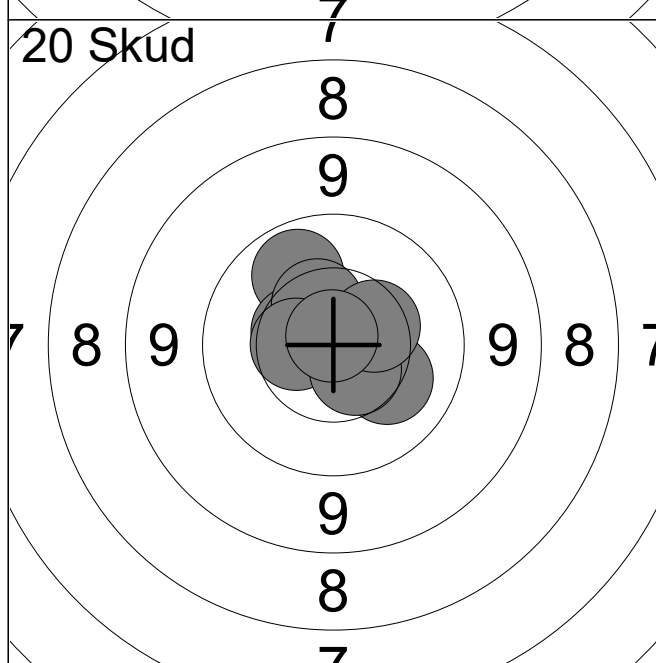

11:	10.0	↗
12:	10.5	←
13:	10.4	↗
14:	10.8x	←
15:	10.5	←
16:	10.2	↘
17:	10.7x	→
18:	10.6	↘
19:	10.4	↗
20:	10.8x	↗
Serie		100 (3x)
Total		199 (5x)

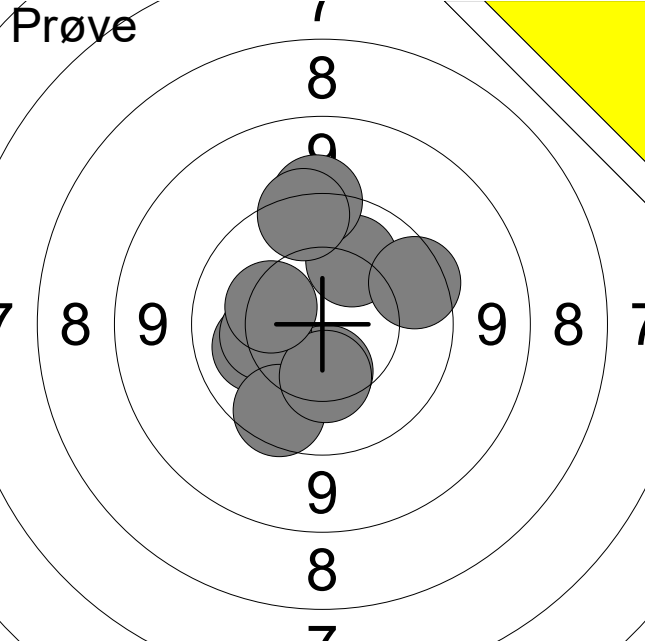
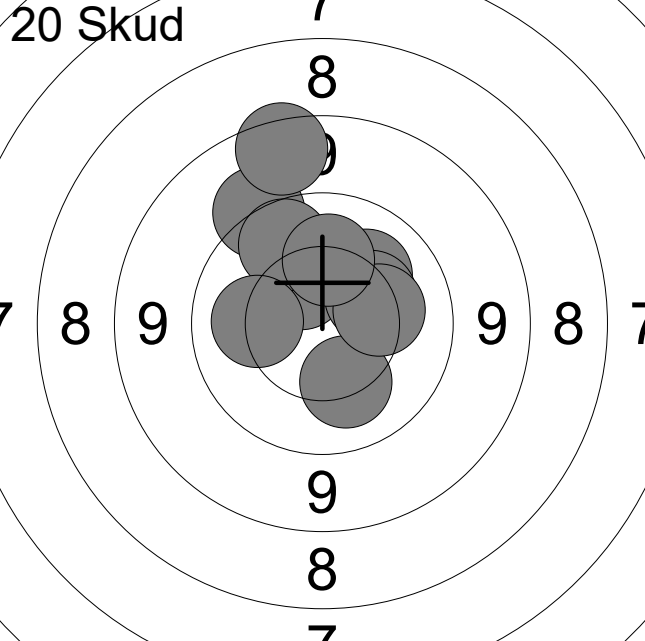
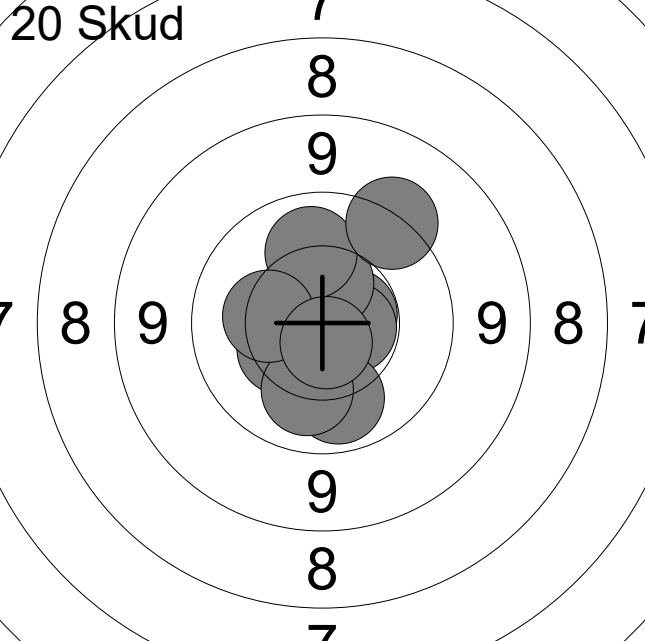
Hold 12	Skive 8	Anne Illum Andersen																																
ØSF		Frederikssund Skytteforening, I		MÅ2																														
28.10.2024		Halloween Luftstævne 2024		Ølstykke skytteforening																														
Prøve		<table border="0"> <tr><td>1:</td><td>10.4</td><td>↓</td></tr> <tr><td>2:</td><td>10.1</td><td>↑</td></tr> <tr><td>3:</td><td>10.1</td><td>←</td></tr> <tr><td>4:</td><td>10.3</td><td>←</td></tr> <tr><td>5:</td><td>9.7</td><td>→</td></tr> <tr><td>6:</td><td>9.8</td><td>↓</td></tr> <tr><td>7:</td><td>9.4</td><td>↑</td></tr> <tr><td>8:</td><td>9.6</td><td>↑</td></tr> <tr><td>9:</td><td>10.3</td><td>↓</td></tr> <tr><td>10:</td><td>10.3</td><td>←</td></tr> </table>			1:	10.4	↓	2:	10.1	↑	3:	10.1	←	4:	10.3	←	5:	9.7	→	6:	9.8	↓	7:	9.4	↑	8:	9.6	↑	9:	10.3	↓	10:	10.3	←
1:	10.4	↓																																
2:	10.1	↑																																
3:	10.1	←																																
4:	10.3	←																																
5:	9.7	→																																
6:	9.8	↓																																
7:	9.4	↑																																
8:	9.6	↑																																
9:	10.3	↓																																
10:	10.3	←																																
		Serie 96 (0x)																																
		Total 0 (0x)																																
20 Skud		<table border="0"> <tr><td>1:</td><td>9.4</td><td>↑</td></tr> <tr><td>2:</td><td>10.2</td><td>↑</td></tr> <tr><td>3:</td><td>10.4</td><td>↑</td></tr> <tr><td>4:</td><td>10.2</td><td>↓</td></tr> <tr><td>5:</td><td>9.9</td><td>↑</td></tr> <tr><td>6:</td><td>10.2</td><td>←</td></tr> <tr><td>7:</td><td>10.3</td><td>→</td></tr> <tr><td>8:</td><td>10.3</td><td>→</td></tr> <tr><td>9:</td><td>8.7</td><td>↑</td></tr> <tr><td>10:</td><td>10.2</td><td>↑</td></tr> </table>			1:	9.4	↑	2:	10.2	↑	3:	10.4	↑	4:	10.2	↓	5:	9.9	↑	6:	10.2	←	7:	10.3	→	8:	10.3	→	9:	8.7	↑	10:	10.2	↑
1:	9.4	↑																																
2:	10.2	↑																																
3:	10.4	↑																																
4:	10.2	↓																																
5:	9.9	↑																																
6:	10.2	←																																
7:	10.3	→																																
8:	10.3	→																																
9:	8.7	↑																																
10:	10.2	↑																																
		Serie 96 (0x)																																
		Total 96 (0x)																																
20 Skud		<table border="0"> <tr><td>11:</td><td>10.6x</td><td>→</td></tr> <tr><td>12:</td><td>10.6x</td><td>→</td></tr> <tr><td>13:</td><td>10.5</td><td>↑</td></tr> <tr><td>14:</td><td>10.1</td><td>↑</td></tr> <tr><td>15:</td><td>9.5</td><td>↑</td></tr> <tr><td>16:</td><td>10.4</td><td>←</td></tr> <tr><td>17:</td><td>10.0</td><td>↓</td></tr> <tr><td>18:</td><td>10.1</td><td>↓</td></tr> <tr><td>19:</td><td>10.3</td><td>←</td></tr> <tr><td>20:</td><td>10.7x</td><td>↓</td></tr> </table>			11:	10.6x	→	12:	10.6x	→	13:	10.5	↑	14:	10.1	↑	15:	9.5	↑	16:	10.4	←	17:	10.0	↓	18:	10.1	↓	19:	10.3	←	20:	10.7x	↓
11:	10.6x	→																																
12:	10.6x	→																																
13:	10.5	↑																																
14:	10.1	↑																																
15:	9.5	↑																																
16:	10.4	←																																
17:	10.0	↓																																
18:	10.1	↓																																
19:	10.3	←																																
20:	10.7x	↓																																
		Serie 99 (3x)																																
		Total 195 (3x)																																

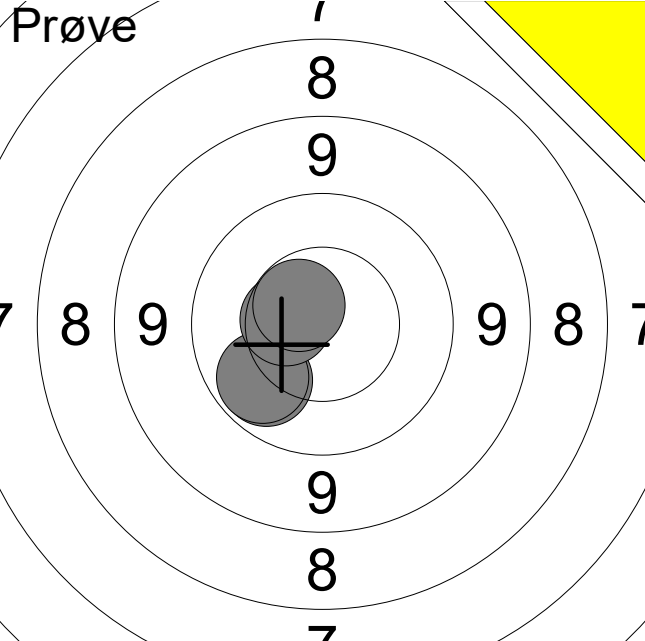
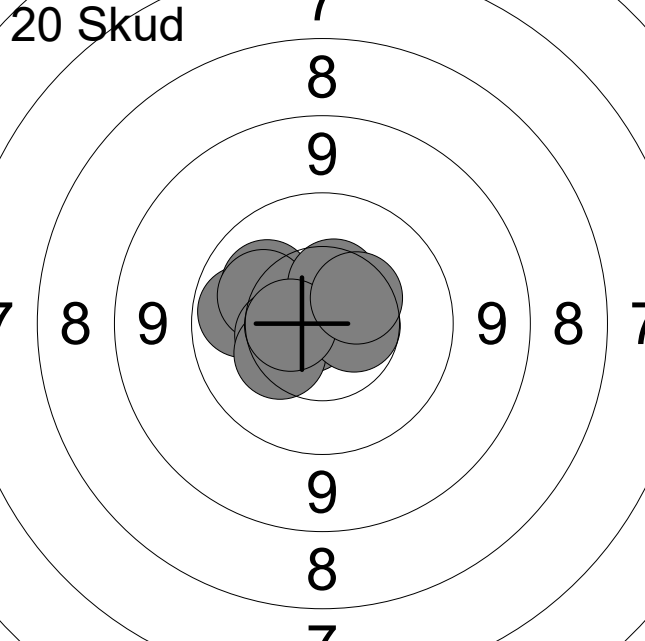
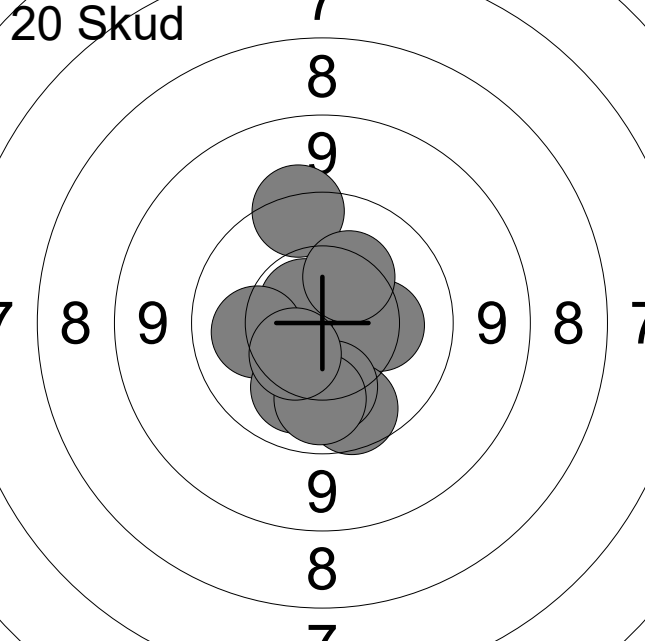
Hold 12	Skive 9	Kean Kofoed Noerskov																																
ØSF		Frederikssund Skytteforening, I		Å2																														
28.10.2024		Halloween Luftstævne 2024		Ølstykke skytteforening																														
Prøve		<table border="0"> <tr><td>1:</td><td>10.0</td><td>↙</td></tr> <tr><td>2:</td><td>10.0</td><td>↙</td></tr> <tr><td>3:</td><td>10.5</td><td>←</td></tr> <tr><td>4:</td><td>10.6x</td><td>↗</td></tr> </table>			1:	10.0	↙	2:	10.0	↙	3:	10.5	←	4:	10.6x	↗																		
1:	10.0	↙																																
2:	10.0	↙																																
3:	10.5	←																																
4:	10.6x	↗																																
		<table border="0"> <tr><td>Serie</td><td colspan="3">40 (1x)</td></tr> <tr><td>Total</td><td colspan="3">0 (0x)</td></tr> </table>			Serie	40 (1x)			Total	0 (0x)																								
Serie	40 (1x)																																	
Total	0 (0x)																																	
20 Skud		<table border="0"> <tr><td>1:</td><td>10.8x</td><td>←</td></tr> <tr><td>2:</td><td>10.0</td><td>←</td></tr> <tr><td>3:</td><td>10.2</td><td>↗</td></tr> <tr><td>4:</td><td>10.2</td><td>↖</td></tr> <tr><td>5:</td><td>10.4</td><td>←</td></tr> <tr><td>6:</td><td>10.3</td><td>↙</td></tr> <tr><td>7:</td><td>10.5</td><td>↗</td></tr> <tr><td>8:</td><td>10.6</td><td>→</td></tr> <tr><td>9:</td><td>10.6</td><td>←</td></tr> <tr><td>10:</td><td>10.4</td><td>↗</td></tr> </table>			1:	10.8x	←	2:	10.0	←	3:	10.2	↗	4:	10.2	↖	5:	10.4	←	6:	10.3	↙	7:	10.5	↗	8:	10.6	→	9:	10.6	←	10:	10.4	↗
1:	10.8x	←																																
2:	10.0	←																																
3:	10.2	↗																																
4:	10.2	↖																																
5:	10.4	←																																
6:	10.3	↙																																
7:	10.5	↗																																
8:	10.6	→																																
9:	10.6	←																																
10:	10.4	↗																																
		<table border="0"> <tr><td>Serie</td><td colspan="3">100 (1x)</td></tr> <tr><td>Total</td><td colspan="3">100 (1x)</td></tr> </table>			Serie	100 (1x)			Total	100 (1x)																								
Serie	100 (1x)																																	
Total	100 (1x)																																	
20 Skud		<table border="0"> <tr><td>11:</td><td>10.7x</td><td>↗</td></tr> <tr><td>12:</td><td>10.3</td><td>→</td></tr> <tr><td>13:</td><td>10.2</td><td>←</td></tr> <tr><td>14:</td><td>10.1</td><td>↙</td></tr> <tr><td>15:</td><td>9.9</td><td>↙</td></tr> <tr><td>16:</td><td>9.6</td><td>↗</td></tr> <tr><td>17:</td><td>10.2</td><td>↙</td></tr> <tr><td>18:</td><td>10.3</td><td>↗</td></tr> <tr><td>19:</td><td>10.1</td><td>↙</td></tr> <tr><td>20:</td><td>10.5</td><td>↙</td></tr> </table>			11:	10.7x	↗	12:	10.3	→	13:	10.2	←	14:	10.1	↙	15:	9.9	↙	16:	9.6	↗	17:	10.2	↙	18:	10.3	↗	19:	10.1	↙	20:	10.5	↙
11:	10.7x	↗																																
12:	10.3	→																																
13:	10.2	←																																
14:	10.1	↙																																
15:	9.9	↙																																
16:	9.6	↗																																
17:	10.2	↙																																
18:	10.3	↗																																
19:	10.1	↙																																
20:	10.5	↙																																
		<table border="0"> <tr><td>Serie</td><td colspan="3">98 (1x)</td></tr> <tr><td>Total</td><td colspan="3">198 (2x)</td></tr> </table>			Serie	98 (1x)			Total	198 (2x)																								
Serie	98 (1x)																																	
Total	198 (2x)																																	

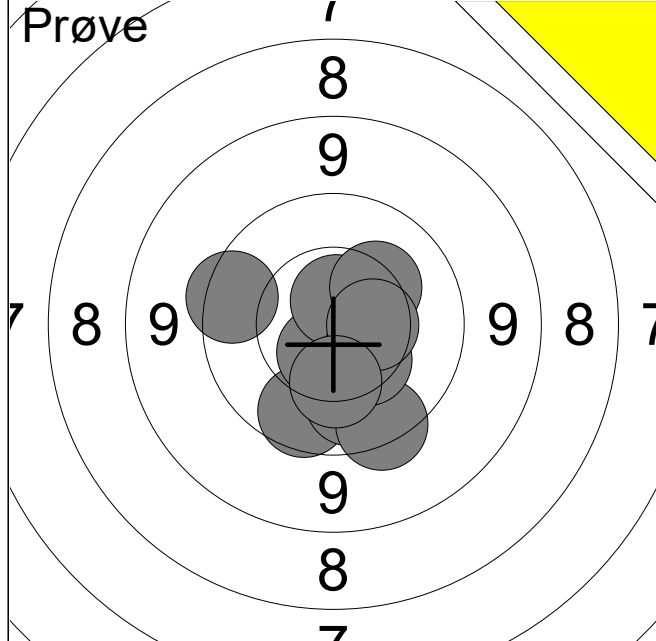

1:	9.9	↘
2:	10.0	↘
3:	9.6	↘
4:	10.6x	↘
5:	10.7x	↑
6:	10.3	↗
7:	10.4	↘
8:	9.7	←
9:	10.5	→
10:	10.3	↓
Serie		97 (2x)
Total		0 (0x)

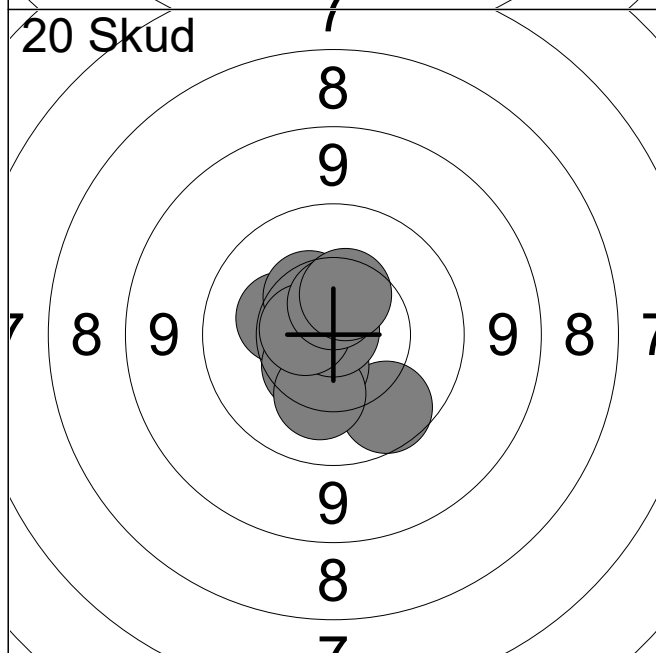

1:	9.9	↘
2:	10.6	↘
3:	10.3	←
4:	10.4	↗
5:	10.5	↘
6:	10.2	↘
7:	10.9x	↑
8:	10.6x	←
9:	10.6x	↑
10:	10.5	↗
Serie		99 (3x)
Total		99 (3x)

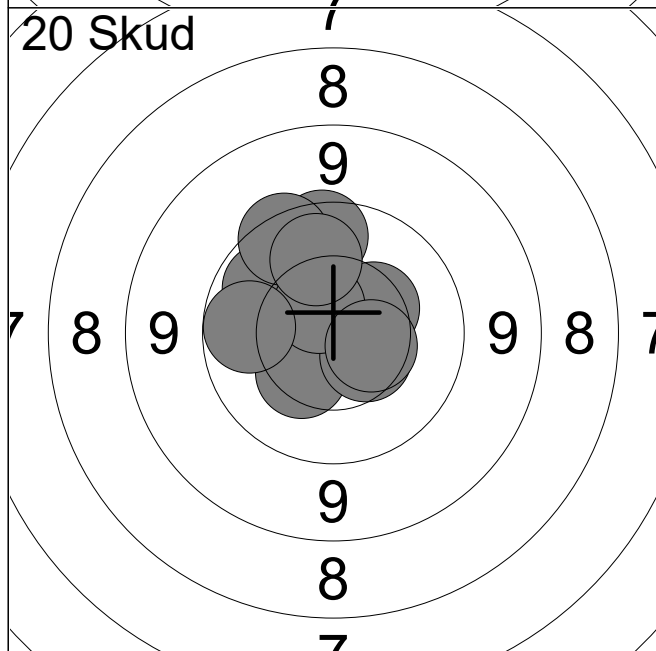

11:	10.4	↗
12:	9.8	↑
13:	10.4	↘
14:	10.5	↘
15:	10.0	↗
16:	9.7	↗
17:	10.6x	↗
18:	10.1	↑
19:	10.5	↘
20:	10.0	←
Serie		98 (1x)
Total		197 (4x)

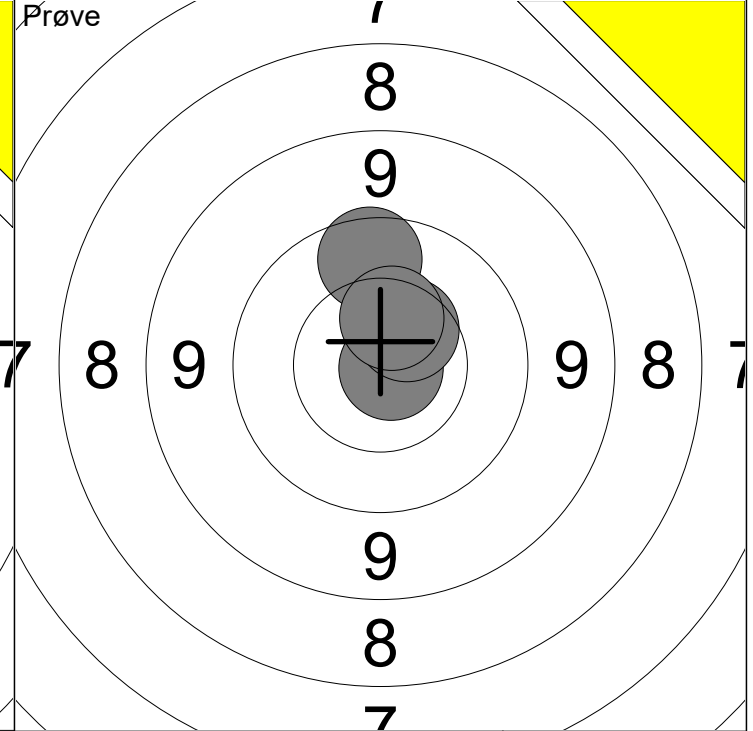
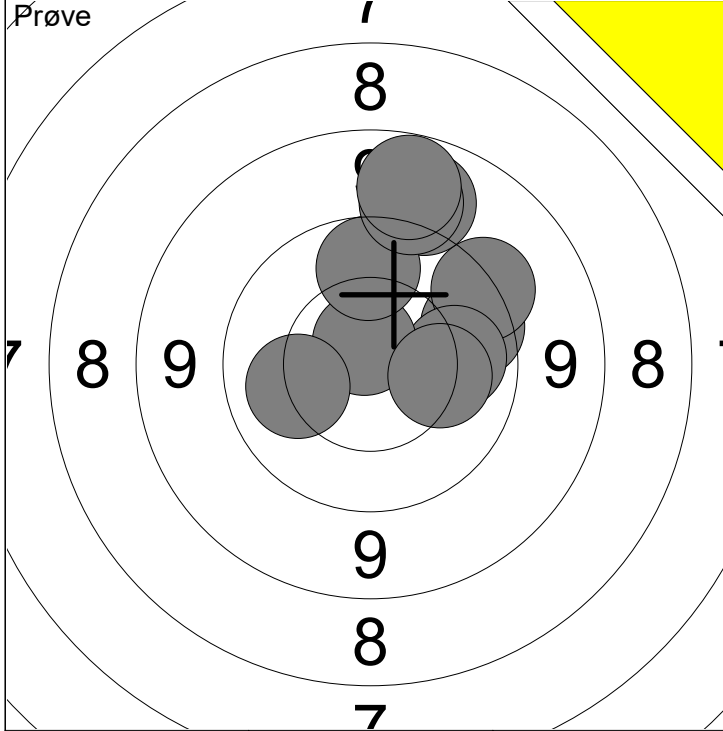

1: 9.8 →	6: 10.2 ←	Serie	94 (1x)
2: 9.5 ↗	7: 10.2 →		
3: 9.1 ↑	8: 9.9 ↑	Total	0 (0x)
4: 10.1 →	9: 9.1 ↑		
5: 10.7x ↑	10: 9.0 ↑		

11: 10.8x →	Serie	39 (1x)
12: 9.8 ↑		
13: 10.5 ↗	Total	0 (0x)
14: 10.4 ↑		

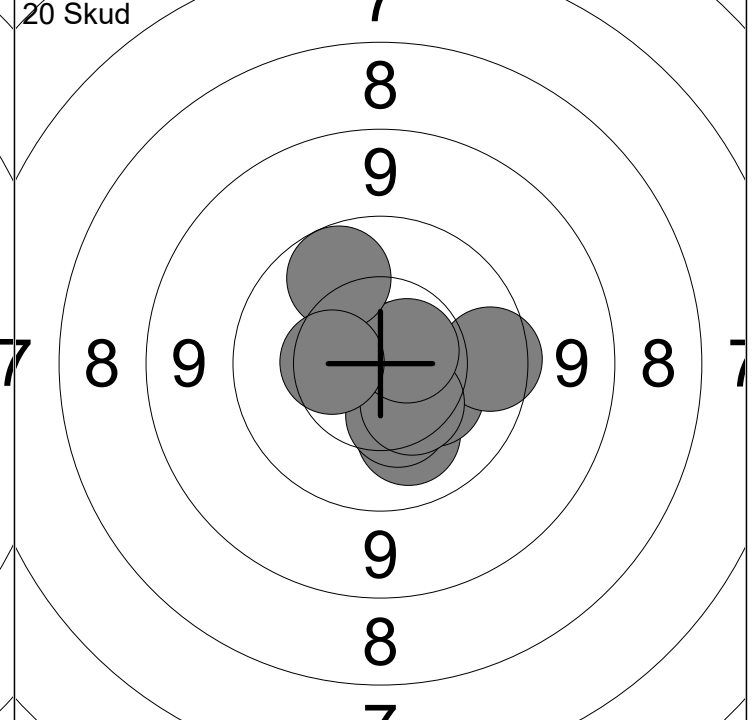
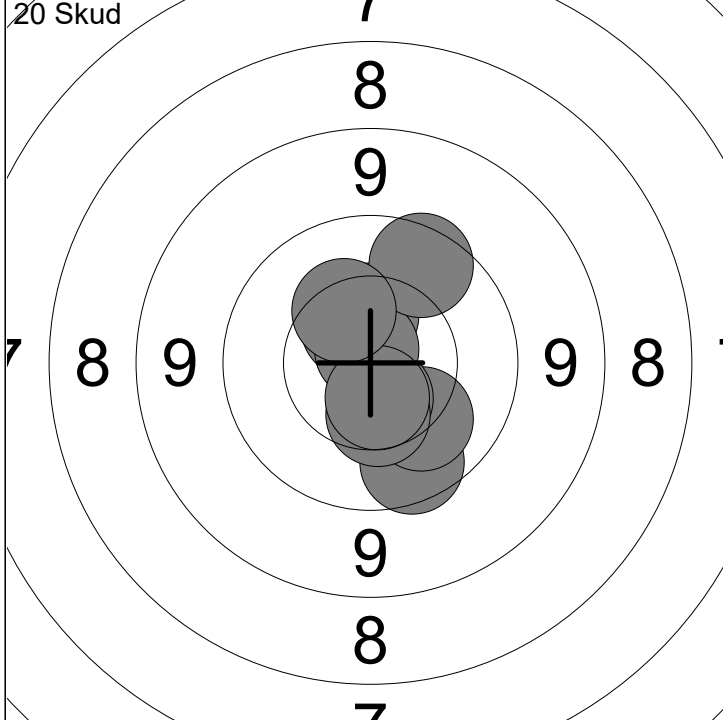

1: 10.5 ↑	6: 10.8x ↑	Serie	98 (1x)
2: 10.5 ↗	7: 9.8 ↗		
3: 9.8 ↓	8: 10.4 ↓	Total	98 (1x)
4: 10.2 ↓	9: 10.6 ↓		
5: 10.6 ↓	10: 10.3 ↗		

11: 10.2 ↓	Serie	99 (2x)
12: 10.7x ↗		
13: 10.6 ↗	Total	197 (3x)
14: 10.4 ↓		
15: 10.3 ↘	16: 9.8 →	
	17: 10.4 ↓	
	18: 10.6x ↗	
	19: 10.0 ↑	
	20: 10.4 ←	

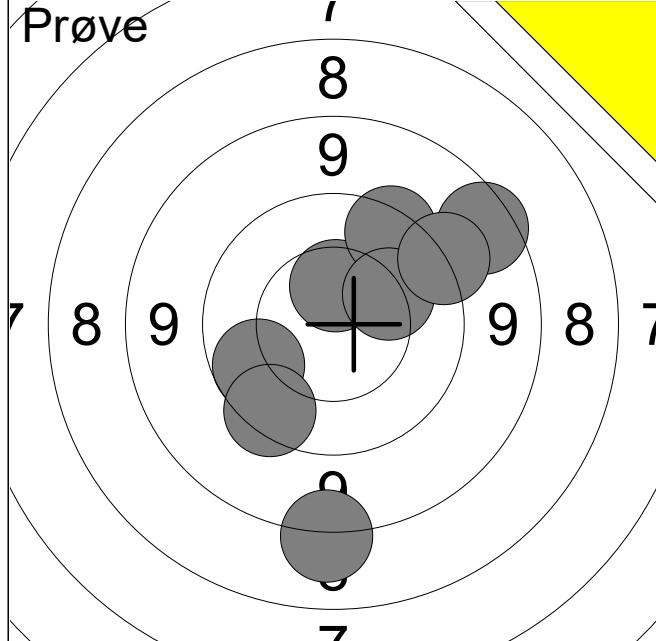

1:	10.5	↑
2:	8.3	↓
3:	9.9	←
4:	9.7	↙
5:	8.8	↗
6:	9.6	↖
7:	10.2	↗
8:	9.4	↗
Serie		72 (0x)
Total		0 (0x)

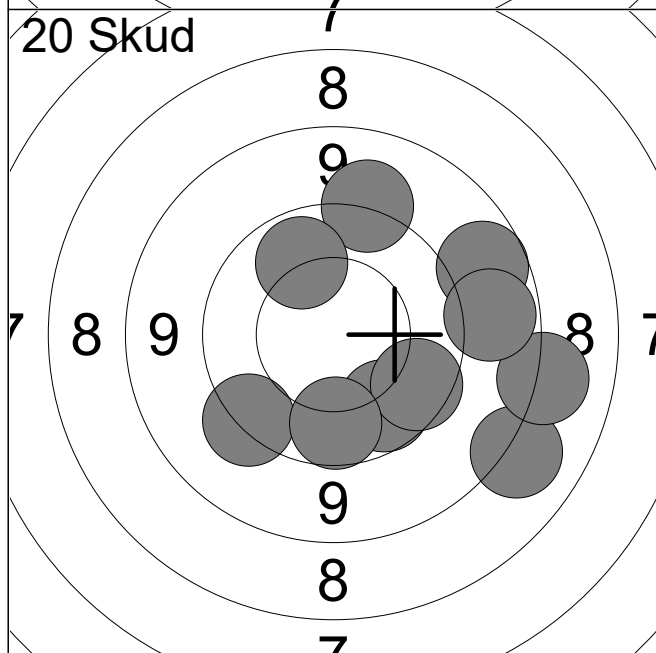

1:	8.2	↘
2:	9.5	↙
3:	9.9	↘
4:	9.3	↖
5:	8.3	→
6:	9.8	↘
7:	8.9	↗
8:	9.0	→
9:	10.0	↖
10:	9.9	↓
Serie		88 (0x)
Total		88 (0x)

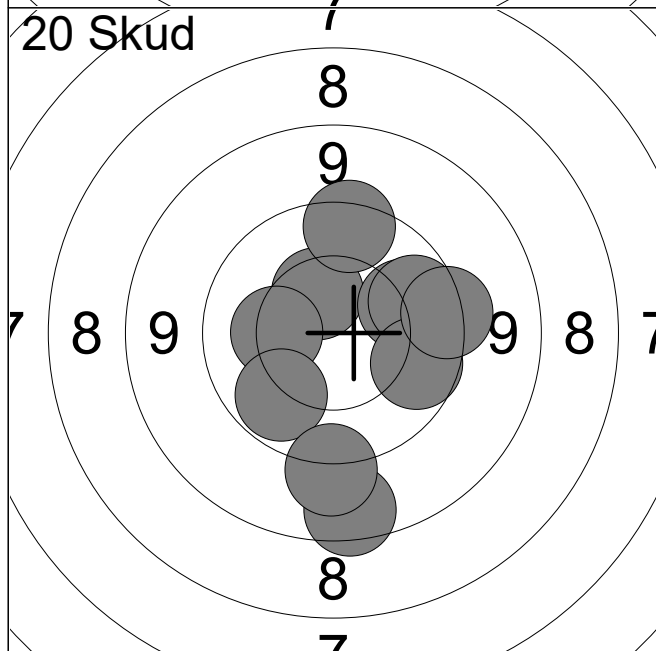

11:	10.5	↖
12:	8.7	↓
13:	10.3	←
14:	10.0	↙
15:	9.3	↓
16:	9.7	↖
17:	10.1	↗
18:	9.9	↗
19:	9.9	→
20:	9.6	→
Serie		93 (0x)
Total		181 (0x)

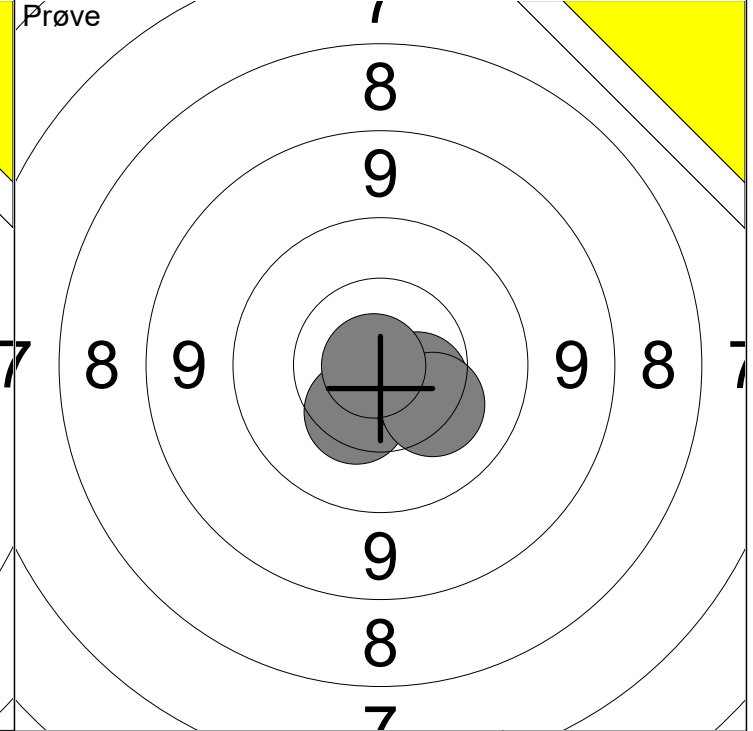
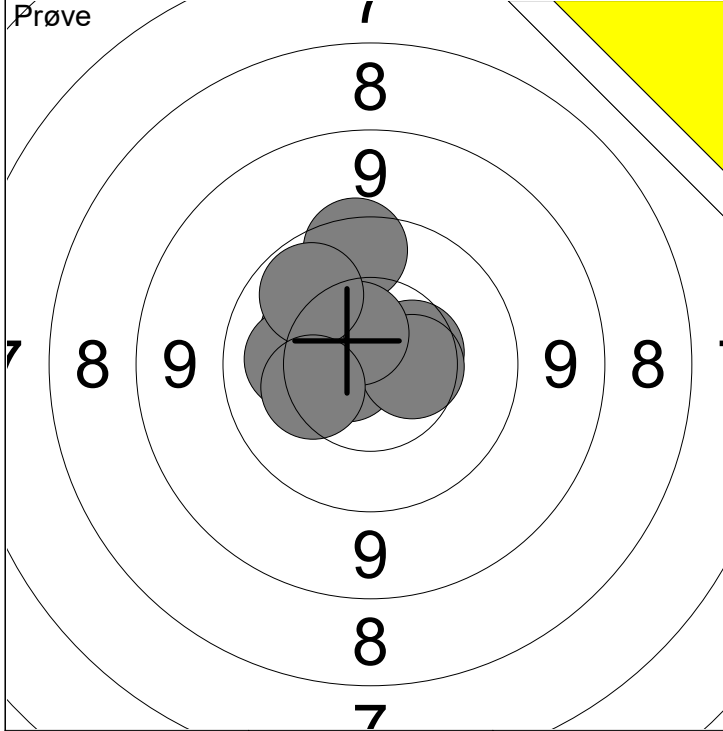

1: 10.5 →	6: 10.5 →	Serie	99 (2x)
2: 10.7x ←	7: 10.6x ↗		
3: 10.3 ↖	8: 10.2 ←	Total	0 (0x)
4: 10.3 ←	9: 10.0 ↗		
5: 9.7 ↑	10: 10.3 ←		

11: 10.4 ↓	Serie	40 (1x)
12: 10.5 →		
13: 10.3 ↓	Total	0 (0x)
14: 10.9x ←		

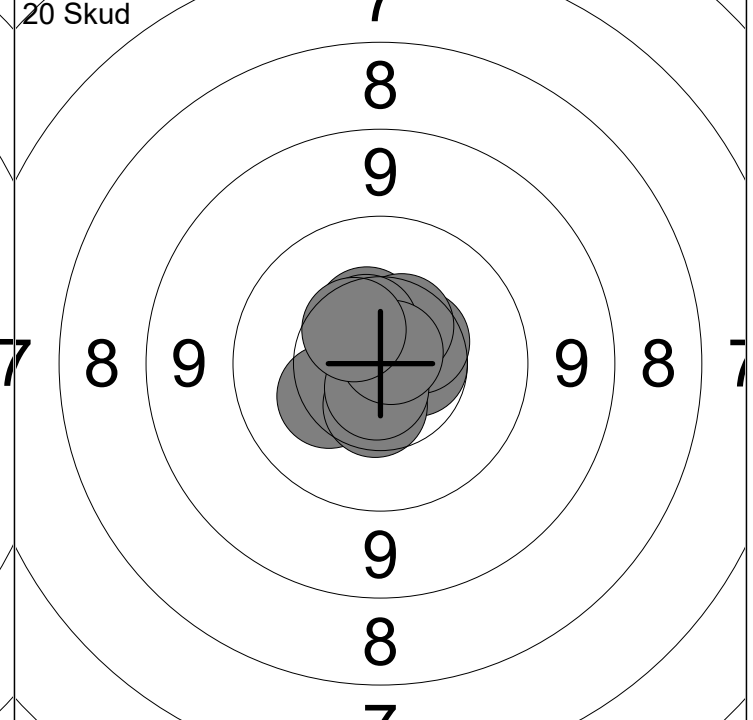
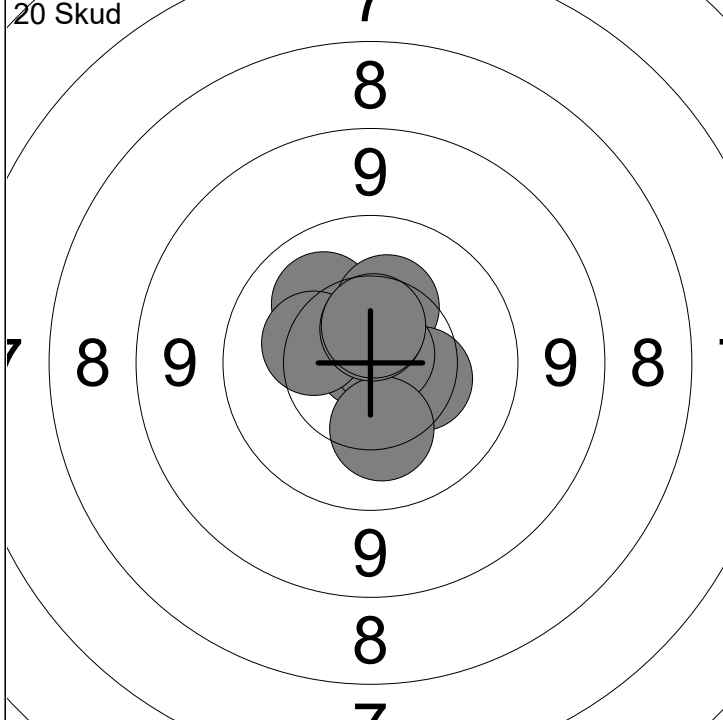

1: 10.2 ↖	6: 10.8x ↗	Serie	100 (4x)
2: 10.8x →	7: 10.3 ←		
3: 10.3 ↑	8: 10.2 ↓	Total	100 (4x)
4: 10.9x ↖	9: 10.6x ↑		
5: 10.4 →	10: 10.6 ↑		

11: 10.3 ←	Serie	100 (3x)
12: 10.6x →		
13: 10.5 ↗	Total	200 (7x)
14: 10.5 ↑		
15: 10.5 ↓		

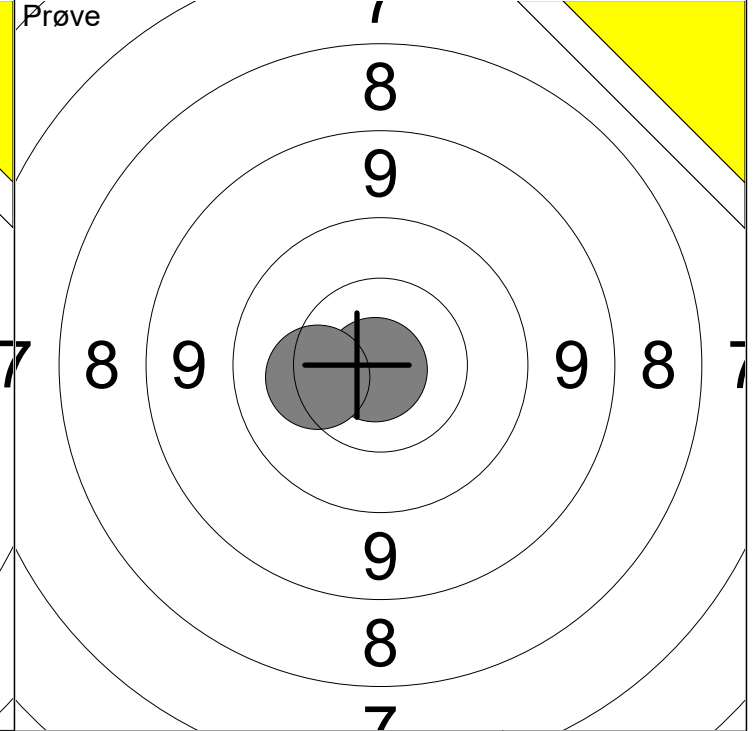
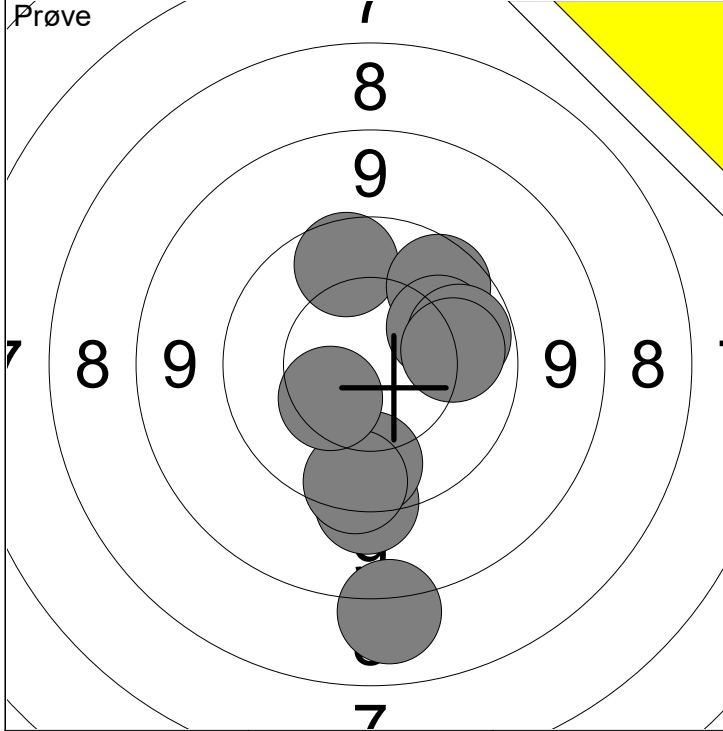

1: 8.2 ↓	6: 9.9 ↑	Serie 93 (0x)
2: 9.5 ↓	7: 9.9 ↗	
3: 9.9 ↓	8: 10.1 ↗	Total 0 (0x)
4: 9.7 ↓	9: 10.0 →	
5: 10.4 ↙	10: 10.1 →	

11: 10.9x ↙	Serie 20 (1x)
12: 10.3 ←	
Total 0 (0x)	

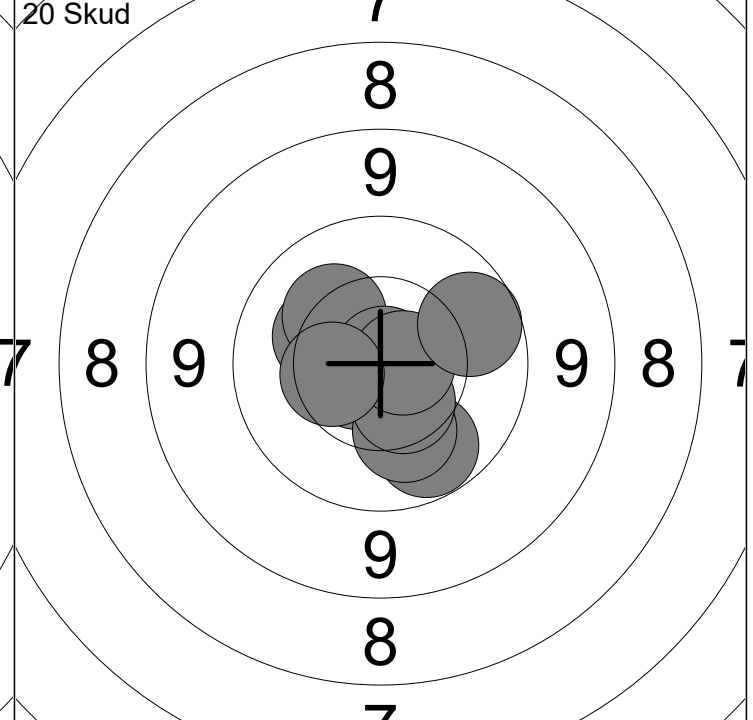
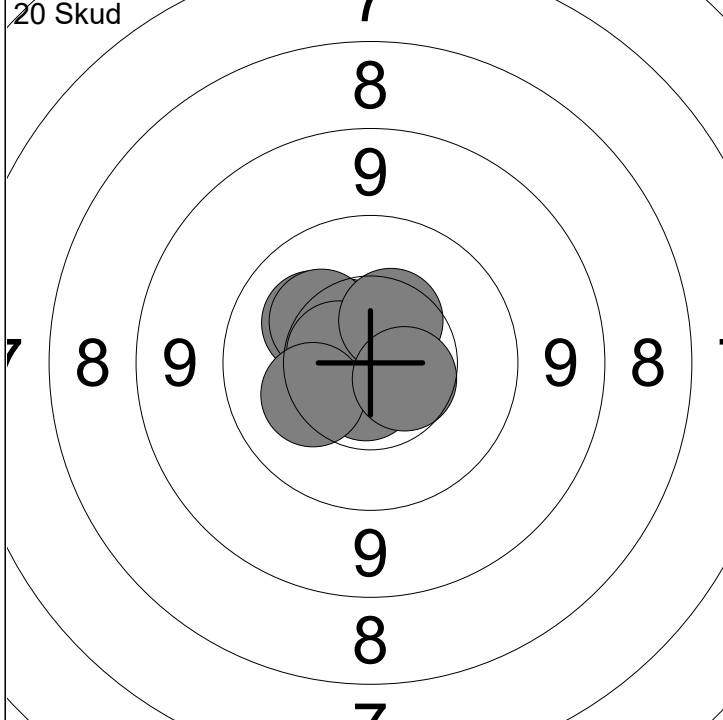

1: 10.7x ↗	6: 10.3 ↙	Serie 100 (3x)
2: 10.5 ↗	7: 10.6x ←	
3: 10.6 ←	8: 10.5 ↗	Total 100 (3x)
4: 10.7x ↓	9: 10.3 ←	
5: 10.2 ↙	10: 10.6 ↘	

11: 10.0 ↓	16: 10.2 ↓	Serie 99 (3x)
12: 10.3 ←	17: 10.5 ↓	
13: 10.7x ↙	18: 10.7x →	Total 199 (6x)
14: 10.3 ↙	19: 10.4 ←	
15: 10.9x ↗	20: 9.9 ↗	

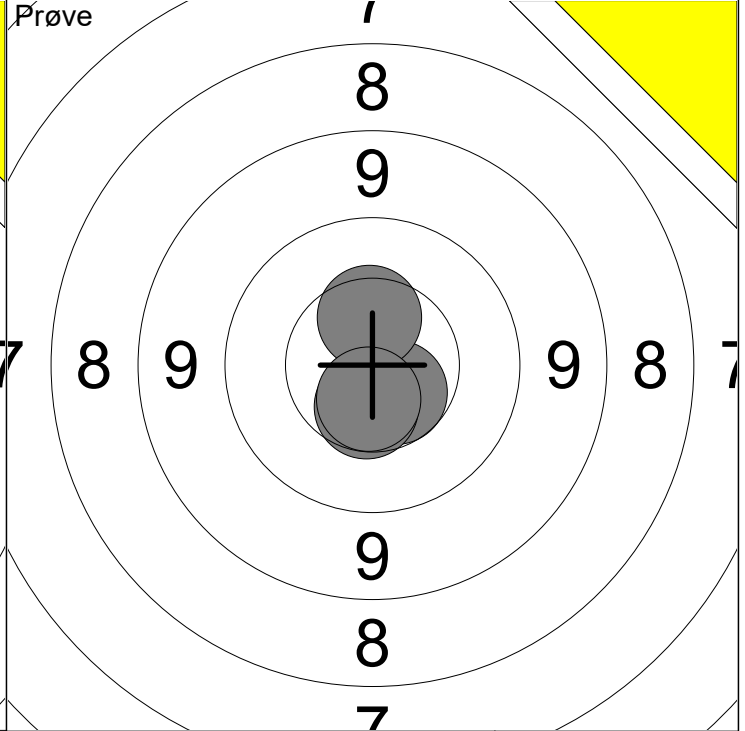
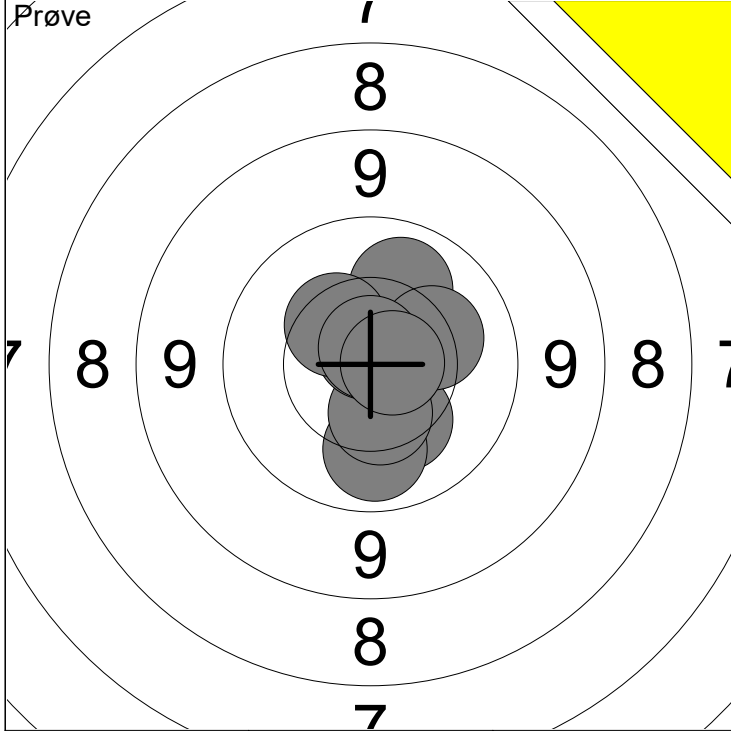

1: 10.3 ↘	6: 10.8x ↗	Serie 100 (4x)
2: 10.1 ↘	7: 10.4 ↖	
3: 10.7x →	8: 10.3 →	Total 0 (0x)
4: 10.1 ↗	9: 10.8x ↗	
5: 10.4 ↘	10: 10.7x →	

11: 10.6 ↘	Serie 40 (1x)
12: 10.4 ↗	
13: 10.5 ↘	Total 0 (0x)
14: 10.6x ↘	

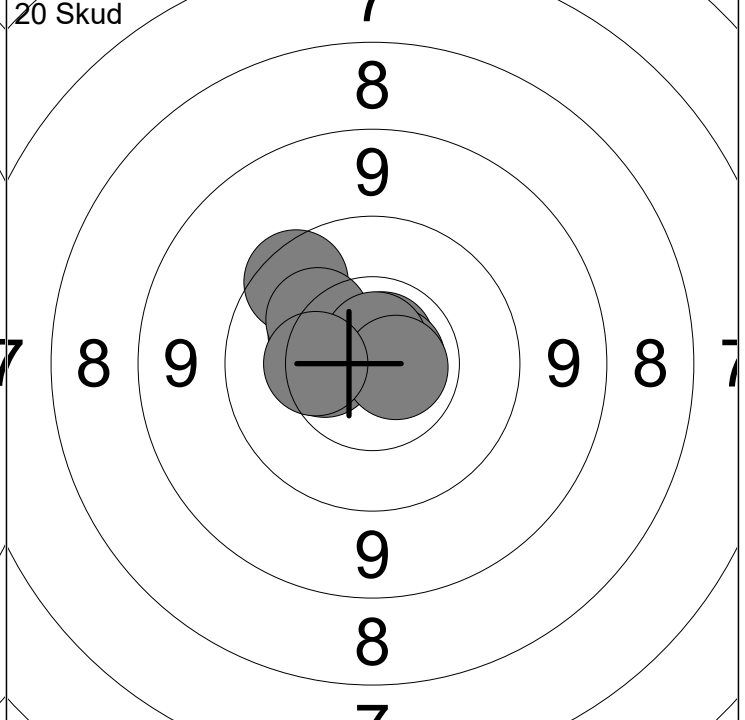
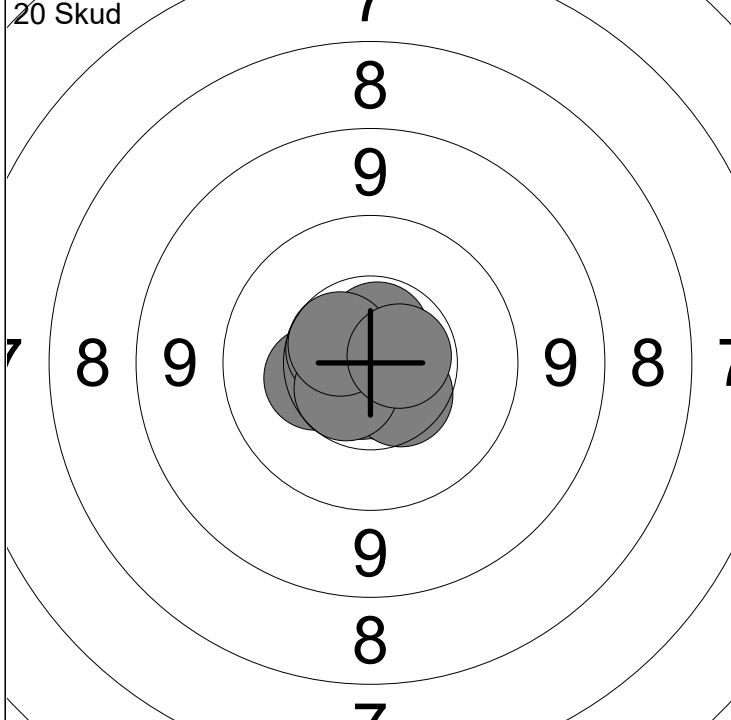

1: 10.6x ↘	6: 10.6 ↖	Serie 100 (5x)
2: 10.7x ↘	7: 10.6x ↗	
3: 10.9x ↘	8: 10.6 ↘	Total 100 (5x)
4: 10.4 ←	9: 10.6 ↖	
5: 10.5 ↘	10: 10.6x →	

11: 10.7x ↗	Serie 99 (4x)
12: 10.6 ↖	
13: 9.8 ↖	Total 199 (9x)
14: 10.7x →	
15: 10.3 ↖	
16: 10.4 ←	
17: 10.2 ↖	
18: 10.7x ↗	
19: 10.7x →	
20: 10.4 ←	

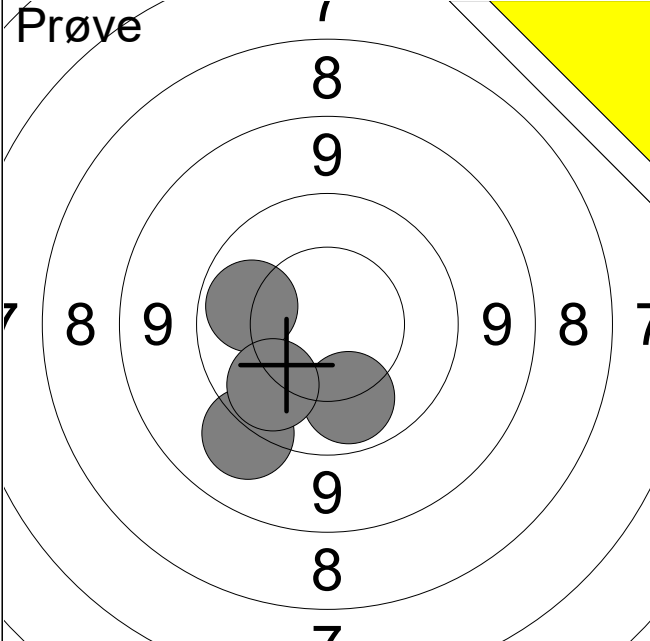
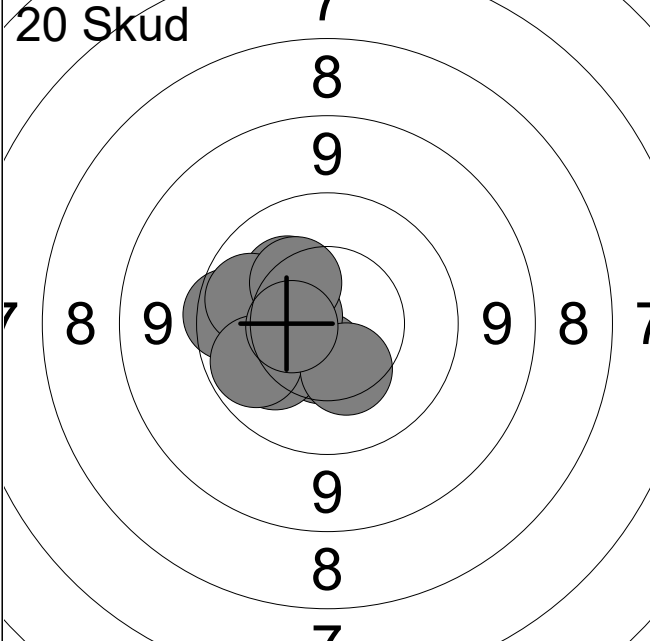
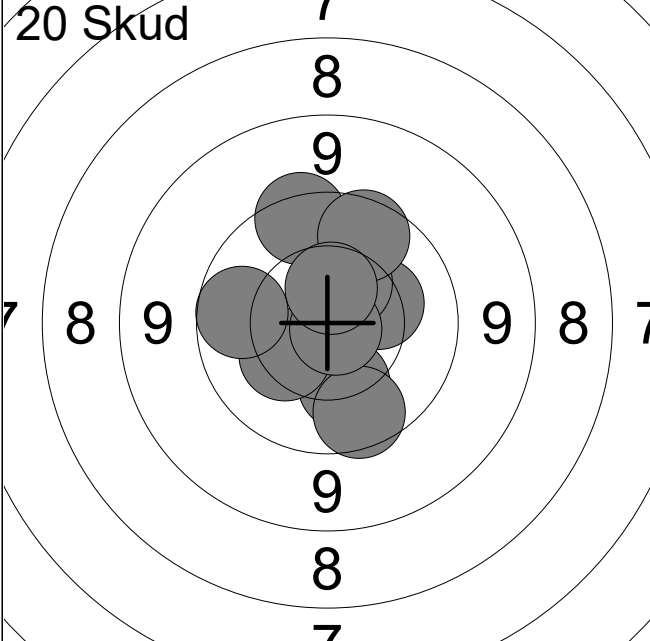
Hold 13	Skive 6	Jette Johansen																																
ØSF		Frederikssund Skytteforening, I		FRI2																														
28.10.2024		Halloween Luftstævne 2024		Ølstykke skytteforening																														
Prøve		<table border="0"> <tr><td>1:</td><td>10.0</td><td>←</td></tr> <tr><td>2:</td><td>9.3</td><td>↘</td></tr> <tr><td>3:</td><td>10.1</td><td>↘</td></tr> <tr><td>4:</td><td>10.0</td><td>↘</td></tr> </table>			1:	10.0	←	2:	9.3	↘	3:	10.1	↘	4:	10.0	↘																		
1:	10.0	←																																
2:	9.3	↘																																
3:	10.1	↘																																
4:	10.0	↘																																
		<table border="0"> <tr><td>Serie</td><td colspan="2">39 (0x)</td></tr> <tr><td>Total</td><td colspan="2">0 (0x)</td></tr> </table>			Serie	39 (0x)		Total	0 (0x)																									
Serie	39 (0x)																																	
Total	0 (0x)																																	
20 Skud		<table border="0"> <tr><td>1:</td><td>10.5</td><td>↓</td></tr> <tr><td>2:</td><td>10.6</td><td>←</td></tr> <tr><td>3:</td><td>9.8</td><td>←</td></tr> <tr><td>4:</td><td>10.3</td><td>↗</td></tr> <tr><td>5:</td><td>10.0</td><td>←</td></tr> <tr><td>6:</td><td>10.2</td><td>↘</td></tr> <tr><td>7:</td><td>10.0</td><td>←</td></tr> <tr><td>8:</td><td>10.3</td><td>↗</td></tr> <tr><td>9:</td><td>10.4</td><td>↓</td></tr> <tr><td>10:</td><td>10.5</td><td>←</td></tr> </table>			1:	10.5	↓	2:	10.6	←	3:	9.8	←	4:	10.3	↗	5:	10.0	←	6:	10.2	↘	7:	10.0	←	8:	10.3	↗	9:	10.4	↓	10:	10.5	←
1:	10.5	↓																																
2:	10.6	←																																
3:	9.8	←																																
4:	10.3	↗																																
5:	10.0	←																																
6:	10.2	↘																																
7:	10.0	←																																
8:	10.3	↗																																
9:	10.4	↓																																
10:	10.5	←																																
		<table border="0"> <tr><td>Serie</td><td colspan="2">99 (0x)</td></tr> <tr><td>Total</td><td colspan="2">99 (0x)</td></tr> </table>			Serie	99 (0x)		Total	99 (0x)																									
Serie	99 (0x)																																	
Total	99 (0x)																																	
20 Skud		<table border="0"> <tr><td>11:</td><td>10.2</td><td>↓</td></tr> <tr><td>12:</td><td>10.3</td><td>↗</td></tr> <tr><td>13:</td><td>9.7</td><td>↑</td></tr> <tr><td>14:</td><td>10.3</td><td>↘</td></tr> <tr><td>15:</td><td>10.4</td><td>↗</td></tr> <tr><td>16:</td><td>9.8</td><td>↓</td></tr> <tr><td>17:</td><td>9.9</td><td>←</td></tr> <tr><td>18:</td><td>10.8x</td><td>↘</td></tr> <tr><td>19:</td><td>9.8</td><td>↑</td></tr> <tr><td>20:</td><td>10.5</td><td>↑</td></tr> </table>			11:	10.2	↓	12:	10.3	↗	13:	9.7	↑	14:	10.3	↘	15:	10.4	↗	16:	9.8	↓	17:	9.9	←	18:	10.8x	↘	19:	9.8	↑	20:	10.5	↑
11:	10.2	↓																																
12:	10.3	↗																																
13:	9.7	↑																																
14:	10.3	↘																																
15:	10.4	↗																																
16:	9.8	↓																																
17:	9.9	←																																
18:	10.8x	↘																																
19:	9.8	↑																																
20:	10.5	↑																																
		<table border="0"> <tr><td>Serie</td><td colspan="2">96 (1x)</td></tr> <tr><td>Total</td><td colspan="2">195 (1x)</td></tr> </table>			Serie	96 (1x)		Total	195 (1x)																									
Serie	96 (1x)																																	
Total	195 (1x)																																	

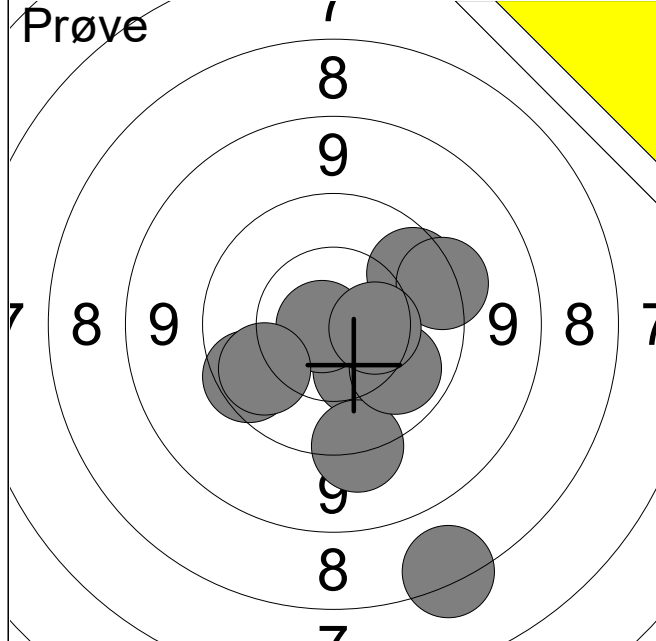

1:	7.5	↘
2:	9.8	↗
3:	10.3	↘
4:	9.5	↗
5:	10.8x	←
6:	9.8	↙
7:	9.4	↘
8:	10.0	↙
9:	10.1	↘
10:	10.5	→

Serie 93 (1x)

Total 0 (0x)

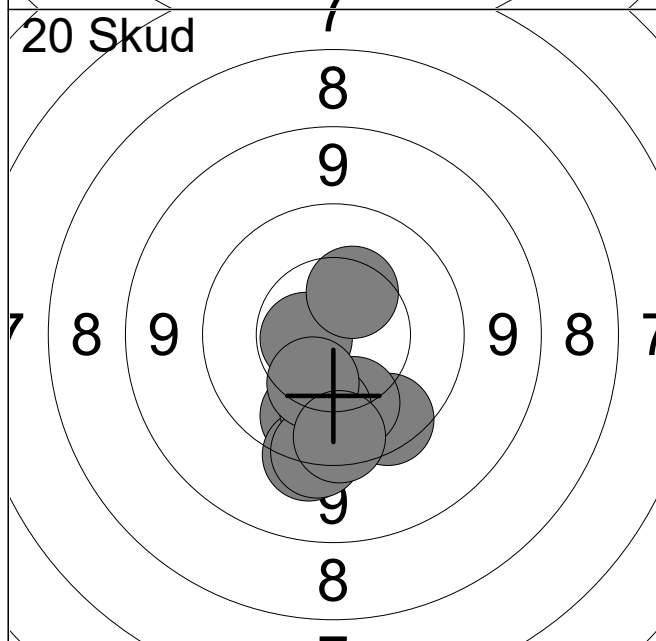

1:	9.7	↘
2:	9.9	↘
3:	10.1	↘
4:	10.6x	←
5:	9.5	↘
6:	10.1	↘
7:	9.5	↘
8:	10.3	↘
9:	10.4	↗
10:	9.7	↘

Serie 95 (1x)

Total 95 (1x)

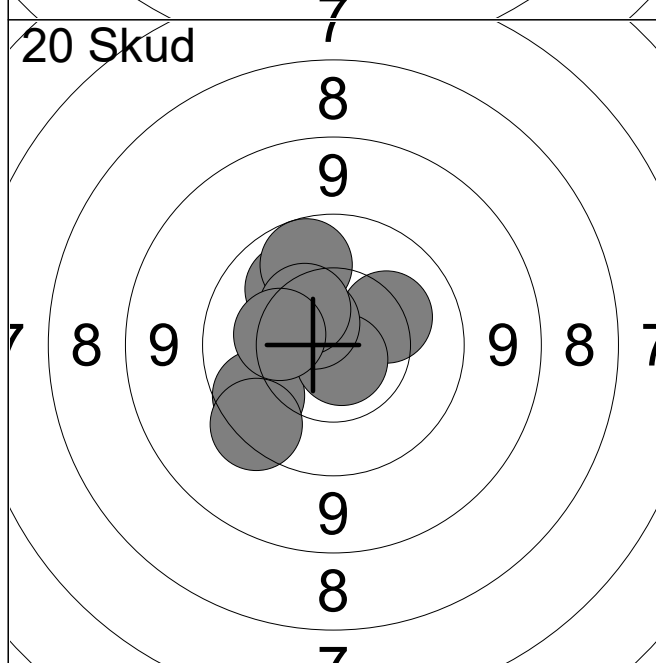

11:	10.2	↗
12:	10.6x	↙
13:	10.1	↗
14:	9.9	↙
15:	10.8x	↘
16:	9.6	↙
17:	10.6x	↗
18:	9.9	↗
19:	10.4	↗
20:	10.3	↙

Serie 97 (3x)

Total 192 (4x)

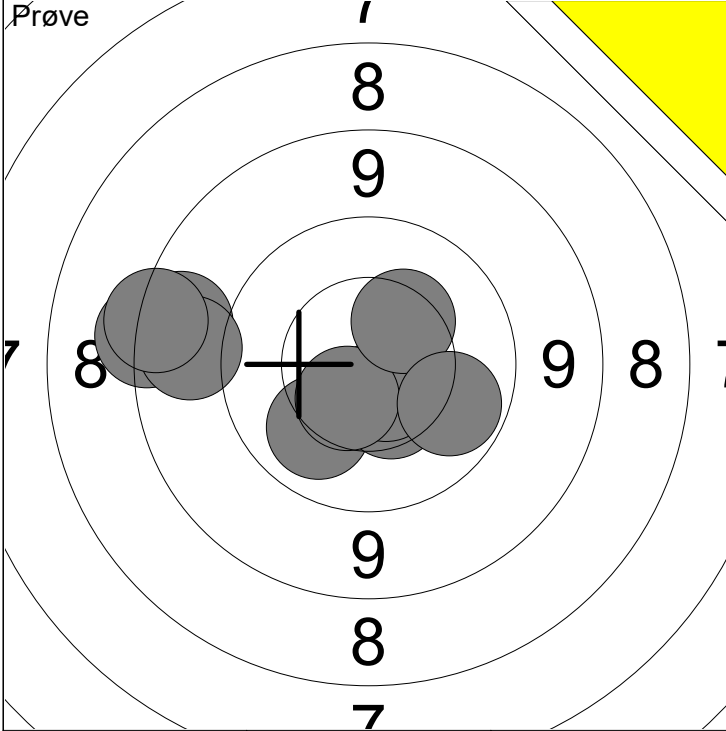

1: 8.5 ←	6: 10.4 ↓	Serie	93 (1x)
2: 8.8 ←	7: 10.6x ↓		
3: 9.0 ←	8: 10.5 ↓	Total	0 (0x)
4: 8.5 ←	9: 10.4 ↗		
5: 10.1 ↘	10: 10.0 ↘		

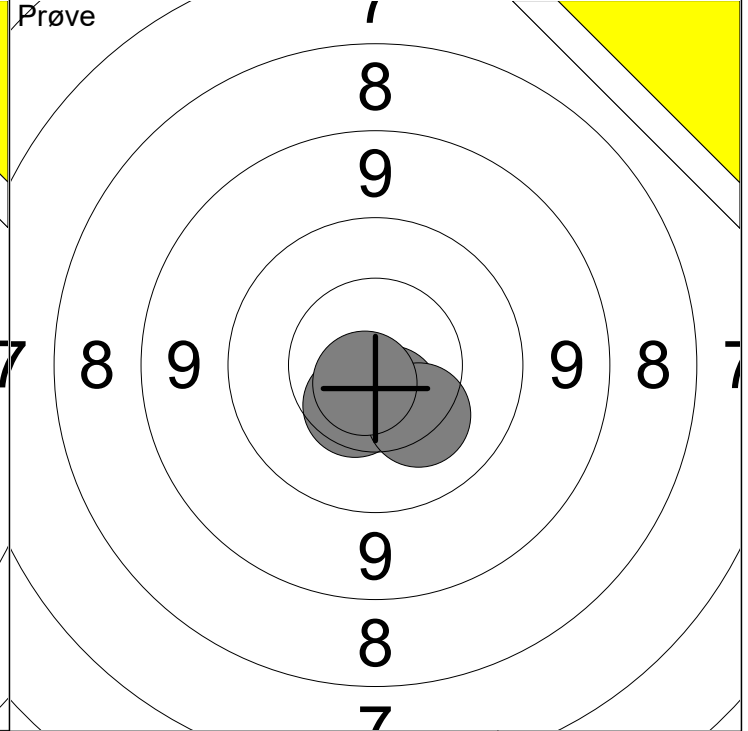

11: 10.6 ↓	Serie	40 (1x)
12: 10.5 ↓		
13: 10.3 ↓	Total	0 (0x)
14: 10.7x ↓		

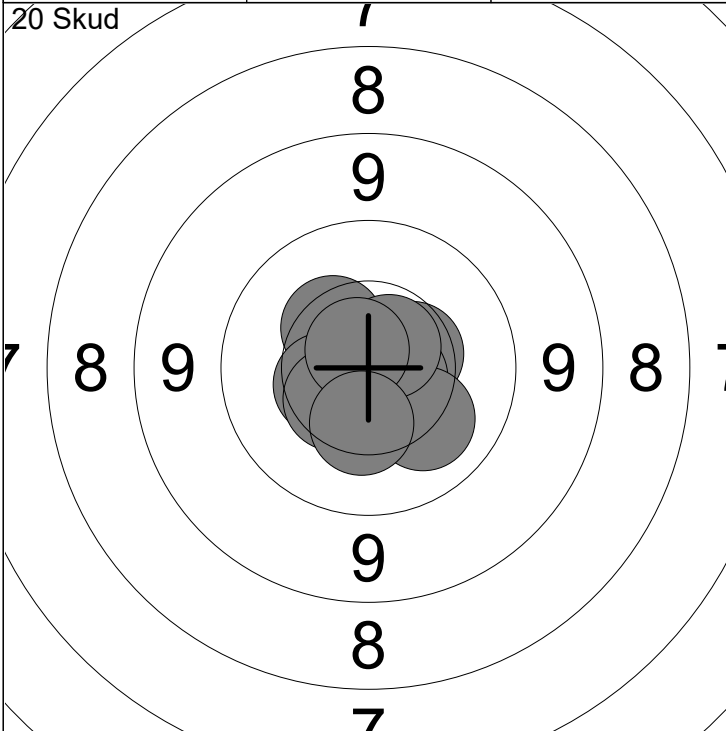

1: 10.5 →	6: 10.5 ←	Serie	100 (4x)
2: 10.6x →	7: 10.5 ↓		
3: 10.6x ↗	8: 10.6x ↗	Total	100 (4x)
4: 10.2 ↓	9: 10.7x ↗		
5: 10.4 ↗	10: 10.4 ↓		

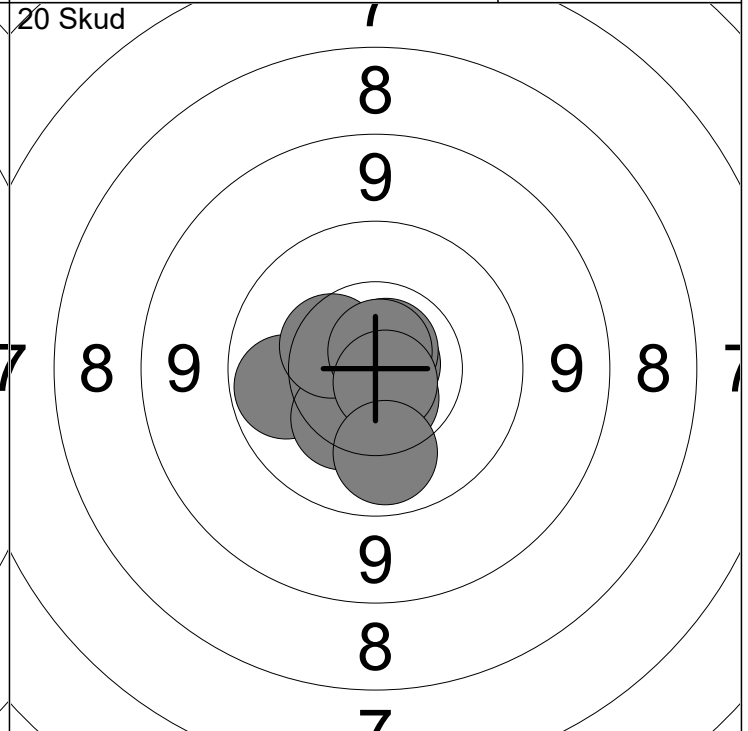

11: 10.4 ↓	Serie	100 (5x)
12: 10.8x →		
13: 10.0 ←	Total	200 (9x)
14: 10.6x ↓		
15: 10.3 ↓		

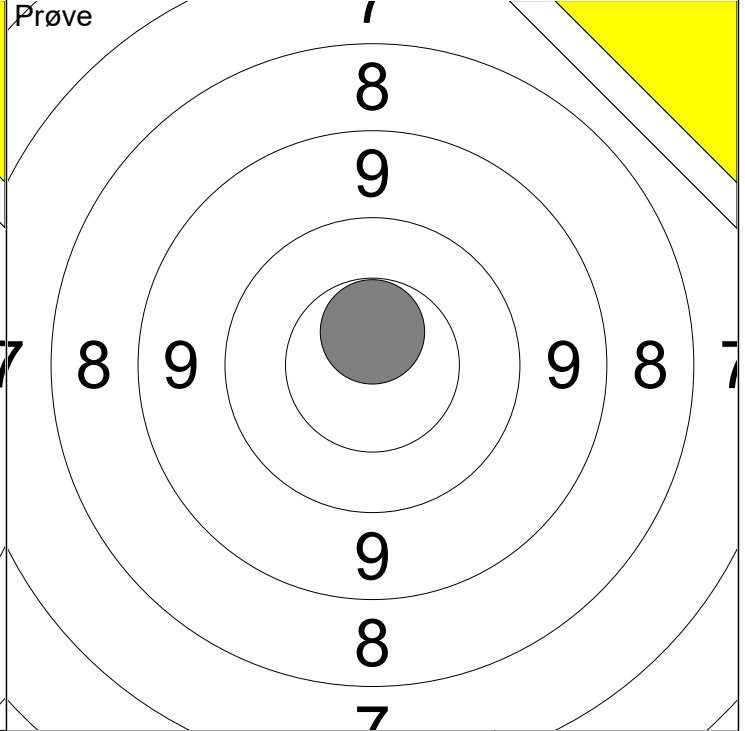
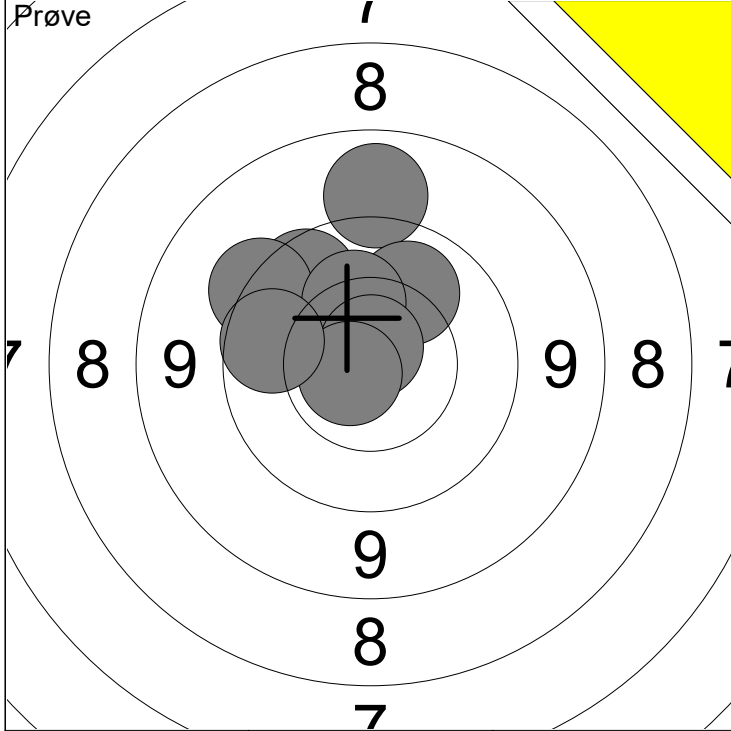

1: 9.1 ↑	6: 10.1 ↗	Serie 96 (3x)
2: 10.3 ↑	7: 10.3 ↑	
3: 9.8 ↘	8: 10.8x ↑	Total 0 (0x)
4: 9.5 ↖	9: 10.7x ←	
5: 10.7x ↑	10: 9.9 ←	

11: 10.6x ↑	Serie 10 (1x)
	Total 0 (0x)

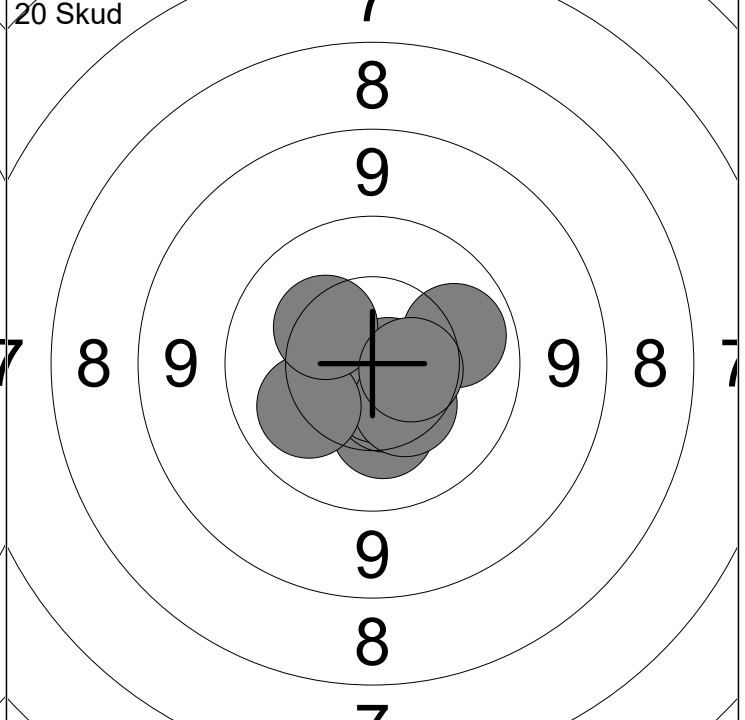
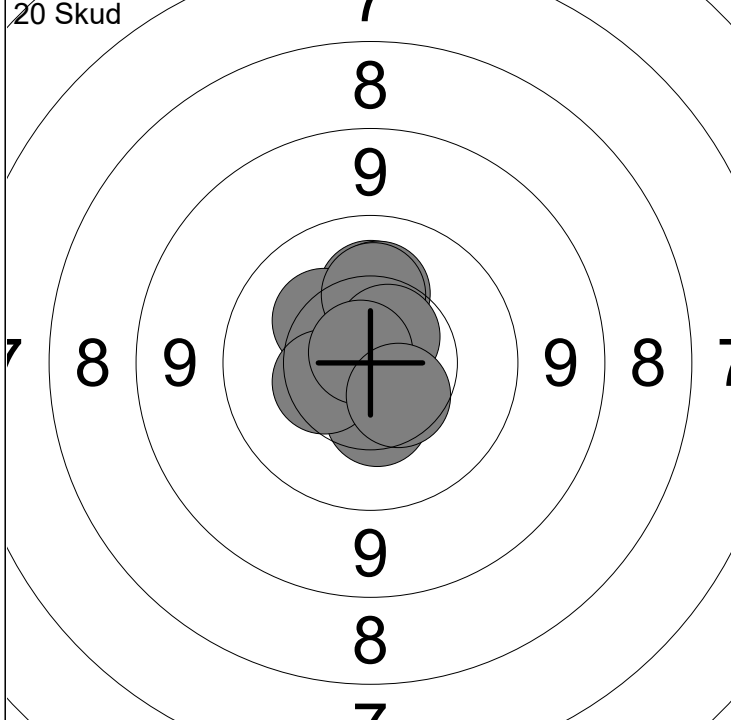

1: 10.2 ↑	6: 10.2 ↑	Serie 100 (3x)
2: 10.6x ↘	7: 10.4 ←	
3: 10.4 ↓	8: 10.6x ↗	Total 100 (3x)
4: 10.3 ↖	9: 10.8x ↘	
5: 10.2 ↑	10: 10.5 ↓	

11: 10.3 ↓	16: 10.4 ↓	Serie 100 (2x)
12: 10.5 ↓	17: 10.1 ↖	
13: 10.8x →	18: 10.0 →	Total 200 (5x)
14: 10.5 ↓	19: 10.3 ↘	
15: 10.7x ↓	20: 10.5 →	

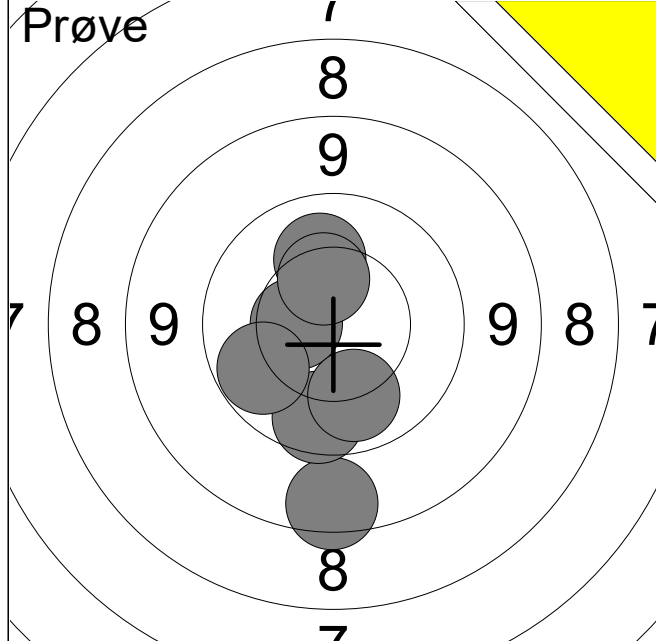

1:	8.7	↓
2:	9.8	↓
3:	10.5	←
4:	10.0	↙
5:	10.1	↓
6:	10.2	↑
7:	10.4	↑
Serie		67 (0x)
Total		0 (0x)

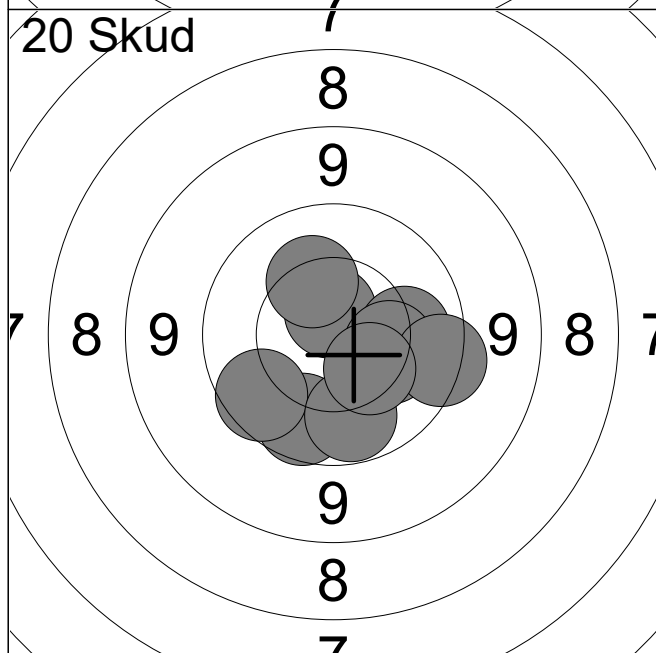

1:	10.7x	↑
2:	10.2	→
3:	9.9	↓
4:	10.3	↑
5:	9.8	↙
6:	10.1	→
7:	10.0	↓
8:	10.3	→
9:	9.6	→
10:	10.4	↓
Serie		97 (1x)
Total		97 (1x)

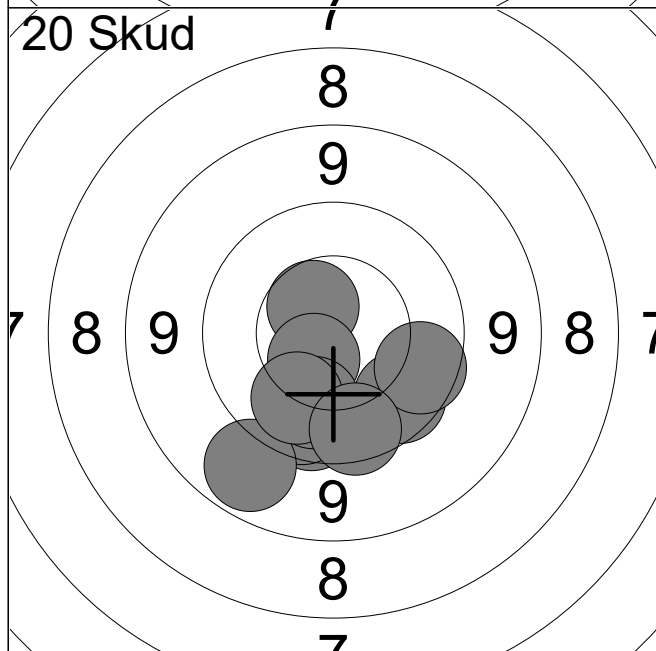

11:	9.8	↓
12:	10.6	↗
13:	9.9	↓
14:	10.6	↙
15:	9.0	↓
16:	10.1	↓
17:	9.9	↘
18:	10.1	↙
19:	9.8	→
20:	9.8	↓
Serie		94 (0x)
Total		191 (1x)

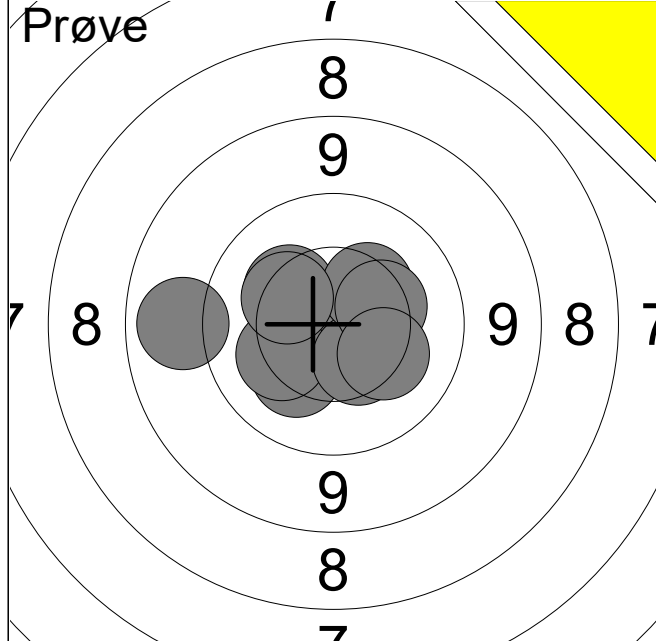

1:	10.5	↙
2:	10.2	↓
3:	10.3	↗
4:	10.2	↙
5:	10.4	↓
6:	9.1	←
7:	10.4	↗
8:	10.3	→
9:	10.3	↗
10:	10.3	↘
Serie		99 (0x)
Total		0 (0x)

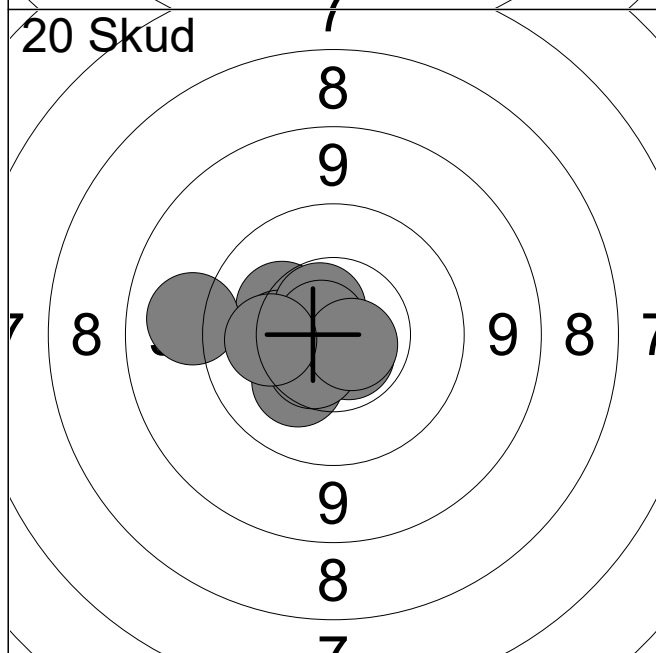

1:	10.3	↗
2:	10.3	←
3:	10.7x	↓
4:	10.3	↘
5:	10.6x	↗
6:	10.8x	↗
7:	9.2	←
8:	10.5	↘
9:	10.7x	↘
10:	10.2	←
Serie		99 (4x)
Total		99 (4x)

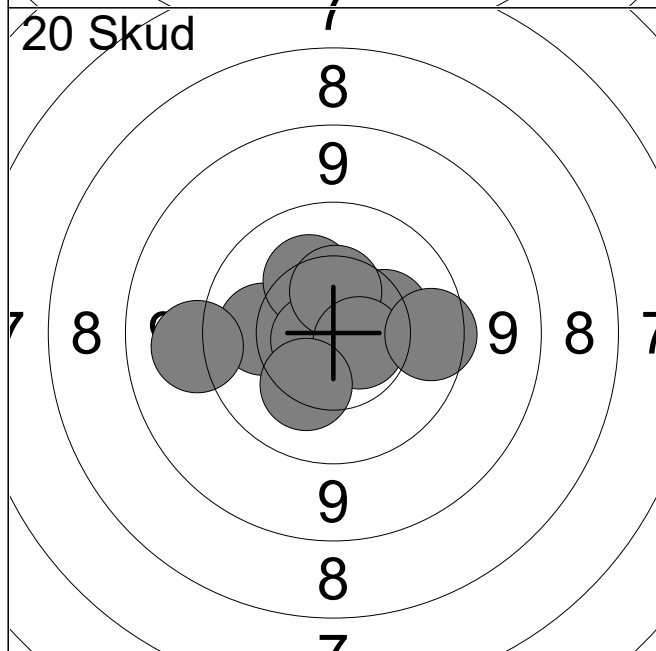

11:	10.7x	←
12:	10.1	←
13:	10.3	→
14:	10.3	↗
15:	10.7x	←
16:	10.5	↑
17:	10.6x	↘
18:	9.3	←
19:	10.3	↘
20:	9.8	→
Serie		98 (3x)
Total		197 (7x)

Hold	Skive	Carl-Emil Asmussen																																						
14	3	Frederikssund Skytteforening, I		MJ1																																				
28.10.2024	Halloween Luftstævne 2024	Ølstykke skytteforening																																						
Prøve		<table border="1"> <tr><td>1:</td><td>10.2</td><td>→</td></tr> <tr><td>2:</td><td>10.6</td><td>→</td></tr> <tr><td>3:</td><td>10.8x</td><td>↑</td></tr> <tr><td>4:</td><td>10.7x</td><td>→</td></tr> <tr><td>5:</td><td>10.8x</td><td>↓</td></tr> <tr><td>6:</td><td>10.2</td><td>→</td></tr> <tr><td>7:</td><td>10.6x</td><td>↗</td></tr> <tr><td colspan="2">Serie</td><td>70 (4x)</td></tr> <tr><td colspan="2">Total</td><td>0 (0x)</td></tr> </table>			1:	10.2	→	2:	10.6	→	3:	10.8x	↑	4:	10.7x	→	5:	10.8x	↓	6:	10.2	→	7:	10.6x	↗	Serie		70 (4x)	Total		0 (0x)									
1:	10.2	→																																						
2:	10.6	→																																						
3:	10.8x	↑																																						
4:	10.7x	→																																						
5:	10.8x	↓																																						
6:	10.2	→																																						
7:	10.6x	↗																																						
Serie		70 (4x)																																						
Total		0 (0x)																																						
20 Skud		<table border="1"> <tr><td>1:</td><td>9.9</td><td>↑</td></tr> <tr><td>2:</td><td>10.6x</td><td>↘</td></tr> <tr><td>3:</td><td>10.8x</td><td>↘</td></tr> <tr><td>4:</td><td>10.5</td><td>↑</td></tr> <tr><td>5:</td><td>10.5</td><td>↘</td></tr> <tr><td>6:</td><td>10.3</td><td>↙</td></tr> <tr><td>7:</td><td>10.9x</td><td>↗</td></tr> <tr><td>8:</td><td>10.8x</td><td>←</td></tr> <tr><td>9:</td><td>10.4</td><td>↓</td></tr> <tr><td>10:</td><td>10.9x</td><td>←</td></tr> <tr><td colspan="2">Serie</td><td>99 (5x)</td></tr> <tr><td colspan="2">Total</td><td>99 (5x)</td></tr> </table>			1:	9.9	↑	2:	10.6x	↘	3:	10.8x	↘	4:	10.5	↑	5:	10.5	↘	6:	10.3	↙	7:	10.9x	↗	8:	10.8x	←	9:	10.4	↓	10:	10.9x	←	Serie		99 (5x)	Total		99 (5x)
1:	9.9	↑																																						
2:	10.6x	↘																																						
3:	10.8x	↘																																						
4:	10.5	↑																																						
5:	10.5	↘																																						
6:	10.3	↙																																						
7:	10.9x	↗																																						
8:	10.8x	←																																						
9:	10.4	↓																																						
10:	10.9x	←																																						
Serie		99 (5x)																																						
Total		99 (5x)																																						
20 Skud		<table border="1"> <tr><td>11:</td><td>10.3</td><td>↘</td></tr> <tr><td>12:</td><td>10.6</td><td>↘</td></tr> <tr><td>13:</td><td>10.4</td><td>↗</td></tr> <tr><td>14:</td><td>9.8</td><td>→</td></tr> <tr><td>15:</td><td>10.6</td><td>↓</td></tr> <tr><td>16:</td><td>10.5</td><td>↗</td></tr> <tr><td>17:</td><td>10.7x</td><td>↓</td></tr> <tr><td>18:</td><td>9.1</td><td>↗</td></tr> <tr><td>19:</td><td>10.3</td><td>↗</td></tr> <tr><td>20:</td><td>10.3</td><td>↗</td></tr> <tr><td colspan="2">Serie</td><td>98 (1x)</td></tr> <tr><td colspan="2">Total</td><td>197 (6x)</td></tr> </table>			11:	10.3	↘	12:	10.6	↘	13:	10.4	↗	14:	9.8	→	15:	10.6	↓	16:	10.5	↗	17:	10.7x	↓	18:	9.1	↗	19:	10.3	↗	20:	10.3	↗	Serie		98 (1x)	Total		197 (6x)
11:	10.3	↘																																						
12:	10.6	↘																																						
13:	10.4	↗																																						
14:	9.8	→																																						
15:	10.6	↓																																						
16:	10.5	↗																																						
17:	10.7x	↓																																						
18:	9.1	↗																																						
19:	10.3	↗																																						
20:	10.3	↗																																						
Serie		98 (1x)																																						
Total		197 (6x)																																						

Hold	Skive	Stine Kongsted		
14	4	ØSF	Frederikssund Skytteforening, I	Å1
28.10.2024	Halloween Luftstævne 2024	Ølstykke skytteforening		
Prøve		1:	8.9	↑
		2:	10.4	↑
		3:	10.5	↑
		4:	10.6x	→
		5:	10.6	→
		Serie		48 (1x)
Total		0 (0x)		
20 Skud		1:	9.7	↗
		2:	10.3	↑
		3:	10.5	↗
		4:	10.7x	↘
		5:	10.6	↘
		6:	10.7x	↘
		7:	10.0	↗
		8:	10.4	↘
		9:	10.0	→
		10:	10.4	↗
		Serie		99 (2x)
Total		99 (2x)		
20 Skud		11:	10.6x	↙
		12:	10.4	↘
		13:	10.6	→
		14:	10.5	↘
		15:	9.8	→
		16:	10.0	→
		17:	10.6x	↑
		18:	10.7x	→
		19:	10.6	↙
		20:	9.8	↘
		Serie		98 (3x)
Total		197 (5x)		

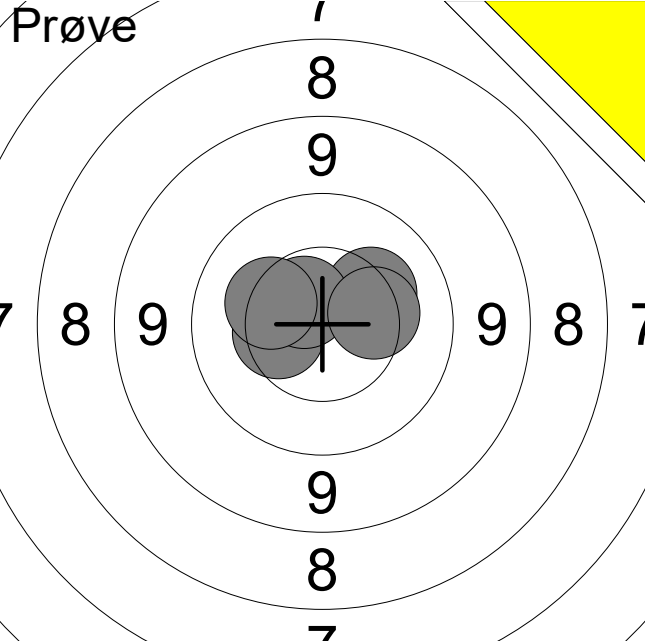
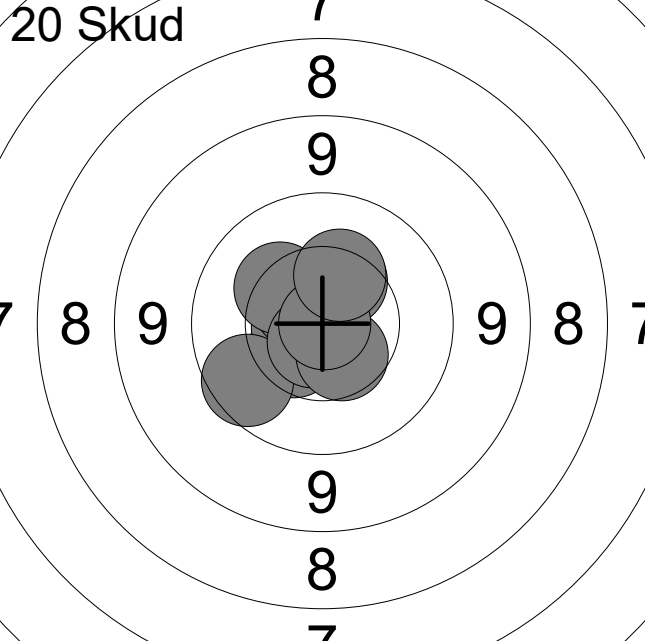
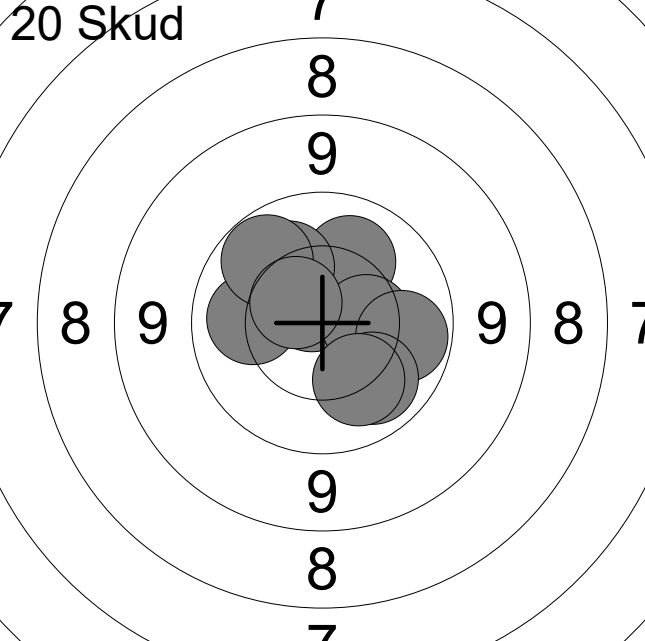
Hold	Skive	Kean Kofoed Noerskov																																
14	8	Frederikssund Skytteforening, I		MÅ2																														
28.10.2024	Halloween Luftstævne 2024	Ølstykke skytteforening																																
Prøve	7	<table border="0"> <tr><td>1:</td><td>10.3</td><td>↗</td></tr> <tr><td>2:</td><td>10.4</td><td>←</td></tr> <tr><td>3:</td><td>10.6x</td><td>↗</td></tr> <tr><td>4:</td><td>10.3</td><td>←</td></tr> <tr><td>5:</td><td>10.3</td><td>→</td></tr> </table>			1:	10.3	↗	2:	10.4	←	3:	10.6x	↗	4:	10.3	←	5:	10.3	→															
1:	10.3	↗																																
2:	10.4	←																																
3:	10.6x	↗																																
4:	10.3	←																																
5:	10.3	→																																
	8	Serie 50 (1x)																																
	9	Total 0 (0x)																																
20 Skud	7	<table border="0"> <tr><td>1:</td><td>10.5</td><td>↙</td></tr> <tr><td>2:</td><td>10.7x</td><td>←</td></tr> <tr><td>3:</td><td>10.6</td><td>↗</td></tr> <tr><td>4:</td><td>9.8</td><td>↙</td></tr> <tr><td>5:</td><td>10.4</td><td>↗</td></tr> <tr><td>6:</td><td>10.3</td><td>↗</td></tr> <tr><td>7:</td><td>10.7x</td><td>↙</td></tr> <tr><td>8:</td><td>10.5</td><td>↙</td></tr> <tr><td>9:</td><td>10.9x</td><td>→</td></tr> <tr><td>10:</td><td>10.3</td><td>↗</td></tr> </table>			1:	10.5	↙	2:	10.7x	←	3:	10.6	↗	4:	9.8	↙	5:	10.4	↗	6:	10.3	↗	7:	10.7x	↙	8:	10.5	↙	9:	10.9x	→	10:	10.3	↗
1:	10.5	↙																																
2:	10.7x	←																																
3:	10.6	↗																																
4:	9.8	↙																																
5:	10.4	↗																																
6:	10.3	↗																																
7:	10.7x	↙																																
8:	10.5	↙																																
9:	10.9x	→																																
10:	10.3	↗																																
	8	Serie 99 (3x)																																
	9	Total 99 (3x)																																
20 Skud	7	<table border="0"> <tr><td>11:</td><td>10.7x</td><td>↗</td></tr> <tr><td>12:</td><td>10.2</td><td>↗</td></tr> <tr><td>13:</td><td>10.4</td><td>→</td></tr> <tr><td>14:</td><td>10.2</td><td>↗</td></tr> <tr><td>15:</td><td>10.1</td><td>←</td></tr> <tr><td>16:</td><td>10.0</td><td>↗</td></tr> <tr><td>17:</td><td>10.6</td><td>↗</td></tr> <tr><td>18:</td><td>10.0</td><td>→</td></tr> <tr><td>19:</td><td>10.1</td><td>↙</td></tr> <tr><td>20:</td><td>10.2</td><td>↙</td></tr> </table>			11:	10.7x	↗	12:	10.2	↗	13:	10.4	→	14:	10.2	↗	15:	10.1	←	16:	10.0	↗	17:	10.6	↗	18:	10.0	→	19:	10.1	↙	20:	10.2	↙
11:	10.7x	↗																																
12:	10.2	↗																																
13:	10.4	→																																
14:	10.2	↗																																
15:	10.1	←																																
16:	10.0	↗																																
17:	10.6	↗																																
18:	10.0	→																																
19:	10.1	↙																																
20:	10.2	↙																																
	8	Serie 100 (1x)																																
	9	Total 199 (4x)																																

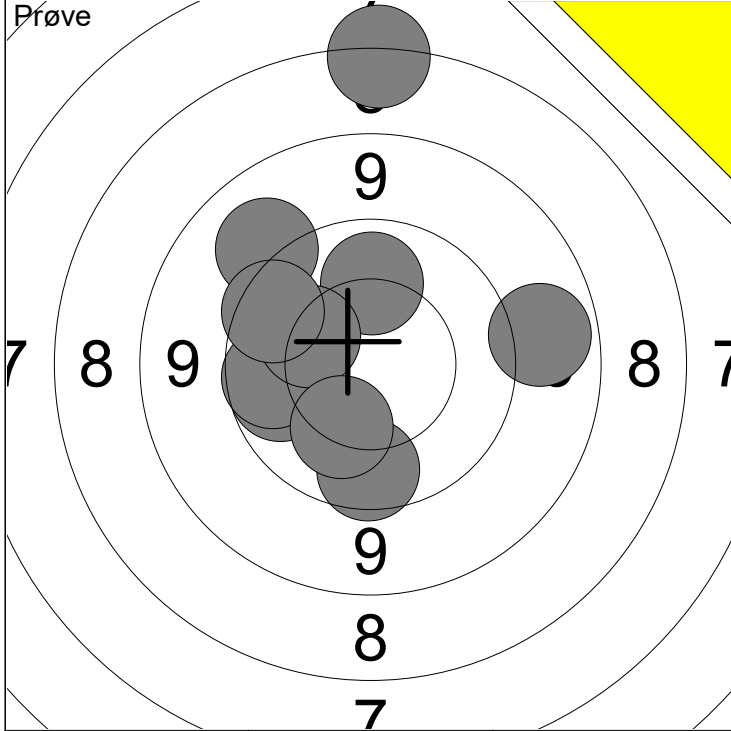

1: 7.4 ↑	6: 9.8 ↓
2: 9.2 ↘	7: 10.2 ↙
3: 10.0 ←	8: 9.0 →
4: 9.9 ←	9: 10.2 ↓
5: 10.1 ↑	10: 9.8 ↙

Serie	92 (0x)
Total	0 (0x)

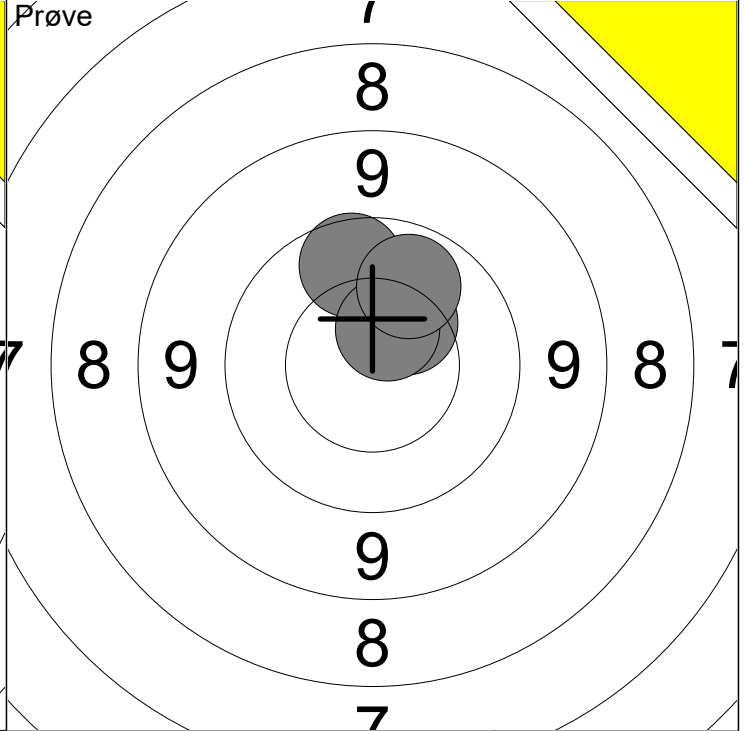

11: 10.4 ↗	12: 9.9 ↑
13: 10.5 ↑	14: 10.0 ↑

Serie	39 (0x)
Total	0 (0x)

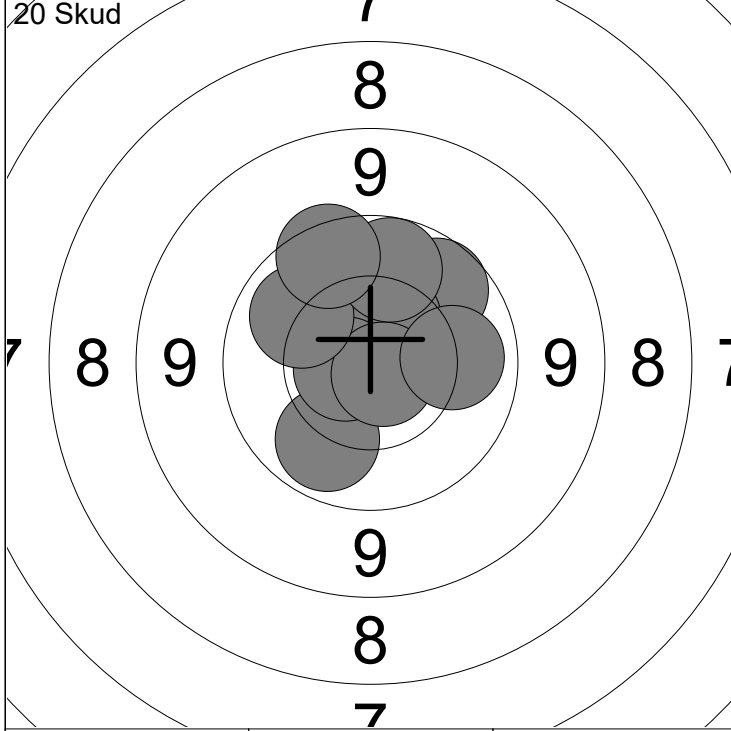

1: 9.9 ↗	6: 10.8x ↘
2: 10.6x ↑	7: 10.1 →
3: 10.0 ↓	8: 10.1 ↙
4: 10.5 ↑	9: 10.0 ↑
5: 10.7x ←	10: 9.7 ↑

Serie	98 (3x)
Total	98 (3x)

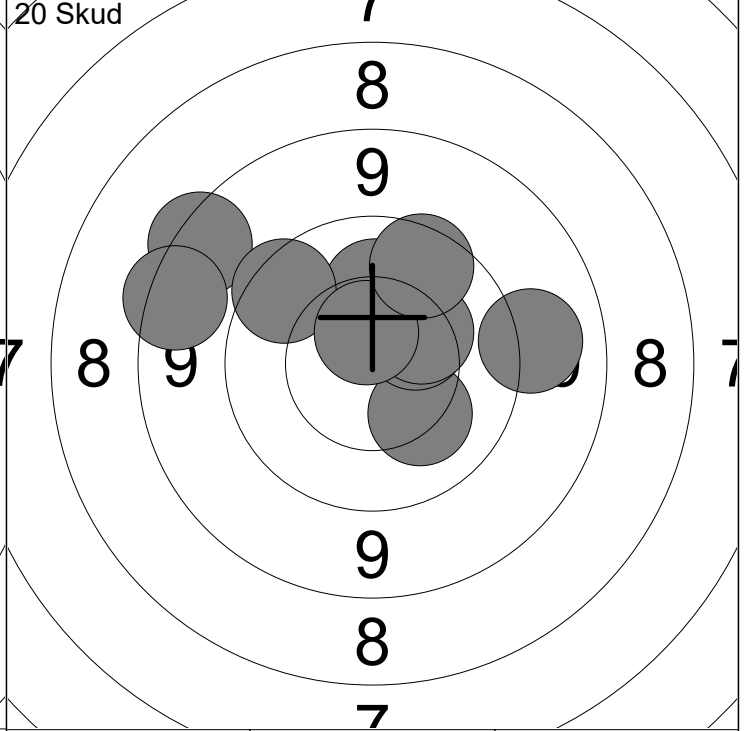

11: 10.2 ↘	12: 8.6 ↙	16: 9.2 →
13: 10.2 ↑	14: 10.4 ↗	17: 8.7 ↙
15: 10.3 ↗	18: 9.7 ↙	19: 10.6x ↑
	20: 9.8 ↑	

Serie	93 (1x)
Total	191 (4x)

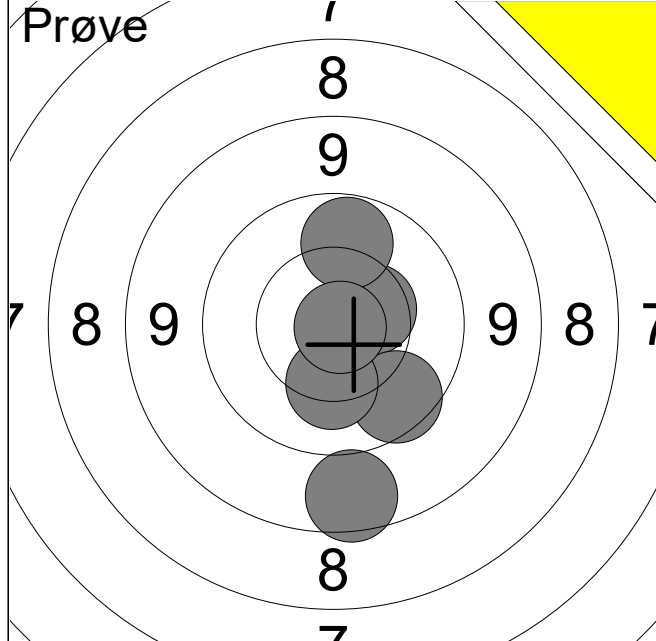

1:	10.5	→
2:	10.0	↑
3:	8.8	↓
4:	9.8	↘
5:	10.3	↓
6:	10.9x	→
Serie		57 (1x)
Total		0 (0x)

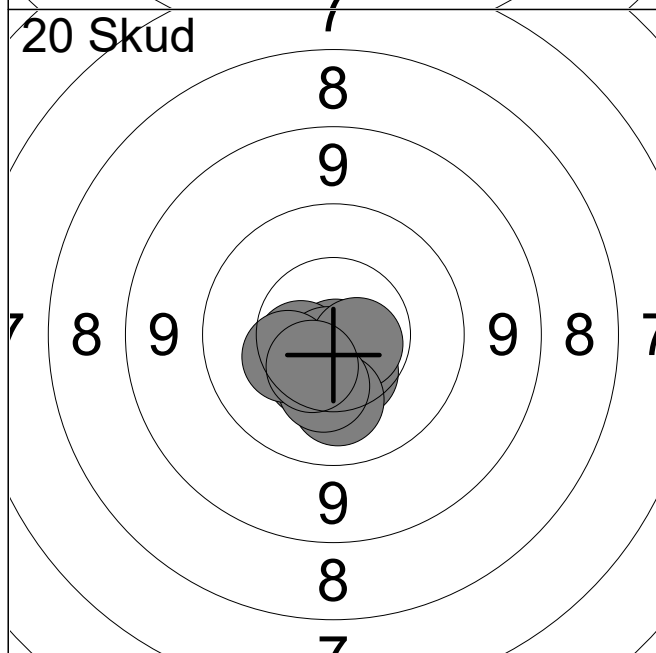

1:	10.5	↓
2:	10.8x	↓
3:	10.5	←
4:	10.7x	↓
5:	10.4	↘
6:	10.6x	→
7:	10.2	↓
8:	10.3	↓
9:	10.4	←
10:	10.5	↘
Serie		100 (3x)
Total		100 (3x)

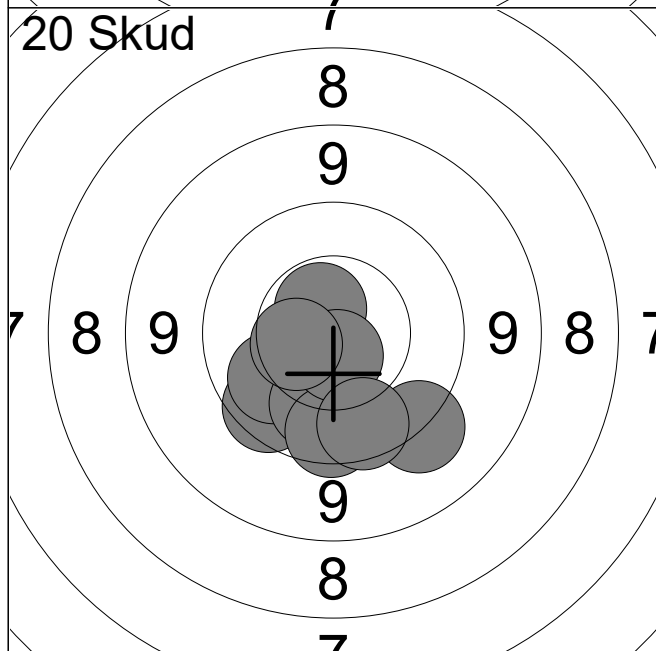

11:	10.6x	↘
12:	9.8	↘
13:	10.1	←
14:	10.6x	↗
15:	10.1	↓
16:	9.8	↓
17:	9.4	↘
18:	10.7x	↓
19:	10.5	←
20:	9.8	↓
Serie		96 (3x)
Total		196 (6x)

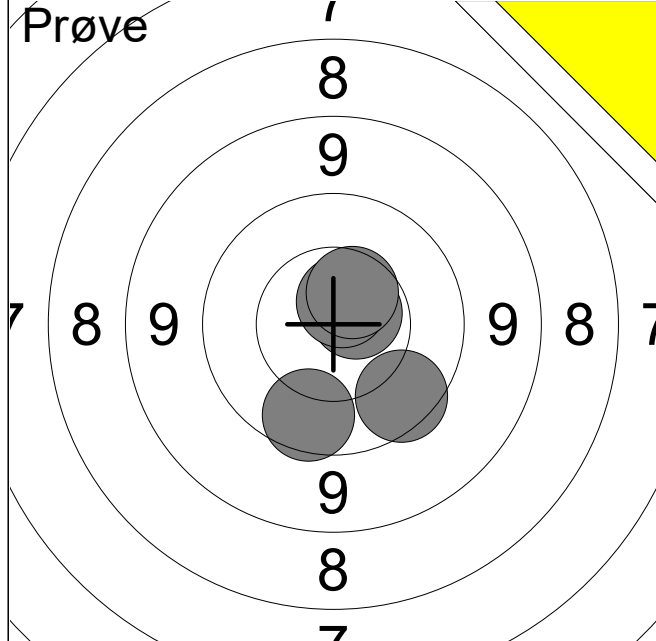

1:	9.8	↘
2:	10.7x	→
3:	9.8	↙
4:	10.7x	↑
5:	10.5	↑
Serie		48 (2x)
Total		0 (0x)

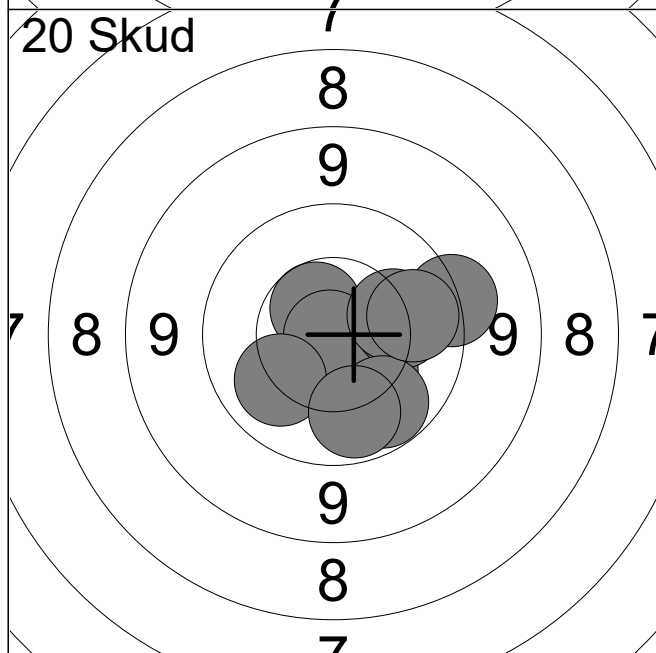

1:	10.3	↘
2:	10.6	↑
3:	10.9x	←
4:	10.1	↙
5:	9.5	→
6:	10.2	→
7:	10.2	→
8:	10.0	↙
9:	10.0	→
10:	10.0	↘
Serie		99 (1x)
Total		99 (1x)

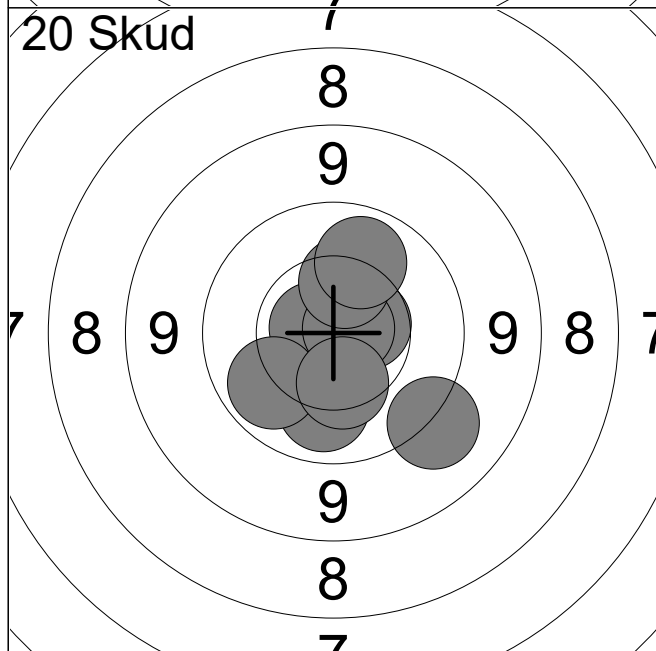

11:	10.1	↘
12:	10.6	→
13:	10.8x	↙
14:	10.7x	←
15:	10.8x	→
16:	10.0	↙
17:	9.3	↘
18:	10.3	↑
19:	10.3	↘
20:	10.1	↑
Serie		99 (3x)
Total		198 (4x)

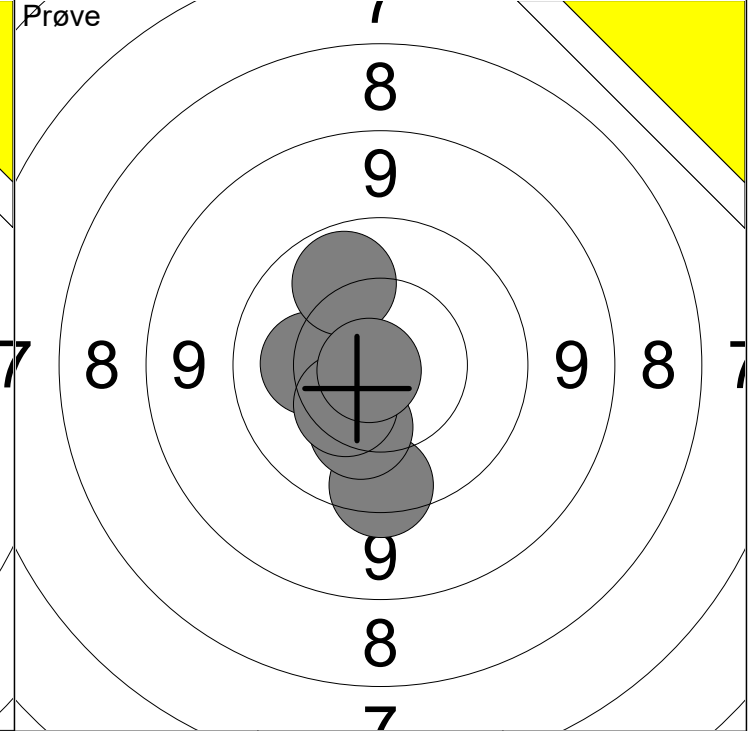
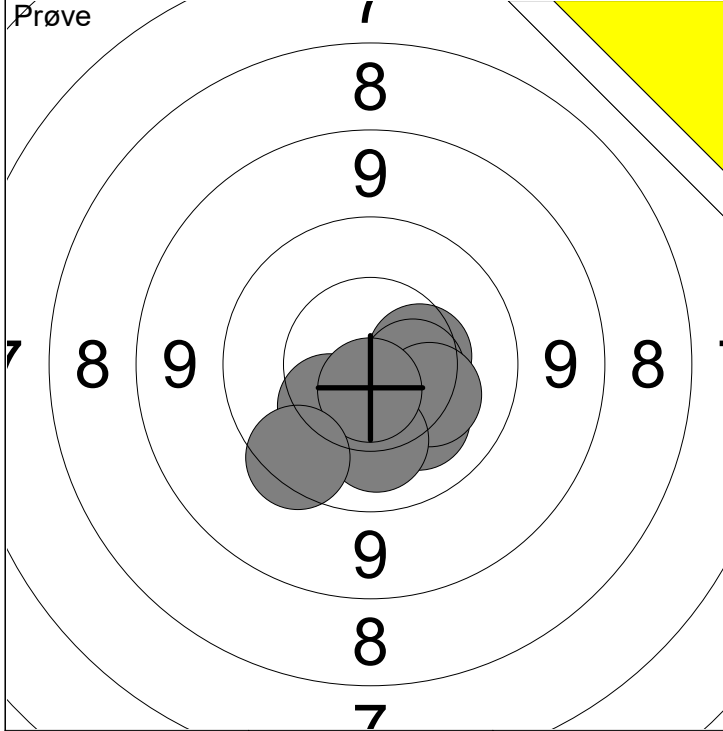

1: 10.2 ↘	6: 10.3 ↙	Serie 99 (1x)
2: 10.4 →	7: 10.3 →	
3: 10.4 →	8: 10.2 ↓	Total 0 (0x)
4: 10.5 →	9: 10.7x ↓	
5: 10.3 ↙	10: 9.7 ↙	

11: 10.2 ←	16: 10.8x ←	Serie 59 (1x)
12: 9.7 ↓	13: 10.3 ↓	
14: 10.0 ↗	15: 10.4 ↙	Total 0 (0x)

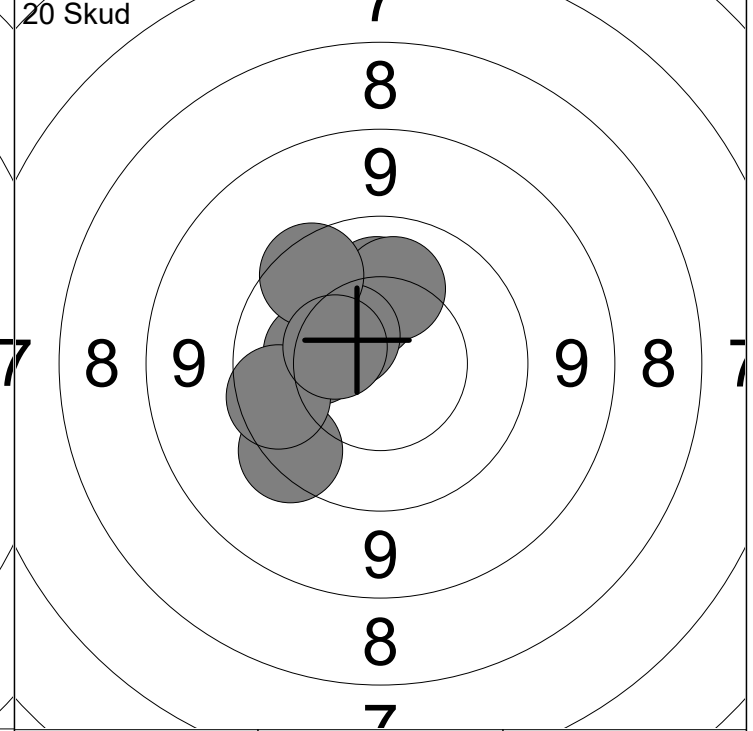
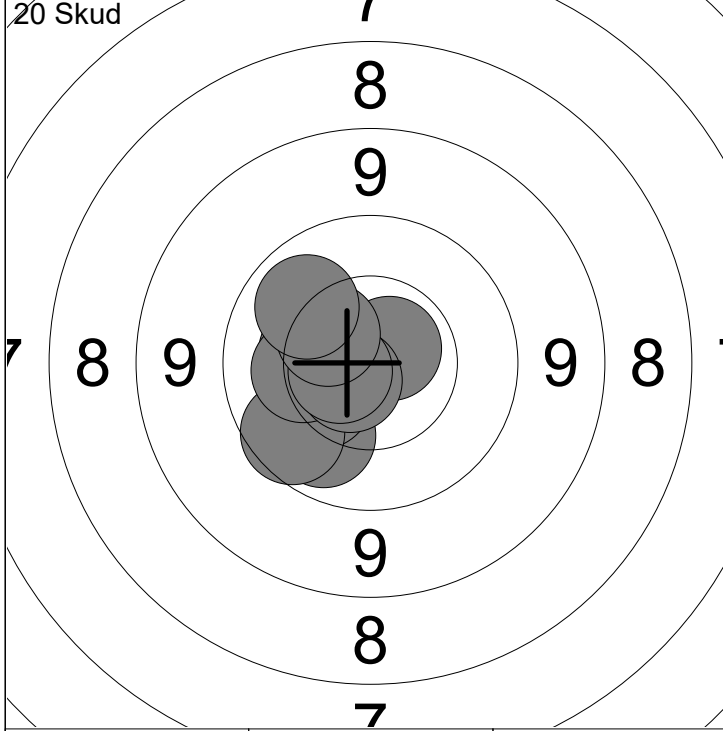

1: 10.0 ↙	6: 10.2 ←	Serie 99 (3x)
2: 10.7x ↗	7: 10.7x ↙	
3: 10.3 ↙	8: 10.6x ←	Total 99 (3x)
4: 9.8 ↙	9: 10.4 ↖	
5: 10.3 ←	10: 10.1 ↖	

11: 9.6 ↙	16: 9.8 ←	Serie 97 (0x)
12: 10.3 ←	17: 10.2 ↑	
13: 10.2 ↑	18: 10.5 ↖	Total 196 (3x)
14: 10.3 ↑	19: 9.8 ↖	
15: 10.5 ↖	20: 10.4 ←	

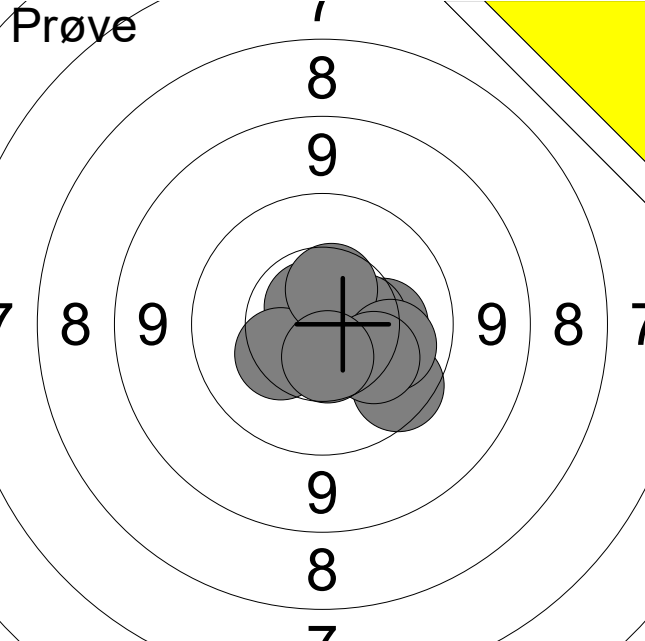
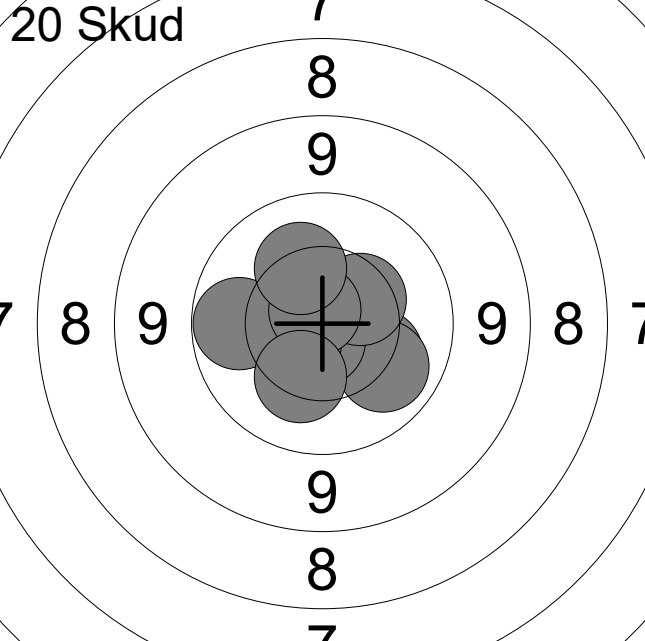
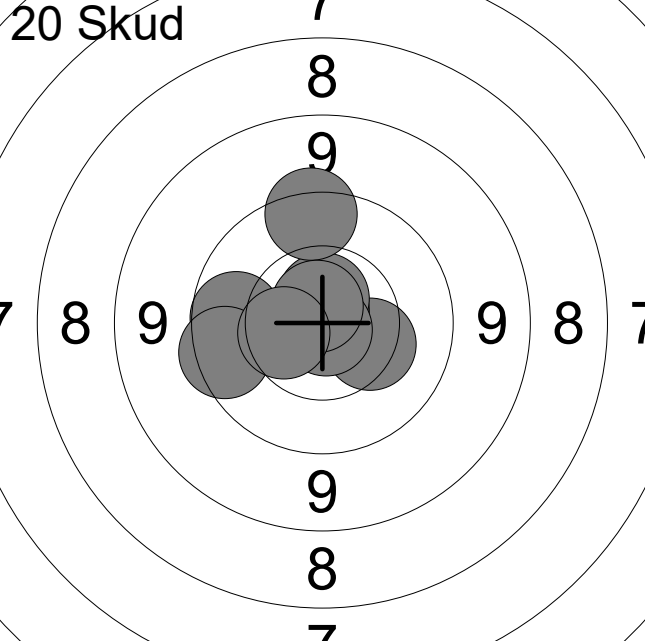
Hold 15	Skive 4	Mads Bredahl Christensen																																
ØSF		Frederikssund Skytteforening, I		MJ2																														
28.10.2024		Halloween Luftstævne 2024		Ølstykke skytteforening																														
Prøve		<table border="0"> <tr><td>1:</td><td>10.2</td><td>→</td></tr> <tr><td>2:</td><td>10.5</td><td>→</td></tr> <tr><td>3:</td><td>10.7x</td><td>↗</td></tr> <tr><td>4:</td><td>9.8</td><td>↘</td></tr> <tr><td>5:</td><td>10.3</td><td>↖</td></tr> <tr><td>6:</td><td>10.5</td><td>↗</td></tr> <tr><td>7:</td><td>10.1</td><td>→</td></tr> <tr><td>8:</td><td>10.2</td><td>↘</td></tr> <tr><td>9:</td><td>10.6</td><td>↓</td></tr> </table>			1:	10.2	→	2:	10.5	→	3:	10.7x	↗	4:	9.8	↘	5:	10.3	↖	6:	10.5	↗	7:	10.1	→	8:	10.2	↘	9:	10.6	↓			
1:	10.2	→																																
2:	10.5	→																																
3:	10.7x	↗																																
4:	9.8	↘																																
5:	10.3	↖																																
6:	10.5	↗																																
7:	10.1	→																																
8:	10.2	↘																																
9:	10.6	↓																																
		Serie 89 (1x)																																
		Total 0 (0x)																																
20 Skud		<table border="0"> <tr><td>1:</td><td>10.7x</td><td>↘</td></tr> <tr><td>2:</td><td>10.2</td><td>↘</td></tr> <tr><td>3:</td><td>10.1</td><td>↘</td></tr> <tr><td>4:</td><td>10.7x</td><td>↓</td></tr> <tr><td>5:</td><td>10.5</td><td>↖</td></tr> <tr><td>6:</td><td>10.0</td><td>←</td></tr> <tr><td>7:</td><td>10.4</td><td>↗</td></tr> <tr><td>8:</td><td>10.8x</td><td>↗</td></tr> <tr><td>9:</td><td>10.2</td><td>↗</td></tr> <tr><td>10:</td><td>10.3</td><td>↘</td></tr> </table>			1:	10.7x	↘	2:	10.2	↘	3:	10.1	↘	4:	10.7x	↓	5:	10.5	↖	6:	10.0	←	7:	10.4	↗	8:	10.8x	↗	9:	10.2	↗	10:	10.3	↘
1:	10.7x	↘																																
2:	10.2	↘																																
3:	10.1	↘																																
4:	10.7x	↓																																
5:	10.5	↖																																
6:	10.0	←																																
7:	10.4	↗																																
8:	10.8x	↗																																
9:	10.2	↗																																
10:	10.3	↘																																
		Serie 100 (3x)																																
		Total 100 (3x)																																
20 Skud		<table border="0"> <tr><td>11:</td><td>10.3</td><td>↘</td></tr> <tr><td>12:</td><td>10.8x</td><td>↑</td></tr> <tr><td>13:</td><td>10.8x</td><td>↑</td></tr> <tr><td>14:</td><td>10.7x</td><td>↑</td></tr> <tr><td>15:</td><td>10.9x</td><td>↘</td></tr> <tr><td>16:</td><td>9.9</td><td>←</td></tr> <tr><td>17:</td><td>9.6</td><td>↑</td></tr> <tr><td>18:</td><td>9.7</td><td>←</td></tr> <tr><td>19:</td><td>10.7x</td><td>↗</td></tr> <tr><td>20:</td><td>10.5</td><td>←</td></tr> </table>			11:	10.3	↘	12:	10.8x	↑	13:	10.8x	↑	14:	10.7x	↑	15:	10.9x	↘	16:	9.9	←	17:	9.6	↑	18:	9.7	←	19:	10.7x	↗	20:	10.5	←
11:	10.3	↘																																
12:	10.8x	↑																																
13:	10.8x	↑																																
14:	10.7x	↑																																
15:	10.9x	↘																																
16:	9.9	←																																
17:	9.6	↑																																
18:	9.7	←																																
19:	10.7x	↗																																
20:	10.5	←																																
		Serie 97 (5x)																																
		Total 197 (8x)																																

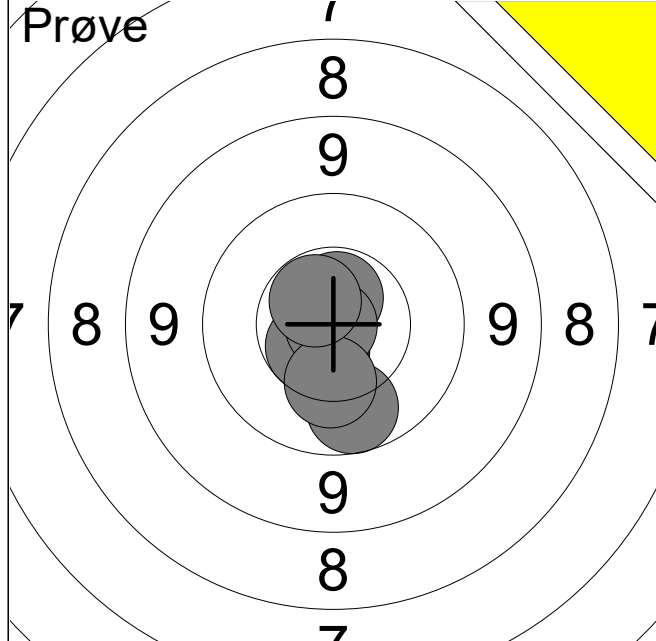

1:	9.9	↓
2:	10.8x	←
3:	10.6x	↓
4:	10.6	↓
5:	10.6x	↑
6:	10.6	←
7:	10.9x	←
8:	10.3	↓
9:	10.6x	↗
Serie		89 (5x)
Total		0 (0x)

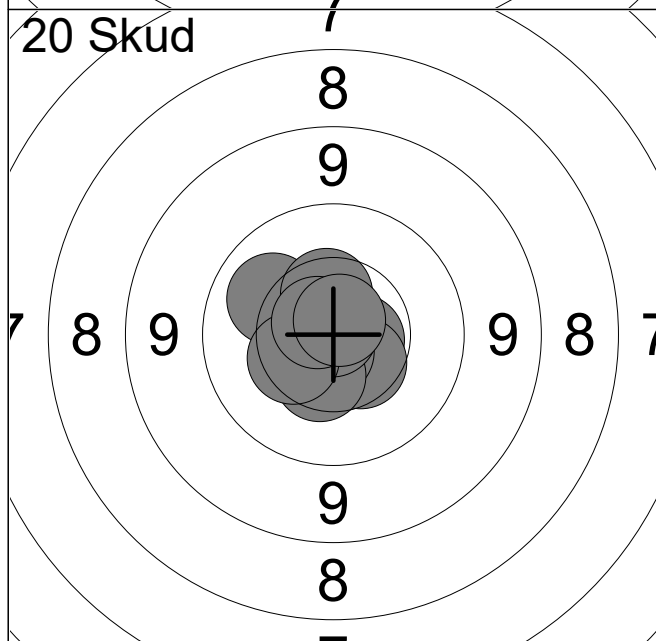

1:	10.6x	→
2:	10.5	↓
3:	10.7x	↓
4:	10.4	↓
5:	10.1	↖
6:	10.5	↑
7:	10.9x	↑
8:	10.4	←
9:	10.7x	↖
10:	10.8x	↑
Serie		100 (5x)
Total		100 (5x)

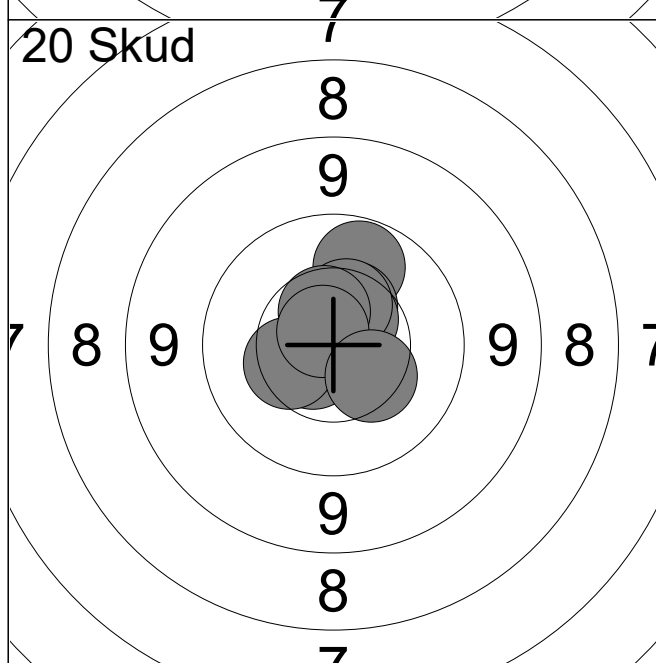

11:	10.6x	←
12:	10.0	↑
13:	10.4	←
14:	10.5	↗
15:	10.7x	↑
16:	10.6	↗
17:	10.5	↑
18:	10.5	↑
19:	10.7x	↗
20:	10.4	↓
Serie		100 (3x)
Total		200 (8x)

Hold 15	Skive 6	Jette Johansen		
ØSF		Frederikssund Skytteforening, I		MFR12
28.10.2024		Halloween Luftstævne 2024		Ølstykke skytteforening
Prøve		1: 10.7x ← 2: 10.0 →		
		Serie 20 (1x) Total 0 (0x)		
20 Skud		1: 10.1 ↓ 2: 9.5 ↑ 3: 9.4 → 4: 10.7x ↓ 5: 10.7x → 6: 10.9x ↓ 7: 10.3 ↑ 8: 10.5 → 9: 9.2 ↓ 10: 10.6x ←		
		Serie 97 (4x) Total 97 (4x)		
20 Skud		11: 9.9 → 12: 10.0 ↓ 13: 10.2 → 14: 9.8 ↗ 15: 8.4 ↗ 16: 10.7x ↑ 17: 10.4 ← 18: 10.5 ↓ 19: 10.5 ← 20: 10.5 ↗		
		Serie 96 (1x) Total 193 (5x)		

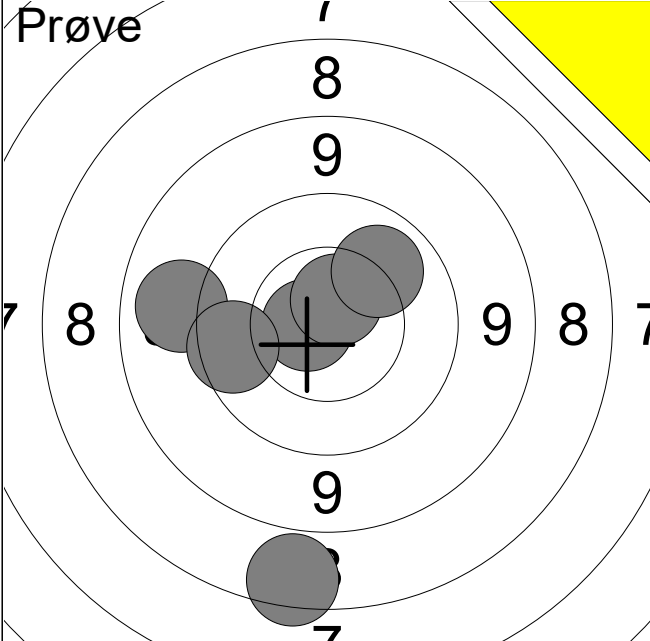
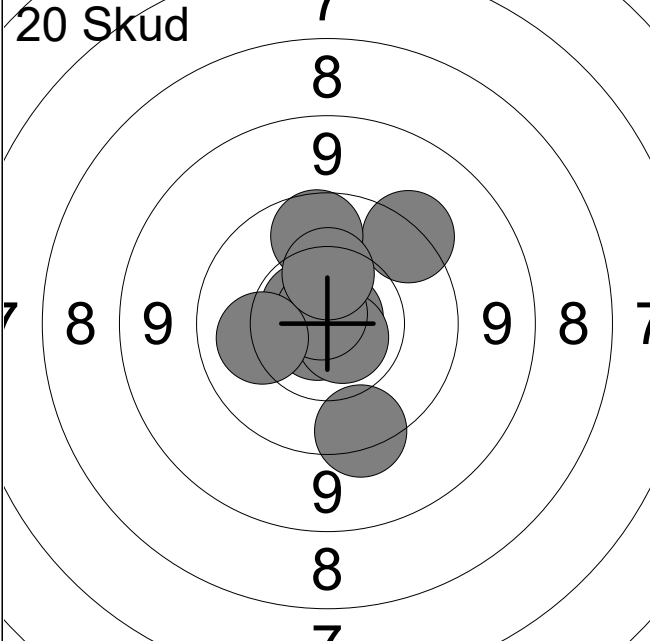
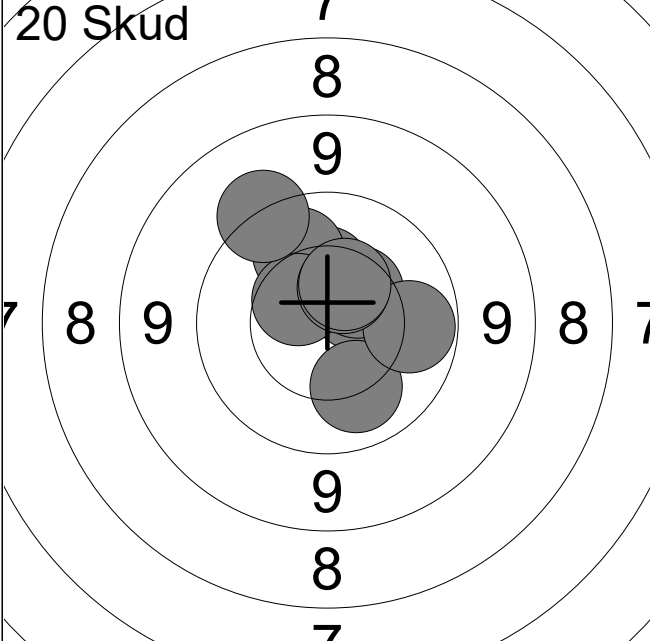
Hold 15	Skive 7	Hans Henrik Johansen																																
ØSF		Frederikssund Skytteforening, I		MFR11																														
28.10.2024		Halloween Luftstævne 2024		Ølstykke skytteforening																														
Prøve		<table border="0"> <tr><td>1:</td><td>7.7</td><td>↓</td></tr> <tr><td>2:</td><td>9.1</td><td>←</td></tr> <tr><td>3:</td><td>10.7x</td><td>←</td></tr> <tr><td>4:</td><td>9.8</td><td>←</td></tr> <tr><td>5:</td><td>10.6x</td><td>↑</td></tr> <tr><td>6:</td><td>10.1</td><td>↗</td></tr> </table>			1:	7.7	↓	2:	9.1	←	3:	10.7x	←	4:	9.8	←	5:	10.6x	↑	6:	10.1	↗												
1:	7.7	↓																																
2:	9.1	←																																
3:	10.7x	←																																
4:	9.8	←																																
5:	10.6x	↑																																
6:	10.1	↗																																
		<table border="0"> <tr><td>Serie</td><td colspan="3">55 (2x)</td></tr> <tr><td>Total</td><td colspan="3">0 (0x)</td></tr> </table>			Serie	55 (2x)			Total	0 (0x)																								
Serie	55 (2x)																																	
Total	0 (0x)																																	
20 Skud		<table border="0"> <tr><td>1:</td><td>9.6</td><td>↓</td></tr> <tr><td>2:</td><td>9.5</td><td>↗</td></tr> <tr><td>3:</td><td>10.8x</td><td>↓</td></tr> <tr><td>4:</td><td>10.8x</td><td>↗</td></tr> <tr><td>5:</td><td>10.7x</td><td>↓</td></tr> <tr><td>6:</td><td>10.6x</td><td>↗</td></tr> <tr><td>7:</td><td>10.8x</td><td>↗</td></tr> <tr><td>8:</td><td>9.9</td><td>↑</td></tr> <tr><td>9:</td><td>10.2</td><td>←</td></tr> <tr><td>10:</td><td>10.4</td><td>↑</td></tr> </table>			1:	9.6	↓	2:	9.5	↗	3:	10.8x	↓	4:	10.8x	↗	5:	10.7x	↓	6:	10.6x	↗	7:	10.8x	↗	8:	9.9	↑	9:	10.2	←	10:	10.4	↑
1:	9.6	↓																																
2:	9.5	↗																																
3:	10.8x	↓																																
4:	10.8x	↗																																
5:	10.7x	↓																																
6:	10.6x	↗																																
7:	10.8x	↗																																
8:	9.9	↑																																
9:	10.2	←																																
10:	10.4	↑																																
		<table border="0"> <tr><td>Serie</td><td colspan="3">97 (5x)</td></tr> <tr><td>Total</td><td colspan="3">97 (5x)</td></tr> </table>			Serie	97 (5x)			Total	97 (5x)																								
Serie	97 (5x)																																	
Total	97 (5x)																																	
20 Skud		<table border="0"> <tr><td>11:</td><td>10.3</td><td>↑</td></tr> <tr><td>12:</td><td>10.5</td><td>↗</td></tr> <tr><td>13:</td><td>10.1</td><td>↑</td></tr> <tr><td>14:</td><td>10.1</td><td>↓</td></tr> <tr><td>15:</td><td>10.5</td><td>↗</td></tr> <tr><td>16:</td><td>10.4</td><td>↗</td></tr> <tr><td>17:</td><td>9.4</td><td>↑</td></tr> <tr><td>18:</td><td>10.0</td><td>→</td></tr> <tr><td>19:</td><td>10.5</td><td>↑</td></tr> <tr><td>20:</td><td>10.5</td><td>↑</td></tr> </table>			11:	10.3	↑	12:	10.5	↗	13:	10.1	↑	14:	10.1	↓	15:	10.5	↗	16:	10.4	↗	17:	9.4	↑	18:	10.0	→	19:	10.5	↑	20:	10.5	↑
11:	10.3	↑																																
12:	10.5	↗																																
13:	10.1	↑																																
14:	10.1	↓																																
15:	10.5	↗																																
16:	10.4	↗																																
17:	9.4	↑																																
18:	10.0	→																																
19:	10.5	↑																																
20:	10.5	↑																																
		<table border="0"> <tr><td>Serie</td><td colspan="3">99 (0x)</td></tr> <tr><td>Total</td><td colspan="3">196 (5x)</td></tr> </table>			Serie	99 (0x)			Total	196 (5x)																								
Serie	99 (0x)																																	
Total	196 (5x)																																	

Hold	Skive	Michael Pedersen		
15	8	ØSF	Frederikssund Skytteforening, I	MSE2
28.10.2024	Halloween Luftstævne 2024	Ølstykke skytteforening		
Prøve		1:	8.0	↖
		2:	10.7x	↑
		3:	9.1	←
		4:	8.5	←
		5:	10.0	↗
		6:	10.4	↗
Serie		55 (1x)		
Total		0 (0x)		
20 Skud		1:	9.2	→
		2:	10.2	↘
		3:	10.1	↗
		4:	10.4	↘
		5:	10.0	↗
		6:	8.9	↗
		7:	10.1	↗
		8:	10.7x	↗
		9:	9.7	↘
		10:	10.4	→
Serie		96 (1x)		
Total		96 (1x)		
20 Skud		11:	10.2	↗
		12:	9.3	↗
		13:	10.6	↘
		14:	10.3	↗
		15:	9.4	↘
		16:	10.1	↘
		17:	8.2	↗
		18:	9.2	↗
		19:	10.1	→
		20:	9.7	←
Serie		94 (0x)		
Total		190 (1x)		

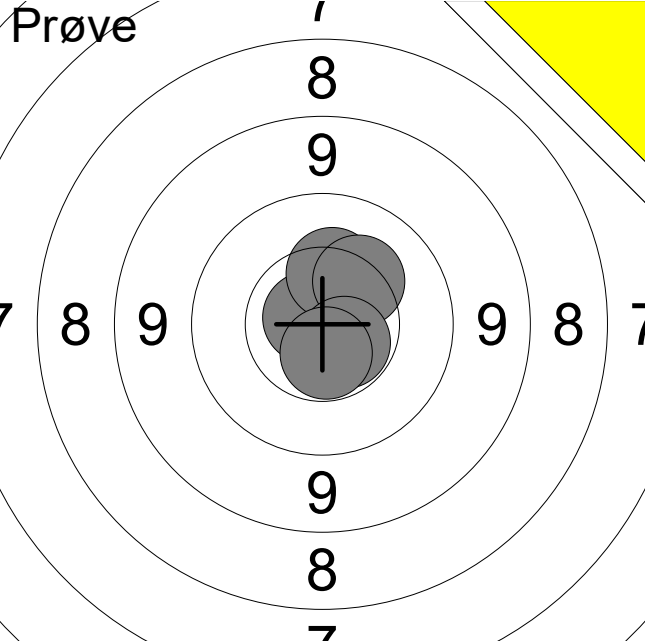
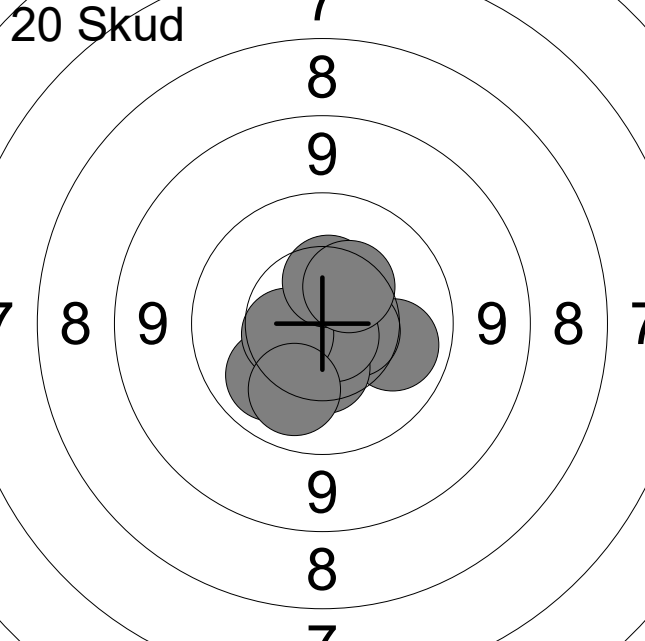
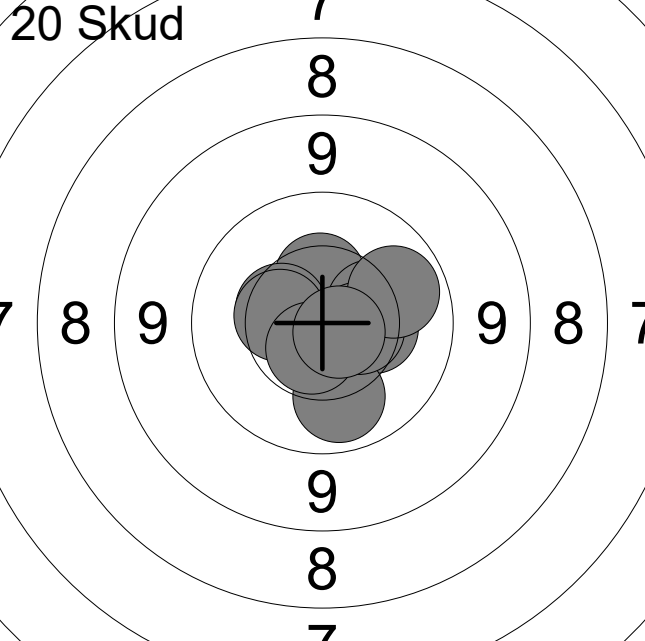
Hold 15	Skive 9	Lea Linda Bejning Andersen		
ØSF		Ølstykke Skytteforening		MÅ1
28.10.2024		Halloween Luftstævne 2024		Ølstykke skytteforening
Prøve		1: 10.8x ↖ 2: 10.3 ↑ 3: 10.3 ↗ 4: 10.6x ↘ 5: 10.6x ↓		
		Serie 50 (3x)		
		Total 0 (0x)		
20 Skud		1: 10.1 → 2: 10.6 → 3: 10.4 ↓ 4: 10.1 ↙ 5: 10.6x ↙ 6: 10.8x ↘ 7: 10.5 ← 8: 10.1 ↓ 9: 10.4 ↑ 10: 10.4 ↗		
		Serie 100 (2x)		
		Total 100 (2x)		
20 Skud		11: 10.4 ↑ 12: 10.4 ← 13: 10.3 → 14: 10.4 → 15: 10.4 ← 16: 10.1 ↓ 17: 10.5 → 18: 10.6x ↓ 19: 10.0 ↗ 20: 10.7x ↘		
		Serie 100 (2x)		
		Total 200 (4x)		

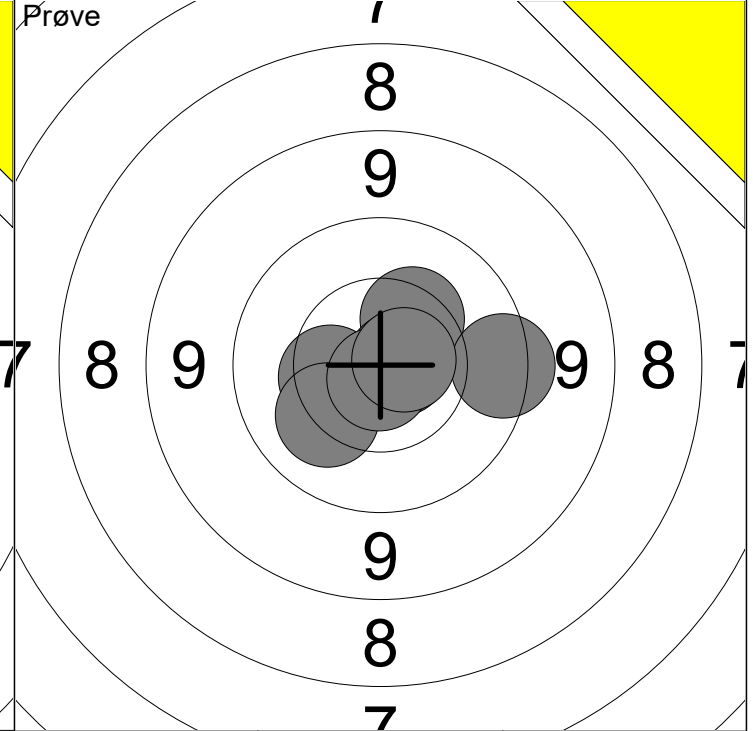
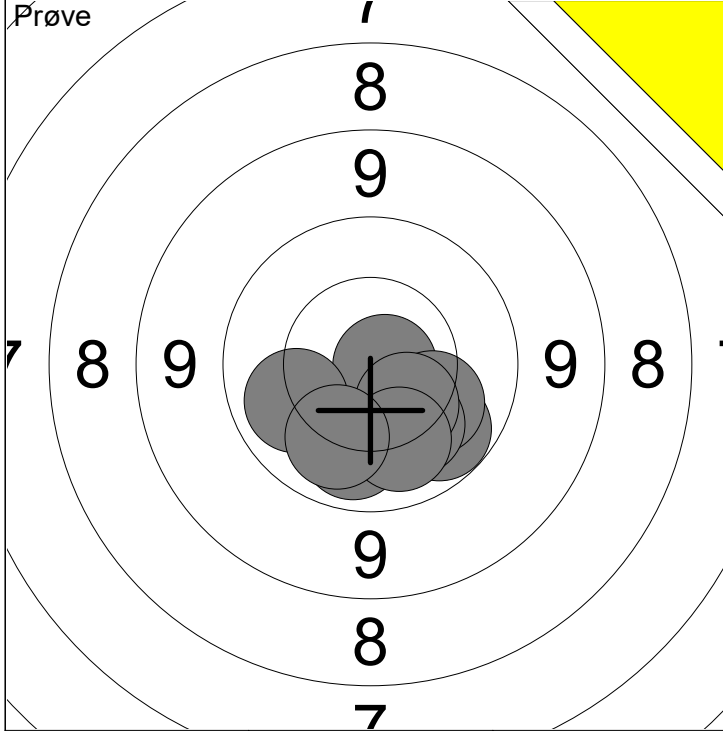

1: 10.5 ↘	6: 10.2 ↘	Serie 100 (1x)
2: 10.8x →	7: 10.4 ↘	
3: 10.0 ↘	8: 10.1 ↘	Total 0 (0x)
4: 10.2 ↘	9: 10.1 ←	
5: 10.1 ↘	10: 10.1 ↘	

11: 10.4 ↗	16: 10.8x ↘	Serie 69 (3x)
12: 10.4 ←	17: 10.7x →	
13: 10.2 ↘	14: 10.8x →	Total 0 (0x)
15: 9.6 →		

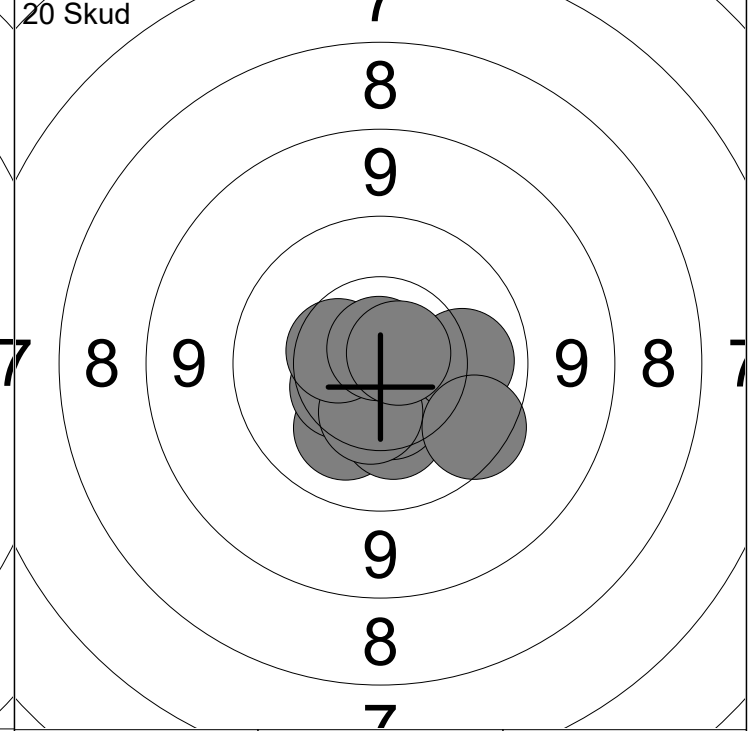
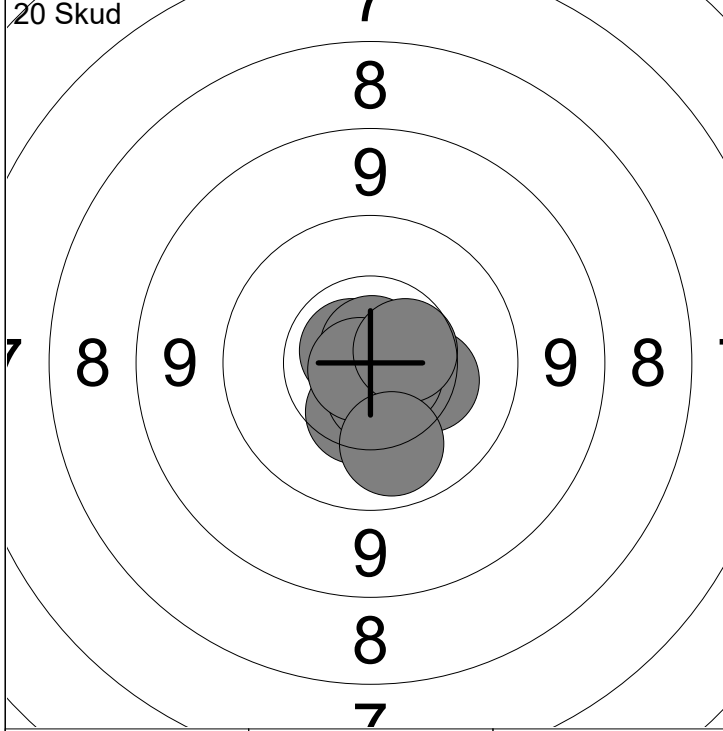

1: 10.4 ↘	6: 10.6x ↘	Serie 100 (6x)
2: 10.3 →	7: 10.7x ↘	
3: 10.8x ↗	8: 10.8x ←	Total 100 (6x)
4: 10.7x ↖	9: 10.6 →	
5: 10.8x ↗	10: 10.1 ↘	

11: 10.2 ↘	16: 10.4 ↘	Serie 99 (2x)
12: 10.3 ↘	17: 10.5 ←	
13: 10.5 ↖	18: 10.8x ↗	Total 199 (8x)
14: 10.5 ↘	19: 10.7x ↗	
15: 10.1 →	20: 9.7 ↘	

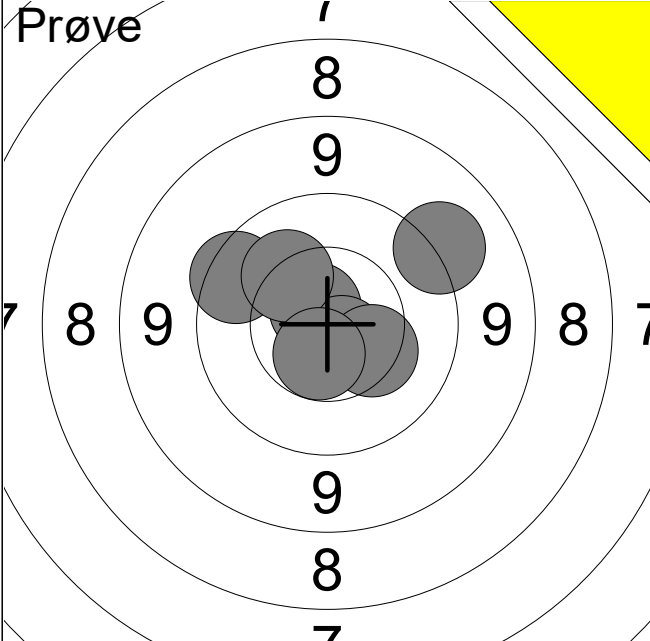
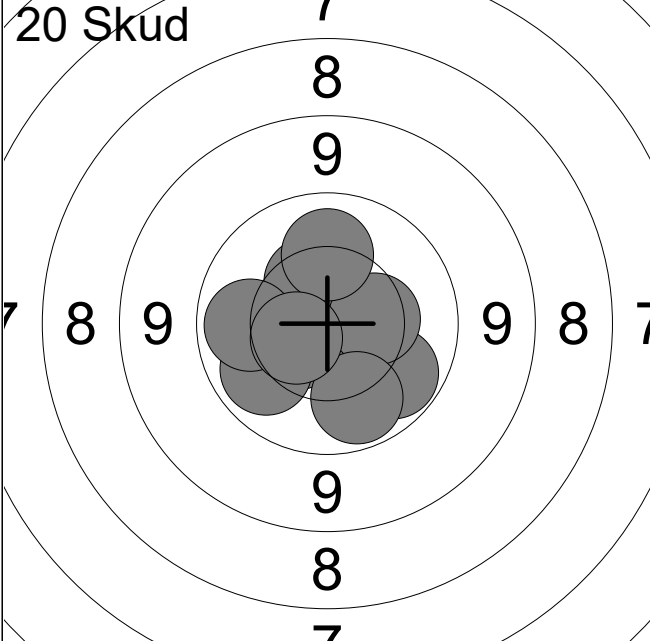
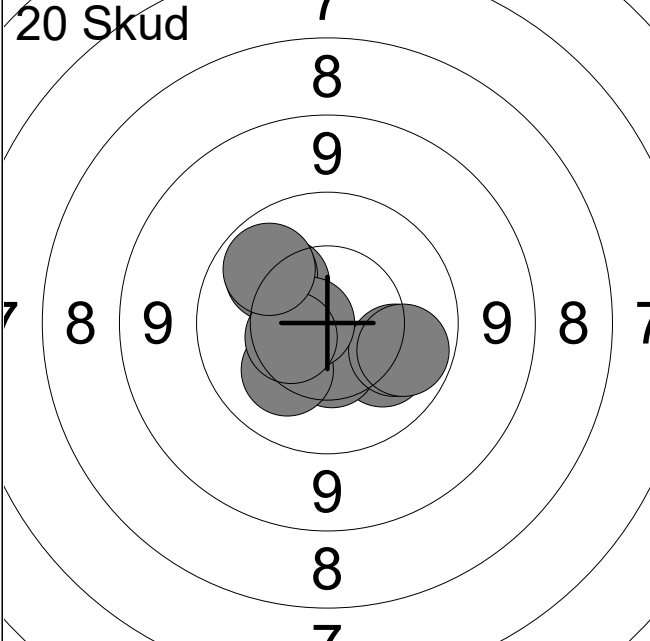
Hold 16	Skive 4	Stine Kongsted																																
ØSF		Frederikssund Skytteforening, I		MÅ1																														
28.10.2024		Halloween Luftstævne 2024		Ølstykke skytteforening																														
Prøve		<table border="0"> <tr><td>1:</td><td>9.7</td><td>↖</td></tr> <tr><td>2:</td><td>10.7x</td><td>↗</td></tr> <tr><td>3:</td><td>10.7x</td><td>↘</td></tr> <tr><td>4:</td><td>10.3</td><td>↘</td></tr> <tr><td>5:</td><td>9.3</td><td>↗</td></tr> <tr><td>6:</td><td>10.2</td><td>↗</td></tr> <tr><td>7:</td><td>10.6</td><td>↘</td></tr> </table>			1:	9.7	↖	2:	10.7x	↗	3:	10.7x	↘	4:	10.3	↘	5:	9.3	↗	6:	10.2	↗	7:	10.6	↘									
1:	9.7	↖																																
2:	10.7x	↗																																
3:	10.7x	↘																																
4:	10.3	↘																																
5:	9.3	↗																																
6:	10.2	↗																																
7:	10.6	↘																																
		Serie 68 (2x)																																
		Total 0 (0x)																																
20 Skud		<table border="0"> <tr><td>1:</td><td>10.5</td><td>↘</td></tr> <tr><td>2:</td><td>10.5</td><td>↖</td></tr> <tr><td>3:</td><td>10.4</td><td>↗</td></tr> <tr><td>4:</td><td>10.0</td><td>↘</td></tr> <tr><td>5:</td><td>10.0</td><td>↖</td></tr> <tr><td>6:</td><td>10.4</td><td>→</td></tr> <tr><td>7:</td><td>10.1</td><td>↑</td></tr> <tr><td>8:</td><td>10.0</td><td>↘</td></tr> <tr><td>9:</td><td>10.0</td><td>←</td></tr> <tr><td>10:</td><td>10.5</td><td>↖</td></tr> </table>			1:	10.5	↘	2:	10.5	↖	3:	10.4	↗	4:	10.0	↘	5:	10.0	↖	6:	10.4	→	7:	10.1	↑	8:	10.0	↘	9:	10.0	←	10:	10.5	↖
1:	10.5	↘																																
2:	10.5	↖																																
3:	10.4	↗																																
4:	10.0	↘																																
5:	10.0	↖																																
6:	10.4	→																																
7:	10.1	↑																																
8:	10.0	↘																																
9:	10.0	←																																
10:	10.5	↖																																
		Serie 100 (0x)																																
		Total 100 (0x)																																
20 Skud		<table border="0"> <tr><td>11:</td><td>10.2</td><td>↘</td></tr> <tr><td>12:</td><td>10.5</td><td>↘</td></tr> <tr><td>13:</td><td>10.1</td><td>↘</td></tr> <tr><td>14:</td><td>10.0</td><td>↘</td></tr> <tr><td>15:</td><td>10.3</td><td>↗</td></tr> <tr><td>16:</td><td>10.2</td><td>↘</td></tr> <tr><td>17:</td><td>10.1</td><td>↗</td></tr> <tr><td>18:</td><td>10.7x</td><td>←</td></tr> <tr><td>19:</td><td>10.5</td><td>↖</td></tr> <tr><td>20:</td><td>10.0</td><td>↗</td></tr> </table>			11:	10.2	↘	12:	10.5	↘	13:	10.1	↘	14:	10.0	↘	15:	10.3	↗	16:	10.2	↘	17:	10.1	↗	18:	10.7x	←	19:	10.5	↖	20:	10.0	↗
11:	10.2	↘																																
12:	10.5	↘																																
13:	10.1	↘																																
14:	10.0	↘																																
15:	10.3	↗																																
16:	10.2	↘																																
17:	10.1	↗																																
18:	10.7x	←																																
19:	10.5	↖																																
20:	10.0	↗																																
		Serie 100 (1x)																																
		Total 200 (1x)																																

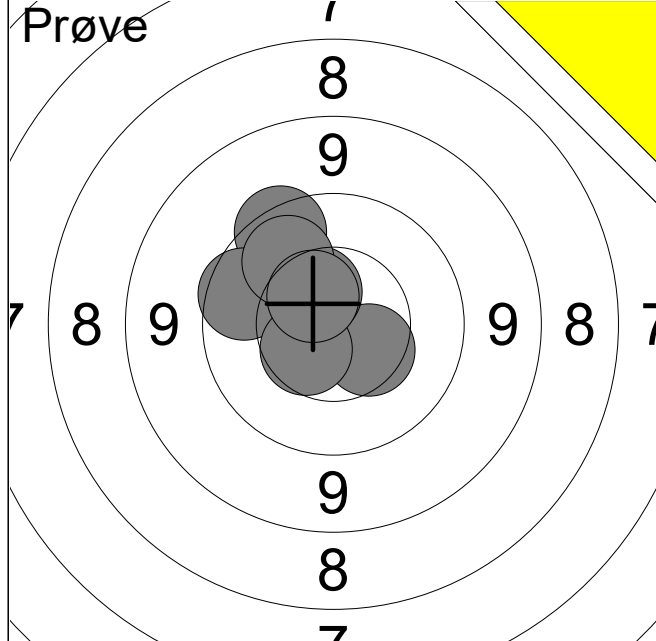

1:	9.7	↗
2:	10.4	↘
3:	10.5	↗
4:	9.8	↖
5:	10.0	↗
6:	10.5	↙
7:	10.5	↗
Serie		68 (0x)
Total		0 (0x)

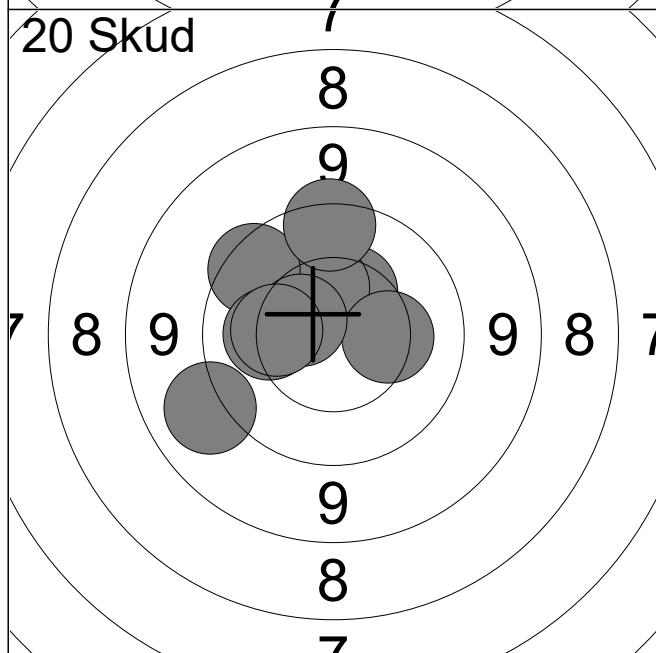

1:	10.2	↑
2:	10.4	↗
3:	10.4	↑
4:	9.2	↖
5:	9.7	↗
6:	10.3	→
7:	9.6	↑
8:	10.5	↖
9:	10.2	←
10:	10.3	←
Serie		97 (0x)
Total		97 (0x)

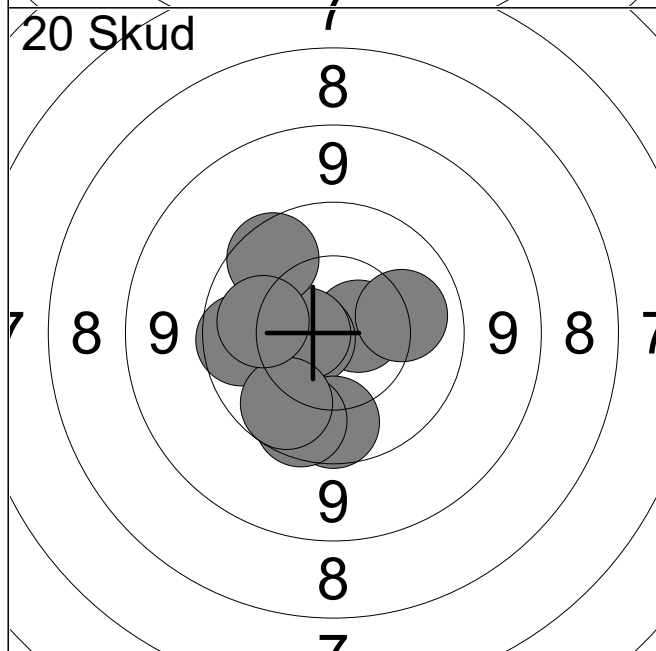

11:	10.6x	→
12:	10.7x	←
13:	9.9	↓
14:	10.1	→
15:	10.6x	←
16:	9.8	↘
17:	9.9	←
18:	9.8	↗
19:	10.0	↘
20:	10.1	←
Serie		96 (3x)
Total		193 (3x)

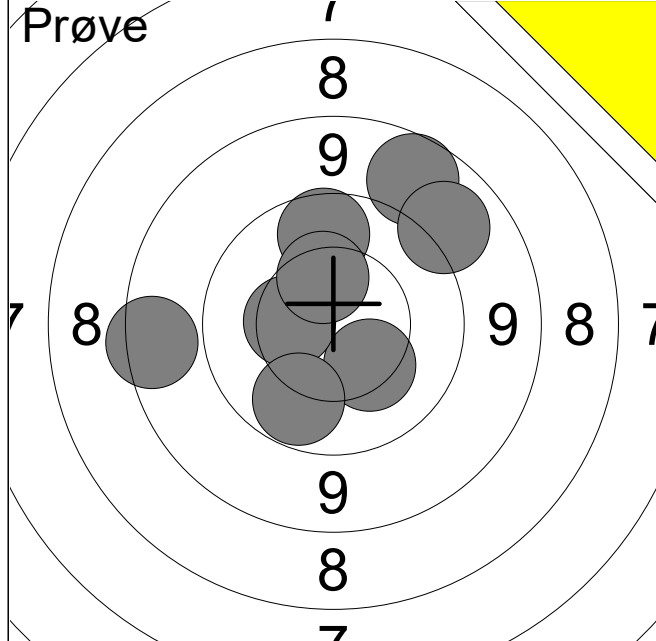

1:	8.9	↗
2:	9.1	↘
3:	9.9	↑
4:	10.3	↘
5:	10.4	←
6:	10.0	↘
7:	8.7	←
8:	10.4	↑
Serie		74 (0x)
Total		0 (0x)

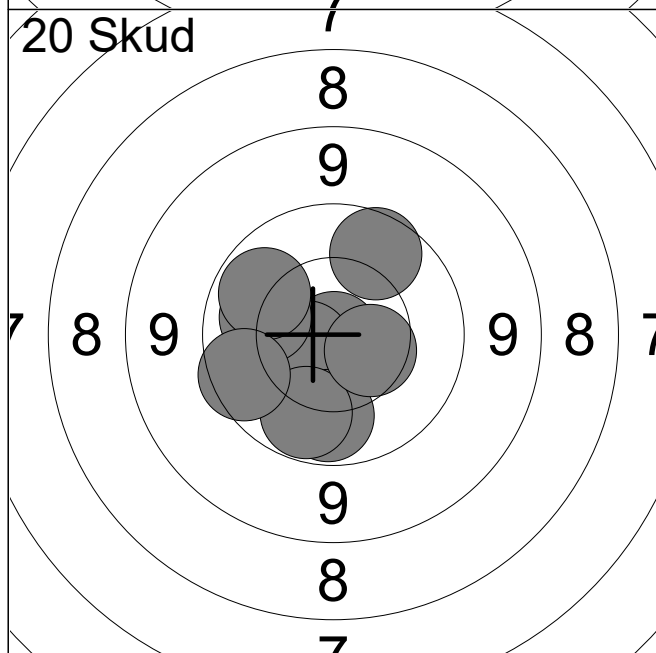

1:	9.9	↗
2:	10.9x	↘
3:	10.4	←
4:	10.6x	←
5:	10.1	←
6:	10.0	↘
7:	10.0	↘
8:	10.0	↖
9:	9.8	←
10:	10.5	→
Serie		98 (2x)
Total		98 (2x)

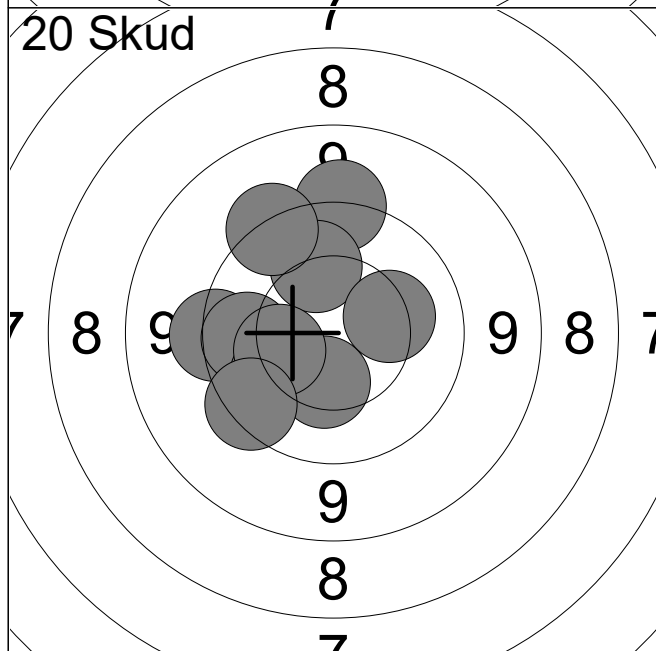

11:	9.4	↑
12:	9.5	←
13:	10.1	↑
14:	9.9	←
15:	10.1	↘
16:	9.5	↗
17:	10.4	↘
18:	10.3	←
19:	9.6	↘
20:	10.3	→
Serie		95 (0x)
Total		193 (2x)

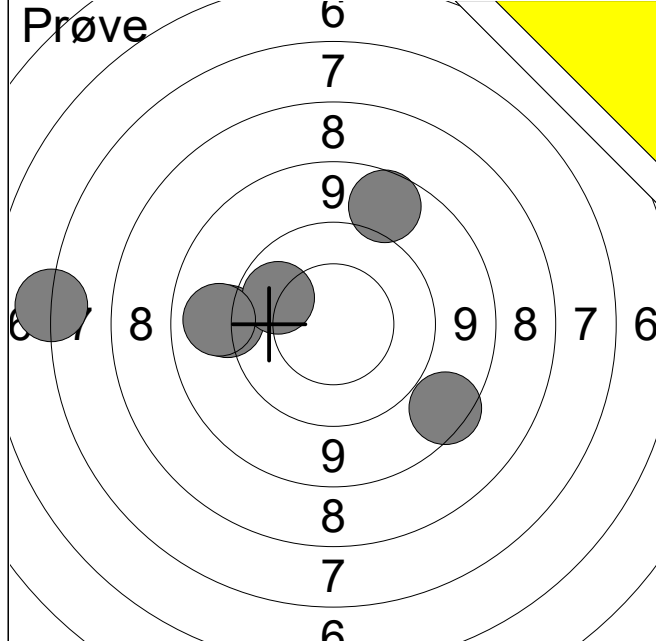

1:	6.3	←
2:	8.9	↑
3:	9.3	←
4:	10.0	↖
5:	9.1	←
6:	8.7	↘
Serie		50 (0x)
Total		0 (0x)

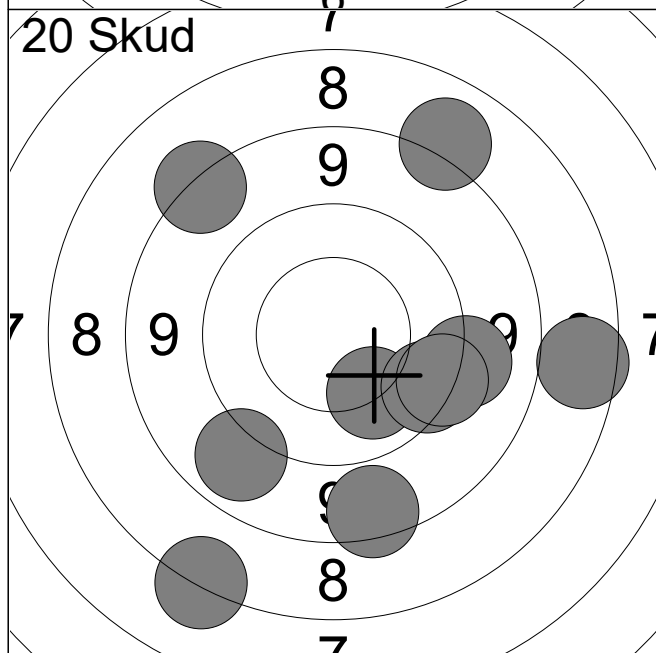

1:	9.1	↙
2:	8.7	↘
3:	10.1	↘
4:	7.4	↘
5:	9.3	→
6:	8.2	↗
7:	7.8	→
8:	8.5	↗
9:	9.7	↘
10:	9.5	↘
Serie		84 (0x)
Total		84 (0x)

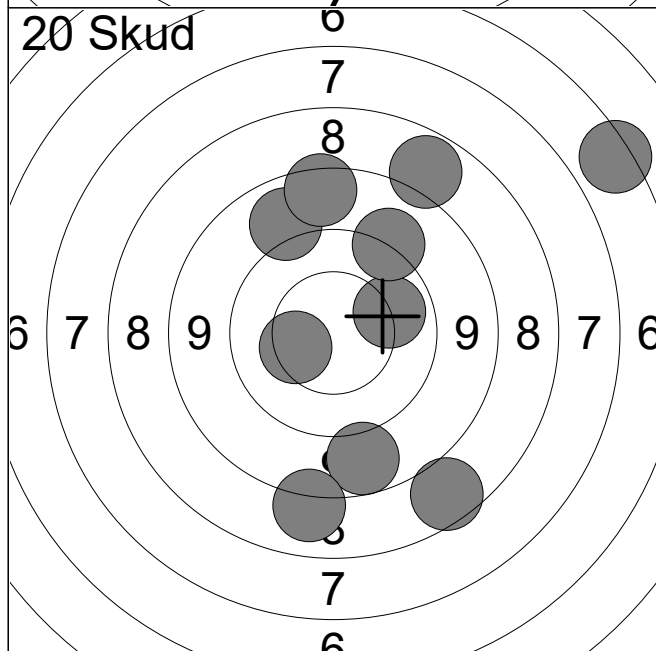

11:	8.9	↘
12:	8.0	↗
13:	9.1	↗
14:	10.1	→
15:	10.4	←
16:	5.6	↗
17:	9.3	↗
18:	8.7	↑
19:	7.8	↘
20:	8.2	↘
Serie		82 (0x)
Total		166 (0x)

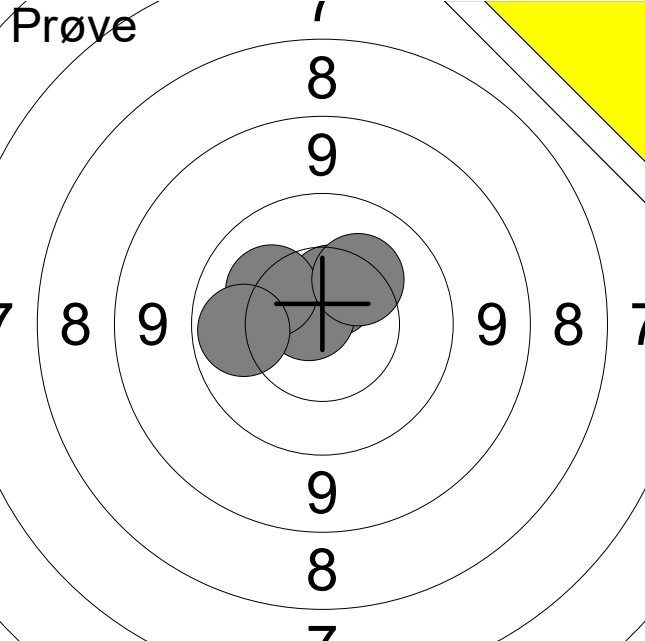
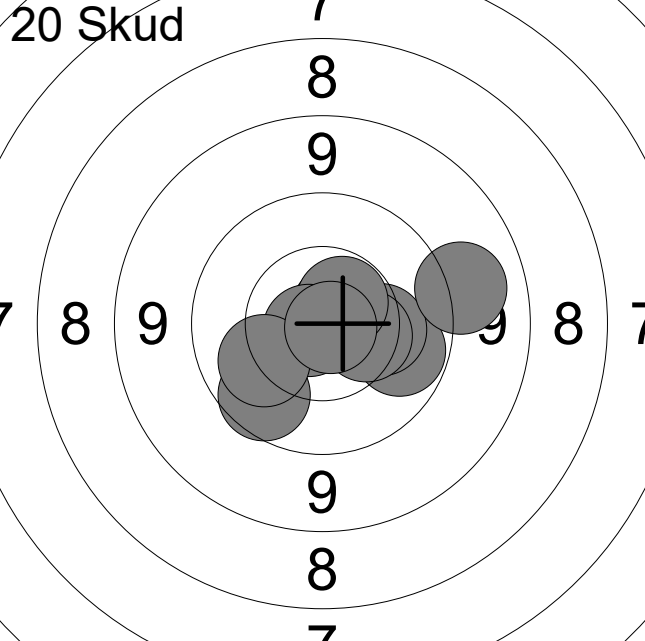
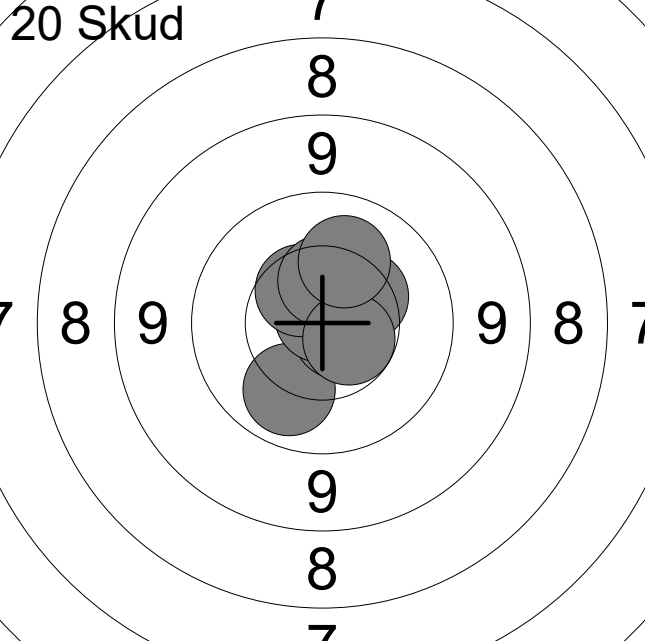
Hold 19	Skive 2	Selma Theilade																																
ØSF		Skyttelaugget Kgs. Lyngby		J1																														
28.10.2024		Halloween Luftstævne 2024		Ølstykke skytteforening																														
Prøve		<table border="0"> <tr><td>1:</td><td>10.6x</td><td>↖</td></tr> <tr><td>2:</td><td>10.5</td><td>↑</td></tr> <tr><td>3:</td><td>10.7x</td><td>↗</td></tr> <tr><td>4:</td><td>10.2</td><td>↗</td></tr> <tr><td>5:</td><td>10.0</td><td>←</td></tr> <tr><td>6:</td><td>10.3</td><td>↗</td></tr> </table>			1:	10.6x	↖	2:	10.5	↑	3:	10.7x	↗	4:	10.2	↗	5:	10.0	←	6:	10.3	↗												
1:	10.6x	↖																																
2:	10.5	↑																																
3:	10.7x	↗																																
4:	10.2	↗																																
5:	10.0	←																																
6:	10.3	↗																																
		<table border="0"> <tr><td>Serie</td><td colspan="3">60 (2x)</td></tr> <tr><td>Total</td><td colspan="3">0 (0x)</td></tr> </table>			Serie	60 (2x)			Total	0 (0x)																								
Serie	60 (2x)																																	
Total	0 (0x)																																	
20 Skud		<table border="0"> <tr><td>1:</td><td>10.7x</td><td>↗</td></tr> <tr><td>2:</td><td>10.0</td><td>→</td></tr> <tr><td>3:</td><td>9.9</td><td>↘</td></tr> <tr><td>4:</td><td>10.3</td><td>→</td></tr> <tr><td>5:</td><td>9.2</td><td>→</td></tr> <tr><td>6:</td><td>10.4</td><td>→</td></tr> <tr><td>7:</td><td>10.6x</td><td>↗</td></tr> <tr><td>8:</td><td>10.8x</td><td>←</td></tr> <tr><td>9:</td><td>10.1</td><td>←</td></tr> <tr><td>10:</td><td>10.8x</td><td>→</td></tr> </table>			1:	10.7x	↗	2:	10.0	→	3:	9.9	↘	4:	10.3	→	5:	9.2	→	6:	10.4	→	7:	10.6x	↗	8:	10.8x	←	9:	10.1	←	10:	10.8x	→
1:	10.7x	↗																																
2:	10.0	→																																
3:	9.9	↘																																
4:	10.3	→																																
5:	9.2	→																																
6:	10.4	→																																
7:	10.6x	↗																																
8:	10.8x	←																																
9:	10.1	←																																
10:	10.8x	→																																
		<table border="0"> <tr><td>Serie</td><td colspan="3">98 (4x)</td></tr> <tr><td>Total</td><td colspan="3">98 (4x)</td></tr> </table>			Serie	98 (4x)			Total	98 (4x)																								
Serie	98 (4x)																																	
Total	98 (4x)																																	
20 Skud		<table border="0"> <tr><td>11:</td><td>10.1</td><td>↘</td></tr> <tr><td>12:</td><td>10.7x</td><td>↘</td></tr> <tr><td>13:</td><td>10.6</td><td>↗</td></tr> <tr><td>14:</td><td>10.8x</td><td>↑</td></tr> <tr><td>15:</td><td>10.9x</td><td>↑</td></tr> <tr><td>16:</td><td>10.5</td><td>↗</td></tr> <tr><td>17:</td><td>10.4</td><td>↗</td></tr> <tr><td>18:</td><td>10.5</td><td>↑</td></tr> <tr><td>19:</td><td>10.6</td><td>↘</td></tr> <tr><td>20:</td><td>10.2</td><td>↑</td></tr> </table>			11:	10.1	↘	12:	10.7x	↘	13:	10.6	↗	14:	10.8x	↑	15:	10.9x	↑	16:	10.5	↗	17:	10.4	↗	18:	10.5	↑	19:	10.6	↘	20:	10.2	↑
11:	10.1	↘																																
12:	10.7x	↘																																
13:	10.6	↗																																
14:	10.8x	↑																																
15:	10.9x	↑																																
16:	10.5	↗																																
17:	10.4	↗																																
18:	10.5	↑																																
19:	10.6	↘																																
20:	10.2	↑																																
		<table border="0"> <tr><td>Serie</td><td colspan="3">100 (3x)</td></tr> <tr><td>Total</td><td colspan="3">198 (7x)</td></tr> </table>			Serie	100 (3x)			Total	198 (7x)																								
Serie	100 (3x)																																	
Total	198 (7x)																																	

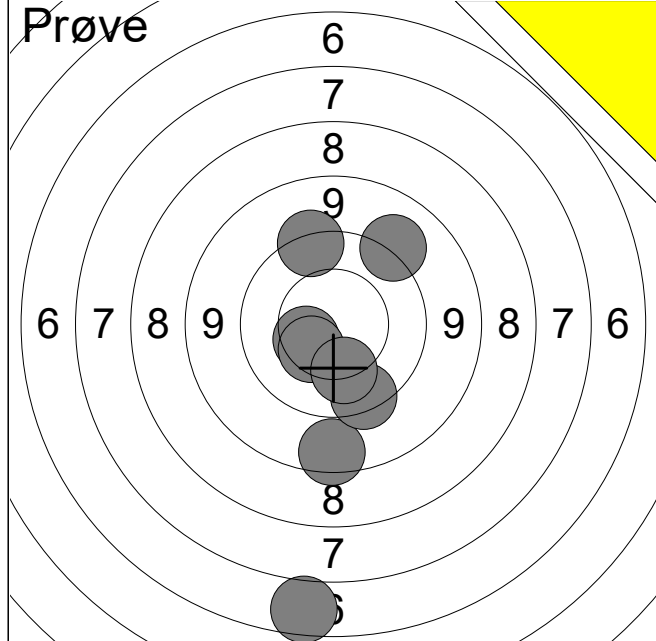

1:	9.3	↗
2:	9.5	↑
3:	8.7	↓
4:	5.8	↓
5:	10.4	↖
6:	9.6	↓
7:	10.4	↖
8:	10.2	↓
Serie		70 (0x)
Total		0 (0x)

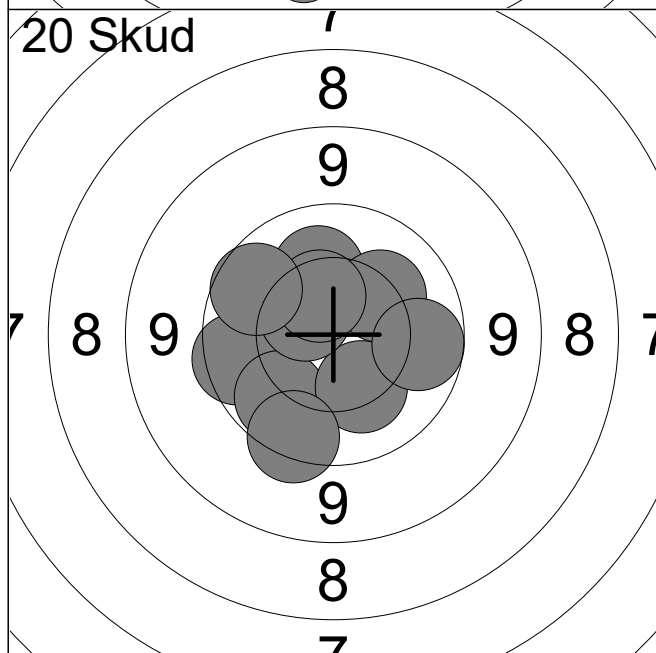

1:	9.8	↖
2:	10.2	↑
3:	10.0	↘
4:	10.3	↓
5:	10.5	↗
6:	10.2	↗
7:	9.6	↓
8:	10.5	↑
9:	9.9	→
10:	9.9	↖
Serie		96 (0x)
Total		96 (0x)

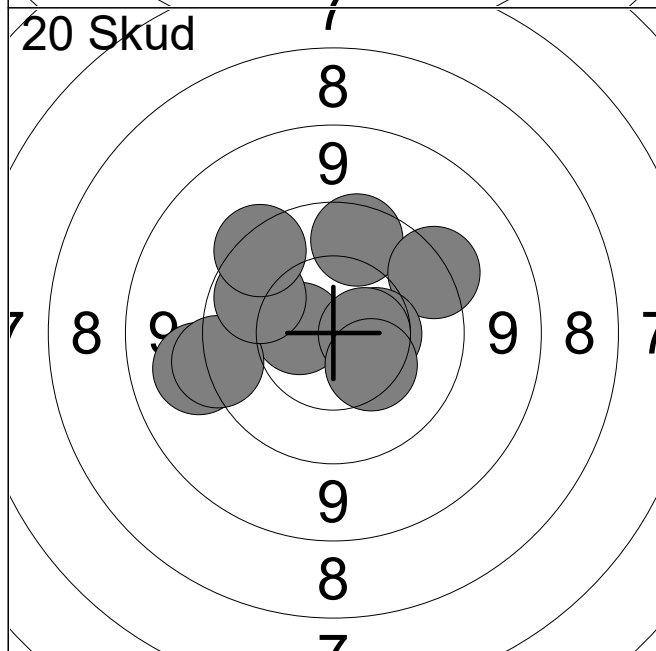

11:	9.8	↑
12:	9.2	↖
13:	10.5	↖
14:	9.5	↗
15:	9.5	↖
16:	10.0	↖
17:	10.4	→
18:	9.6	↗
19:	10.6	→
20:	10.4	↘
Serie		95 (0x)
Total		191 (0x)

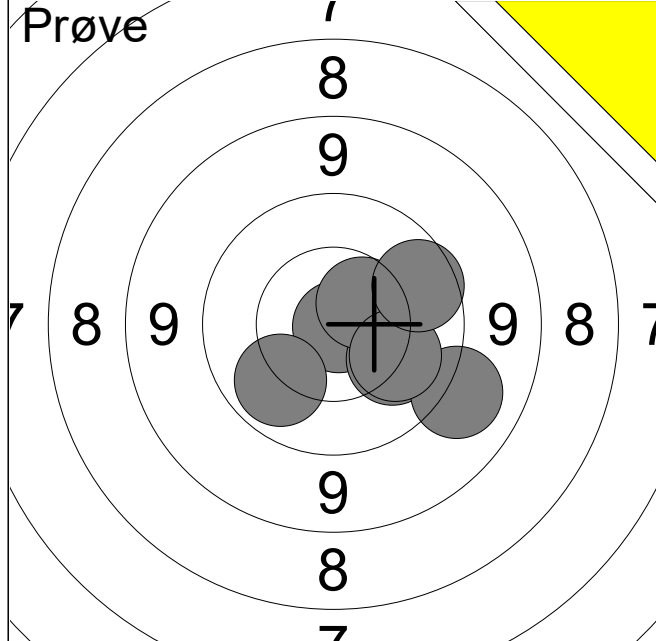

1:	10.9x	→
2:	10.1	↘
3:	10.5	↗
4:	9.2	↘
5:	10.1	↘
6:	9.8	↗
7:	10.0	↙
Serie		68 (1x)
Total		0 (0x)

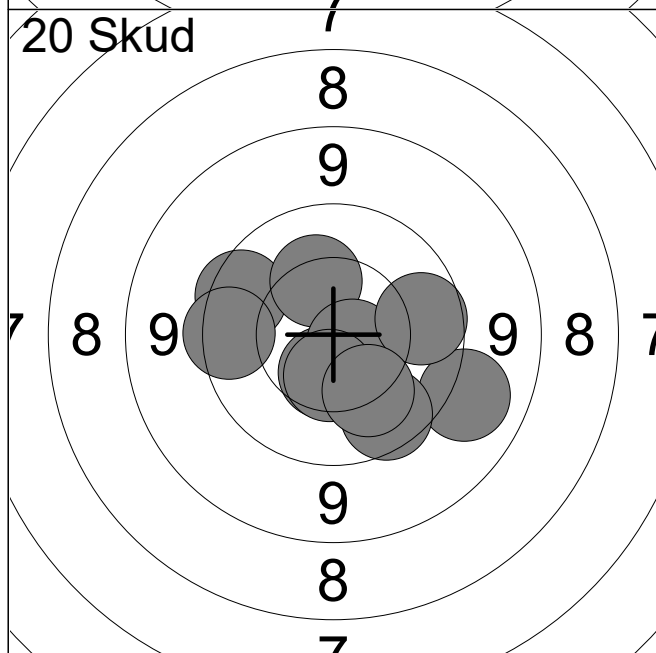

1:	9.7	↖
2:	9.2	↘
3:	9.7	↖
4:	10.5	↘
5:	10.3	↗
6:	9.8	↘
7:	10.7x	↘
8:	10.5	↘
9:	9.9	→
10:	10.2	↘
Serie		95 (1x)
Total		95 (1x)

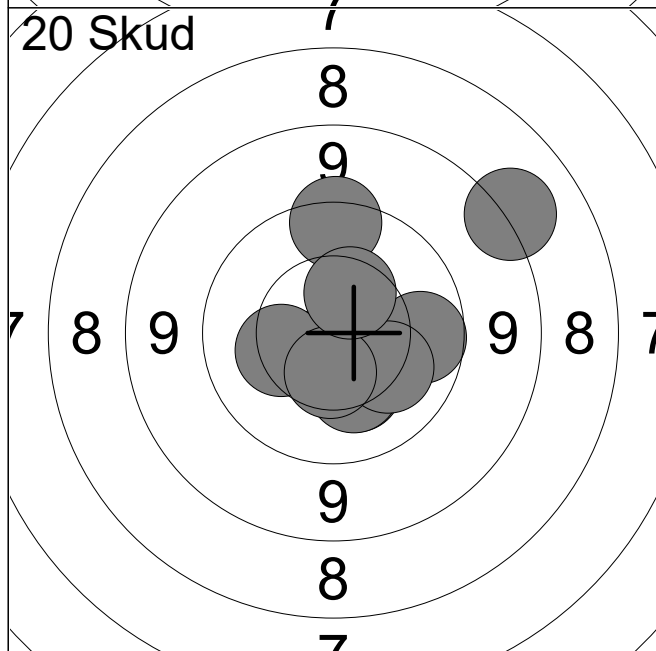

11:	9.6	↑
12:	10.8x	↘
13:	10.3	↘
14:	9.9	→
15:	10.3	↘
16:	10.3	↖
17:	10.2	↘
18:	8.3	↗
19:	10.5	↘
20:	10.4	↗
Serie		96 (1x)
Total		191 (2x)

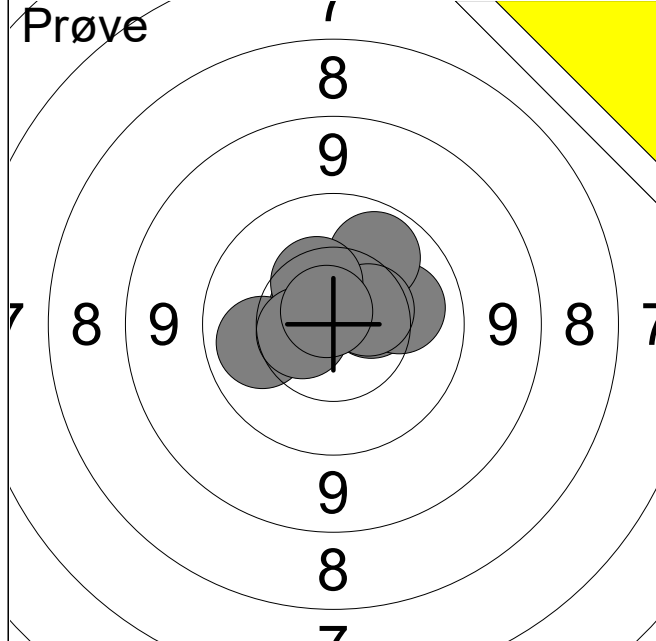

1:	10.5	→
2:	10.4	↑
3:	10.2	→
4:	10.0	↑
5:	10.7x	↖
6:	10.5	→
7:	10.1	←
8:	10.4	↑
9:	10.6	←
10:	10.8x	↑
Serie		100 (2x)
Total		0 (0x)

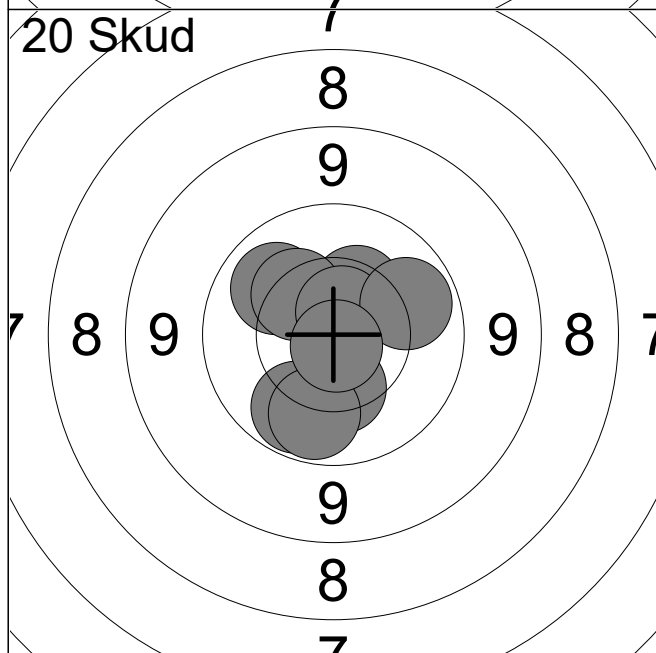

1:	10.0	↓
2:	10.7x	↑
3:	10.3	↓
4:	10.1	↖
5:	10.4	↑
6:	10.3	↖
7:	10.7x	↑
8:	10.0	↓
9:	10.0	→
10:	10.8x	↓
Serie		100 (3x)
Total		100 (3x)

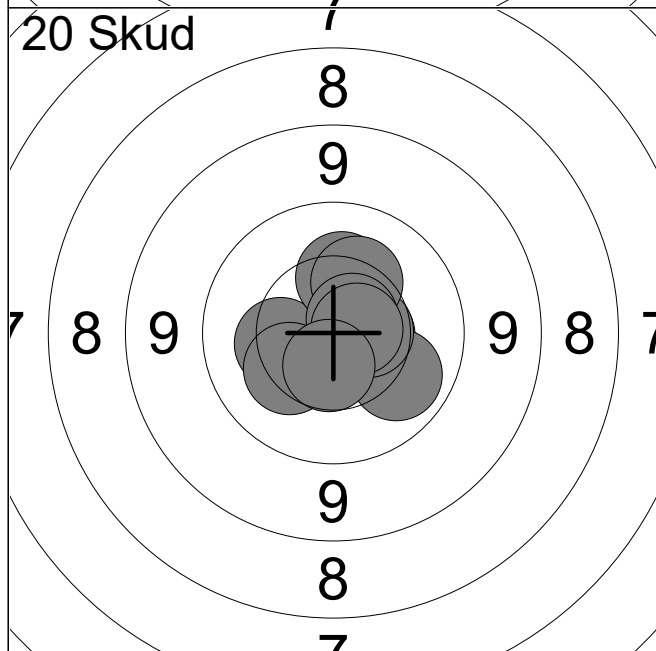

11:	10.5	→
12:	10.1	↘
13:	10.3	←
14:	10.3	↑
15:	10.5	→
16:	10.3	↑
17:	10.3	↙
18:	10.7x	↗
19:	10.7x	→
20:	10.6	↓
Serie		100 (2x)
Total		200 (5x)

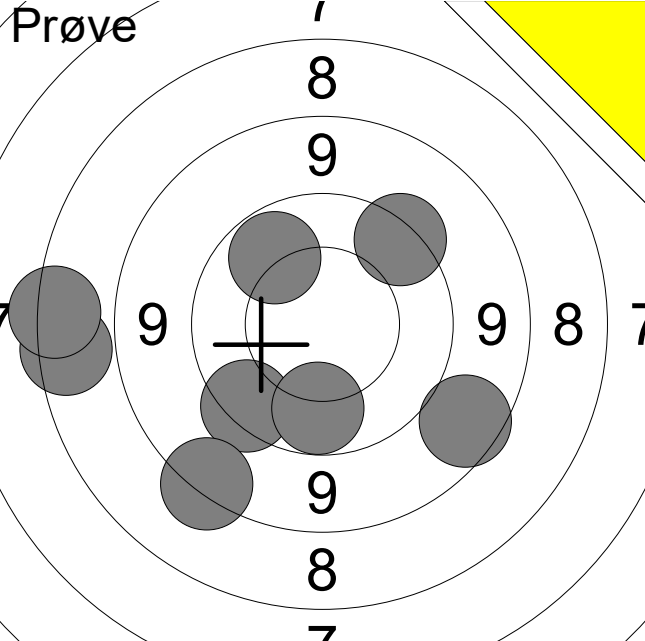
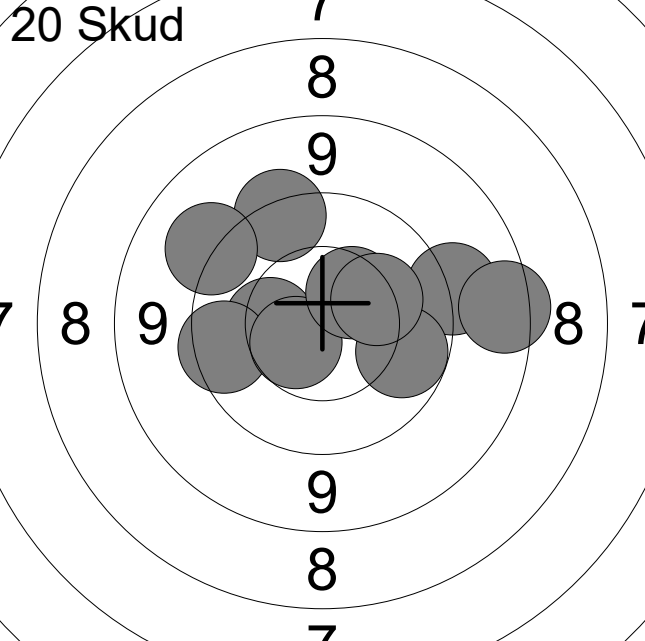
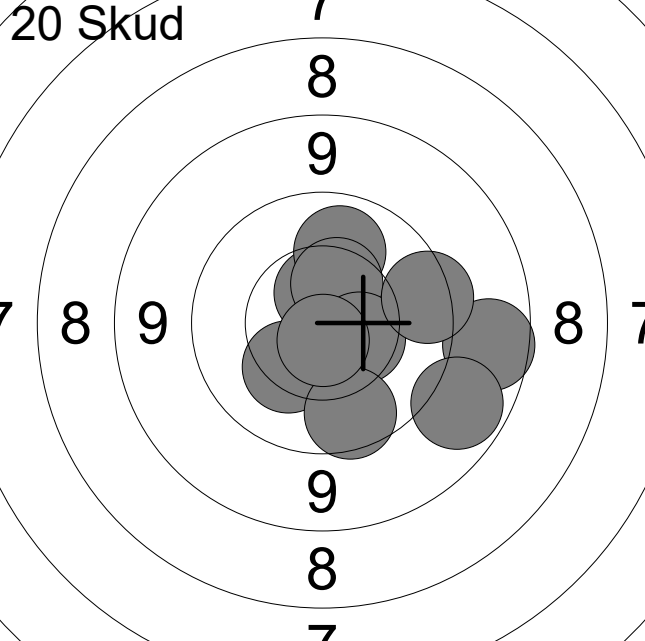
Hold 20	Skive 8	Allan J. Asmussen																																
ØSF		Frederikssund Skytteforening, I		ST2																														
28.10.2024		Halloween Luftstævne 2024		Ølstykke skytteforening																														
Prøve		<table border="0"> <tr><td>1:</td><td>9.6</td><td>↙</td></tr> <tr><td>2:</td><td>7.7</td><td>←</td></tr> <tr><td>3:</td><td>7.6</td><td>←</td></tr> <tr><td>4:</td><td>8.5</td><td>↙</td></tr> <tr><td>5:</td><td>9.6</td><td>↗</td></tr> <tr><td>6:</td><td>8.8</td><td>↘</td></tr> <tr><td>7:</td><td>10.0</td><td>↓</td></tr> <tr><td>8:</td><td>10.0</td><td>↗</td></tr> </table>			1:	9.6	↙	2:	7.7	←	3:	7.6	←	4:	8.5	↙	5:	9.6	↗	6:	8.8	↘	7:	10.0	↓	8:	10.0	↗						
1:	9.6	↙																																
2:	7.7	←																																
3:	7.6	←																																
4:	8.5	↙																																
5:	9.6	↗																																
6:	8.8	↘																																
7:	10.0	↓																																
8:	10.0	↗																																
		Serie 68 (0x)																																
		Total 0 (0x)																																
20 Skud		<table border="0"> <tr><td>1:</td><td>9.3</td><td>→</td></tr> <tr><td>2:</td><td>8.7</td><td>→</td></tr> <tr><td>3:</td><td>10.0</td><td>→</td></tr> <tr><td>4:</td><td>9.5</td><td>↗</td></tr> <tr><td>5:</td><td>10.3</td><td>←</td></tr> <tr><td>6:</td><td>9.7</td><td>←</td></tr> <tr><td>7:</td><td>10.6</td><td>↙</td></tr> <tr><td>8:</td><td>10.4</td><td>↗</td></tr> <tr><td>9:</td><td>9.3</td><td>↖</td></tr> <tr><td>10:</td><td>10.2</td><td>→</td></tr> </table>			1:	9.3	→	2:	8.7	→	3:	10.0	→	4:	9.5	↗	5:	10.3	←	6:	9.7	←	7:	10.6	↙	8:	10.4	↗	9:	9.3	↖	10:	10.2	→
1:	9.3	→																																
2:	8.7	→																																
3:	10.0	→																																
4:	9.5	↗																																
5:	10.3	←																																
6:	9.7	←																																
7:	10.6	↙																																
8:	10.4	↗																																
9:	9.3	↖																																
10:	10.2	→																																
		Serie 94 (0x)																																
		Total 94 (0x)																																
20 Skud		<table border="0"> <tr><td>11:</td><td>10.6x</td><td>↑</td></tr> <tr><td>12:</td><td>10.1</td><td>↑</td></tr> <tr><td>13:</td><td>8.9</td><td>→</td></tr> <tr><td>14:</td><td>10.5</td><td>↗</td></tr> <tr><td>15:</td><td>9.0</td><td>↘</td></tr> <tr><td>16:</td><td>10.5</td><td>→</td></tr> <tr><td>17:</td><td>10.3</td><td>↙</td></tr> <tr><td>18:</td><td>9.8</td><td>↘</td></tr> <tr><td>19:</td><td>9.6</td><td>→</td></tr> <tr><td>20:</td><td>10.7x</td><td>↓</td></tr> </table>			11:	10.6x	↑	12:	10.1	↑	13:	8.9	→	14:	10.5	↗	15:	9.0	↘	16:	10.5	→	17:	10.3	↙	18:	9.8	↘	19:	9.6	→	20:	10.7x	↓
11:	10.6x	↑																																
12:	10.1	↑																																
13:	8.9	→																																
14:	10.5	↗																																
15:	9.0	↘																																
16:	10.5	→																																
17:	10.3	↙																																
18:	9.8	↘																																
19:	9.6	→																																
20:	10.7x	↓																																
		Serie 95 (2x)																																
		Total 189 (2x)																																

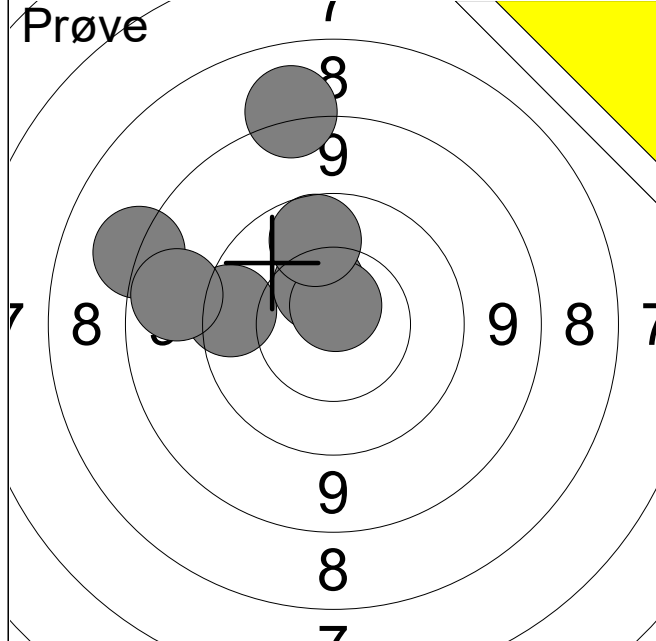

1:	8.4	←
2:	8.2	↑
3:	9.7	←
4:	9.0	←
5:	10.5	↑
6:	10.7x	↑
7:	9.9	↑
Serie		63 (1x)
Total		0 (0x)

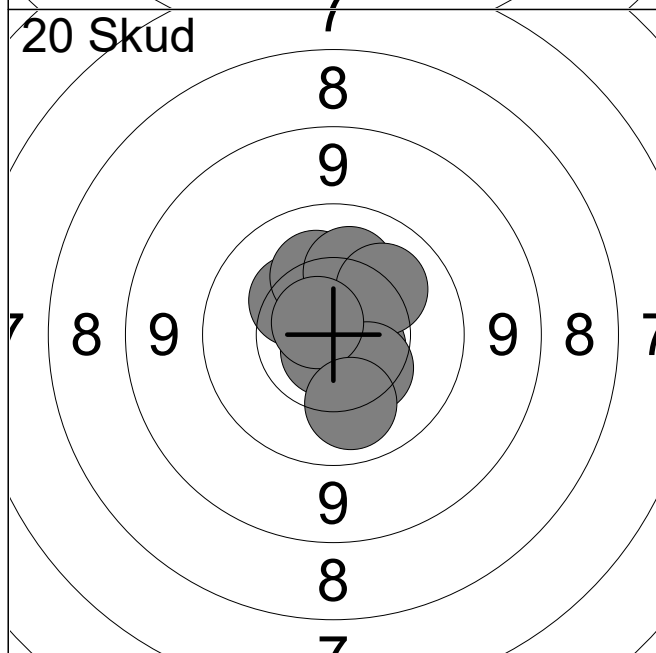

1:	10.3	↗
2:	10.2	↑
3:	10.7x	→
4:	10.6x	↘
5:	10.2	↑
6:	10.2	↗
7:	10.7x	↓
8:	10.4	↘
9:	10.7x	↗
10:	10.1	↓
Serie		100 (4x)
Total		100 (4x)

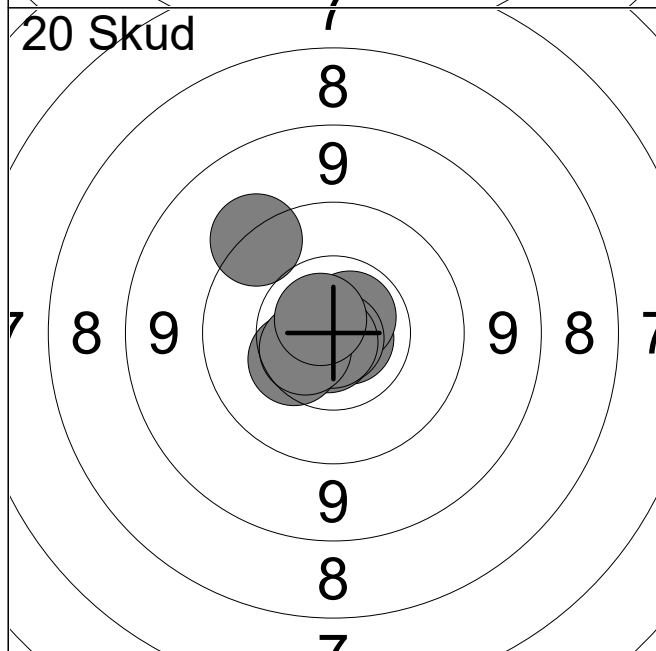

11:	10.8x	→
12:	10.8x	←
13:	10.8x	↓
14:	10.7x	↗
15:	10.9x	↘
16:	10.8x	↓
17:	10.4	←
18:	9.5	↗
19:	10.6	←
20:	10.7x	↗
Serie		99 (7x)
Total		199 (11x)

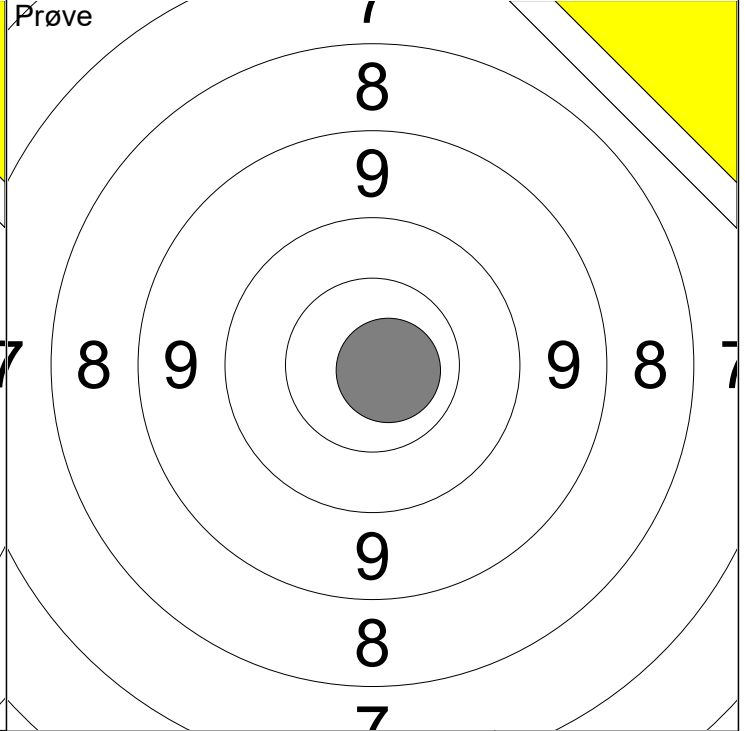
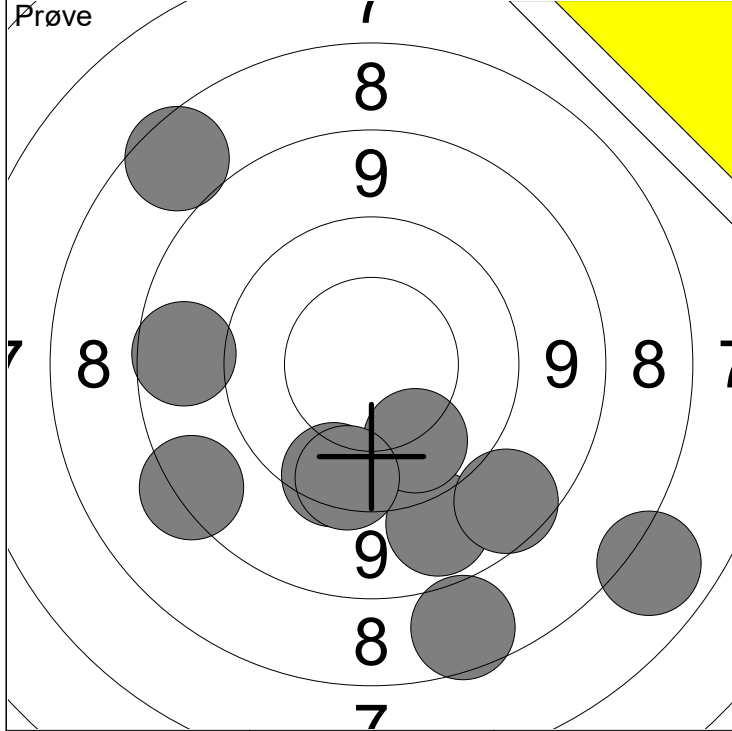

1: 9.1 ↓	6: 9.7 ↓	Serie 82 (0x)
2: 7.1 ↓	7: 10.0 ↓	
3: 7.8 ↓	8: 9.7 ↓	Total 0 (0x)
4: 8.9 ←	9: 8.8 ↓	
5: 8.5 ↙	10: 7.8 ↗	

11: 10.8x →	Serie 10 (1x)
	Total 0 (0x)

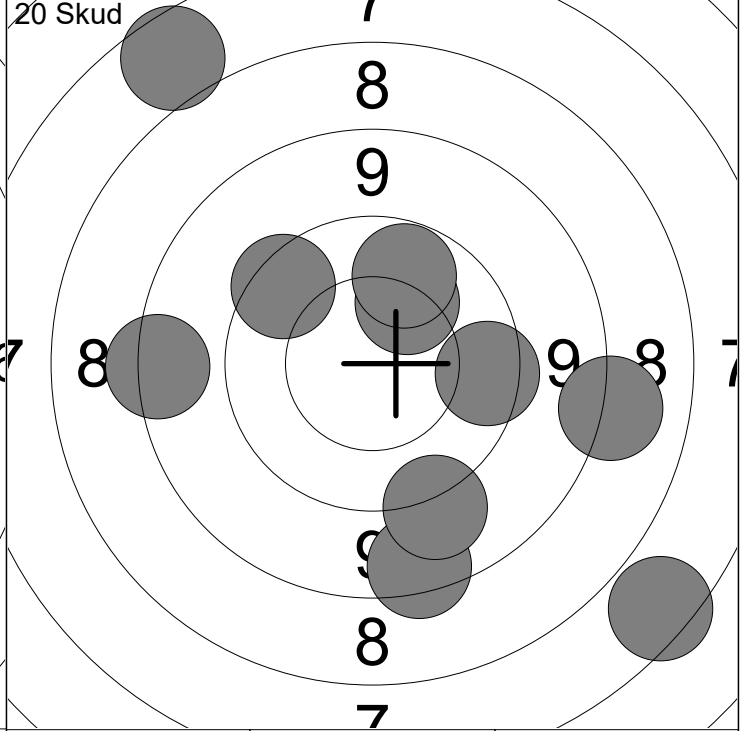
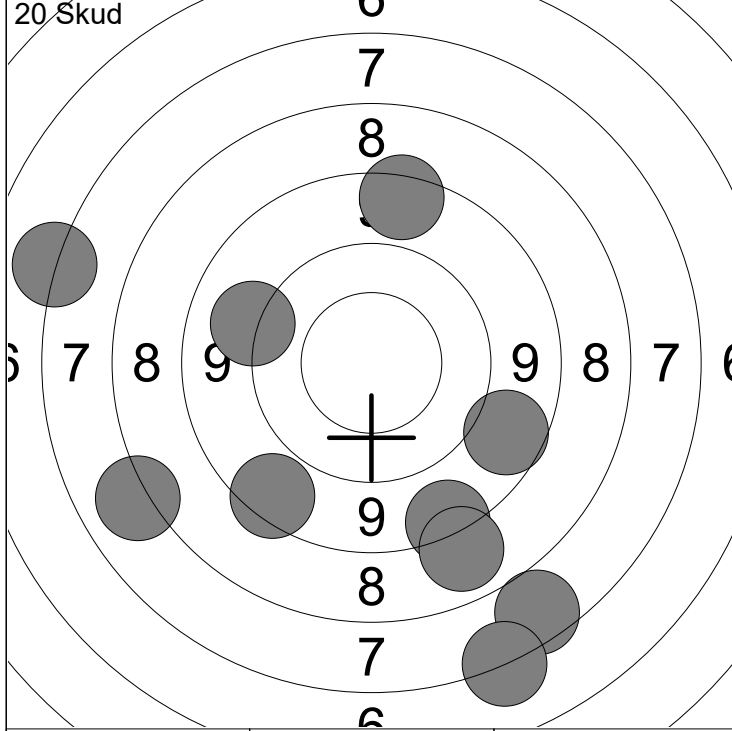

1: 6.8 ↓	6: 9.3 ←	Serie 74 (0x)
2: 7.2 ↙	7: 6.4 ↓	
3: 8.5 ↓	8: 8.7 ↑	Total 74 (0x)
4: 6.3 ↖	9: 8.1 ↓	
5: 8.9 ↓	10: 8.7 ↓	

11: 6.8 ↗	16: 8.6 ←	Serie 83 (0x)
12: 10.2 ↗	17: 9.7 →	
13: 9.7 ↖	18: 10.0 ↑	Total 157 (0x)
14: 8.7 ↓	19: 8.3 →	
15: 6.7 ↓	20: 9.2 ↓	

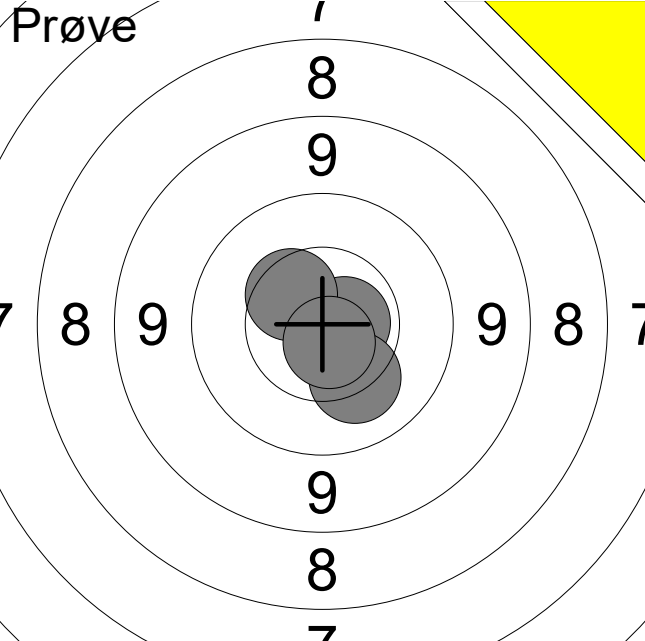
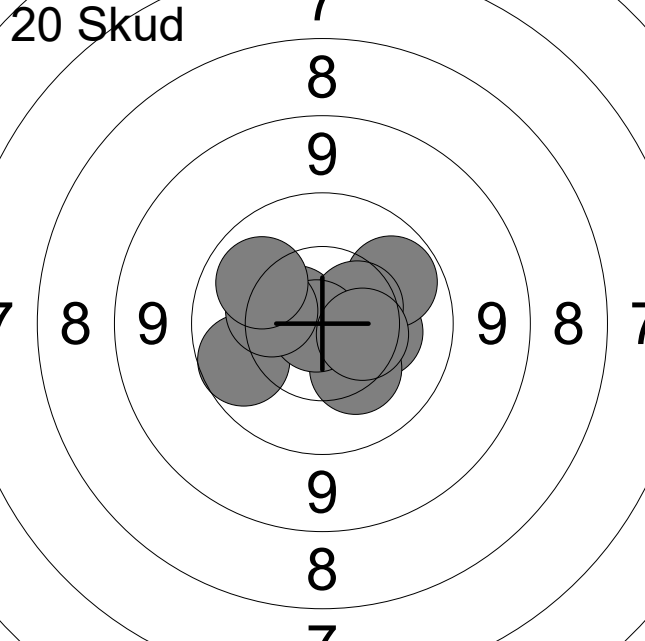
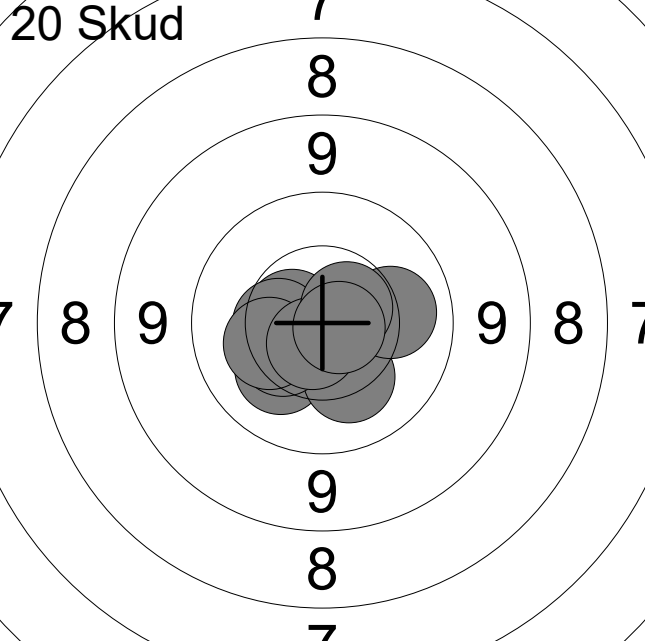
Hold 21	Skive 2	Selma Theilade		
ØSF		Skyttelaugget Kgs. Lyngby		MJ1
28.10.2024		Halloween Luftstævne 2024		Ølstykke skytteforening
Prøve		1: 10.7x → 2: 10.4 ↗ 3: 10.2 ↘ 4: 10.7x ↘		
		Serie 40 (2x) Total 0 (0x)		
20 Skud		1: 9.9 ← 2: 10.3 → 3: 10.3 ↘ 4: 10.6x ↗ 5: 10.0 ↗ 6: 10.5 → 7: 10.9x ← 8: 10.5 → 9: 10.3 ← 10: 10.1 ↗		
		Serie 99 (2x) Total 99 (2x)		
20 Skud		11: 10.2 ↘ 12: 10.2 ↘ 13: 10.6 ← 14: 10.4 ↘ 15: 10.4 ← 16: 10.1 → 17: 10.3 ← 18: 10.7x ↘ 19: 10.6x ↗ 20: 10.8x →		
		Serie 100 (3x) Total 199 (5x)		

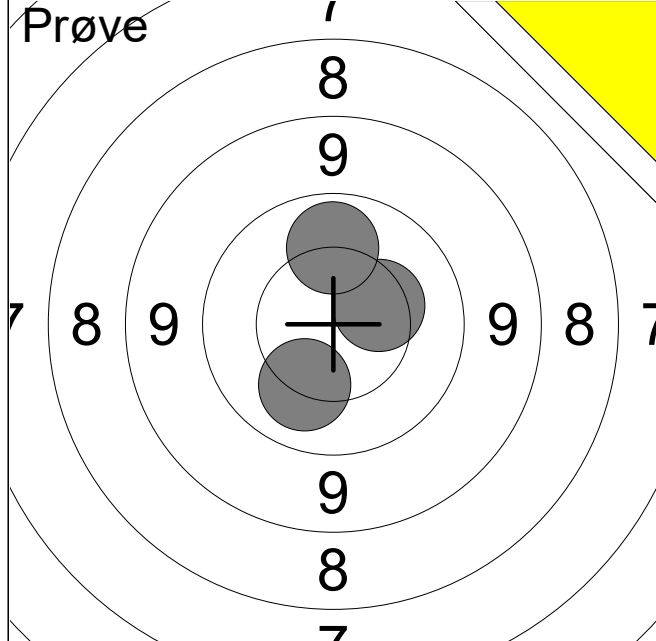

1:	10.2	↘
2:	10.4	→
3:	10.0	↑
Serie		30 (0x)
Total		0 (0x)

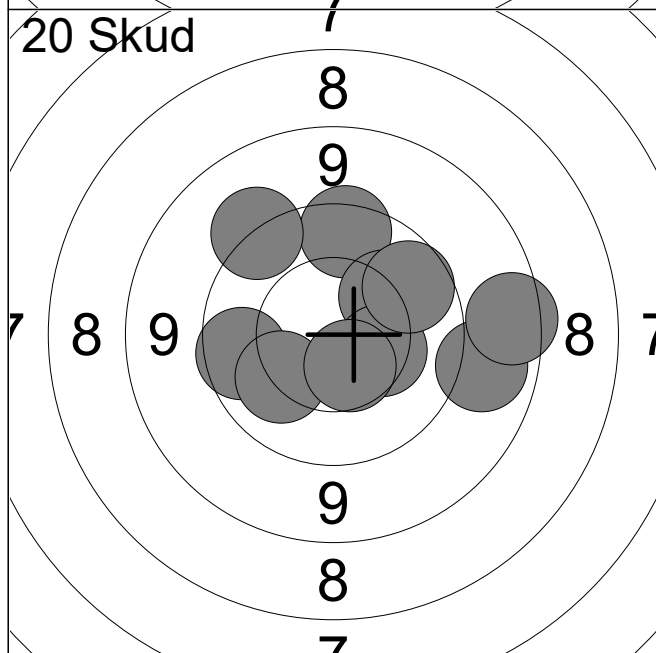

1:	9.1	→
2:	9.7	↑
3:	9.8	←
4:	10.2	↗
5:	10.4	→
6:	9.4	↗
7:	10.2	↙
8:	8.7	→
9:	9.9	↗
10:	10.5	↘
Serie		93 (0x)
Total		93 (0x)

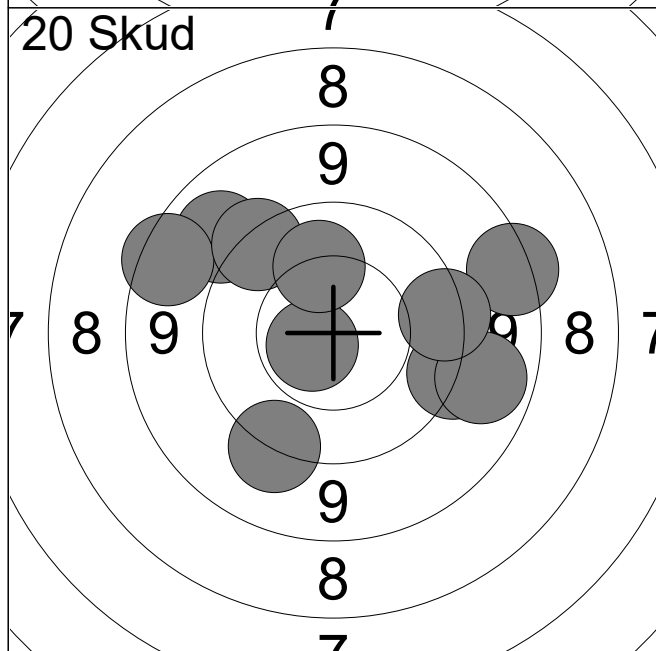

11:	8.6	→
12:	9.4	→
13:	9.4	↘
14:	10.7x	←
15:	9.0	→
16:	9.1	↗
17:	9.6	→
18:	8.7	↖
19:	9.5	↗
20:	10.1	↑
Serie		90 (1x)
Total		183 (1x)

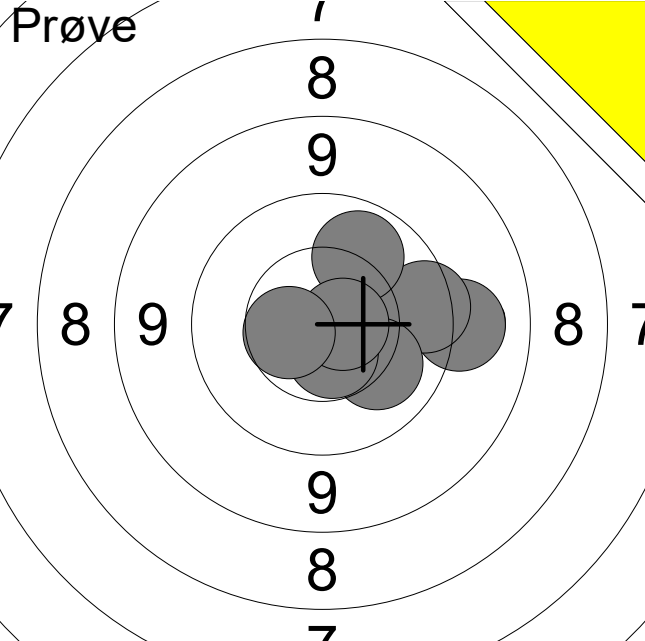
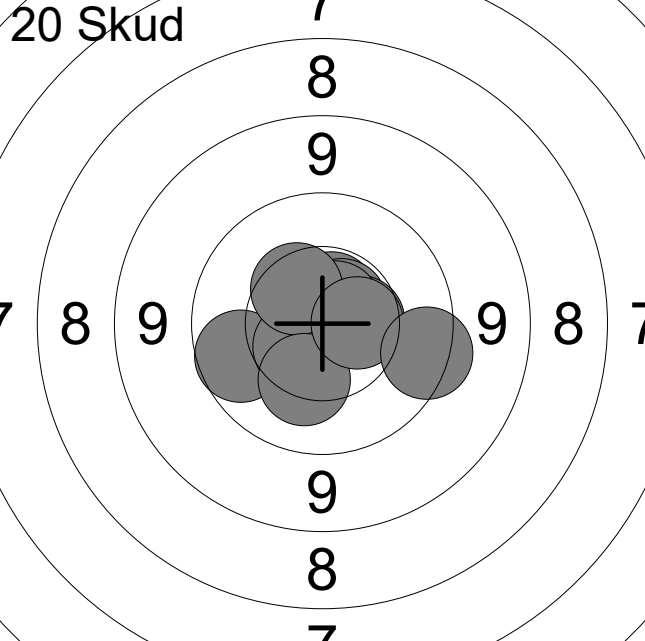
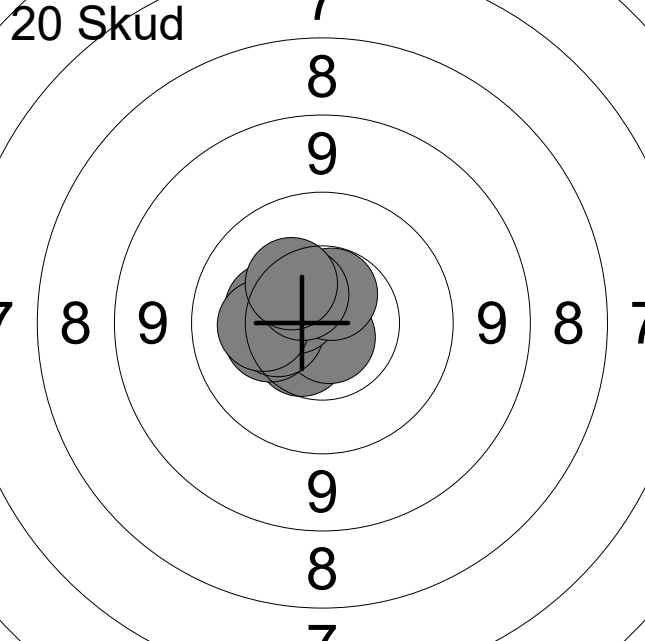
Hold 21	Skive 4	Frederik Lund-Vogensen																																
ØSF		Ganløse Skytteforening		J2																														
28.10.2024		Halloween Luftstævne 2024		Ølstykke skytteforening																														
Prøve		<table border="0"> <tr><td>1:</td><td>9.3</td><td>→</td></tr> <tr><td>2:</td><td>9.7</td><td>→</td></tr> <tr><td>3:</td><td>10.2</td><td>↘</td></tr> <tr><td>4:</td><td>10.6x</td><td>↘</td></tr> <tr><td>5:</td><td>10.0</td><td>↗</td></tr> <tr><td>6:</td><td>10.7x</td><td>→</td></tr> <tr><td>7:</td><td>10.5</td><td>←</td></tr> </table>			1:	9.3	→	2:	9.7	→	3:	10.2	↘	4:	10.6x	↘	5:	10.0	↗	6:	10.7x	→	7:	10.5	←									
1:	9.3	→																																
2:	9.7	→																																
3:	10.2	↘																																
4:	10.6x	↘																																
5:	10.0	↗																																
6:	10.7x	→																																
7:	10.5	←																																
		<table border="0"> <tr><td>Serie</td><td colspan="3">68 (2x)</td></tr> <tr><td>Total</td><td colspan="3">0 (0x)</td></tr> </table>			Serie	68 (2x)			Total	0 (0x)																								
Serie	68 (2x)																																	
Total	0 (0x)																																	
20 Skud		<table border="0"> <tr><td>1:</td><td>10.6x</td><td>↗</td></tr> <tr><td>2:</td><td>9.9</td><td>←</td></tr> <tr><td>3:</td><td>10.6x</td><td>↗</td></tr> <tr><td>4:</td><td>10.6</td><td>↘</td></tr> <tr><td>5:</td><td>10.5</td><td>→</td></tr> <tr><td>6:</td><td>10.7x</td><td>↗</td></tr> <tr><td>7:</td><td>10.4</td><td>↗</td></tr> <tr><td>8:</td><td>10.3</td><td>↘</td></tr> <tr><td>9:</td><td>10.5</td><td>→</td></tr> <tr><td>10:</td><td>9.6</td><td>→</td></tr> </table>			1:	10.6x	↗	2:	9.9	←	3:	10.6x	↗	4:	10.6	↘	5:	10.5	→	6:	10.7x	↗	7:	10.4	↗	8:	10.3	↘	9:	10.5	→	10:	9.6	→
1:	10.6x	↗																																
2:	9.9	←																																
3:	10.6x	↗																																
4:	10.6	↘																																
5:	10.5	→																																
6:	10.7x	↗																																
7:	10.4	↗																																
8:	10.3	↘																																
9:	10.5	→																																
10:	9.6	→																																
		<table border="0"> <tr><td>Serie</td><td colspan="3">98 (3x)</td></tr> <tr><td>Total</td><td colspan="3">98 (3x)</td></tr> </table>			Serie	98 (3x)			Total	98 (3x)																								
Serie	98 (3x)																																	
Total	98 (3x)																																	
20 Skud		<table border="0"> <tr><td>11:</td><td>10.5</td><td>↘</td></tr> <tr><td>12:</td><td>10.3</td><td>←</td></tr> <tr><td>13:</td><td>10.8x</td><td>↘</td></tr> <tr><td>14:</td><td>10.4</td><td>←</td></tr> <tr><td>15:</td><td>10.3</td><td>←</td></tr> <tr><td>16:</td><td>10.6</td><td>↗</td></tr> <tr><td>17:</td><td>10.3</td><td>←</td></tr> <tr><td>18:</td><td>10.6x</td><td>↗</td></tr> <tr><td>19:</td><td>10.5</td><td>↗</td></tr> <tr><td>20:</td><td>10.4</td><td>↗</td></tr> </table>			11:	10.5	↘	12:	10.3	←	13:	10.8x	↘	14:	10.4	←	15:	10.3	←	16:	10.6	↗	17:	10.3	←	18:	10.6x	↗	19:	10.5	↗	20:	10.4	↗
11:	10.5	↘																																
12:	10.3	←																																
13:	10.8x	↘																																
14:	10.4	←																																
15:	10.3	←																																
16:	10.6	↗																																
17:	10.3	←																																
18:	10.6x	↗																																
19:	10.5	↗																																
20:	10.4	↗																																
		<table border="0"> <tr><td>Serie</td><td colspan="3">100 (2x)</td></tr> <tr><td>Total</td><td colspan="3">198 (5x)</td></tr> </table>			Serie	100 (2x)			Total	198 (5x)																								
Serie	100 (2x)																																	
Total	198 (5x)																																	

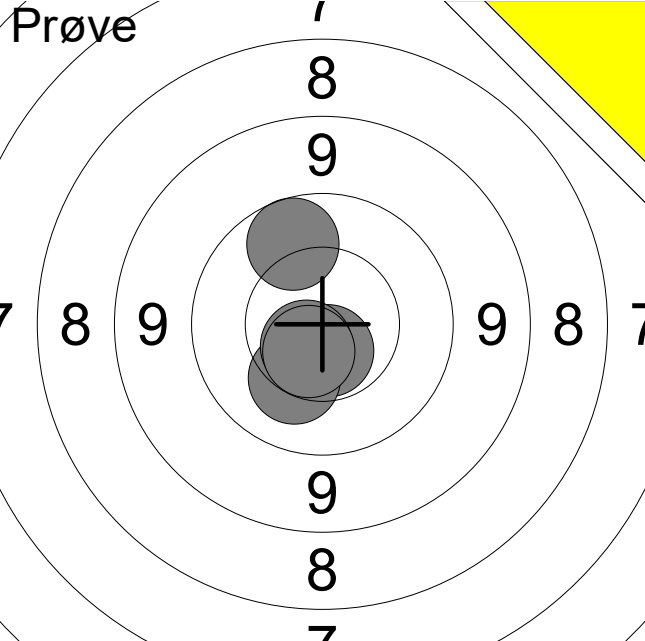
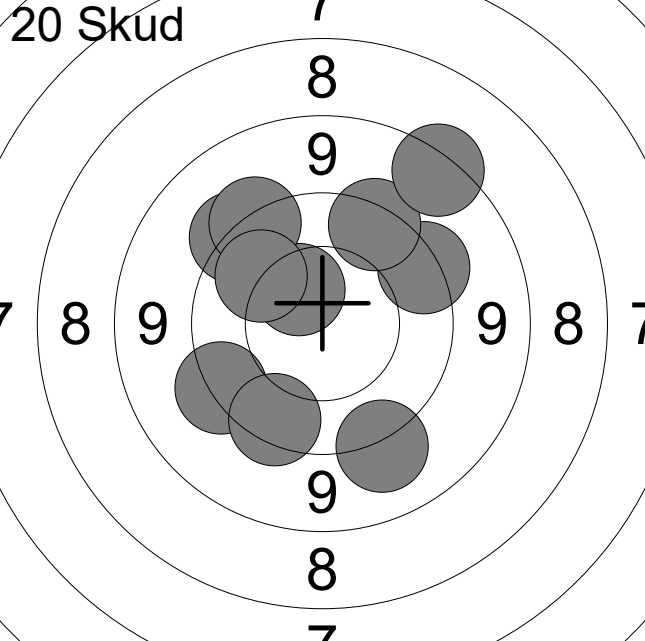
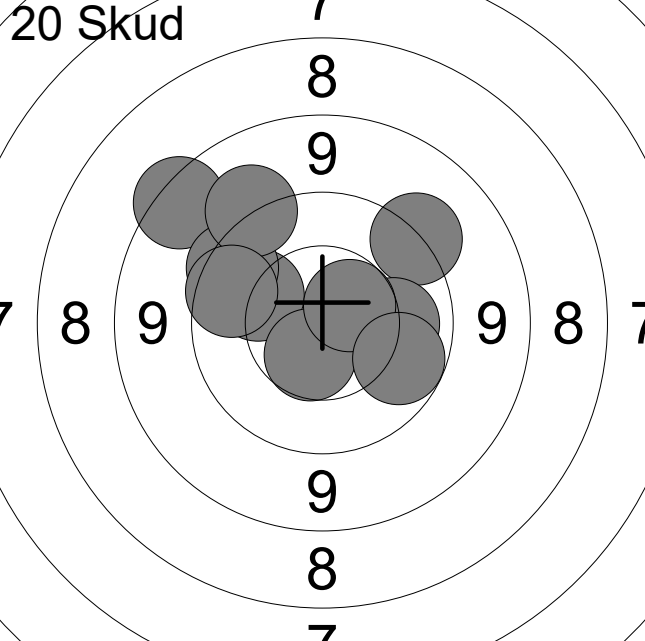
Hold 21	Skive 8	Jonatan Bekö		
ØSF		Ølstykke Skytteforening		MBK3
28.10.2024		Halloween Luftstævne 2024		Ølstykke skytteforening
Prøve		1: 10.6x ↓ 2: 10.2 ↓ 3: 9.9 ↑ 4: 10.6x ↓ 5: 10.6x ↓		
		Serie 49 (3x) Total 0 (0x)		
20 Skud		1: 9.5 ↗ 2: 10.5 ↗ 3: 9.5 ↗ 4: 9.5 ↗ 5: 9.6 ↗ 6: 10.0 ↗ 7: 9.5 ↖ 8: 8.6 ↗ 9: 9.7 ↓ 10: 9.3 ↓		
		Serie 91 (0x) Total 91 (0x)		
20 Skud		11: 10.1 ↖ 12: 9.4 ↗ 13: 8.6 ↗ 14: 9.7 ↗ 15: 9.3 ↗ 16: 10.5 ↓ 17: 9.8 ↖ 18: 10.1 → 19: 10.6 ↗ 20: 10.0 ↘		
		Serie 94 (0x) Total 185 (0x)		

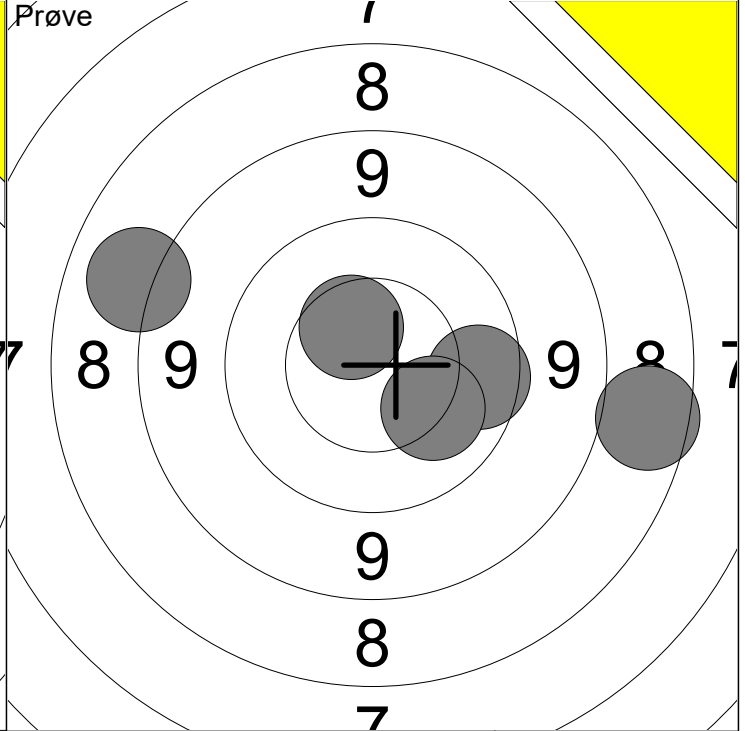
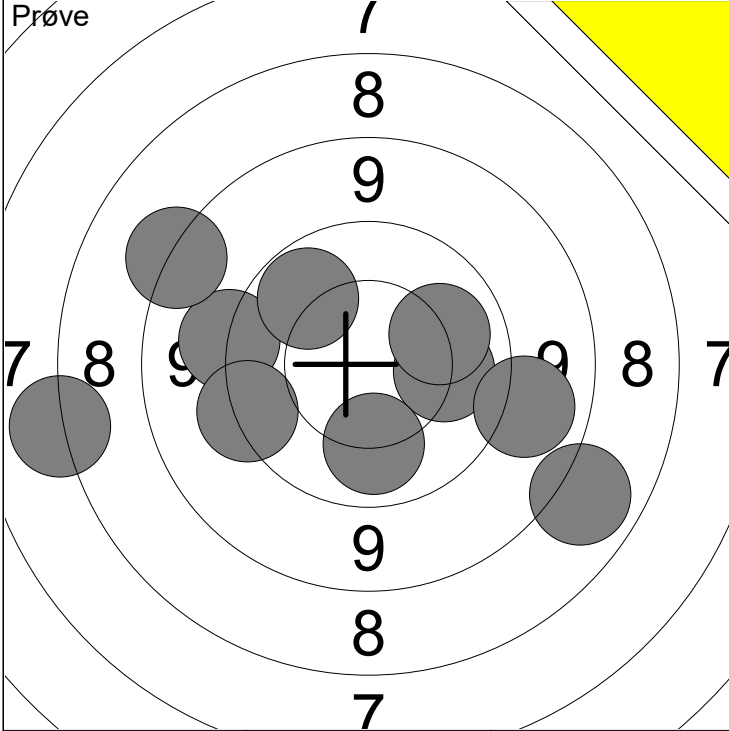

1: 10.1 →	6: 10.0 ↖	Serie 90 (0x)
2: 9.4 ←	7: 8.1 ↘	
3: 9.1 →	8: 7.3 ←	Total 0 (0x)
4: 8.4 ↗	9: 9.5 ←	
5: 10.1 ↓	10: 10.1 →	

11: 7.8 →	Serie 44 (0x)
12: 8.2 ←	
13: 9.8 →	Total 0 (0x)
14: 10.5 ↗	
15: 10.2 ↘	

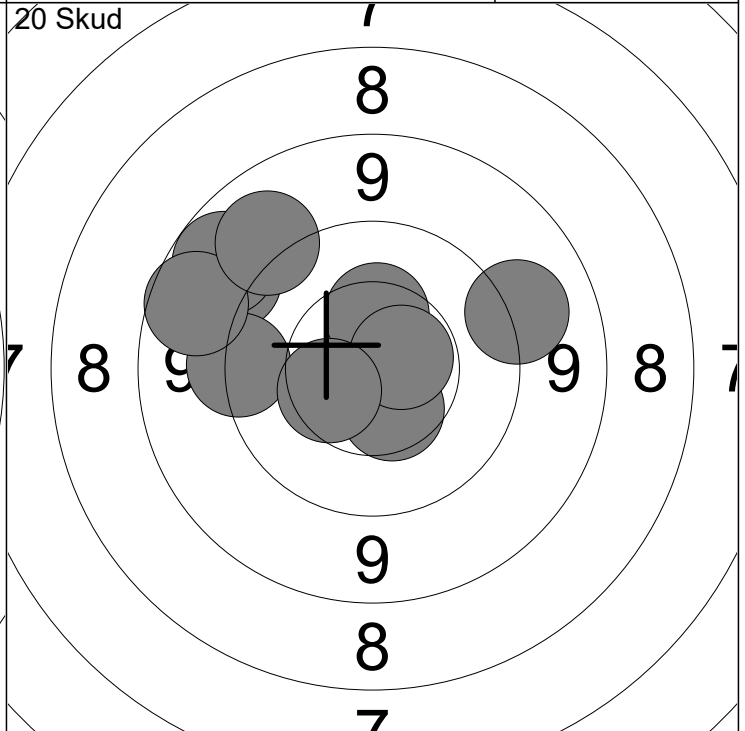
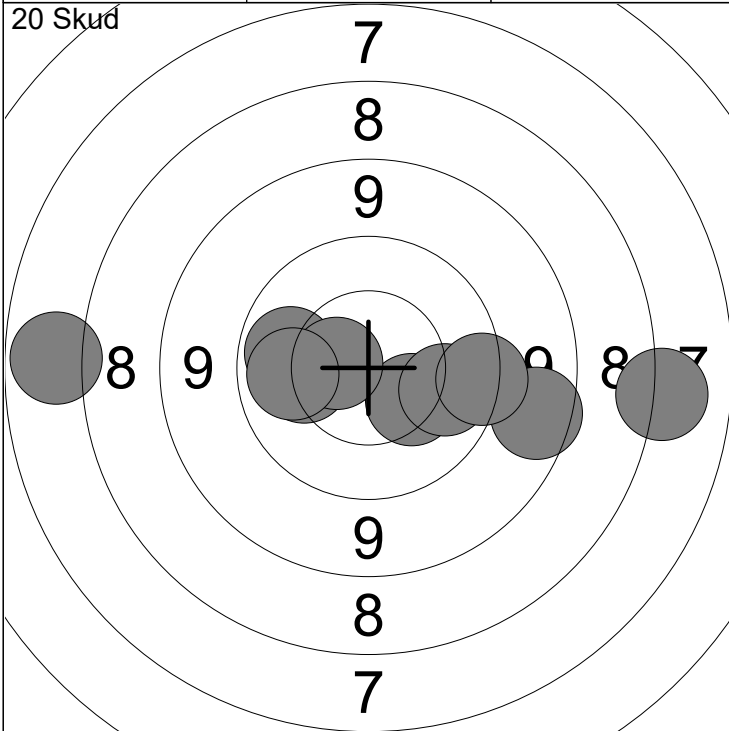

1: 10.3 ↘	6: 10.2 ←	Serie 91 (0x)
2: 10.0 ←	7: 10.6 ←	
3: 10.0 →	8: 7.2 →	Total 91 (0x)
4: 8.8 →	9: 10.1 ←	
5: 7.0 ←	10: 9.6 →	

11: 9.1 ←	16: 9.0 ←	Serie 93 (1x)
12: 10.4 ↑	17: 8.9 ←	
13: 9.5 ←	18: 10.6x →	Total 184 (1x)
14: 10.5 ↓	19: 10.4 ←	
15: 9.3 →	20: 9.2 ↖	

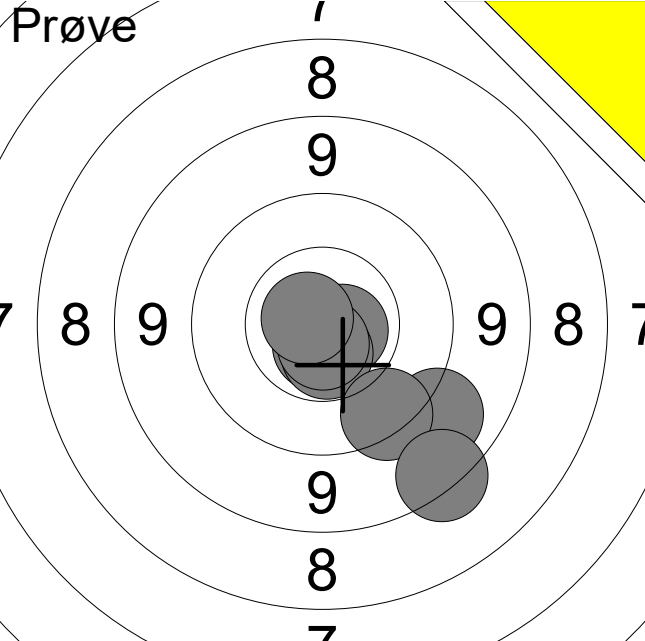
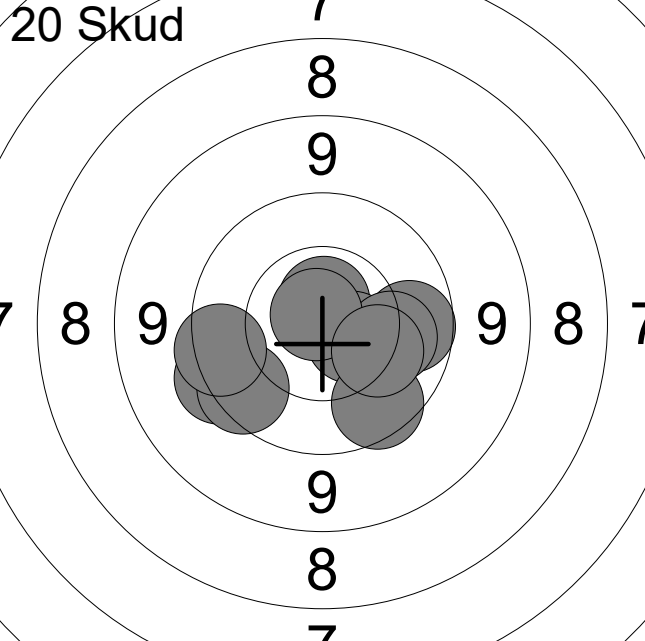
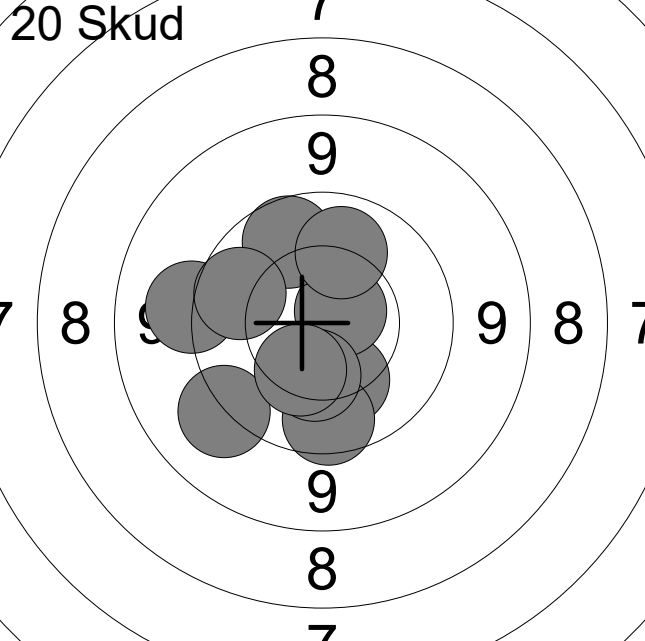
Hold 22	Skive 3	Per Lund Pedersen																																
ØSF		Holmegaard Skytteforening		SE1																														
28.10.2024		Halloween Luftstævne 2024		Ølstykke skytteforening																														
Prøve		<table border="0"> <tr><td>1:</td><td>10.7x</td><td>→</td></tr> <tr><td>2:</td><td>10.7x</td><td>↓</td></tr> <tr><td>3:</td><td>9.2</td><td>↘</td></tr> <tr><td>4:</td><td>10.6x</td><td>↓</td></tr> <tr><td>5:</td><td>10.7x</td><td>↓</td></tr> <tr><td>6:</td><td>9.6</td><td>↘</td></tr> <tr><td>7:</td><td>8.5</td><td>↘</td></tr> <tr><td>8:</td><td>10.8x</td><td>↑</td></tr> </table>			1:	10.7x	→	2:	10.7x	↓	3:	9.2	↘	4:	10.6x	↓	5:	10.7x	↓	6:	9.6	↘	7:	8.5	↘	8:	10.8x	↑						
1:	10.7x	→																																
2:	10.7x	↓																																
3:	9.2	↘																																
4:	10.6x	↓																																
5:	10.7x	↓																																
6:	9.6	↘																																
7:	8.5	↘																																
8:	10.8x	↑																																
		Serie 76 (5x)																																
		Total 0 (0x)																																
20 Skud		<table border="0"> <tr><td>1:</td><td>10.7x</td><td>↑</td></tr> <tr><td>2:</td><td>10.6</td><td>→</td></tr> <tr><td>3:</td><td>9.9</td><td>→</td></tr> <tr><td>4:</td><td>9.8</td><td>↘</td></tr> <tr><td>5:</td><td>10.1</td><td>→</td></tr> <tr><td>6:</td><td>9.6</td><td>←</td></tr> <tr><td>7:</td><td>9.7</td><td>←</td></tr> <tr><td>8:</td><td>10.8x</td><td>↗</td></tr> <tr><td>9:</td><td>9.7</td><td>←</td></tr> <tr><td>10:</td><td>10.2</td><td>↘</td></tr> </table>			1:	10.7x	↑	2:	10.6	→	3:	9.9	→	4:	9.8	↘	5:	10.1	→	6:	9.6	←	7:	9.7	←	8:	10.8x	↗	9:	9.7	←	10:	10.2	↘
1:	10.7x	↑																																
2:	10.6	→																																
3:	9.9	→																																
4:	9.8	↘																																
5:	10.1	→																																
6:	9.6	←																																
7:	9.7	←																																
8:	10.8x	↗																																
9:	9.7	←																																
10:	10.2	↘																																
		Serie 95 (2x)																																
		Total 95 (2x)																																
20 Skud		<table border="0"> <tr><td>11:</td><td>9.3</td><td>↙</td></tr> <tr><td>12:</td><td>10.2</td><td>↓</td></tr> <tr><td>13:</td><td>10.7x</td><td>↗</td></tr> <tr><td>14:</td><td>9.9</td><td>↗</td></tr> <tr><td>15:</td><td>9.8</td><td>↓</td></tr> <tr><td>16:</td><td>9.3</td><td>←</td></tr> <tr><td>17:</td><td>10.1</td><td>↑</td></tr> <tr><td>18:</td><td>10.3</td><td>↓</td></tr> <tr><td>19:</td><td>10.3</td><td>↘</td></tr> <tr><td>20:</td><td>9.9</td><td>←</td></tr> </table>			11:	9.3	↙	12:	10.2	↓	13:	10.7x	↗	14:	9.9	↗	15:	9.8	↓	16:	9.3	←	17:	10.1	↑	18:	10.3	↓	19:	10.3	↘	20:	9.9	←
11:	9.3	↙																																
12:	10.2	↓																																
13:	10.7x	↗																																
14:	9.9	↗																																
15:	9.8	↓																																
16:	9.3	←																																
17:	10.1	↑																																
18:	10.3	↓																																
19:	10.3	↘																																
20:	9.9	←																																
		Serie 95 (1x)																																
		Total 190 (3x)																																

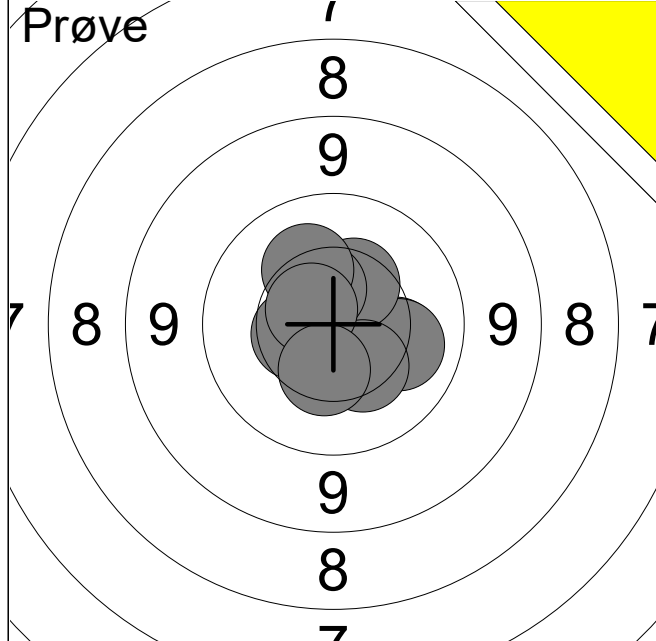

1:	10.2	→
2:	10.5	↘
3:	10.1	→
4:	10.5	←
5:	10.4	↗
6:	10.3	↘
7:	10.5	↗
8:	10.2	↗
9:	10.6x	↗
10:	10.4	↓
Serie		100 (1x)
Total		0 (0x)

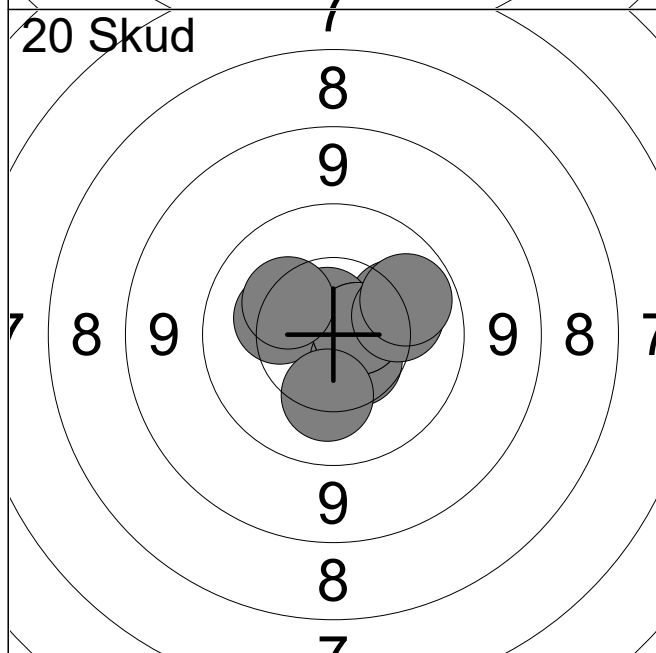

1:	10.2	↗
2:	10.7x	↗
3:	10.3	←
4:	10.5	↘
5:	10.7x	→
6:	10.7x	→
7:	10.2	→
8:	10.0	→
9:	10.3	↗
10:	10.2	↓
Serie		100 (3x)
Total		100 (3x)

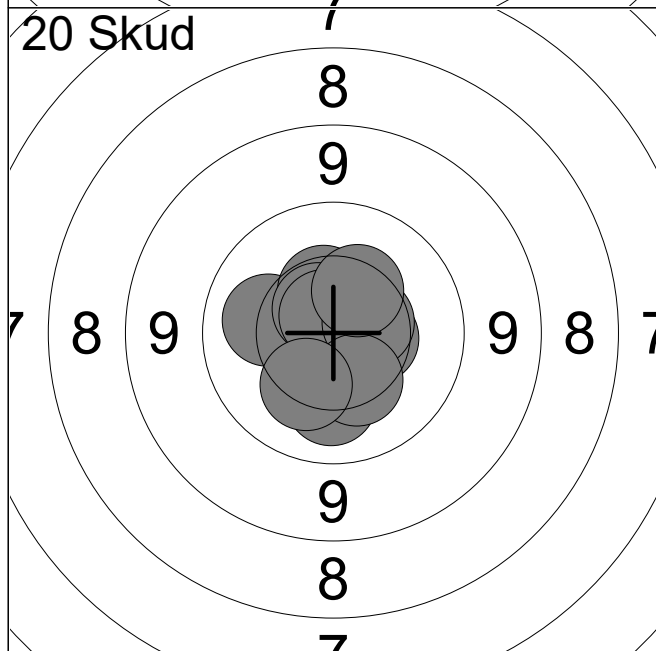

11:	10.5	→
12:	10.2	←
13:	10.2	↓
14:	10.4	↗
15:	10.6x	↗
16:	10.7x	↗
17:	10.5	→
18:	10.3	↘
19:	10.3	↘
20:	10.4	↗
Serie		100 (2x)
Total		200 (5x)

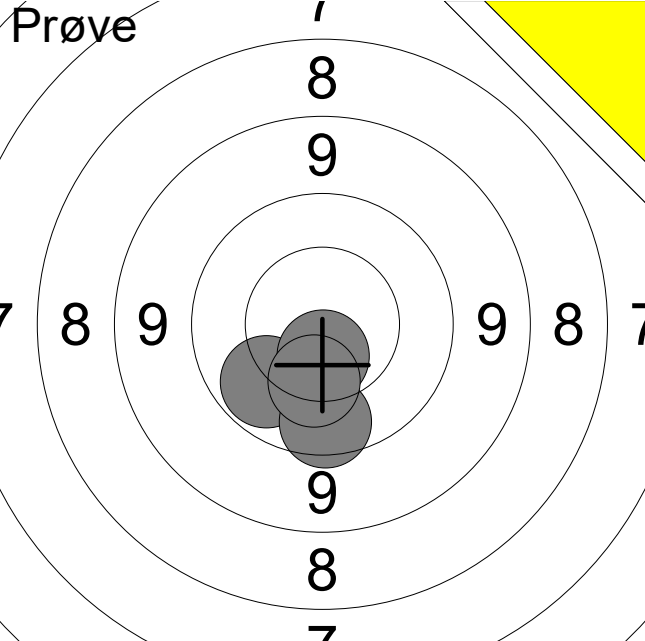
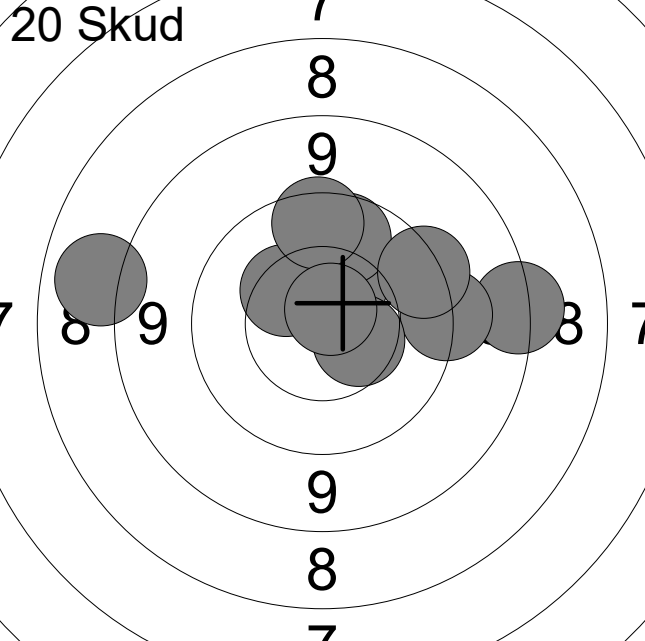
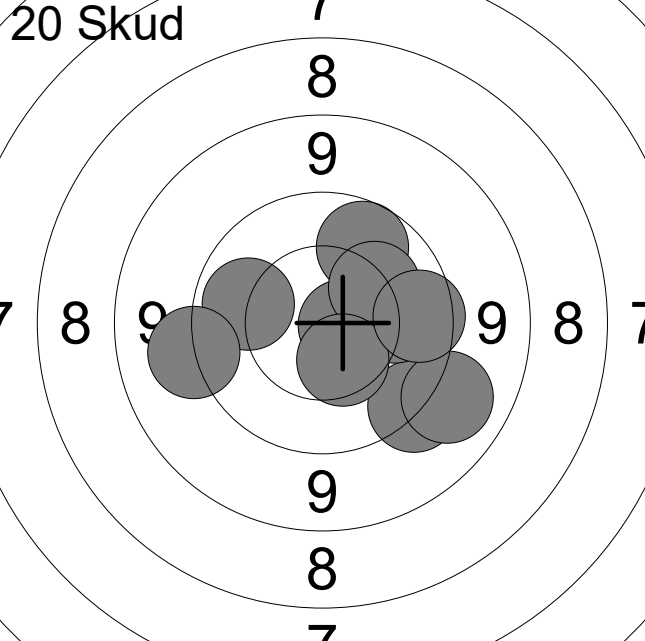
Hold 22	Skive 8	Allan J. Asmussen																																
ØSF		Frederikssund Skytteforening, I		MST2																														
28.10.2024		Halloween Luftstævne 2024		Ølstykke skytteforening																														
Prøve		<table border="0"> <tr><td>1:</td><td>10.0</td><td>↙</td></tr> <tr><td>2:</td><td>10.6</td><td>↓</td></tr> <tr><td>3:</td><td>9.8</td><td>↓</td></tr> <tr><td>4:</td><td>10.3</td><td>↓</td></tr> </table>			1:	10.0	↙	2:	10.6	↓	3:	9.8	↓	4:	10.3	↓																		
1:	10.0	↙																																
2:	10.6	↓																																
3:	9.8	↓																																
4:	10.3	↓																																
		<table border="0"> <tr><td>Serie</td><td colspan="2">39 (0x)</td></tr> <tr><td>Total</td><td colspan="2">0 (0x)</td></tr> </table>			Serie	39 (0x)		Total	0 (0x)																									
Serie	39 (0x)																																	
Total	0 (0x)																																	
20 Skud		<table border="0"> <tr><td>1:</td><td>8.5</td><td>→</td></tr> <tr><td>2:</td><td>10.4</td><td>↑</td></tr> <tr><td>3:</td><td>10.4</td><td>↖</td></tr> <tr><td>4:</td><td>8.1</td><td>←</td></tr> <tr><td>5:</td><td>9.4</td><td>→</td></tr> <tr><td>6:</td><td>9.9</td><td>↑</td></tr> <tr><td>7:</td><td>9.6</td><td>↗</td></tr> <tr><td>8:</td><td>10.5</td><td>↘</td></tr> <tr><td>9:</td><td>9.7</td><td>↑</td></tr> <tr><td>10:</td><td>10.8x</td><td>↑</td></tr> </table>			1:	8.5	→	2:	10.4	↑	3:	10.4	↖	4:	8.1	←	5:	9.4	→	6:	9.9	↑	7:	9.6	↗	8:	10.5	↘	9:	9.7	↑	10:	10.8x	↑
1:	8.5	→																																
2:	10.4	↑																																
3:	10.4	↖																																
4:	8.1	←																																
5:	9.4	→																																
6:	9.9	↑																																
7:	9.6	↗																																
8:	10.5	↘																																
9:	9.7	↑																																
10:	10.8x	↑																																
		<table border="0"> <tr><td>Serie</td><td colspan="2">92 (1x)</td></tr> <tr><td>Total</td><td colspan="2">92 (1x)</td></tr> </table>			Serie	92 (1x)		Total	92 (1x)																									
Serie	92 (1x)																																	
Total	92 (1x)																																	
20 Skud		<table border="0"> <tr><td>11:</td><td>10.7x</td><td>→</td></tr> <tr><td>12:</td><td>9.9</td><td>↑</td></tr> <tr><td>13:</td><td>9.4</td><td>↘</td></tr> <tr><td>14:</td><td>9.2</td><td>↘</td></tr> <tr><td>15:</td><td>10.1</td><td>→</td></tr> <tr><td>16:</td><td>10.0</td><td>←</td></tr> <tr><td>17:</td><td>9.3</td><td>←</td></tr> <tr><td>18:</td><td>10.2</td><td>↗</td></tr> <tr><td>19:</td><td>10.5</td><td>↓</td></tr> <tr><td>20:</td><td>9.8</td><td>→</td></tr> </table>			11:	10.7x	→	12:	9.9	↑	13:	9.4	↘	14:	9.2	↘	15:	10.1	→	16:	10.0	←	17:	9.3	←	18:	10.2	↗	19:	10.5	↓	20:	9.8	→
11:	10.7x	→																																
12:	9.9	↑																																
13:	9.4	↘																																
14:	9.2	↘																																
15:	10.1	→																																
16:	10.0	←																																
17:	9.3	←																																
18:	10.2	↗																																
19:	10.5	↓																																
20:	9.8	→																																
		<table border="0"> <tr><td>Serie</td><td colspan="2">95 (1x)</td></tr> <tr><td>Total</td><td colspan="2">187 (2x)</td></tr> </table>			Serie	95 (1x)		Total	187 (2x)																									
Serie	95 (1x)																																	
Total	187 (2x)																																	

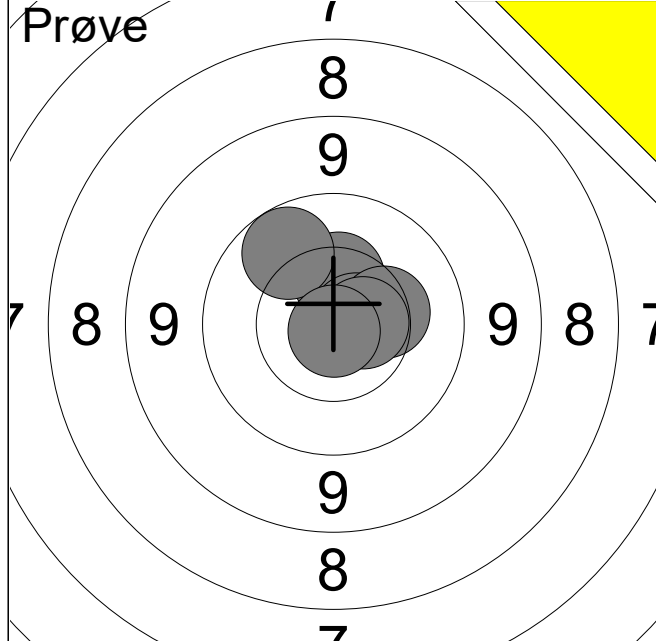

1:	10.4	↑
2:	10.7x	→
3:	10.3	→
4:	10.0	↖
5:	10.6x	→
6:	10.9x	↓
Serie		60 (3x)
Total		0 (0x)

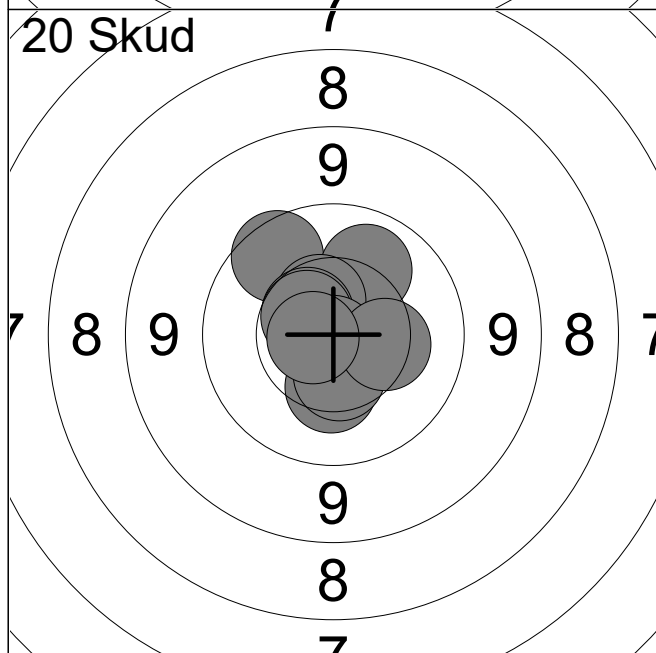

1:	9.8	↖
2:	10.1	↖
3:	10.5	↖
4:	10.6	↖
5:	10.3	↓
6:	10.6	↖
7:	10.9x	↓
8:	10.5	↓
9:	10.3	→
10:	10.7x	←
Serie		99 (2x)
Total		99 (2x)

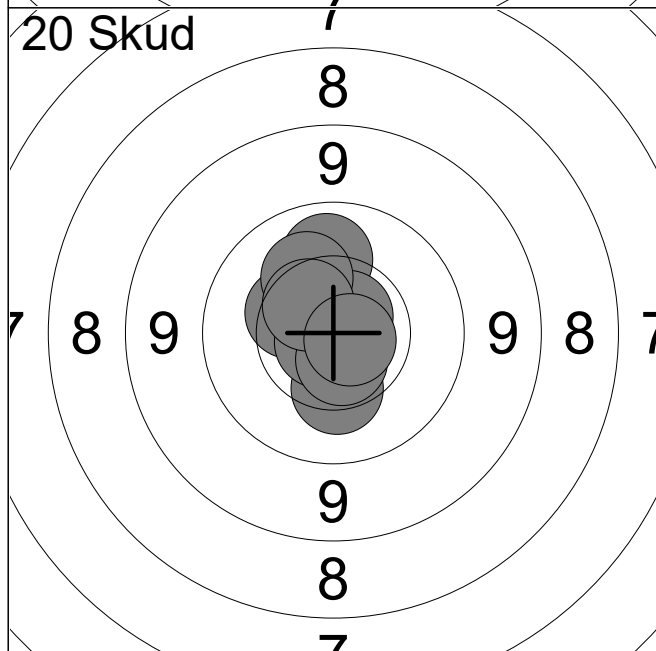

11:	10.1	↑
12:	10.8x	↑
13:	10.4	↖
14:	10.3	↓
15:	10.7x	↖
16:	10.8x	↖
17:	10.2	↖
18:	10.6x	↓
19:	10.5	↖
20:	10.7x	→
Serie		100 (5x)
Total		199 (7x)

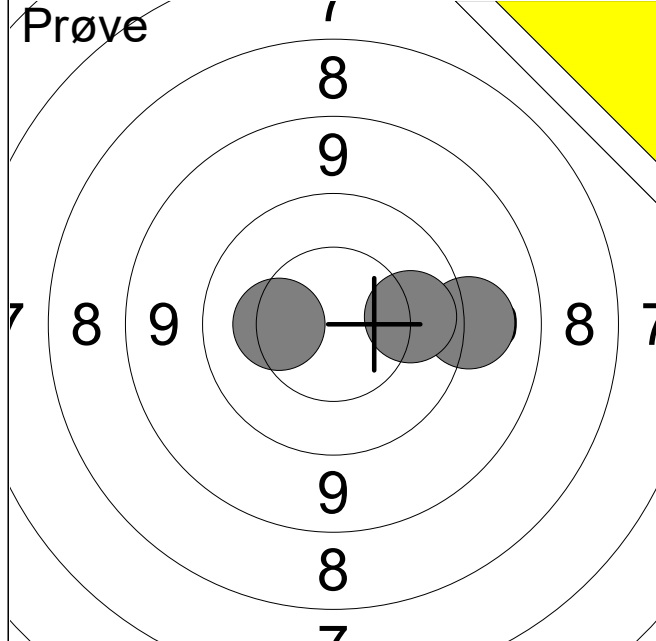

1:	9.3	→
2:	10.0	→
3:	10.3	←
Serie		29 (0x)
Total		0 (0x)

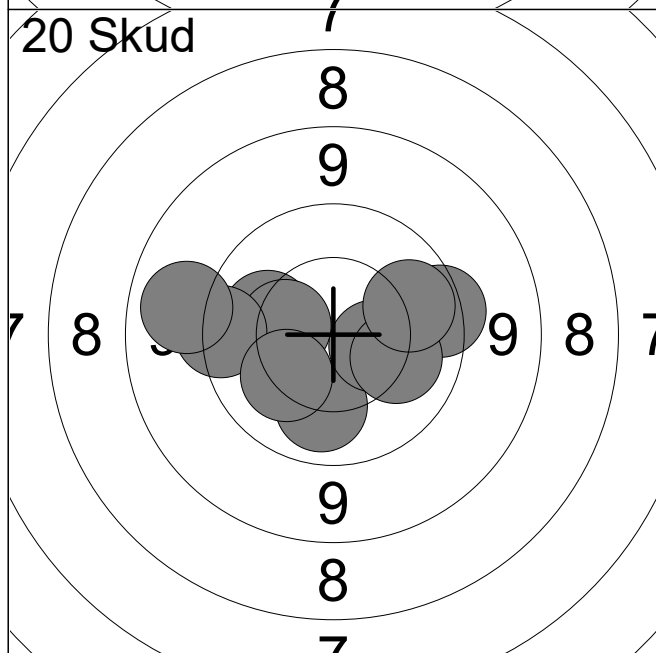

1:	10.1	←
2:	10.1	↓
3:	9.6	→
4:	10.4	←
5:	9.6	←
6:	9.1	←
7:	10.4	→
8:	10.2	↙
9:	10.2	→
10:	10.0	→
Serie		97 (0x)
Total		97 (0x)

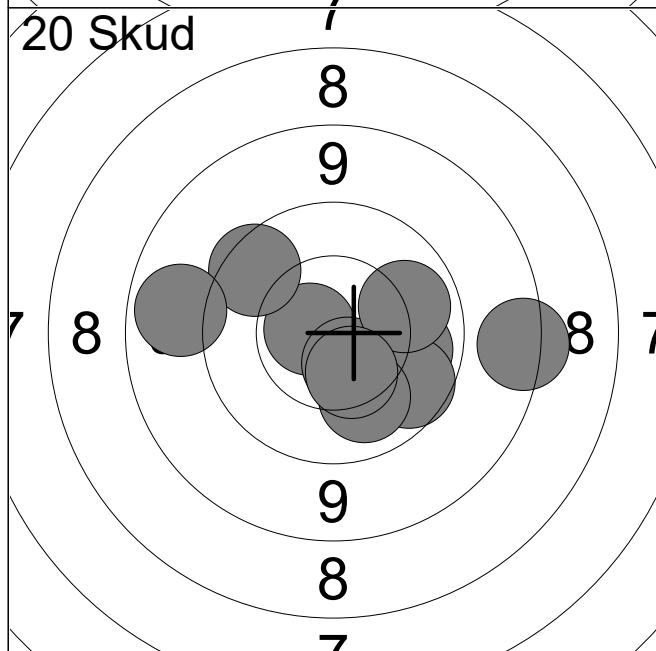

11:	10.1	→
12:	9.9	↘
13:	10.7x	←
14:	8.6	→
15:	10.6	↘
16:	9.7	↗
17:	10.1	↘
18:	9.0	←
19:	10.1	→
20:	10.4	↘
Serie		95 (1x)
Total		192 (1x)

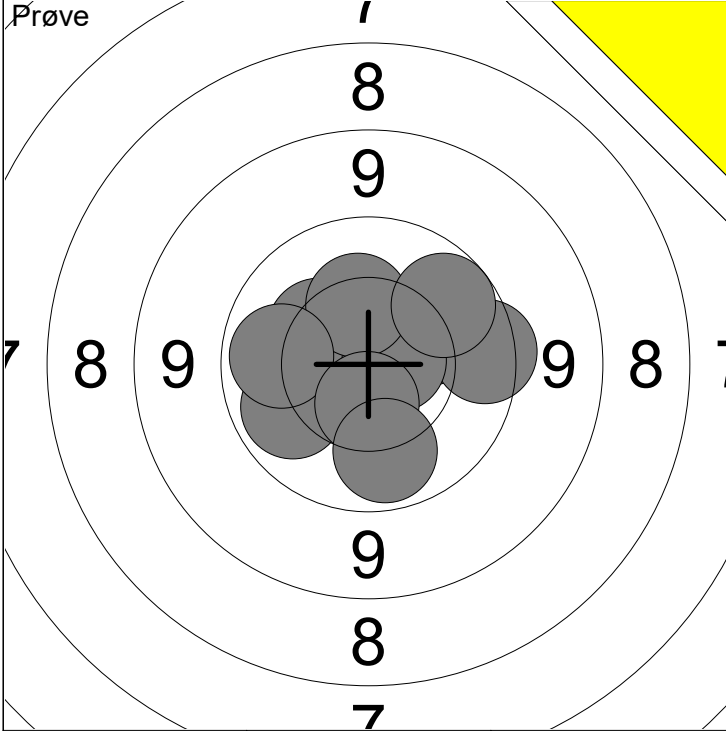

1: 10.0 ←	6: 10.3 ↑	Serie 98 (1x)
2: 10.3 ↖	7: 10.0 ←	
3: 10.2 ↗	8: 10.5 ↓	Total 0 (0x)
4: 9.7 →	9: 10.0 ↓	
5: 10.7x →	10: 9.9 ↗	

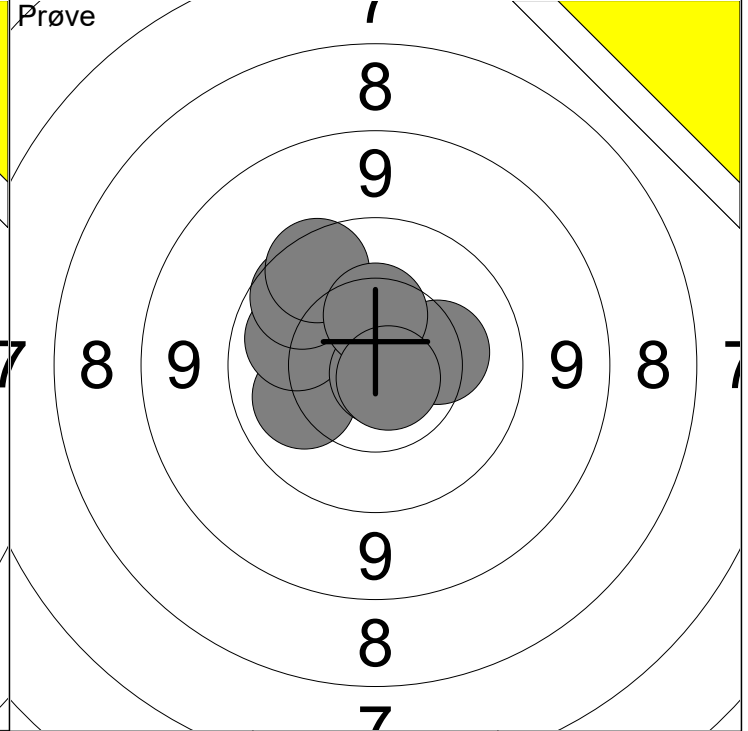

11: 10.1 ←	16: 10.3 →	Serie 98 (3x)
12: 10.7x ↑	17: 9.8 ↗	
13: 10.4 ↗	18: 10.8x ↘	Total 0 (0x)
14: 10.1 ←	19: 10.4 ↑	
15: 9.9 ↖	20: 10.8x ↘	

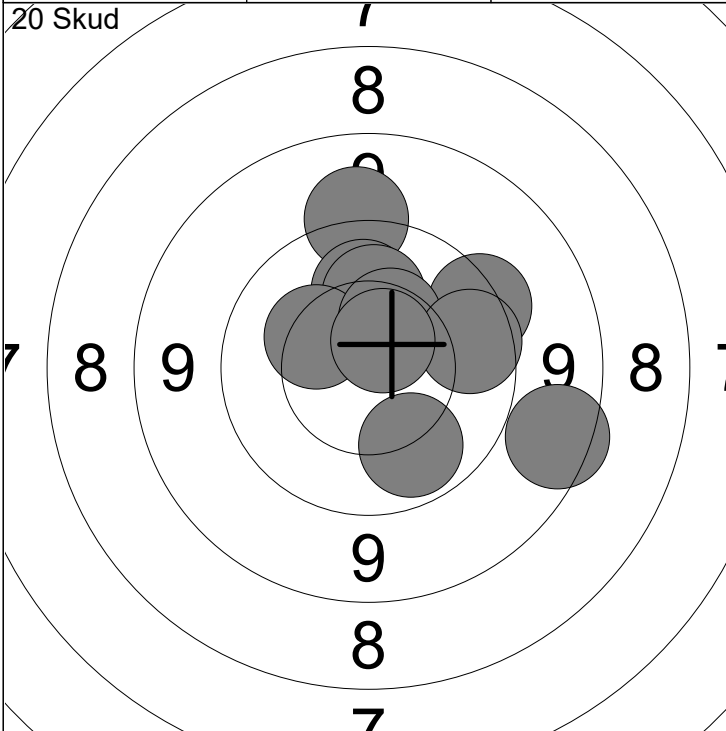

1: 9.3 ↑	6: 10.4 ↗	Serie 95 (1x)
2: 10.1 ↑	7: 8.7 →	
3: 10.2 ↑	8: 10.0 ↓	Total 95 (1x)
4: 9.6 ↗	9: 9.8 →	
5: 10.3 ↖	10: 10.6x ↗	

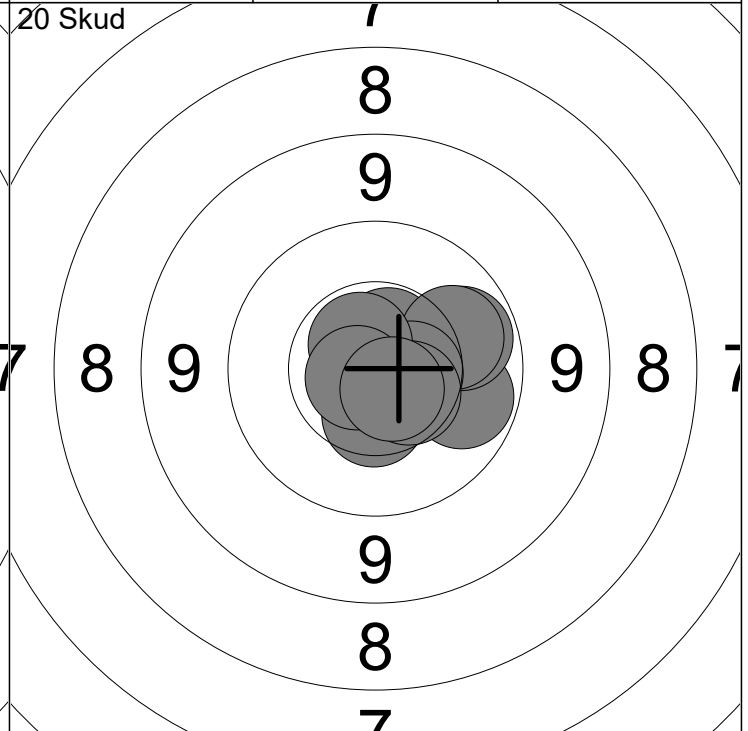

11: 10.5 ↓	16: 10.6 →	Serie 100 (4x)
12: 10.0 →	17: 10.5 ↘	
13: 10.0 →	18: 10.7x ↗	Total 195 (5x)
14: 10.6x ↑	19: 10.7x ←	
15: 10.1 →	20: 10.7x ↘	

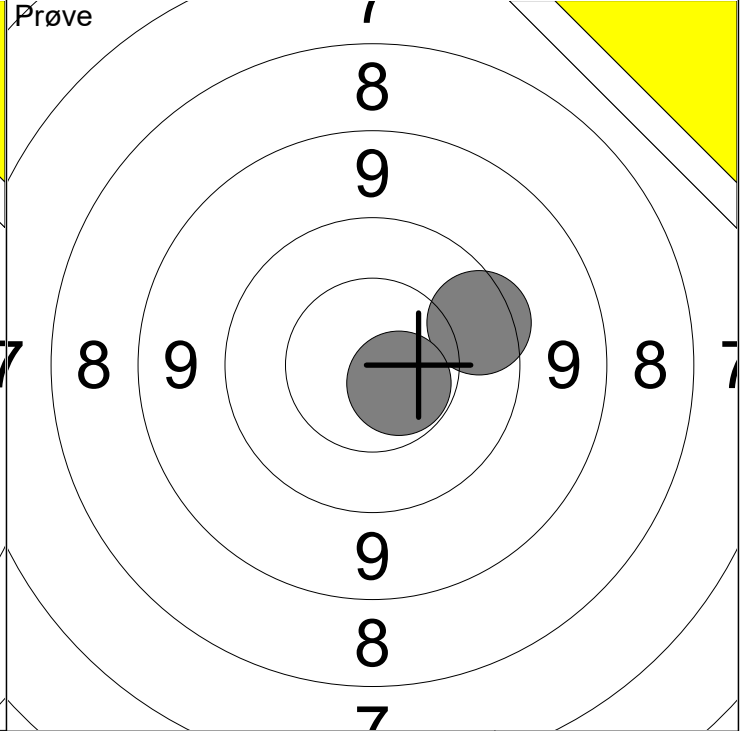
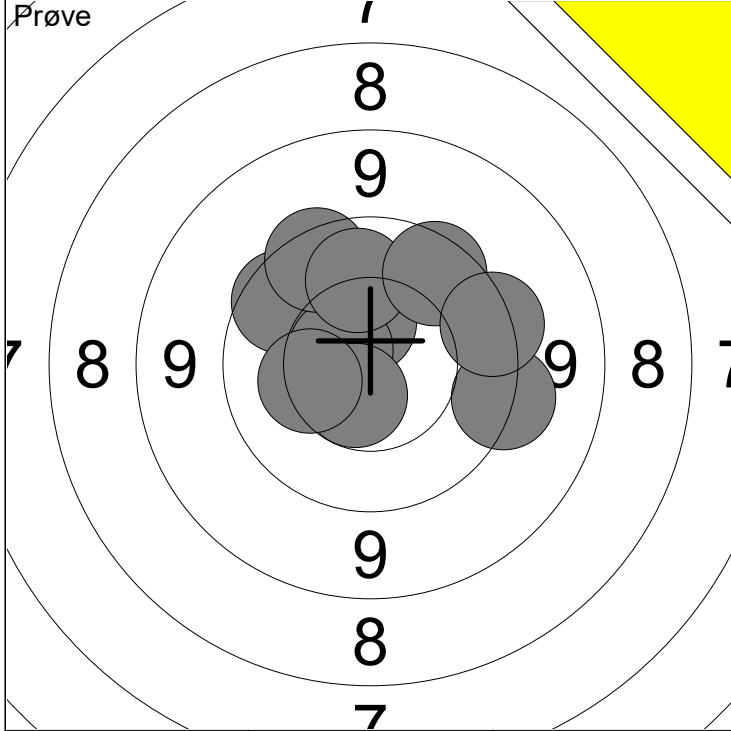

1: 9.5 →	6: 10.6x ↓	Serie	95 (2x)
2: 9.8 ↗	7: 10.1 ↑		
3: 10.5 ↑	8: 9.8 ↗	Total	0 (0x)
4: 10.6x ↖	9: 10.3 ←		
5: 9.7 ↗	10: 9.6 →		

11: 9.7 →	Serie	19 (1x)
12: 10.6x ↘		
Total		0 (0x)

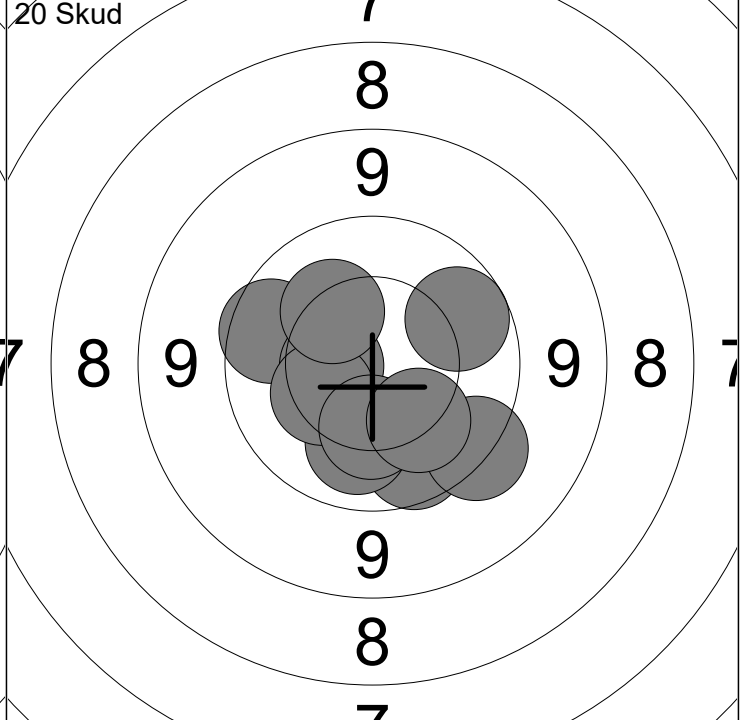
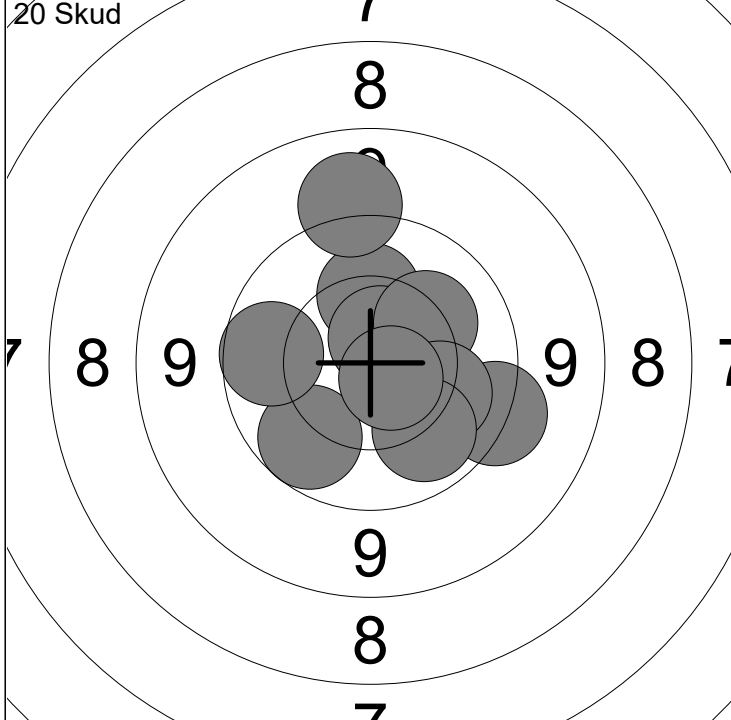

1: 10.2 ↑	6: 9.5 →	Serie	96 (2x)
2: 10.7x ↗	7: 10.2 →		
3: 10.2 ↗	8: 9.2 ↑	Total	96 (2x)
4: 9.9 ↘	9: 10.1 ↓		
5: 9.9 ←	10: 10.7x ↘		

11: 9.8 ←	16: 10.3 ←	Serie	96 (0x)
12: 10.5 ←	17: 10.3 ↗		
13: 9.9 ↗	18: 10.3 ↓	Total	192 (2x)
14: 9.9 ↓	19: 9.5 ↓		
15: 10.1 ↓	20: 10.2 ↓		

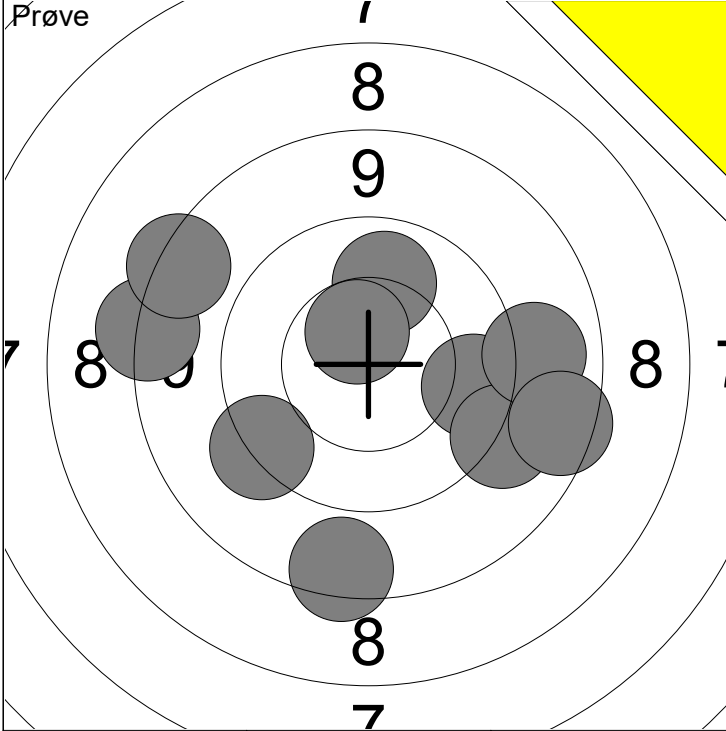

1: 9.8 →	6: 10.1 ↑
2: 9.3 ↘	7: 8.7 ↓
3: 9.1 →	8: 8.7 →
4: 8.5 ←	9: 10.6x ↑
5: 8.6 ↗	10: 9.5 ↙

Serie	88 (1x)
Total	0 (0x)

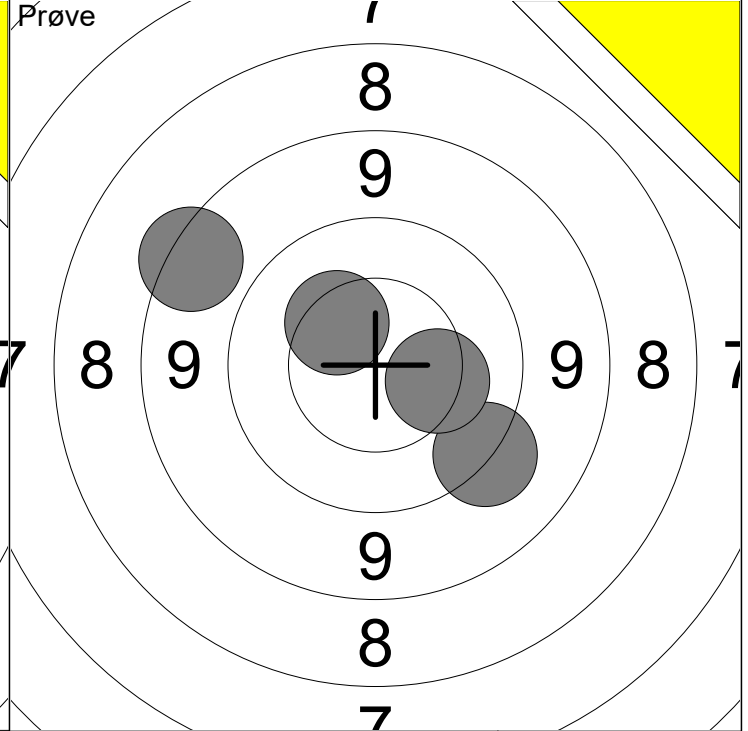

11: 9.4 ↘	12: 10.3 →
13: 8.6 ↗	14: 10.3 ↗

Serie	37 (0x)
Total	0 (0x)

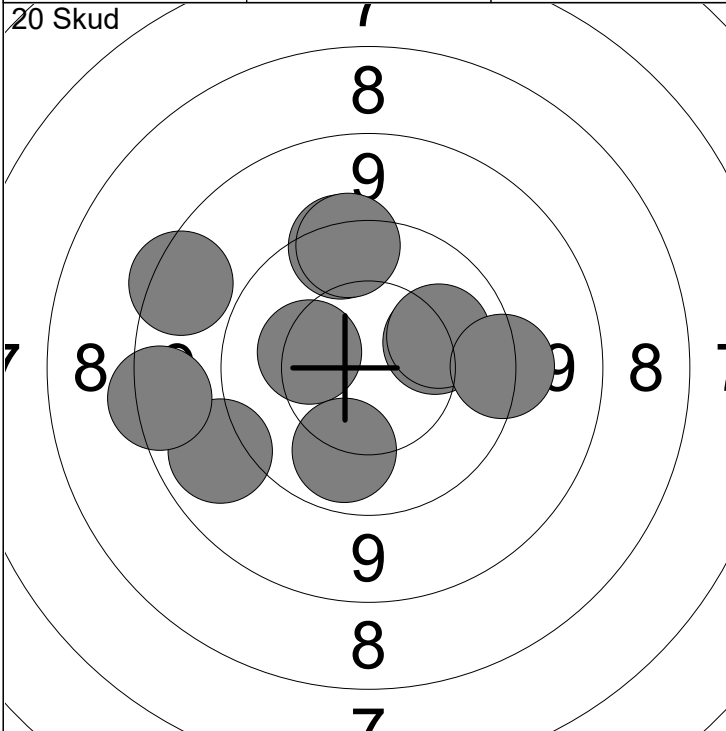

1: 10.2 →	6: 10.0 ↓
2: 10.3 ←	7: 8.7 ←
3: 10.1 →	8: 8.6 ←
4: 9.1 ←	9: 9.6 ↑
5: 9.5 →	10: 9.6 ↑

Serie	92 (0x)
Total	92 (0x)

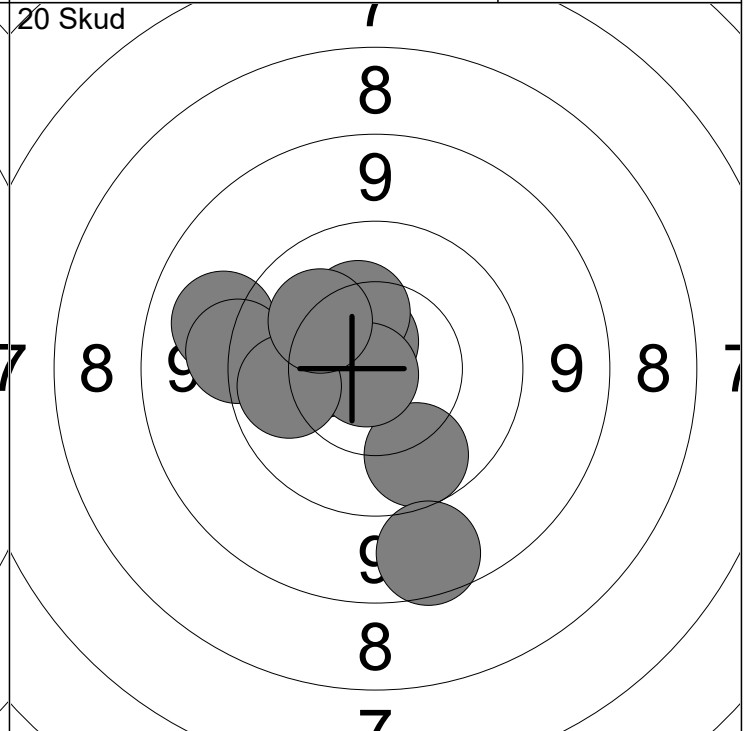

11: 10.0 ↓	12: 10.7x ↗	16: 10.4 ←
13: 9.2 ←	14: 9.4 ←	17: 8.8 ↓
15: 10.3 ↑	18: 10.8x ↘	19: 10.0 ←
	20: 10.2 ↙	

Serie	96 (2x)
Total	188 (2x)