

Hold 2	Skive 1	Simone misfeldt Kvist-Andersen	
50M		Ganløse Skytteforening	Å2
10.08.2024		EM 2024	Hanebjerg Skyttecenter
Kommentar		Signatur	

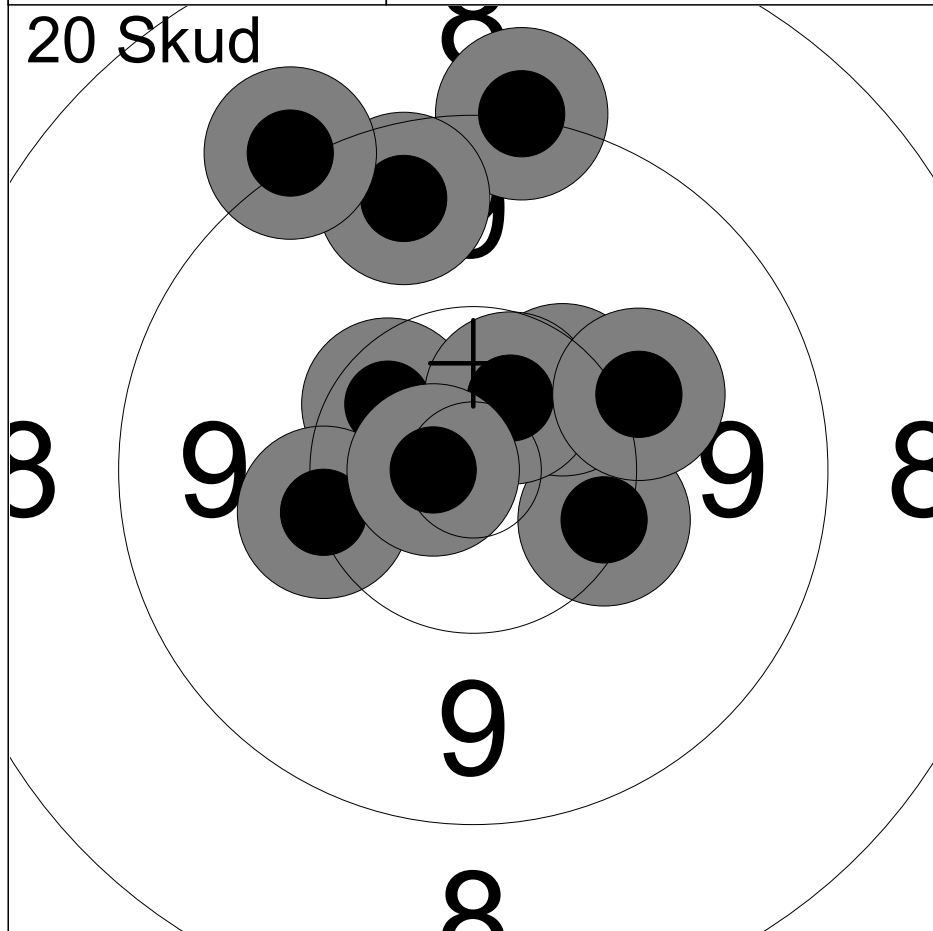

1:	10.4x	↖
2:	10.3	→
3:	9.1	↑
4:	10.4	↗
5:	10.6x	↗
6:	9.6	↑
7:	9.1	↖
8:	10.2	←
9:	10.1	↗
10:	10.8x	←
Serie		97 (3x)
Total		97 (3x)

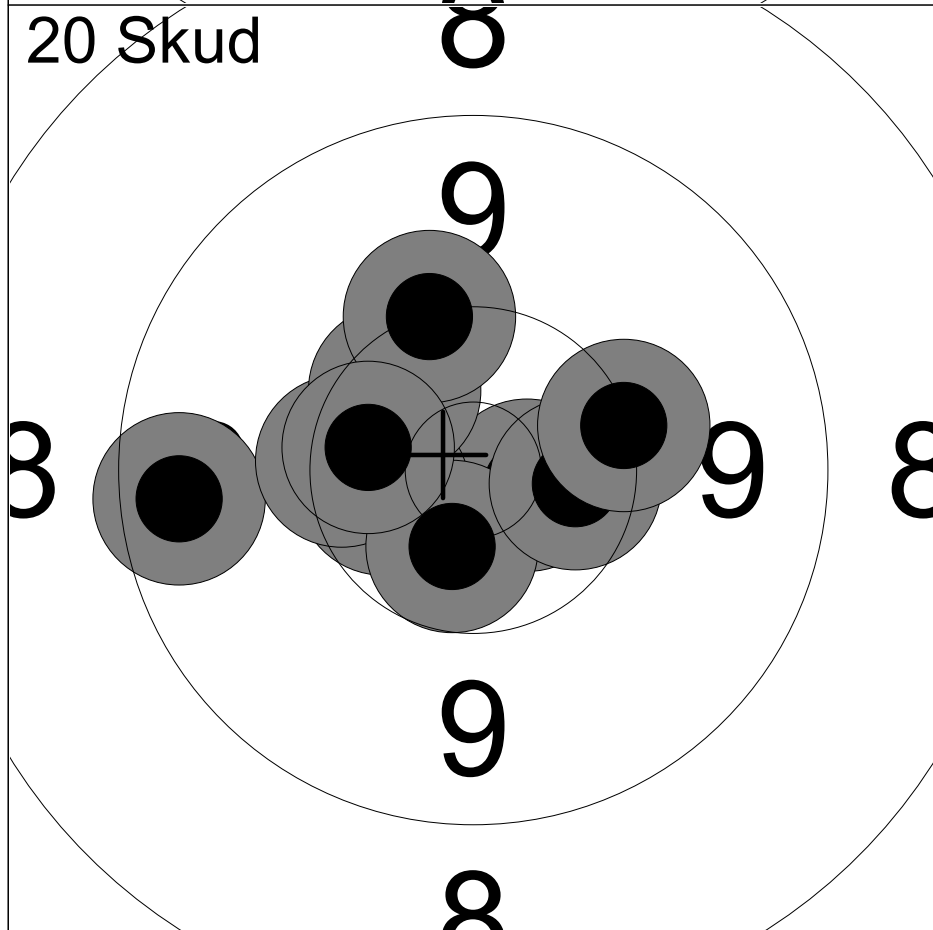

11:	10.7x	→
12:	9.5	←
13:	10.5x	←
14:	10.3	←
15:	10.6x	↘
16:	10.4	↗
17:	10.2	↑
18:	10.4x	→
19:	10.4x	←
20:	10.2	→
Serie		99 (5x)
Total		196 (8x)

Hold 2	Skive 2	Stefan Misfeldt Kvist-Andersen	
50M	Ganløse Skytteforening	Å1	
10.08.2024	EM 2024	Hanebjerg Skyttecenter	
Kommentar	Signatur		

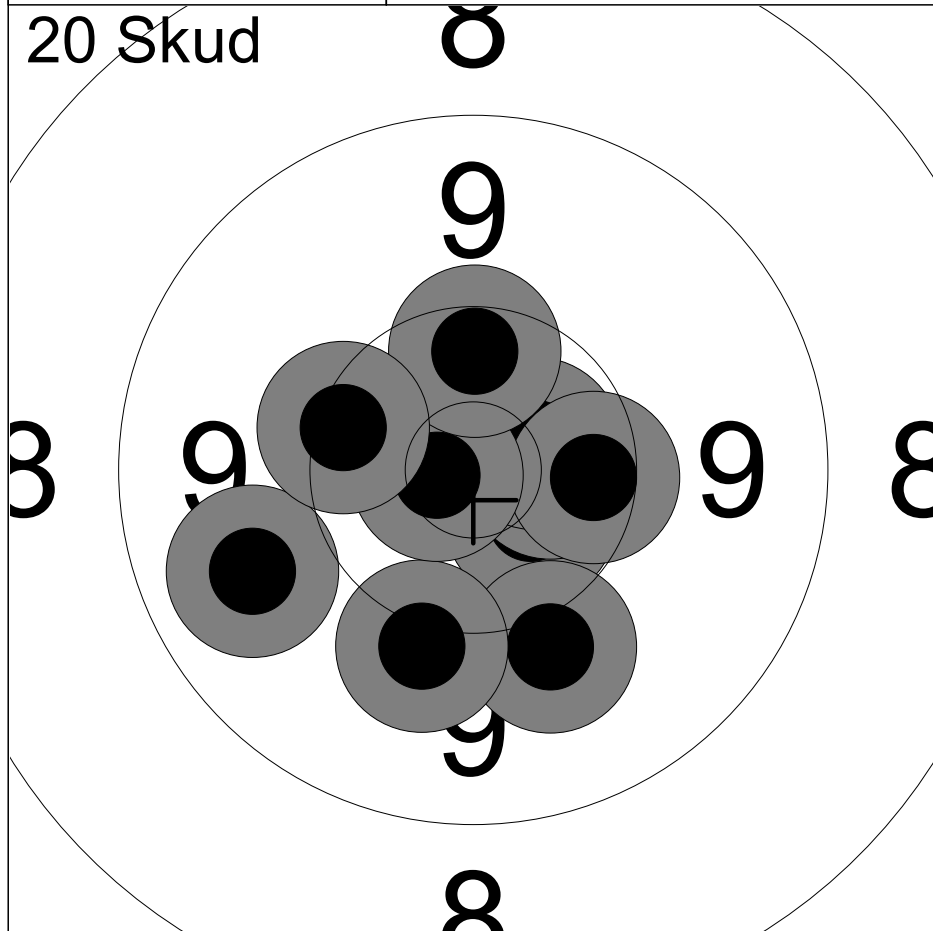

1:	10.6x	↘
2:	10.6x	→
3:	10.0	↘
4:	10.1	↘
5:	10.6x	↗
6:	9.8	←
7:	10.4	→
8:	10.8x	←
9:	10.4	↑
10:	10.3	←
Serie		99 (4x)
Total		99 (4x)

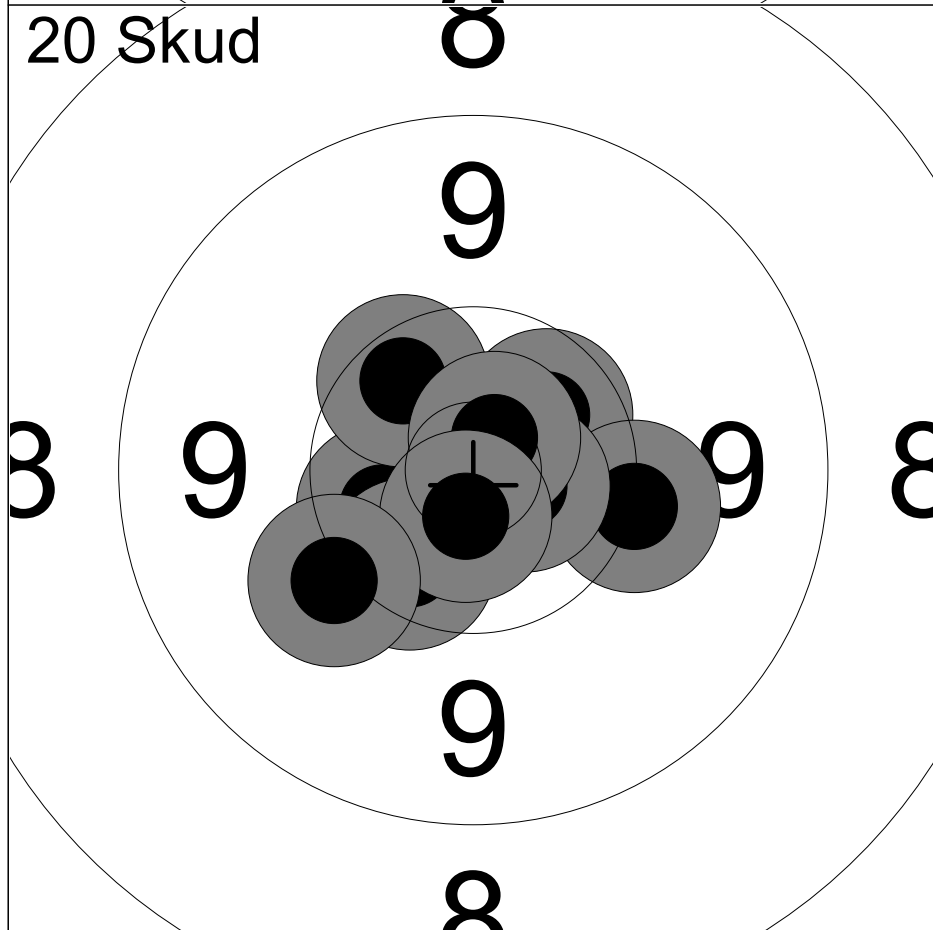

11:	10.5x	←
12:	10.7x	→
13:	10.5x	↗
14:	10.4	↘
15:	10.1	→
16:	10.7x	↗
17:	10.4	↗
18:	10.8x	↗
19:	10.7x	↘
20:	10.1	↘
Serie		100 (6x)
Total		199 (10x)

Hold 2	Skive 5	Jonas Keiding		
50M		Kreds 57, Ferslev, Skibby		J2
10.08.2024		EM 2024		Hanebjerg Skyttecenter
Kommentar		Signatur		

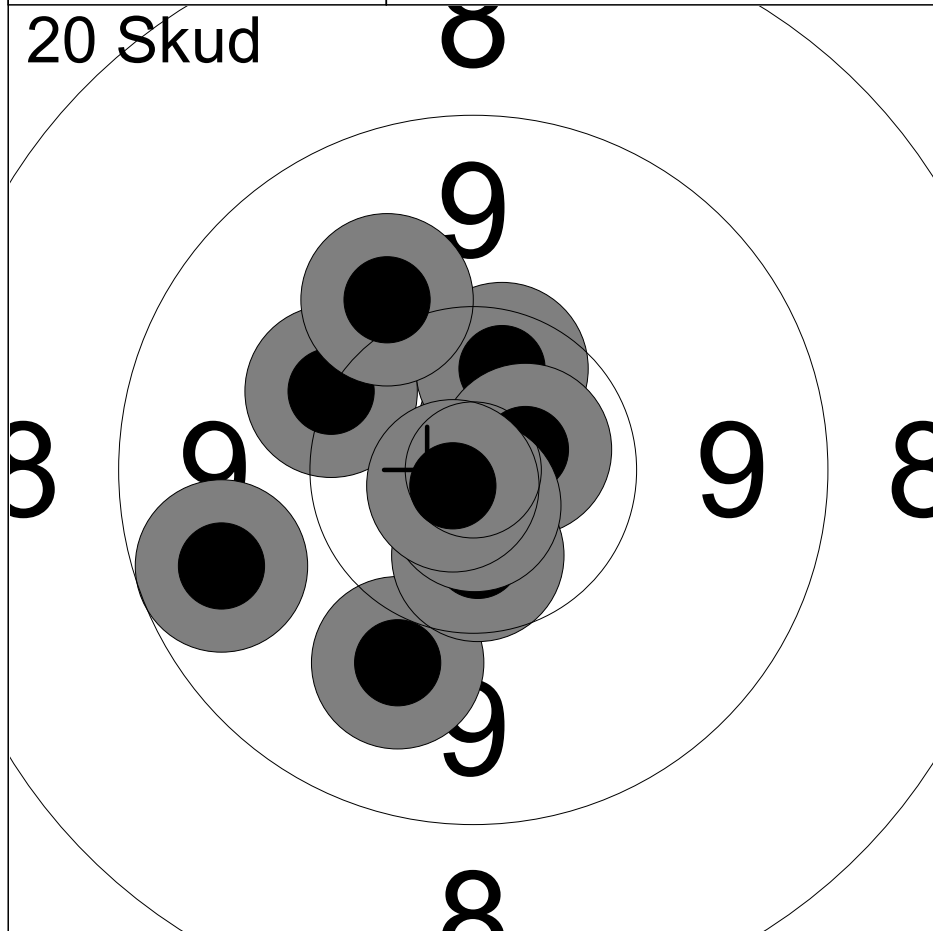

1:	10.7x	↗
2:	10.4x	↑
3:	9.6	↖
4:	10.7x	↗
5:	9.9	↘
6:	10.2	↖
7:	10.5x	↓
8:	10.8x	↓
9:	10.8x	↖
10:	10.0	↖
Serie		98 (6x)
Total		98 (6x)

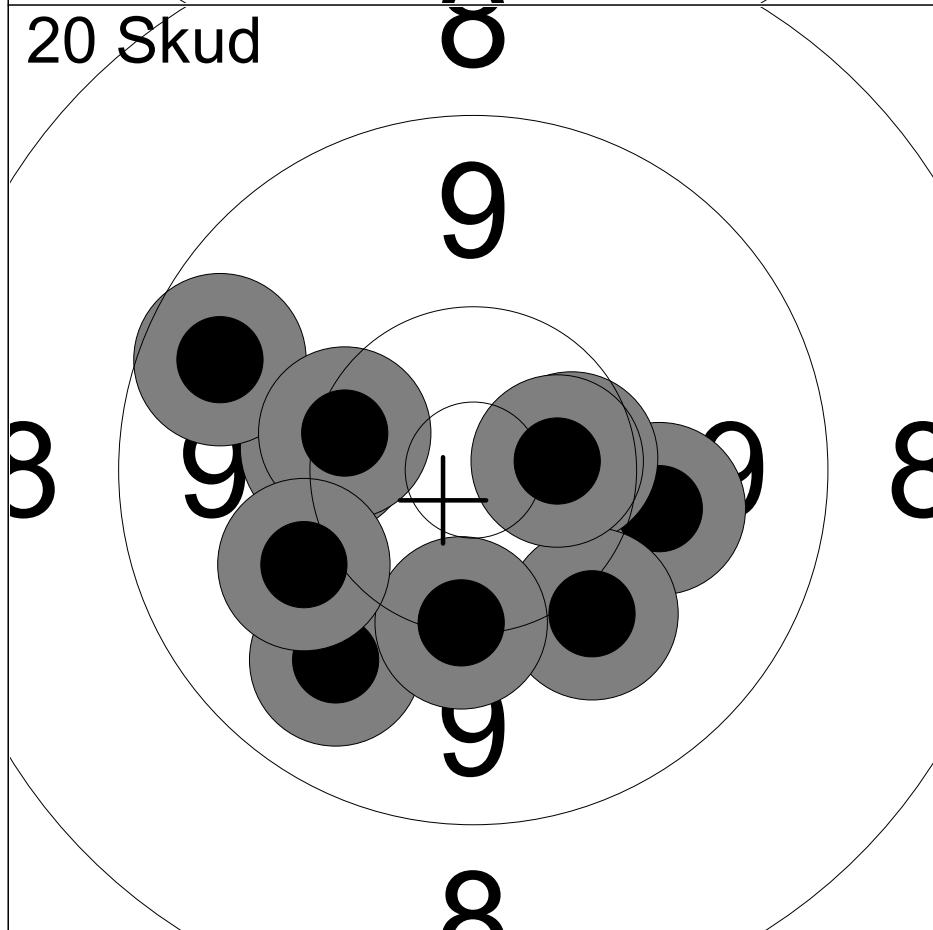

11:	10.0	→
12:	10.2	↖
13:	10.5x	→
14:	9.6	↖
15:	10.0	↘
16:	9.8	↖
17:	10.2	↓
18:	10.3	↖
19:	10.5x	→
20:	10.0	↖
Serie		98 (2x)
Total		196 (8x)

Hold 3	Skive 2	Stine Kongsted	
50M	Frederikssund Skytteforening, I	Å1	
10.08.2024	EM 2024	Hanebjerg Skyttecenter	
Kommentar	Signatur		

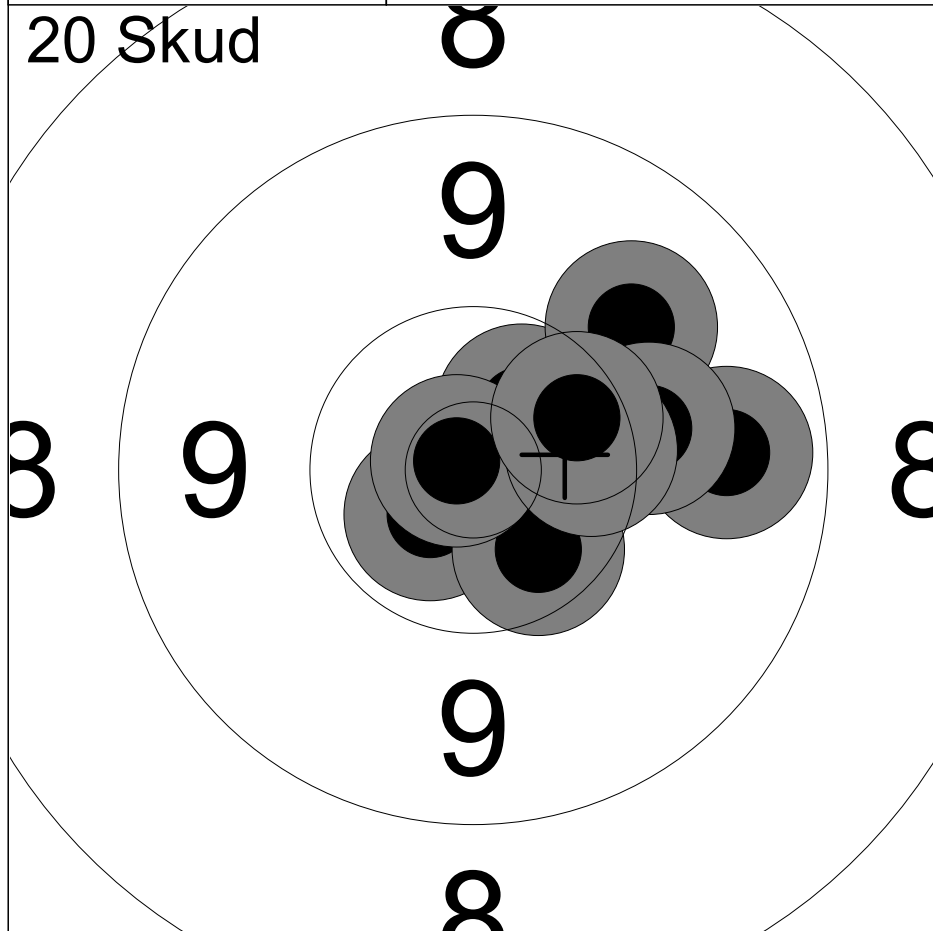

1:	10.6x	↙
2:	10.6x	↗
3:	10.5x	↘
4:	9.7	→
5:	10.9x	↖
6:	10.2	↗
7:	9.9	↗
8:	10.1	→
9:	10.4	→
10:	10.4	↗
Serie		98 (4x)
Total		98 (4x)

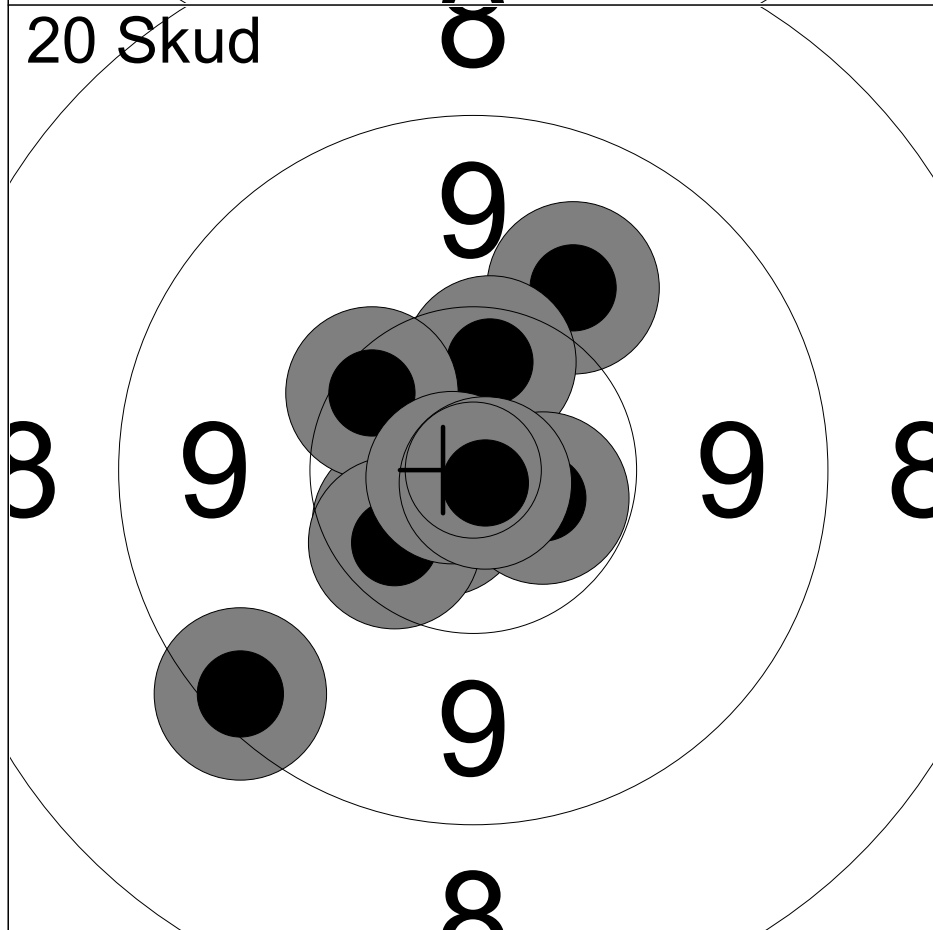

11:	9.9	↗
12:	10.5x	↙
13:	10.4x	↑
14:	10.3	↖
15:	10.7x	↙
16:	10.4x	↙
17:	10.8x	↙
18:	10.6x	→
19:	9.3	↙
20:	10.9x	↘
Serie		98 (7x)
Total		196 (11x)

Hold 3	Skive 6	Elias Hold Moerkenborg	
50M	Frederikssund Skytteforening, I	BK1	
10.08.2024	EM 2024	Hanebjerg Skyttecenter	
Kommentar	Signatur		

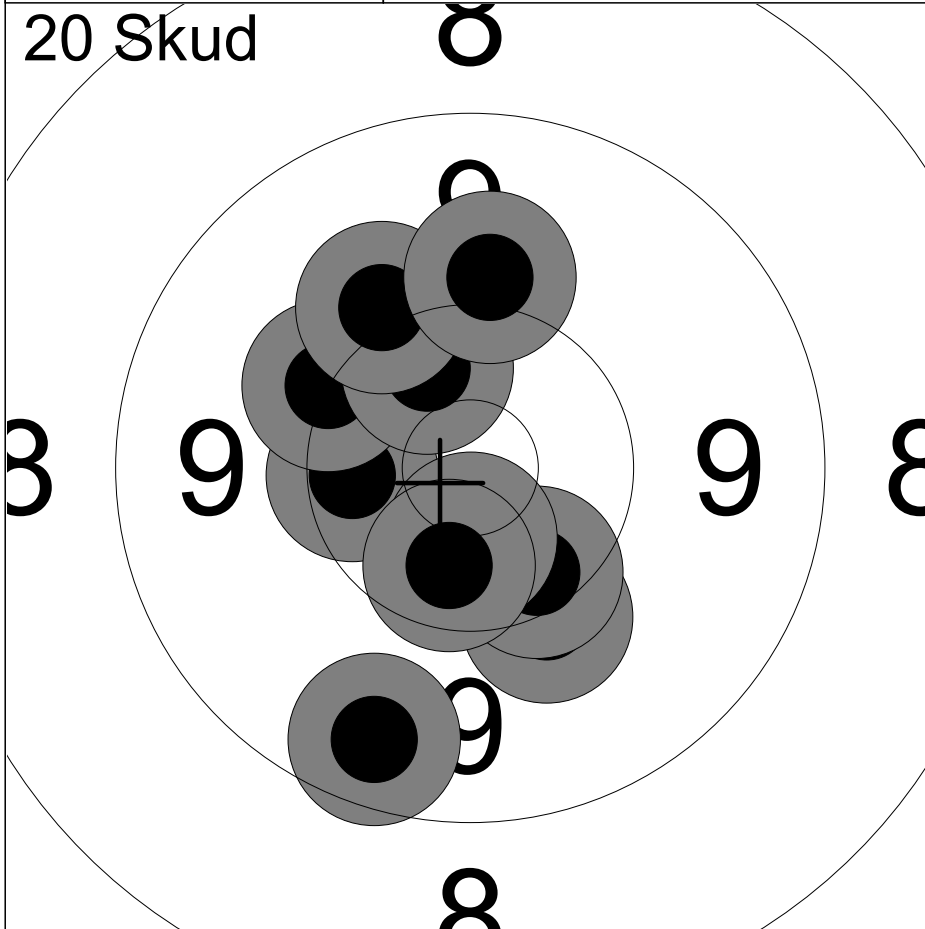

1:	9.5	↘
2:	10.4	←
3:	10.1	↘
4:	10.3	↘
5:	10.6x	↓
6:	10.2	↗
7:	10.5x	↘
8:	10.4x	↗
9:	10.1	↗
10:	10.0	↑
Serie		99 (3x)
Total		99 (3x)

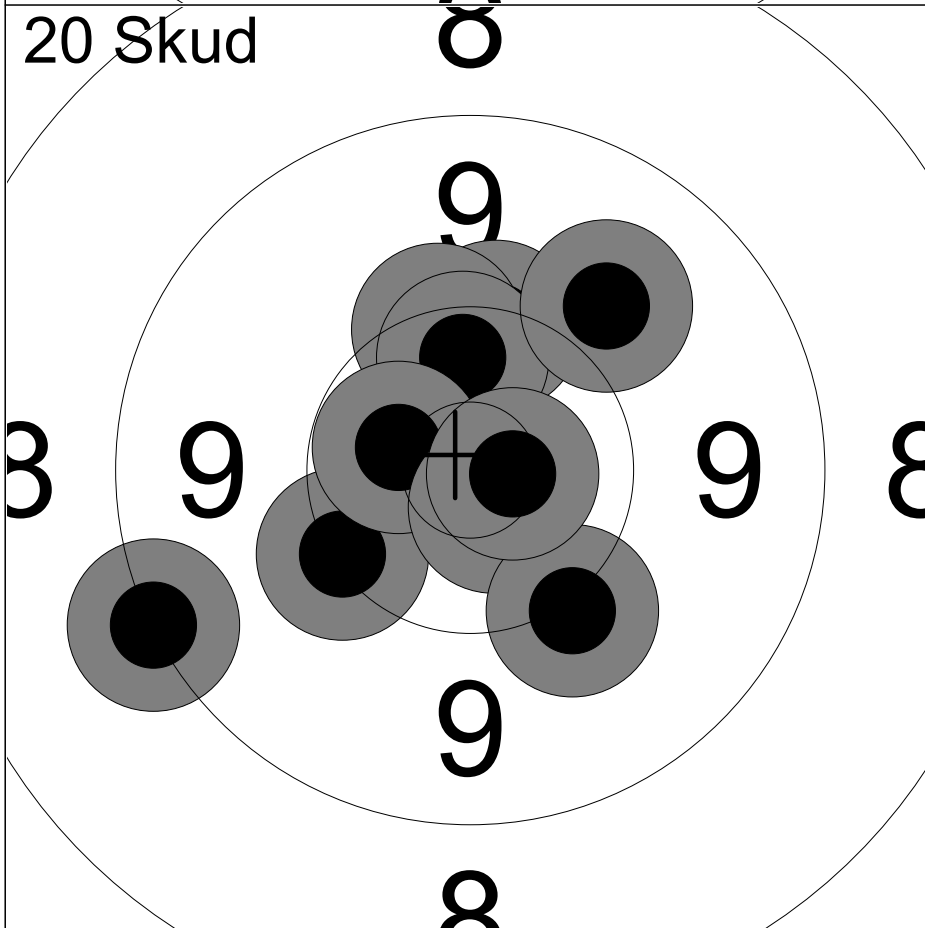

11:	10.2	↑
12:	10.3	↑
13:	9.2	↙
14:	10.4	↑
15:	10.2	↙
16:	10.6x	↙
17:	10.7x	↘
18:	10.1	↘
19:	10.7x	→
20:	9.9	↗
Serie		98 (3x)
Total		197 (6x)

Hold 3	Skive 12	Erik Nissen	
50M		Frederikssund Skytteforening, I	BK1
10.08.2024		EM 2024	Hanebjerg Skyttecenter
Kommentar		Signatur	

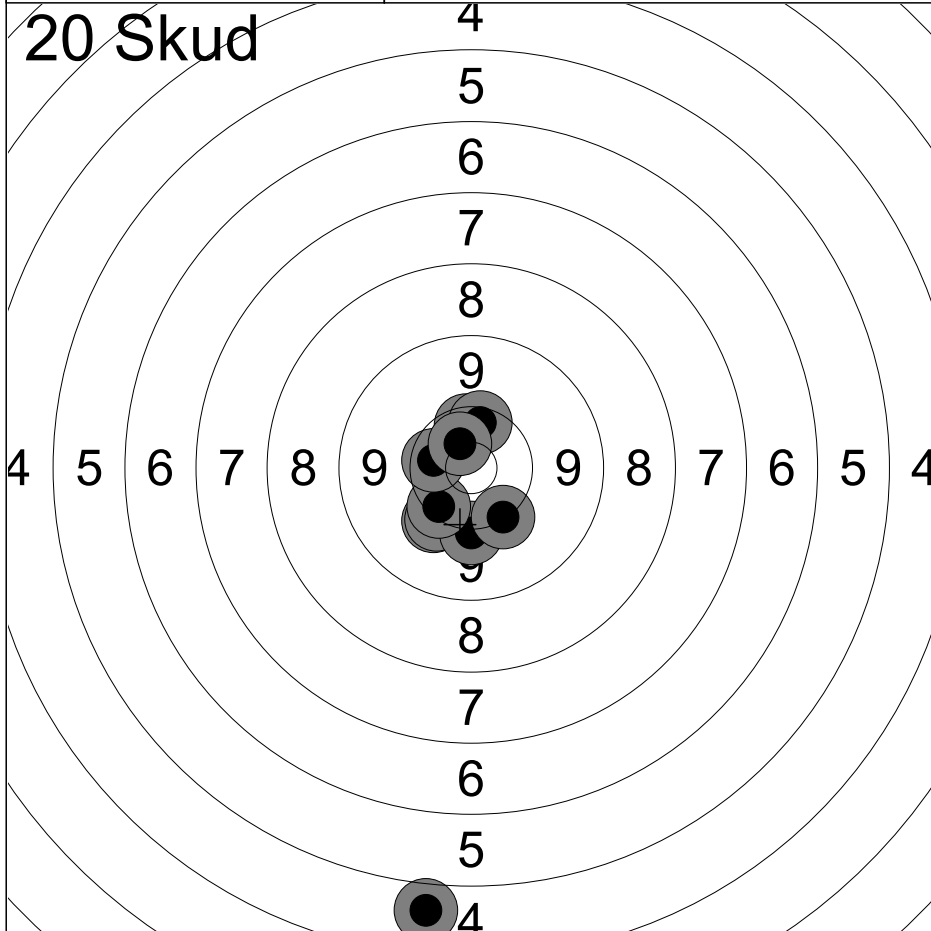

1:	10.1	↘
2:	10.1	↘
3:	10.1	↓
4:	10.3	↘
5:	10.5x	←
6:	10.4	↑
7:	4.8	↓
8:	10.3	↑
9:	10.2	↘
10:	10.6x	↗
Serie		94 (2x)
Total		94 (2x)

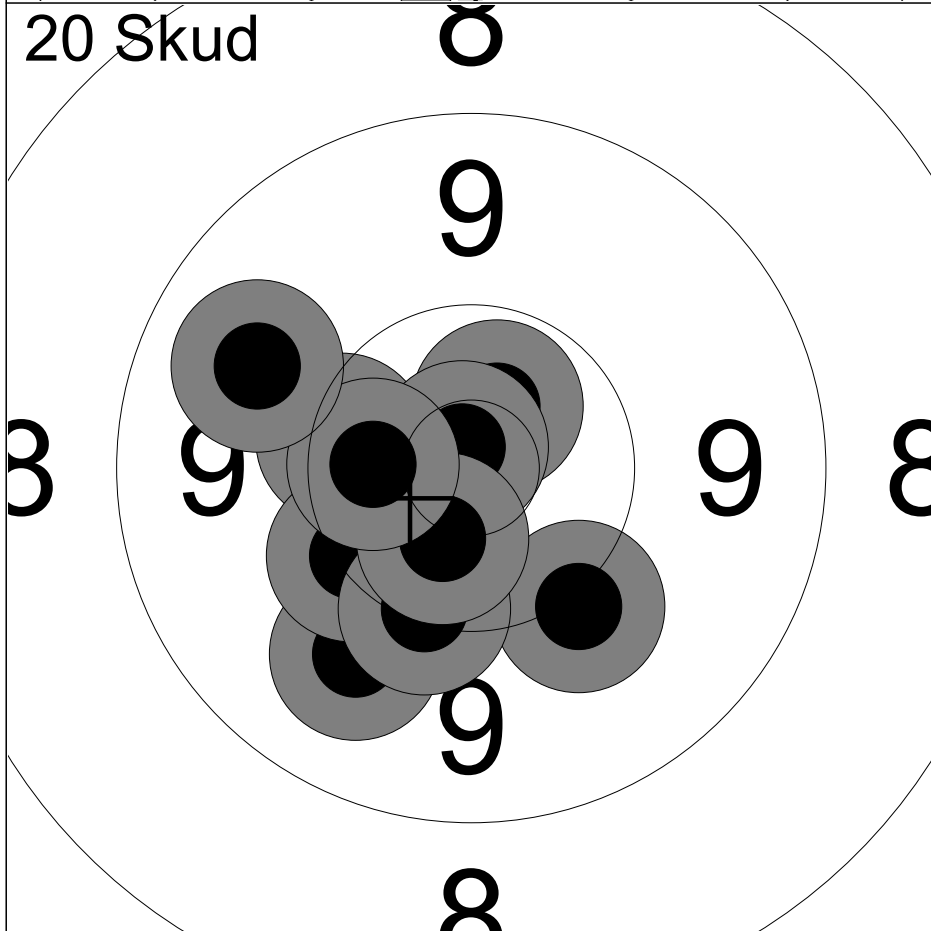

11:	9.9	↘
12:	10.3	←
13:	10.6x	↗
14:	10.2	↘
15:	10.8x	↗
16:	10.1	↘
17:	10.2	↓
18:	10.6x	↘
19:	10.5x	←
20:	9.8	↖
Serie		98 (4x)
Total		192 (6x)

Hold 4	Skive 1	Simone misfeldt Kvist-Andersen	
50M		Ganløse Skytteforening	MÅ2
10.08.2024		EM 2024	Hanebjerg Skyttecenter
Kommentar		Signatur	

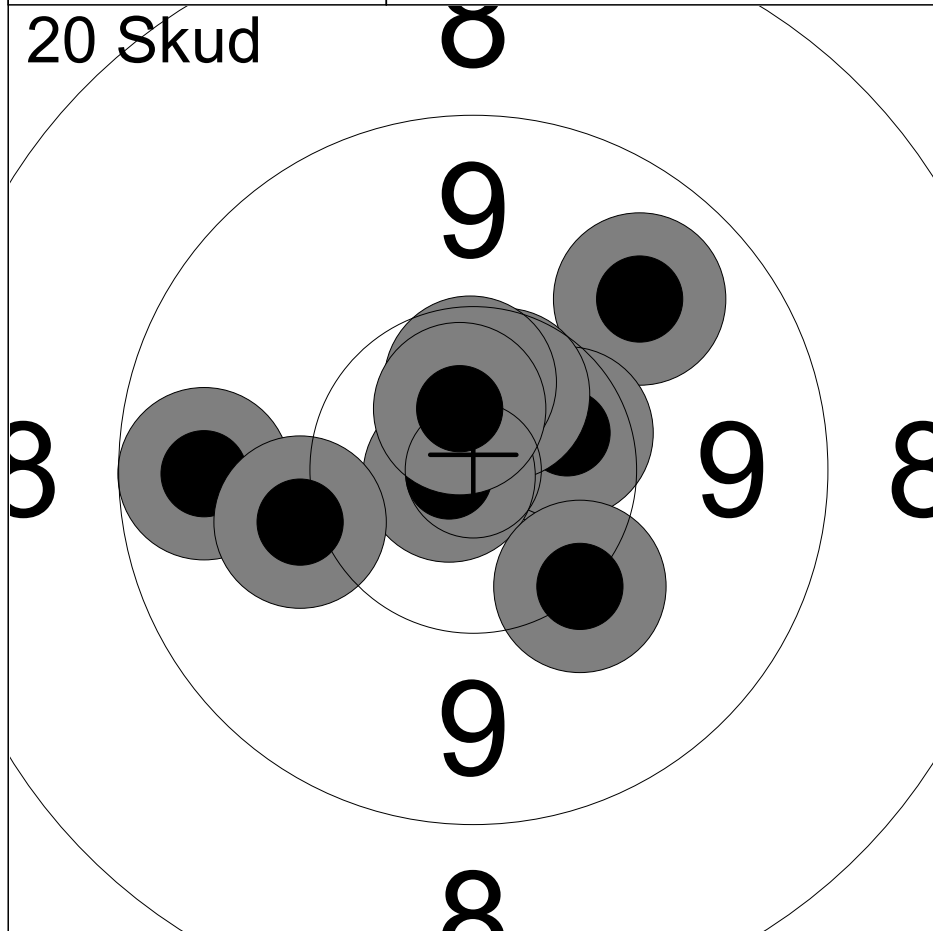

1:	10.5x	➔
2:	9.8	↗
3:	10.5x	➔
4:	10.6x	↗
5:	10.8x	↙
6:	9.6	↙
7:	10.1	↙
8:	10.5x	↗
9:	10.2	↘
10:	10.6x	↗
Serie		98 (6x)
Total		98 (6x)



11:	10.4	↙
12:	10.3	↗
13:	10.4	↗
14:	10.3	➔
15:	9.8	↙
16:	10.0	↘
17:	10.2	↘
18:	10.5x	↘
19:	10.0	↗
20:	10.1	↗
Serie		99 (1x)
Total		197 (7x)

Hold 4	Skive 2	Stefan Misfeldt Kvist-Andersen	
50M	Ganløse Skytteforening	MÅ1	
10.08.2024	EM 2024	Hanebjerg Skyttecenter	
Kommentar	Signatur		

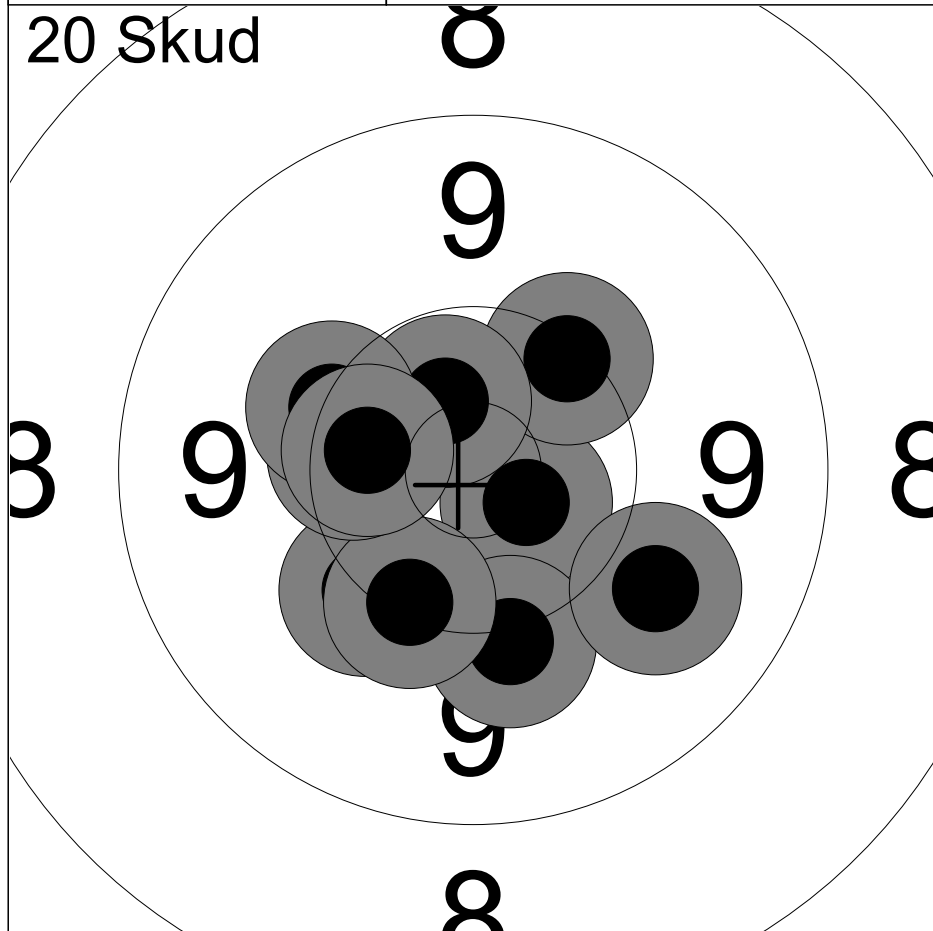

1:	10.6x	↘
2:	10.1	↓
3:	10.2	↙
4:	10.2	↗
5:	10.2	↙
6:	10.6x	↗
7:	10.4	←
8:	10.2	↗
9:	9.9	↘
10:	10.4x	←
Serie		99 (3x)
Total		99 (3x)

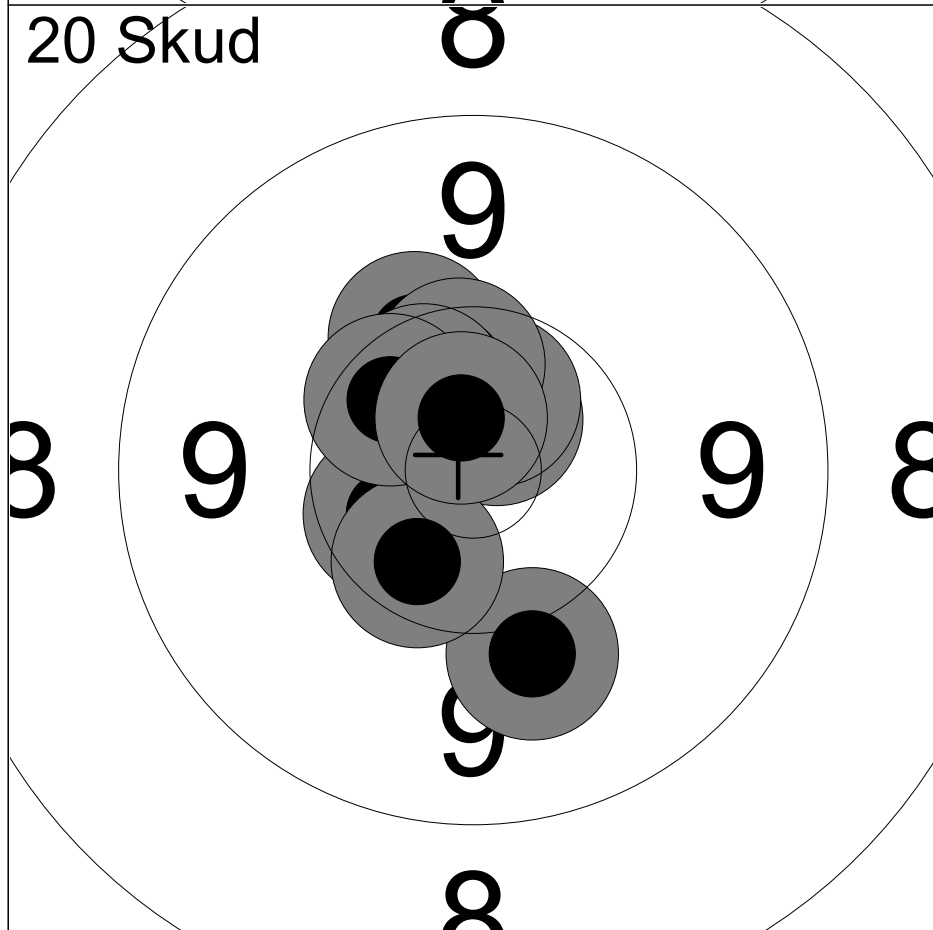

11:	10.2	↗
12:	10.5x	↙
13:	10.7x	↗
14:	10.6x	↗
15:	10.4x	↑
16:	10.0	↓
17:	10.4x	↙
18:	10.5x	↗
19:	10.4x	↗
20:	10.7x	↗
Serie		100 (8x)
Total		199 (11x)

Hold 4	Skive 5	Jonas Keiding		
50M		Kreds 57, Ferslev, Skibby		MJ2
10.08.2024		EM 2024		Hanebjerg Skyttecenter
Kommentar		Signatur		

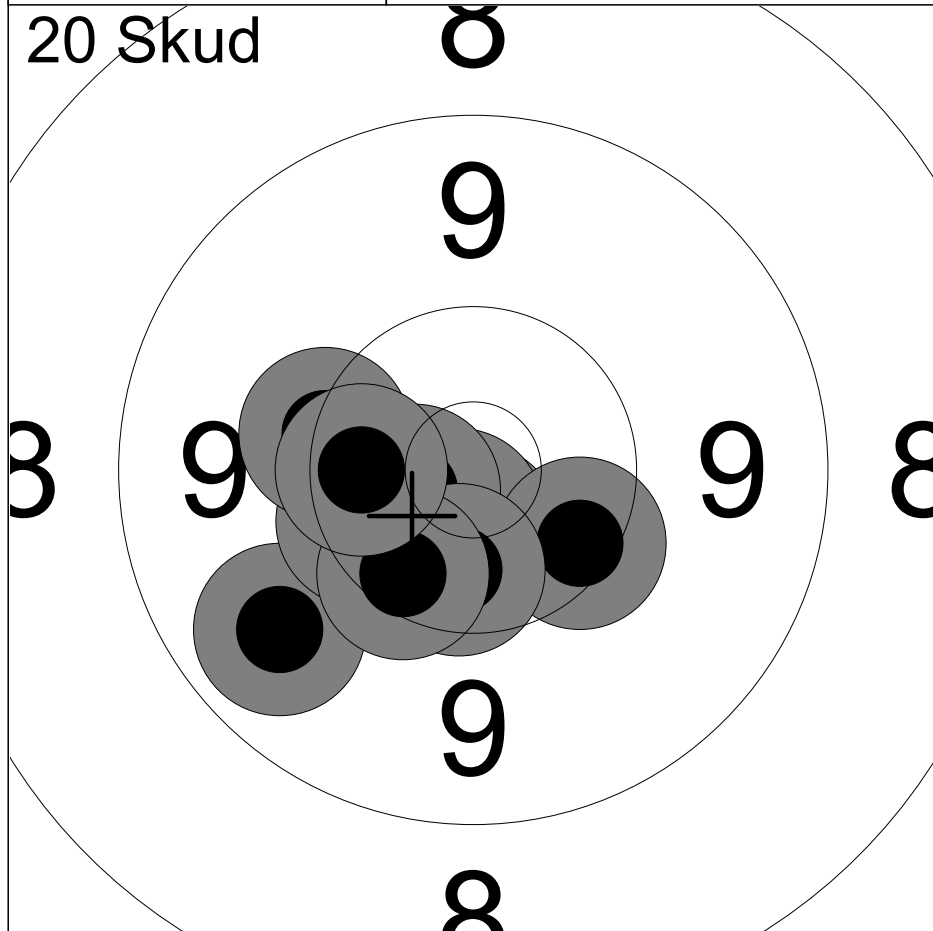

1:	10.7x	↓
2:	9.7	↙
3:	10.7x	↓
4:	10.6x	↙
5:	10.4	↙
6:	10.3	↘
7:	10.2	↙
8:	10.5x	↓
9:	10.3	↘
10:	10.4	↙
Serie		99 (4x)
Total		99 (4x)

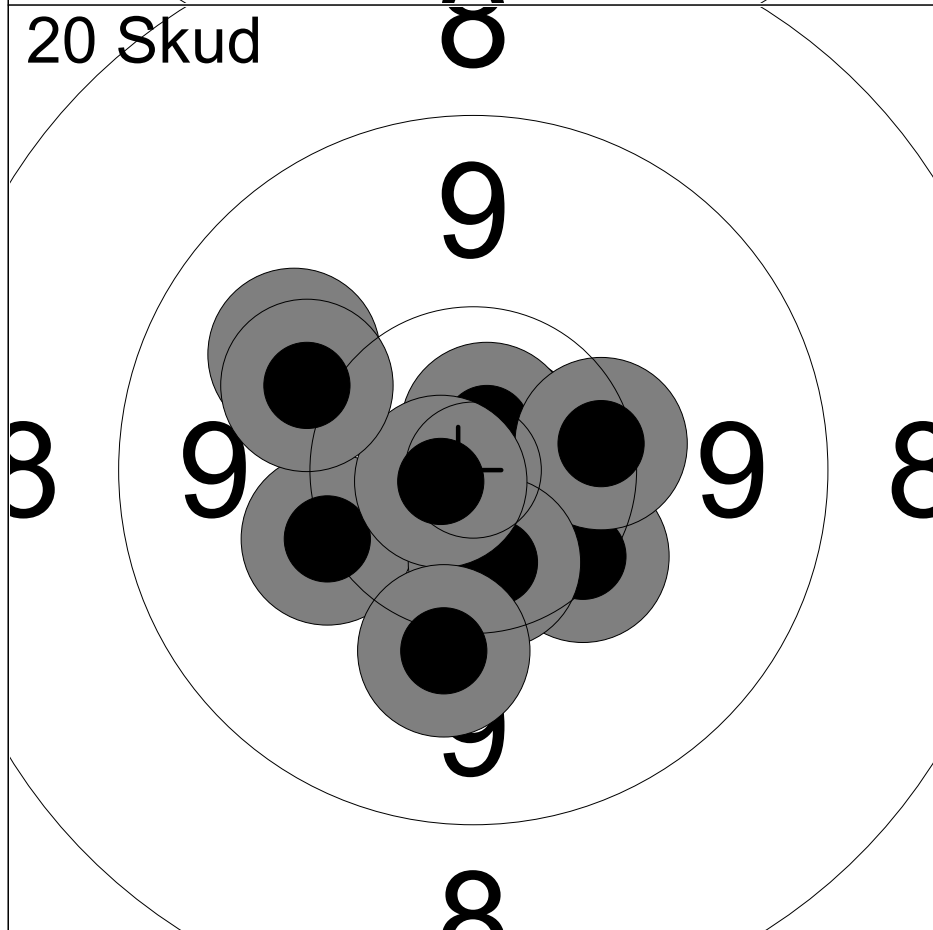

11:	10.2	↙
12:	9.9	↖
13:	10.8x	↗
14:	10.3	↘
15:	10.7x	↗
16:	10.3	→
17:	10.5x	↓
18:	10.8x	↙
19:	10.1	↓
20:	10.0	↙
Serie		99 (4x)
Total		198 (8x)

Hold 4	Skive 12	Rasmus Andersen	
50M	Frederikssund Skytteforening, I	ST3	
10.08.2024	EM 2024	Hanebjerg Skyttecenter	
Kommentar	Signatur		

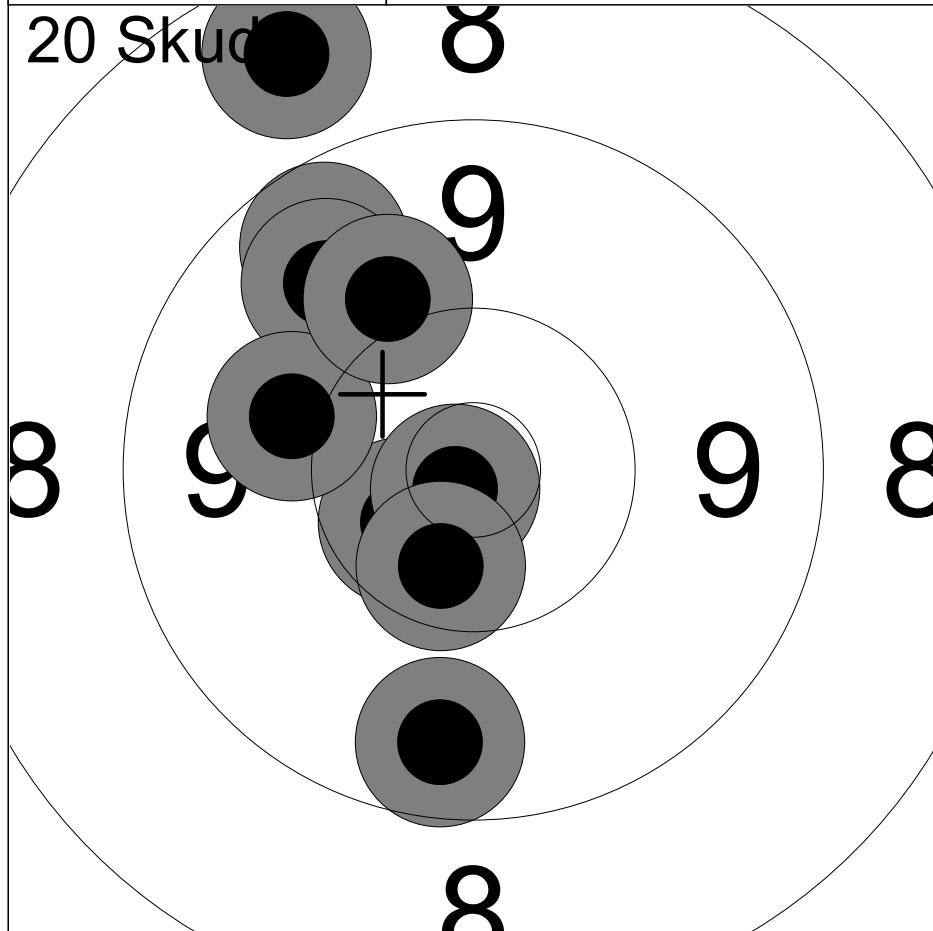

1:	10.5x	↙
2:	9.8	↗
3:	8.6	↗
4:	10.8x	↙
5:	10.5x	↘
6:	9.6	↗
7:	9.8	↗
8:	10.0	↖
9:	10.0	↗
10:	9.6	↘

Serie	94 (3x)
Total	94 (3x)

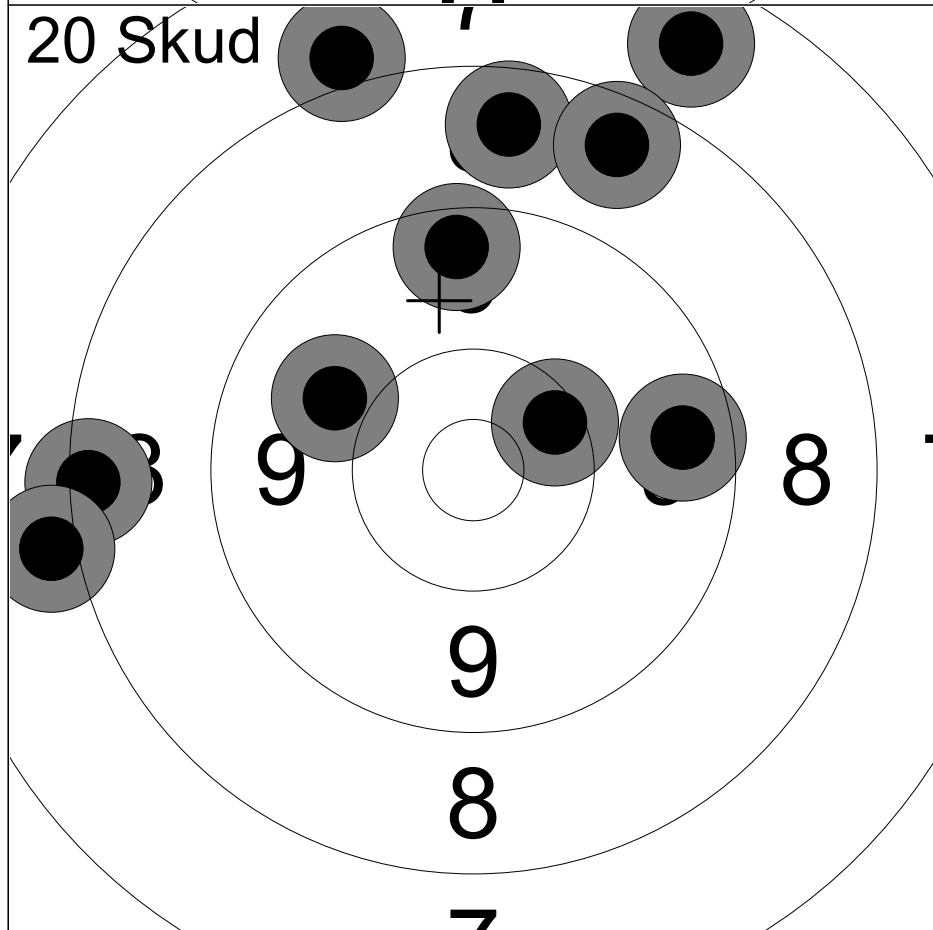

11:	8.3	←
12:	8.6	↑
13:	9.4	↑
14:	9.5	→
15:	10.3	↗
16:	7.6	↗
17:	8.0	←
18:	9.9	↖
19:	8.0	↗
20:	8.5	↗

Serie	84 (0x)
Total	178 (3x)

Hold 5	Skive 2	Stine Kongsted	
50M	Frederikssund Skytteforening, I	MÅ1	
10.08.2024	EM 2024	Hanebjerg Skyttecenter	
Kommentar	Signatur		



1:	10.4x	↗
2:	10.8x	↖
3:	10.4	↘
4:	10.5x	↖
5:	10.5x	↘
6:	10.0	↘
7:	10.6x	↘
8:	10.2	↗
9:	10.5x	↗
10:	10.6x	↘
Serie		100 (7x)
Total		100 (7x)

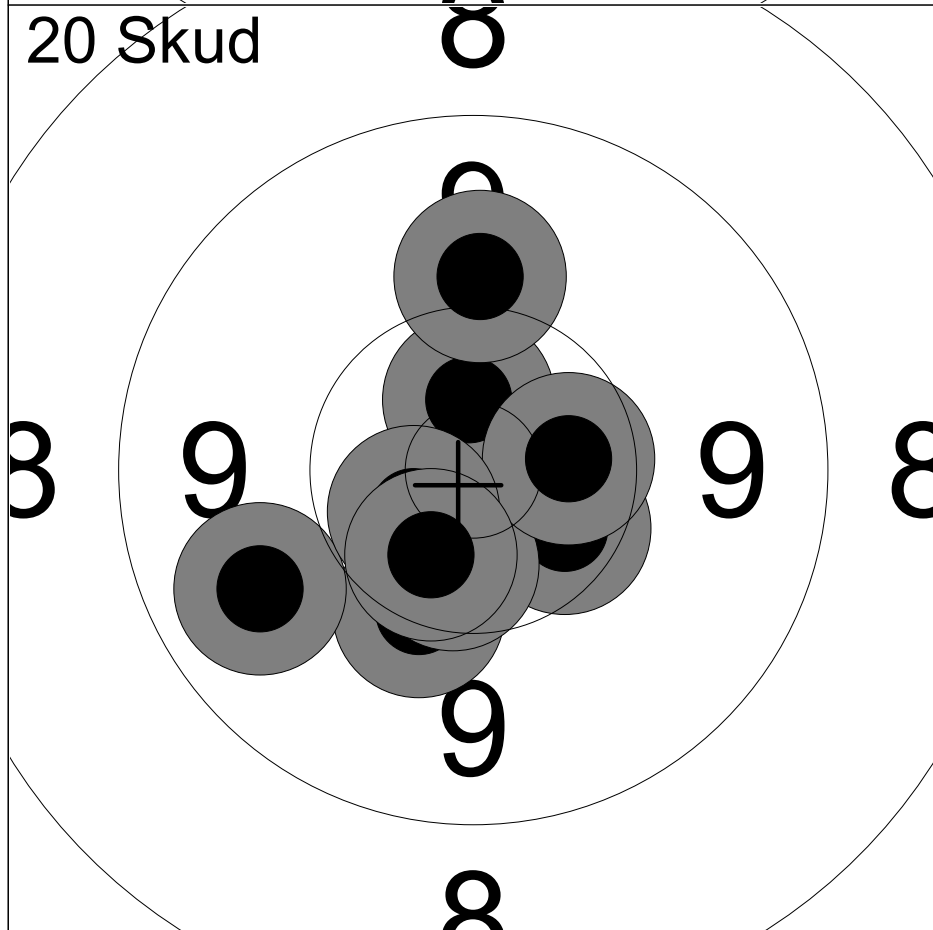

11:	10.2	↘
12:	10.8x	↖
13:	10.4x	↘
14:	9.8	↖
15:	10.6x	↗
16:	10.5x	↘
17:	10.5x	→
18:	10.6x	↖
19:	10.5x	↘
20:	10.0	↗
Serie		99 (7x)
Total		199 (14x)

Hold 5	Skive 6	Elias Hold Moerkenborg	
50M	Frederikssund Skytteforening, I	MBK1	
10.08.2024	EM 2024	Hanebjerg Skyttecenter	
Kommentar	Signatur		

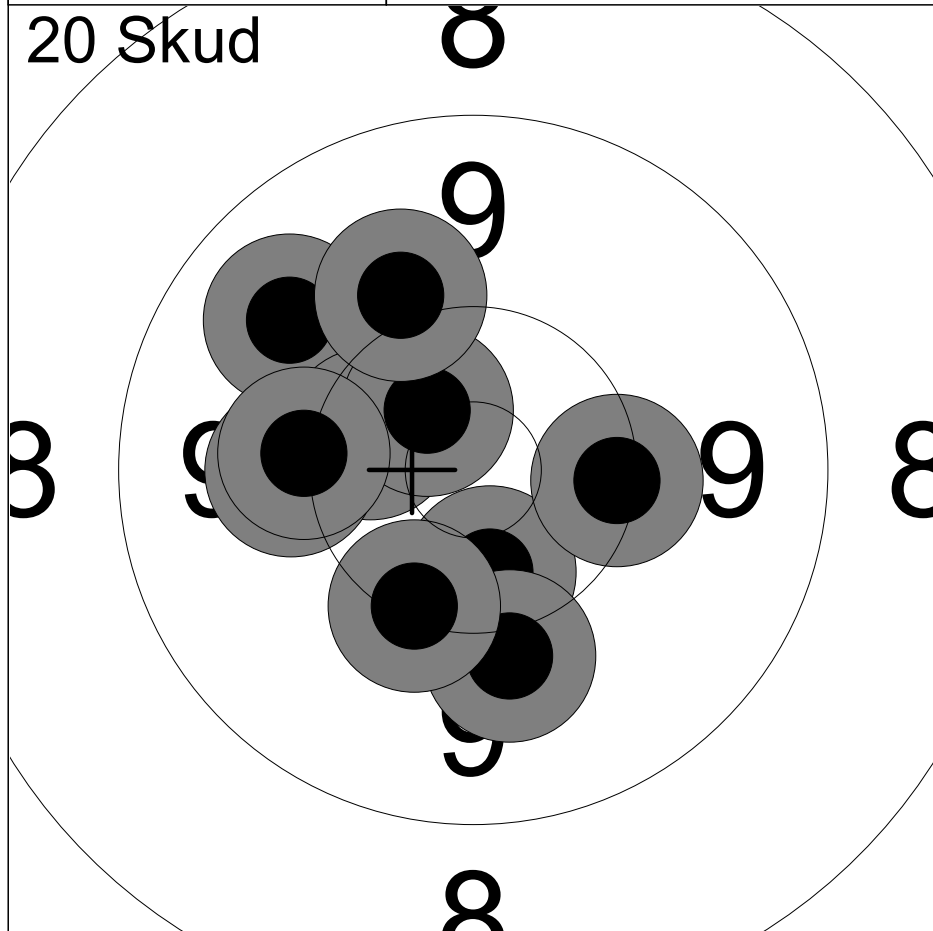

1:	9.8	↗
2:	10.4x	↘
3:	10.0	↘
4:	10.2	↘
5:	10.4x	↖
6:	10.3	→
7:	10.6x	↗
8:	10.0	↗
9:	10.1	←
10:	10.1	←
Serie		99 (3x)
Total		99 (3x)

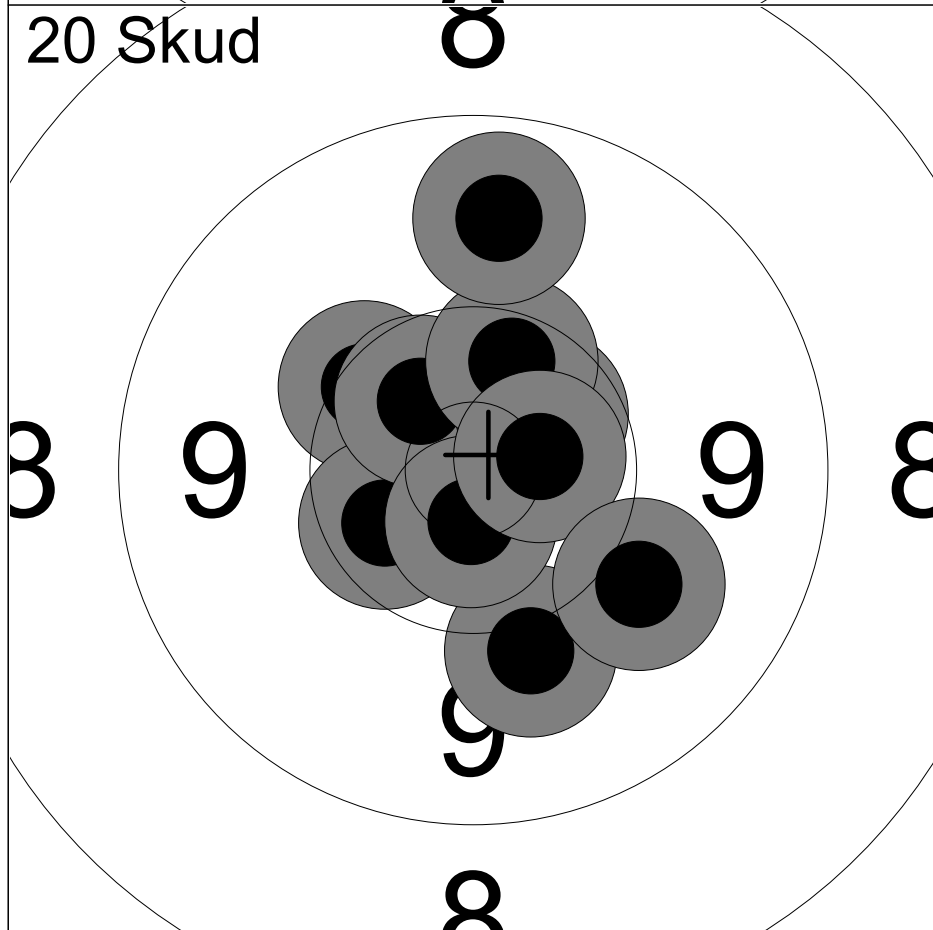

11:	10.0	↘
12:	10.3	↗
13:	10.4x	↖
14:	10.5x	↗
15:	10.5x	↗
16:	10.7x	↘
17:	10.4	↗
18:	9.7	↗
19:	10.6x	→
20:	10.0	↘
Serie		99 (5x)
Total		198 (8x)

Hold 5	Skive 12	Erik Nissen		
50M		Frederikssund Skytteforening, I		MBK1
10.08.2024		EM 2024		Hanebjerg Skyttecenter
Kommentar		Signatur		

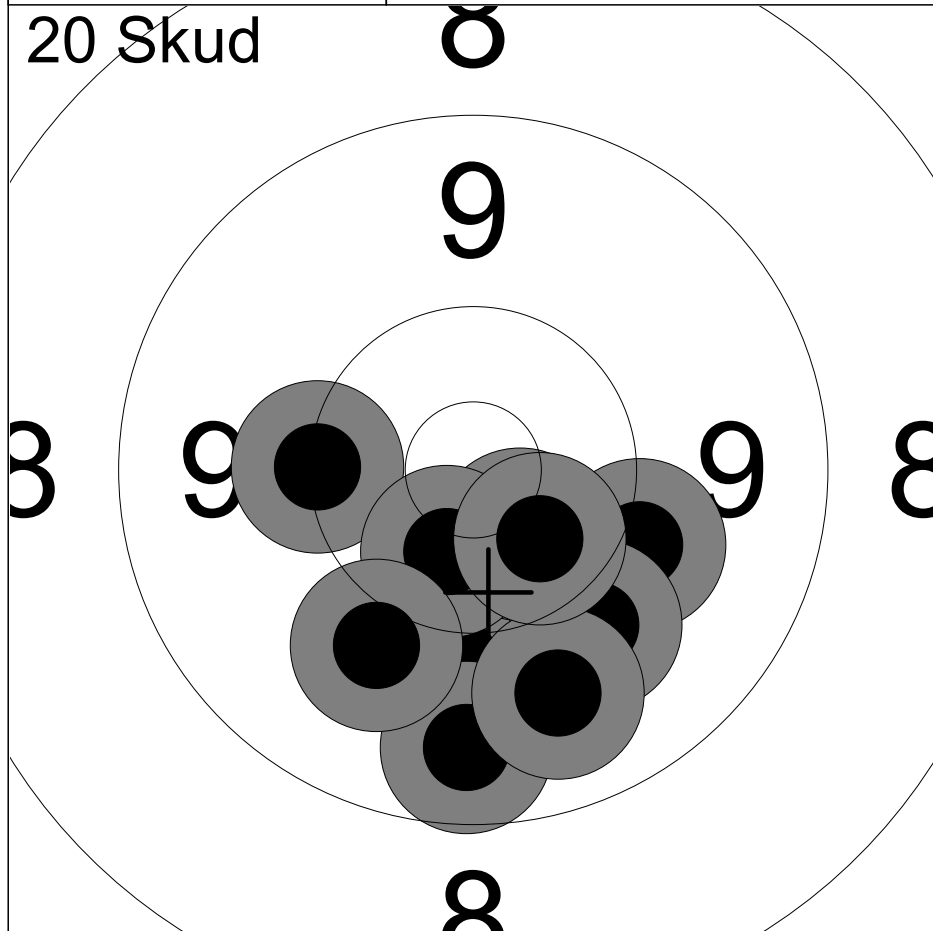

1:	10.0	↓
2:	10.6x	↘
3:	9.6	↓
4:	10.2	←
5:	10.1	↘
6:	10.0	↘
7:	10.5x	↘
8:	9.8	↘
9:	10.5x	↘
10:	10.0	↘
Serie		98 (3x)
Total		98 (3x)

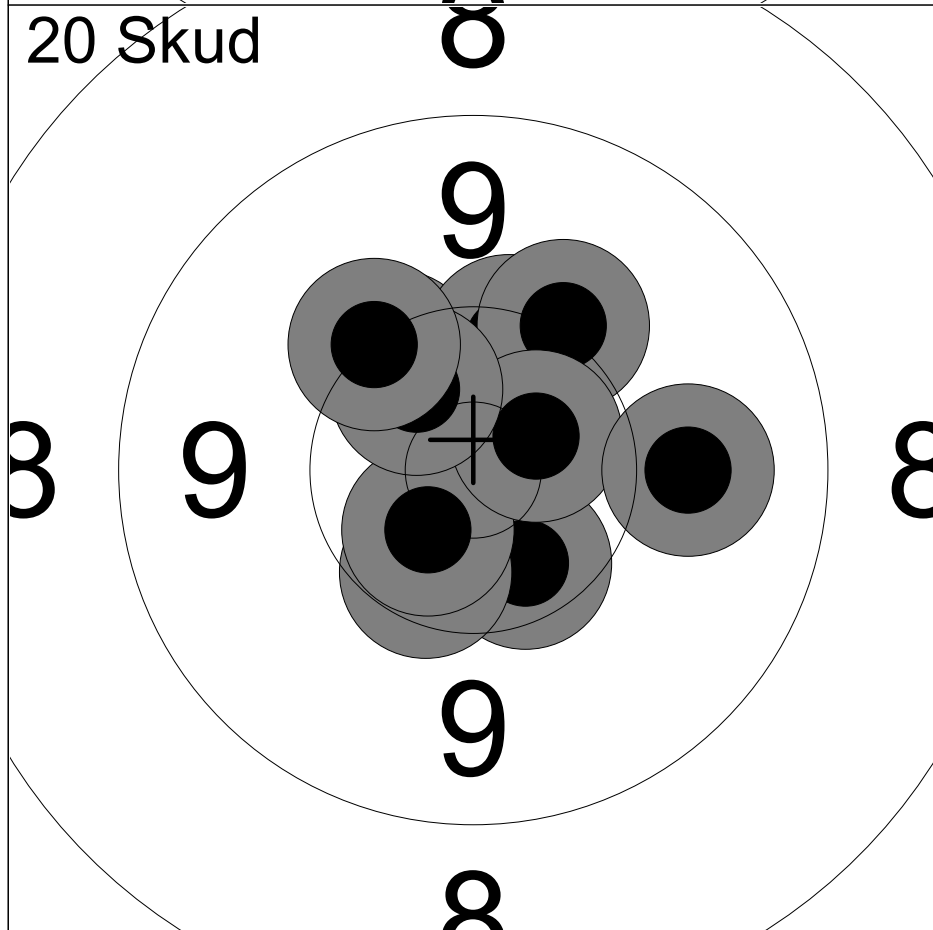

11:	10.4x	↘
12:	10.4	↘
13:	10.6x	↘
14:	10.3	↗
15:	10.3	↗
16:	10.1	↗
17:	10.6x	↗
18:	9.9	→
19:	10.5x	↗
20:	10.2	↗
Serie		99 (4x)
Total		197 (7x)

Hold 6	Skive 1	Clara M. Dahl		
50M		Ramløse Idrætsforening Skydning	BK3	
10.08.2024		EM 2024	Hanebjerg Skyttecenter	
Kommentar		Signatur		

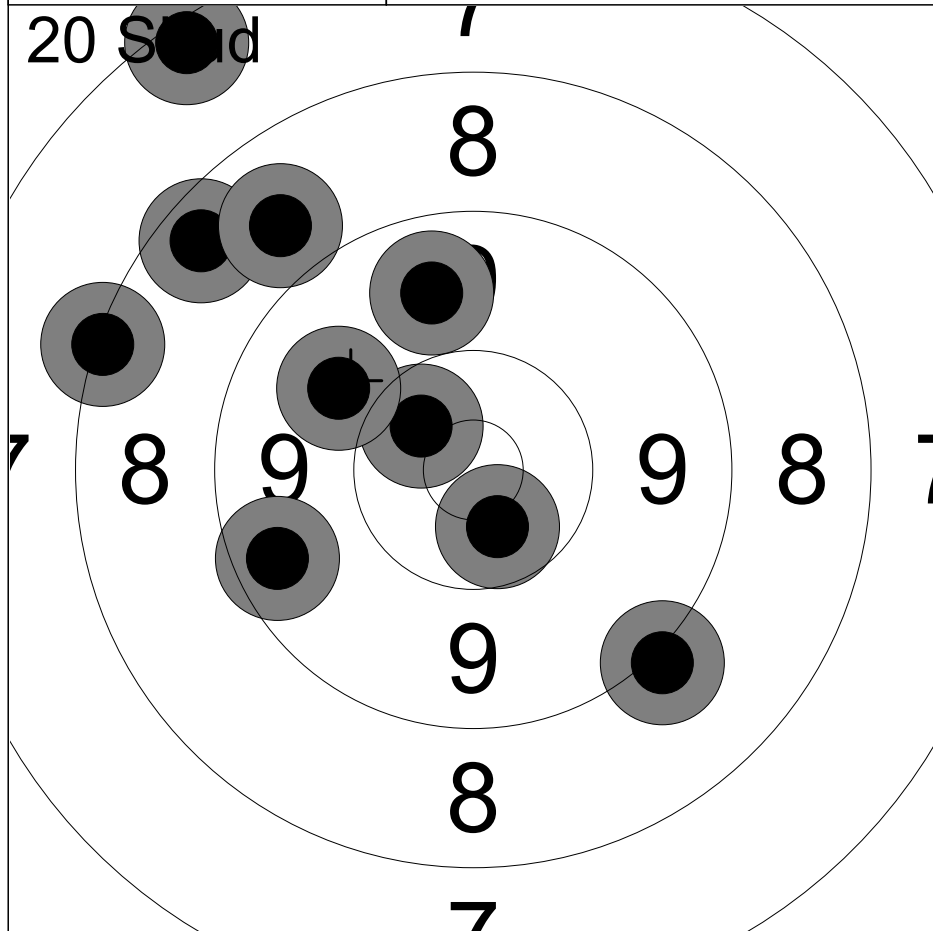

1:	8.2	↖
2:	8.5	↗
3:	7.3	↗
4:	9.1	↘
5:	10.5x	↗
6:	10.5x	↘
7:	9.7	↗
8:	8.8	↗
9:	9.9	↗
10:	9.5	↙
Serie		87 (2x)
Total		87 (2x)

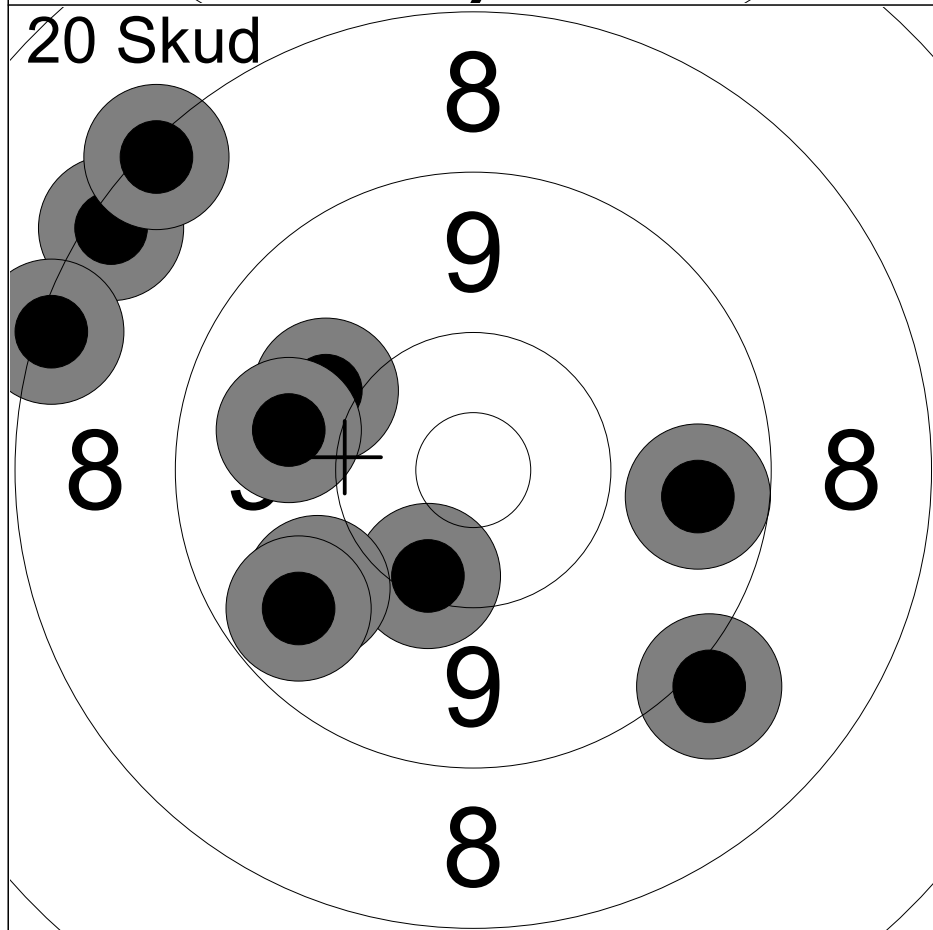

11:	9.6	→
12:	8.3	↗
13:	10.0	↗
14:	9.9	↖
15:	10.3	↘
16:	9.8	↖
17:	9.0	↘
18:	8.3	↗
19:	8.3	↗
20:	9.6	↘
Serie		89 (0x)
Total		176 (2x)

Hold 6	Skive 2	Maison Shawnley		
50M		Ramløse Idrætsforening Skydning	BK3	
10.08.2024		EM 2024	Hanebjerg Skyttecenter	
Kommentar		Signatur		

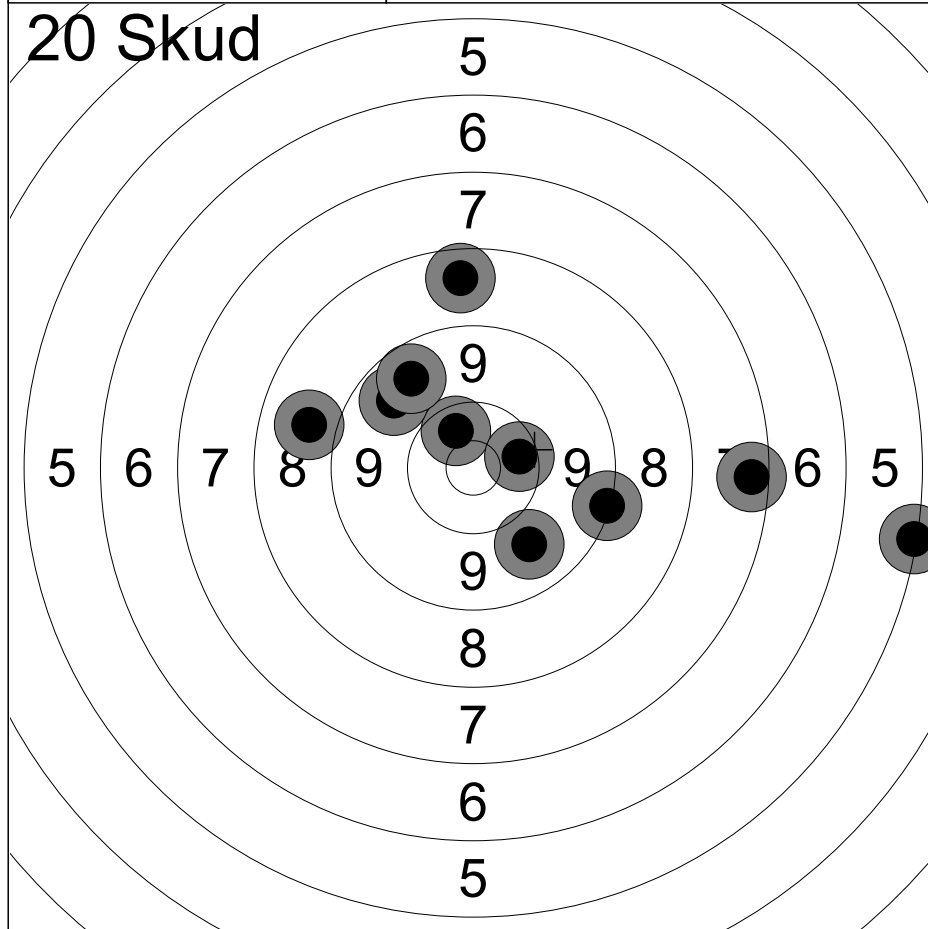

1:	10.5x	↖
2:	7.4	→
3:	9.2	↘
4:	8.8	↖
5:	10.4	→
6:	8.6	↑
7:	9.7	↗
8:	9.6	↗
9:	5.2	→
10:	9.8	↘
Serie		84 (1x)
Total		84 (1x)

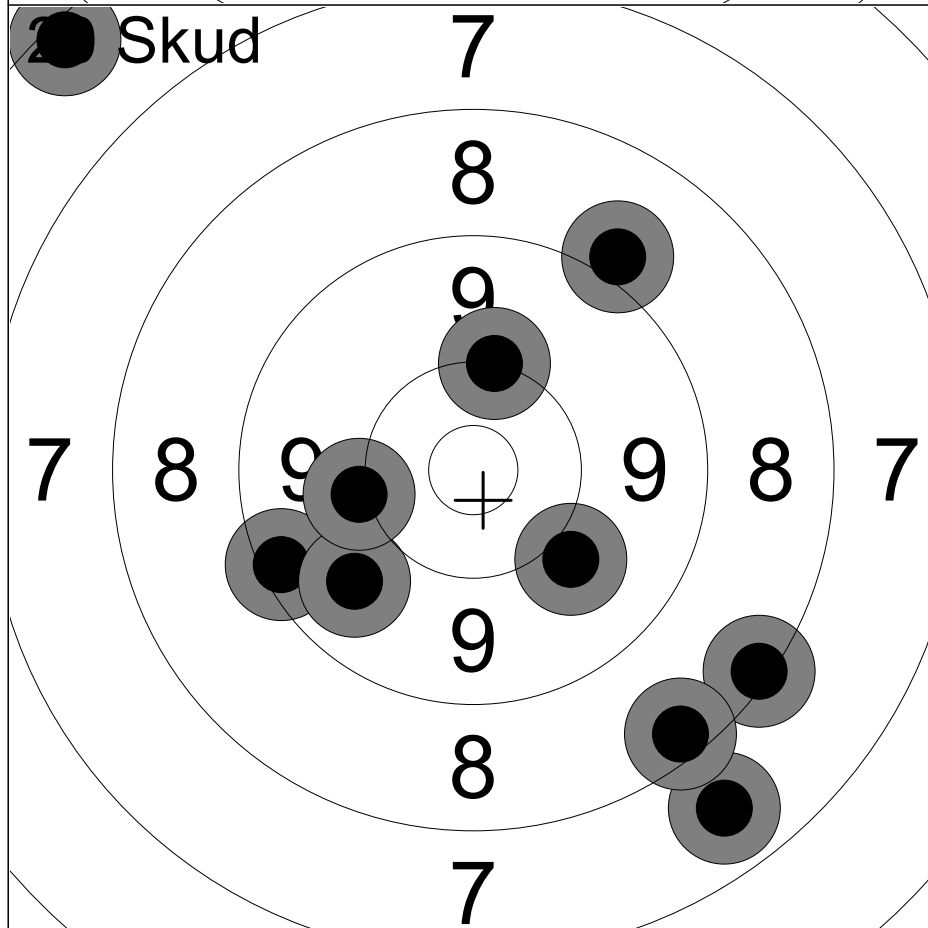

11:	9.3	↖
12:	8.3	↘
13:	7.7	↘
14:	8.4	↘
15:	9.7	↖
16:	10.1	↖
17:	10.2	↑
18:	10.0	↘
19:	6.3	↗
20:	9.0	↗
Serie		86 (0x)
Total		170 (1x)

Hold 6	Skive 3	Michelle Shawnley	
50M		Ramløse Idrætsforening Skydning	Å2
10.08.2024		EM 2024	Hanebjerg Skyttecenter
Kommentar		Signatur	

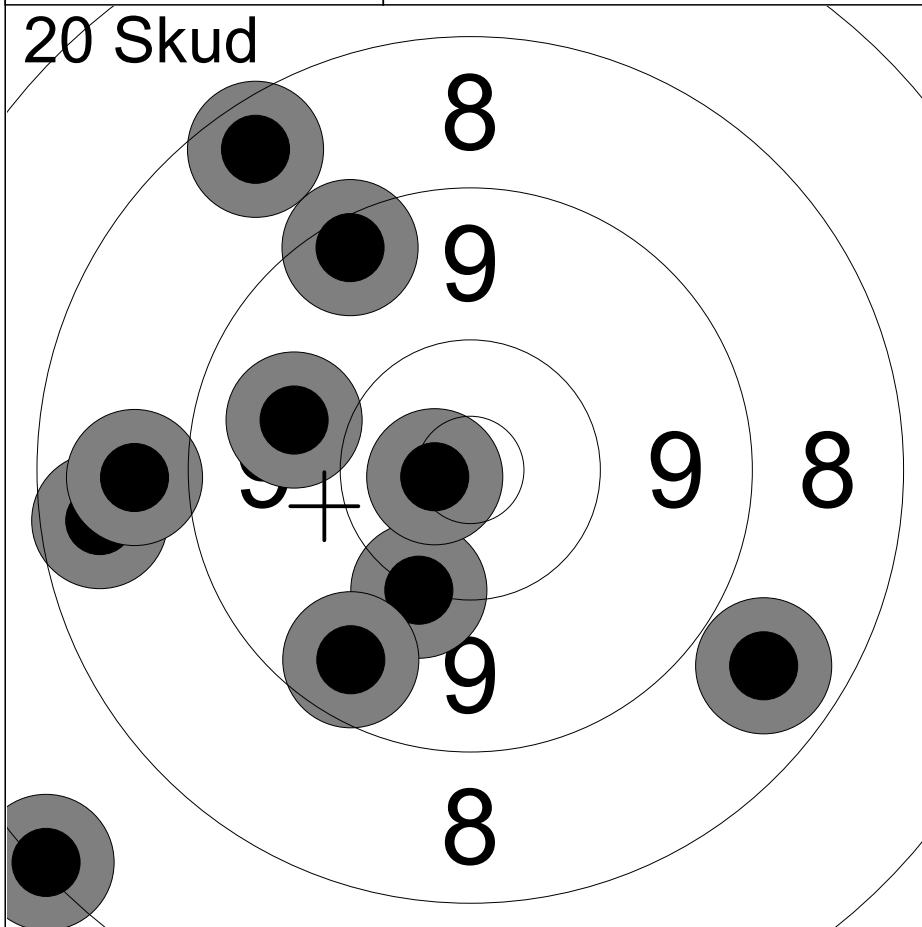

1:	8.6	←
2:	8.7	↘
3:	7.2	↙
4:	8.5	↗
5:	9.4	↗
6:	10.2	↘
7:	10.7x	←
8:	9.8	←
9:	9.6	↘
10:	8.8	←
Serie		86 (1x)
Total		86 (1x)

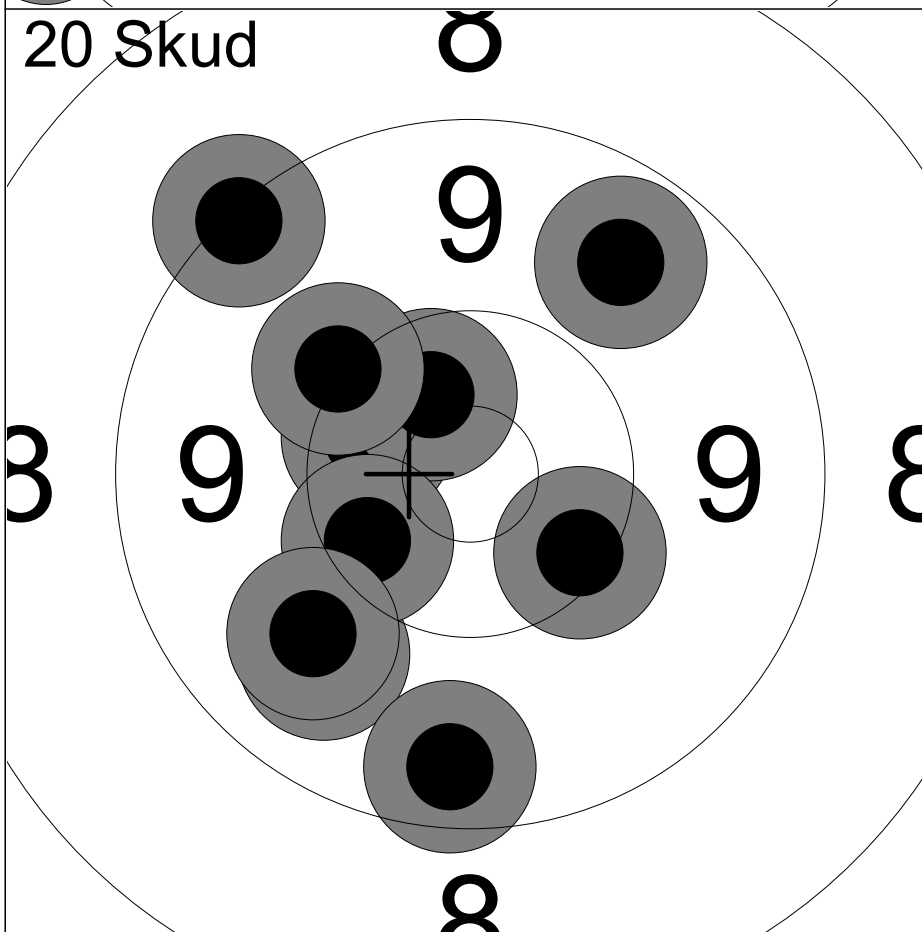

11:	9.2	↗
12:	10.3	↘
13:	9.8	↙
14:	10.4x	←
15:	10.5x	↗
16:	10.1	↗
17:	10.4	↙
18:	9.5	↘
19:	9.9	↙
20:	9.7	↗
Serie		95 (2x)
Total		181 (3x)

Hold 6	Skive 5	Bjarne Binder	
50M	Ølstykke Skytteforening	Å1	
10.08.2024	EM 2024	Hanebjerg Skyttecenter	
Kommentar	Signatur		

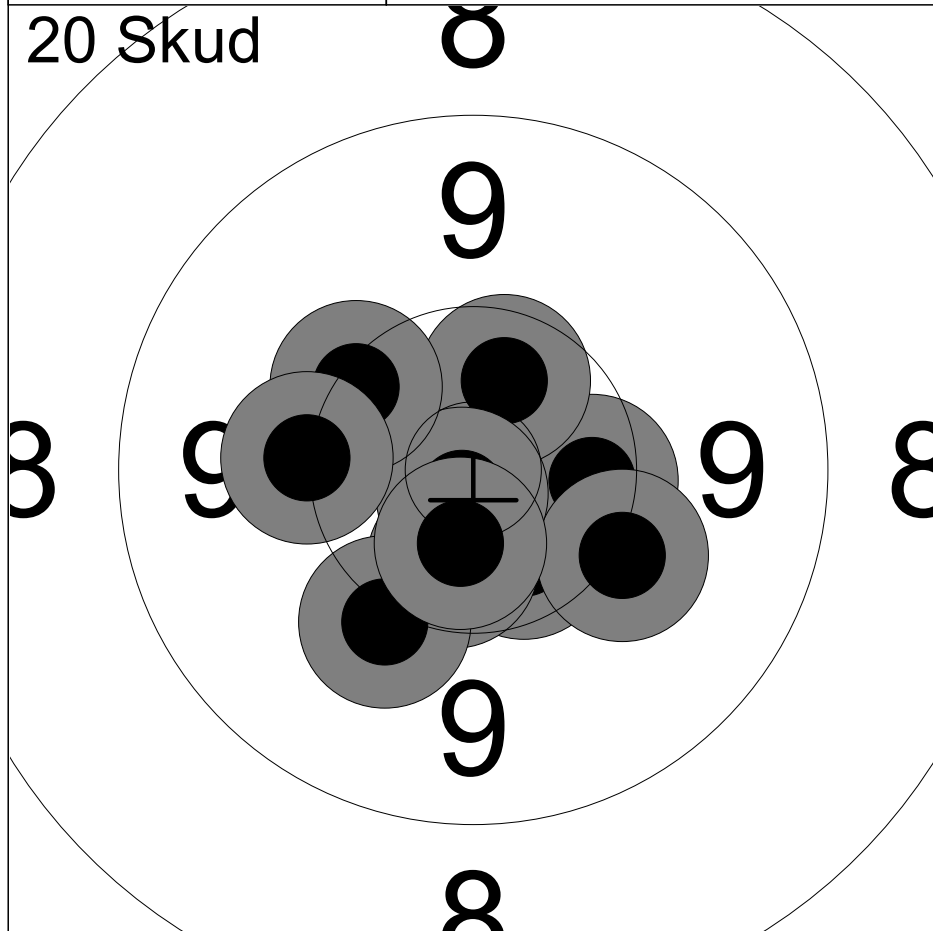

1:	10.5x	↘
2:	10.4	→
3:	10.1	↘
4:	10.5x	↘
5:	10.5x	↗
6:	10.8x	↘
7:	10.3	↖
8:	10.1	↘
9:	10.1	←
10:	10.6x	↘
Serie		100 (5x)
Total		100 (5x)

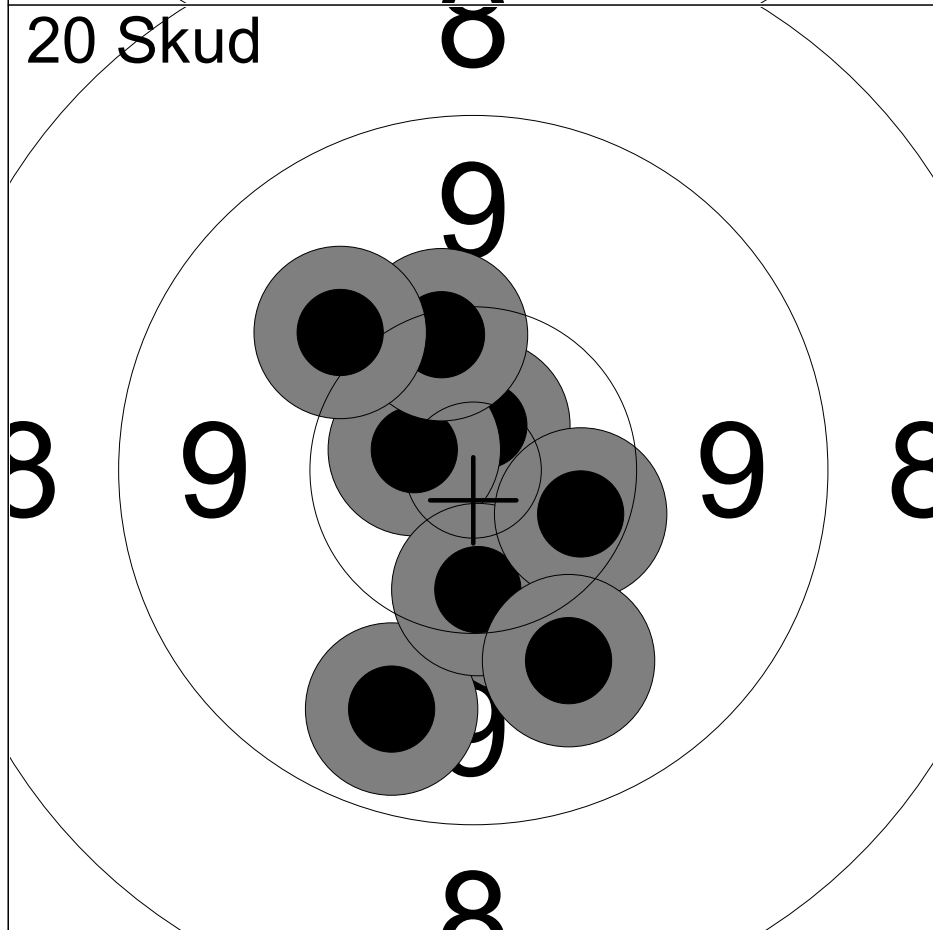

11:	10.9x	↑
12:	10.2	↘
13:	10.7x	↗
14:	9.7	↘
15:	10.6x	↖
16:	10.4	↘
17:	10.3	↗
18:	10.4	↘
19:	9.9	↘
20:	10.0	↖
Serie		98 (3x)
Total		198 (8x)

Hold 6	Skive 12	Rasmus Andersen	
50M	Frederikssund Skytteforening, I	MST3	
10.08.2024	EM 2024	Hanebjerg Skyttecenter	
Kommentar	Signatur		

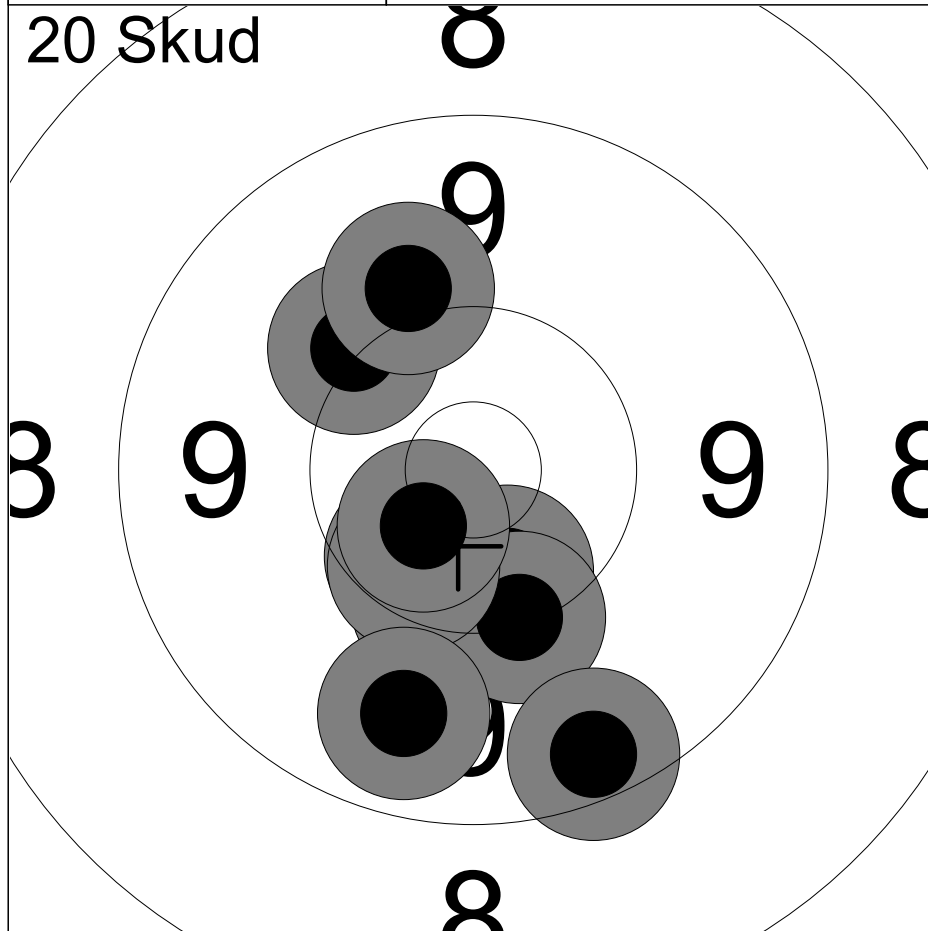

1:	10.4x	↙
2:	10.4x	↓
3:	10.3	↘
4:	10.1	↗
5:	10.2	↘
6:	10.4	↙
7:	9.7	↘
8:	9.4	↘
9:	10.6x	↙
10:	10.0	↗
Serie		98 (3x)
Total		98 (3x)

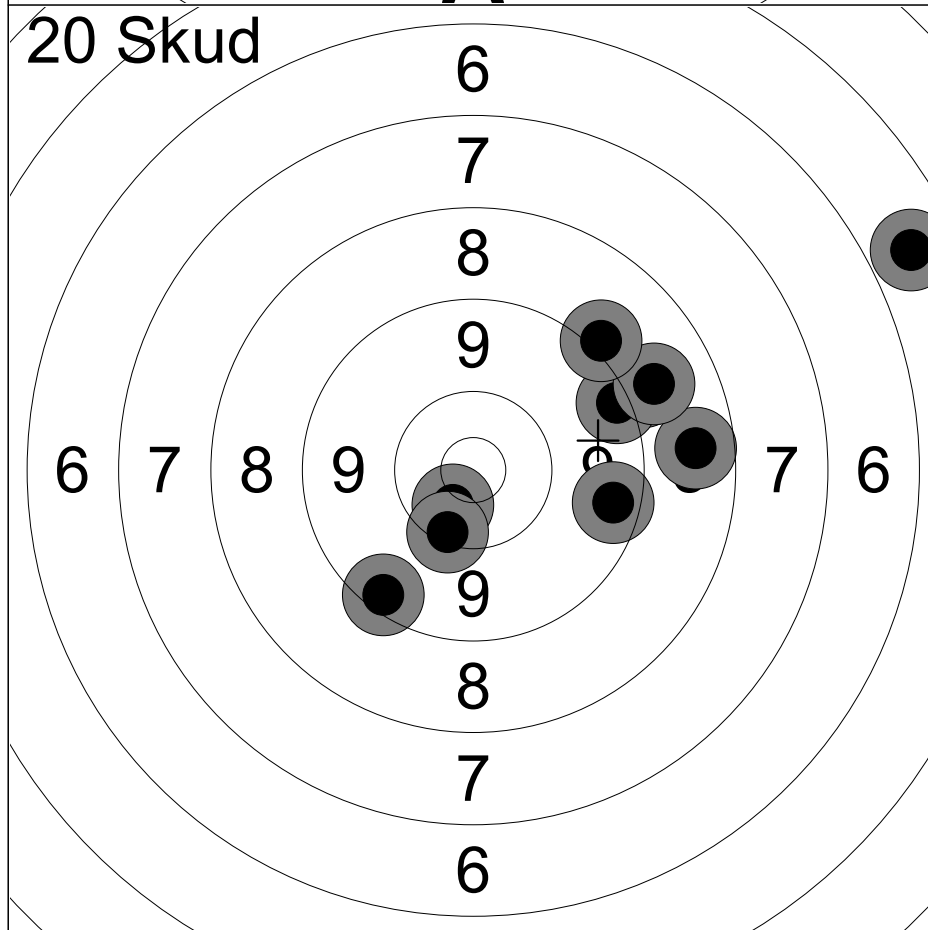

11:	10.5x	↙
12:	9.0	↗
13:	8.6	→
14:	9.4	↙
15:	9.3	↗
16:	9.5	→
17:	8.9	↗
18:	5.7	↗
19:	10.3	↘
20:	9.1	↗
Serie		86 (1x)
Total		184 (4x)

Hold 8	Skive 1	Clara M. Dahl		
50M		Ramløse Idrætsforening Skydning	MBK3	
10.08.2024		EM 2024	Hanebjerg Skyttecenter	
Kommentar		Signatur		

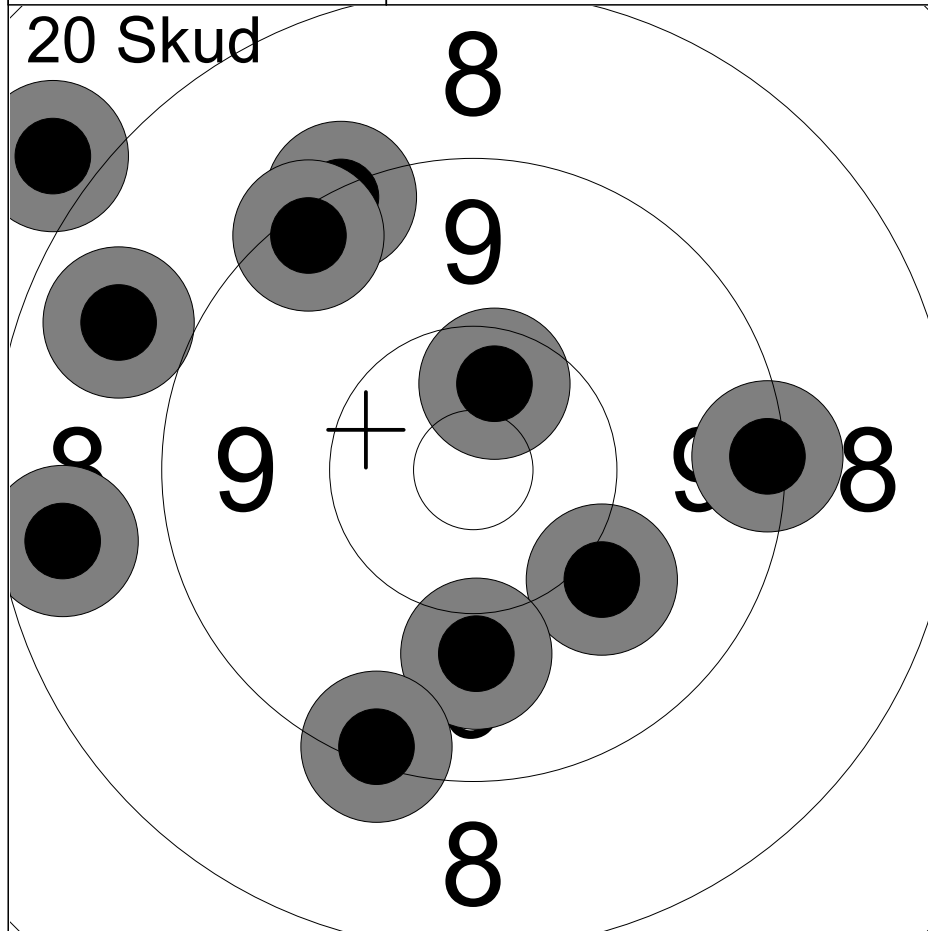

1:	8.7	↖
2:	8.5	↖
3:	10.0	↘
4:	10.5x	↗
5:	9.9	↘
6:	9.2	↗
7:	9.3	↘
8:	9.3	→
9:	9.3	↗
10:	7.9	↖
Serie		88 (1x)
Total		88 (1x)

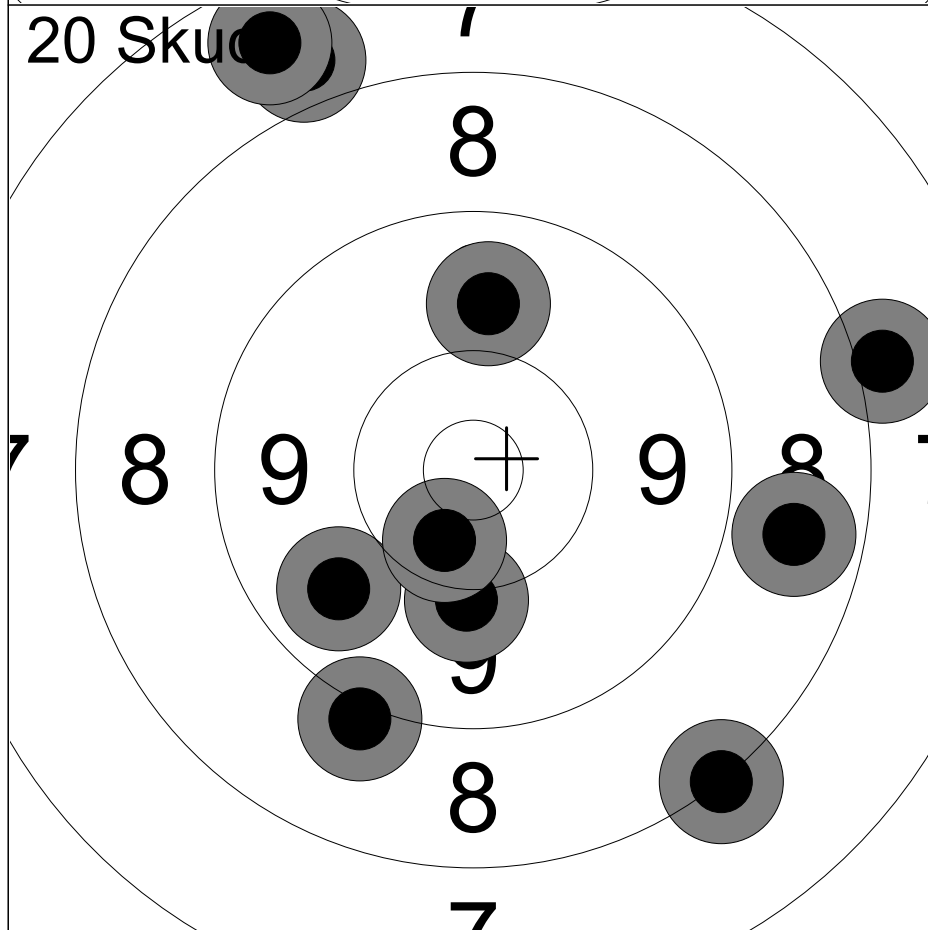

11:	9.1	↘
12:	9.7	↖
13:	7.8	↗
14:	9.8	↗
15:	7.6	↗
16:	8.2	↘
17:	8.7	→
18:	8.0	→
19:	10.1	↘
20:	10.4x	↘
Serie		85 (1x)
Total		173 (2x)

Hold 8	Skive 2	Maison Shawnley		
50M	Ramløse Idrætsforening Skydning	MBK3		
10.08.2024	EM 2024	Hanebjerg Skyttecenter		
Kommentar	Signatur			

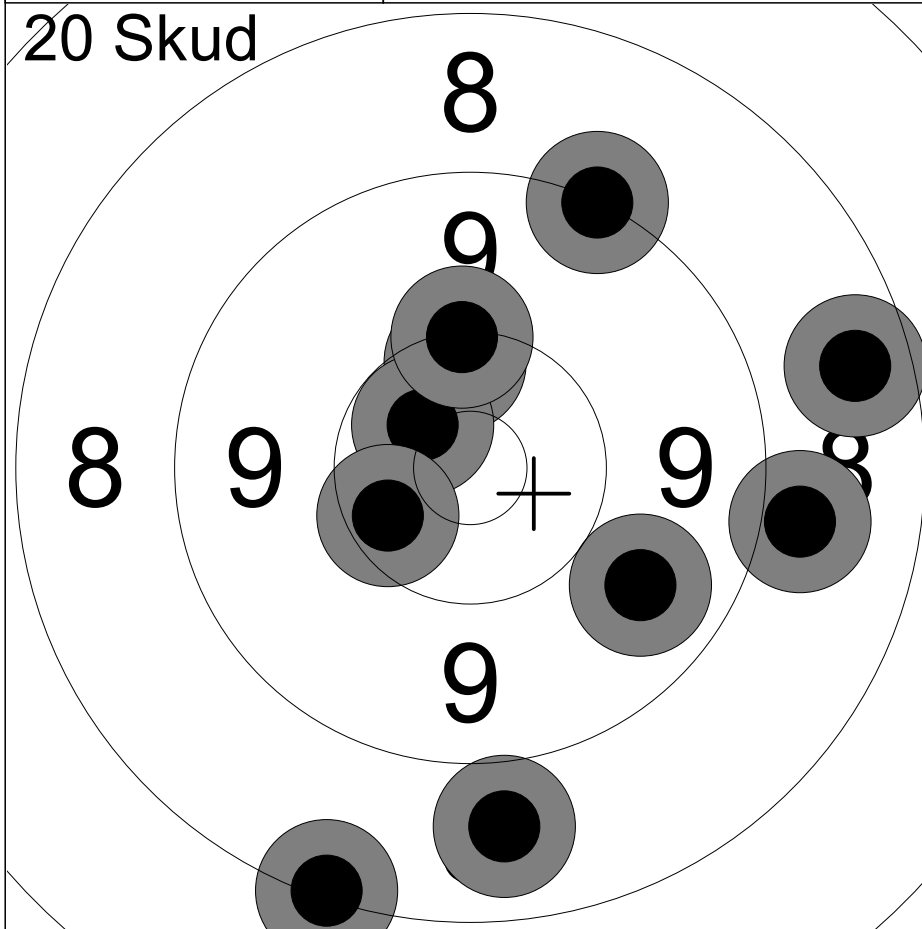

1:	9.2	↗
2:	10.3	↑
3:	8.2	↘
4:	8.9	→
5:	8.8	↘
6:	10.6x	↗
7:	9.7	↘
8:	10.2	↑
9:	8.5	→
10:	10.4	↙
Serie		90 (1x)
Total		90 (1x)

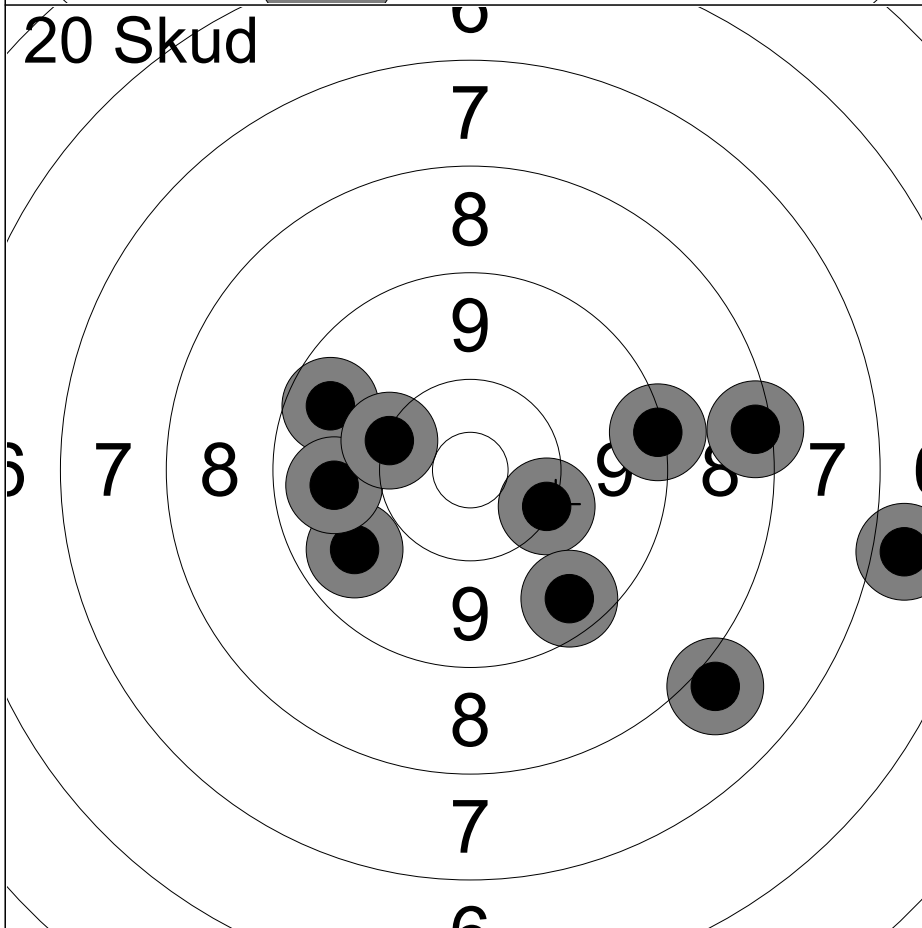

11:	9.7	↖
12:	8.0	↘
13:	9.2	→
14:	9.6	↗
15:	9.7	←
16:	6.9	→
17:	10.2	↘
18:	8.3	→
19:	9.5	↘
20:	10.2	↖
Serie		87 (0x)
Total		177 (1x)

Hold 8	Skive 3	Michelle Shawnley		
50M		Ramløse Idrætsforening Skydning	MÅ2	
10.08.2024		EM 2024	Hanebjerg Skyttecenter	
Kommentar		Signatur		

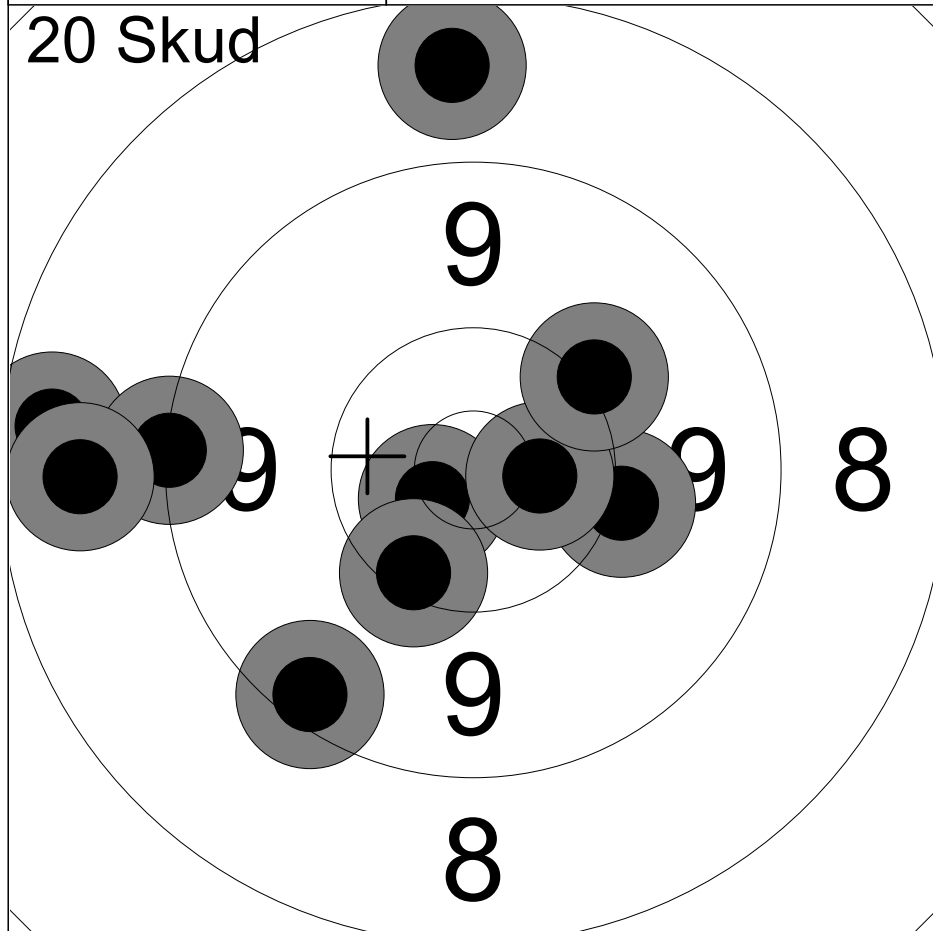

1:	10.7x	↙
2:	8.5	←
3:	10.1	→
4:	10.3	↘
5:	9.4	↙
6:	9.2	←
7:	10.6x	→
8:	10.1	↗
9:	8.6	↑
10:	8.7	←
Serie		92 (2x)
Total		92 (2x)

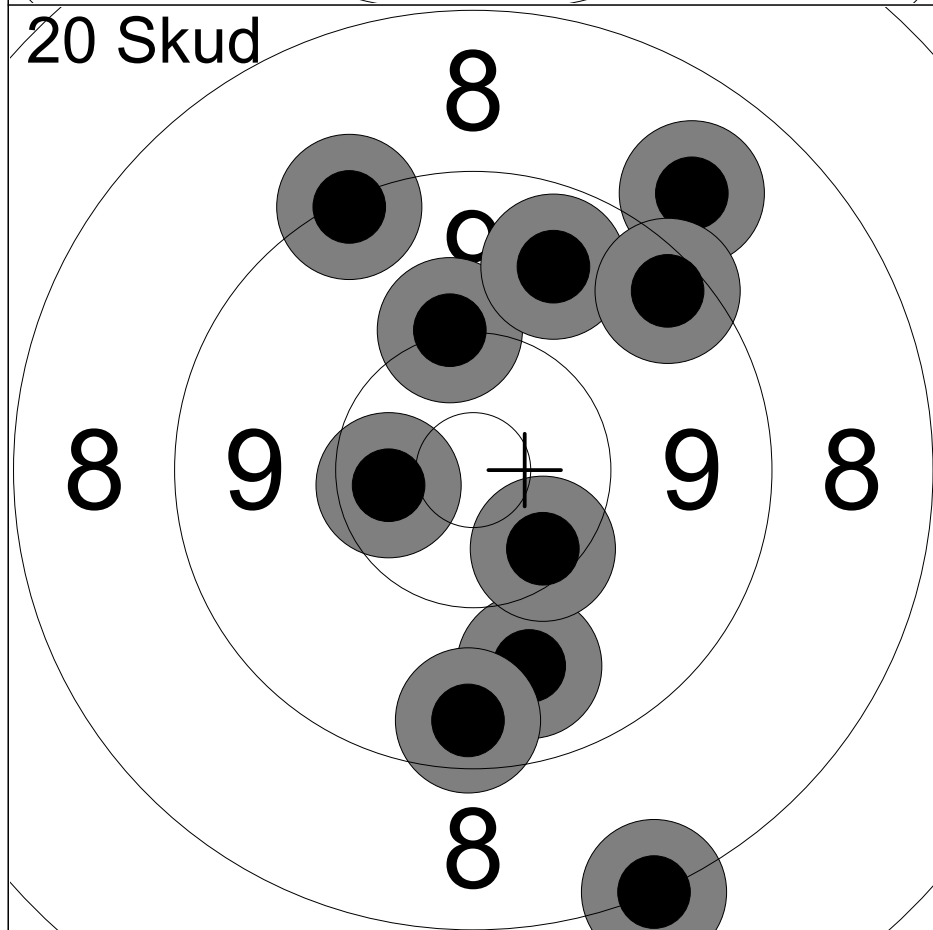

11:	10.5x	←
12:	10.1	↑
13:	9.8	↘
14:	9.7	↗
15:	9.2	↗
16:	8.8	↗
17:	10.3	↘
18:	9.5	↘
19:	9.4	↗
20:	8.2	↘
Serie		91 (1x)
Total		183 (3x)

Hold 8	Skive 5	Bjarne Binder	
50M	Ølstykke Skytteforening	MÅ1	
10.08.2024	EM 2024	Hanebjerg Skyttecenter	
Kommentar	Signatur		

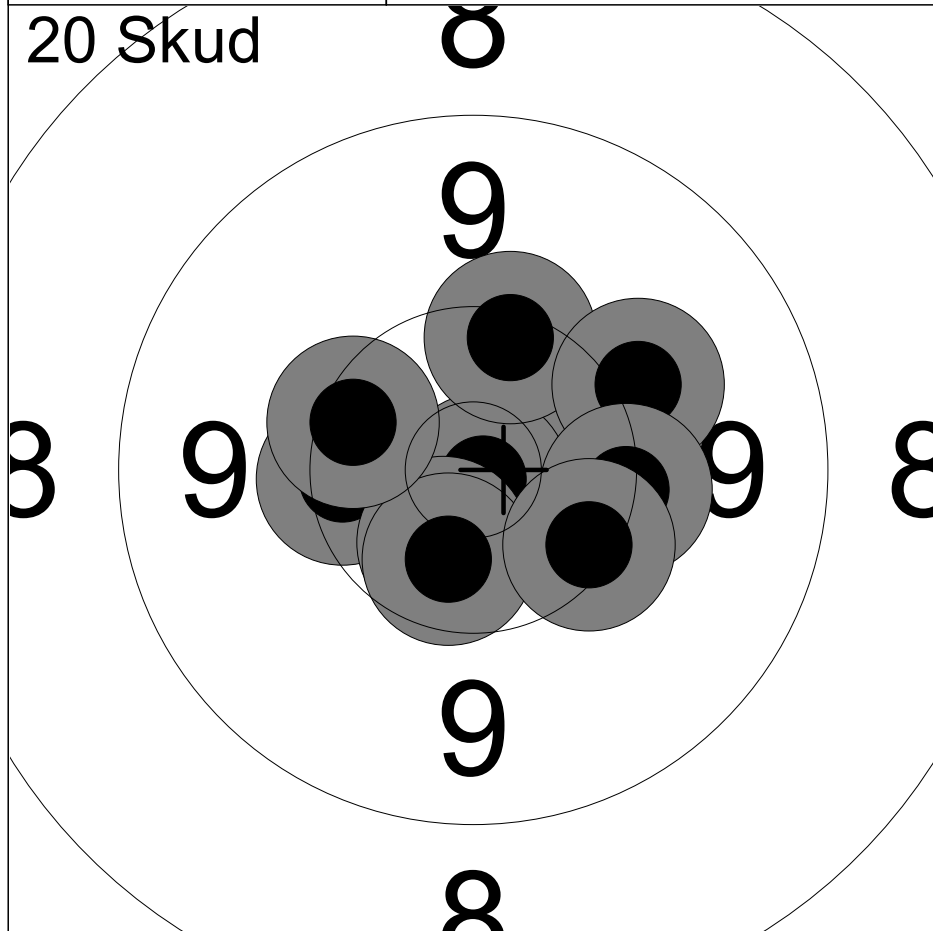

1:	10.3	→
2:	10.9x	↘
3:	10.3	↑
4:	10.3	←
5:	10.0	↗
6:	10.6x	↙
7:	10.5x	↘
8:	10.2	→
9:	10.3	↘
10:	10.3	↙
Serie	100 (3x)	
Total	100 (3x)	

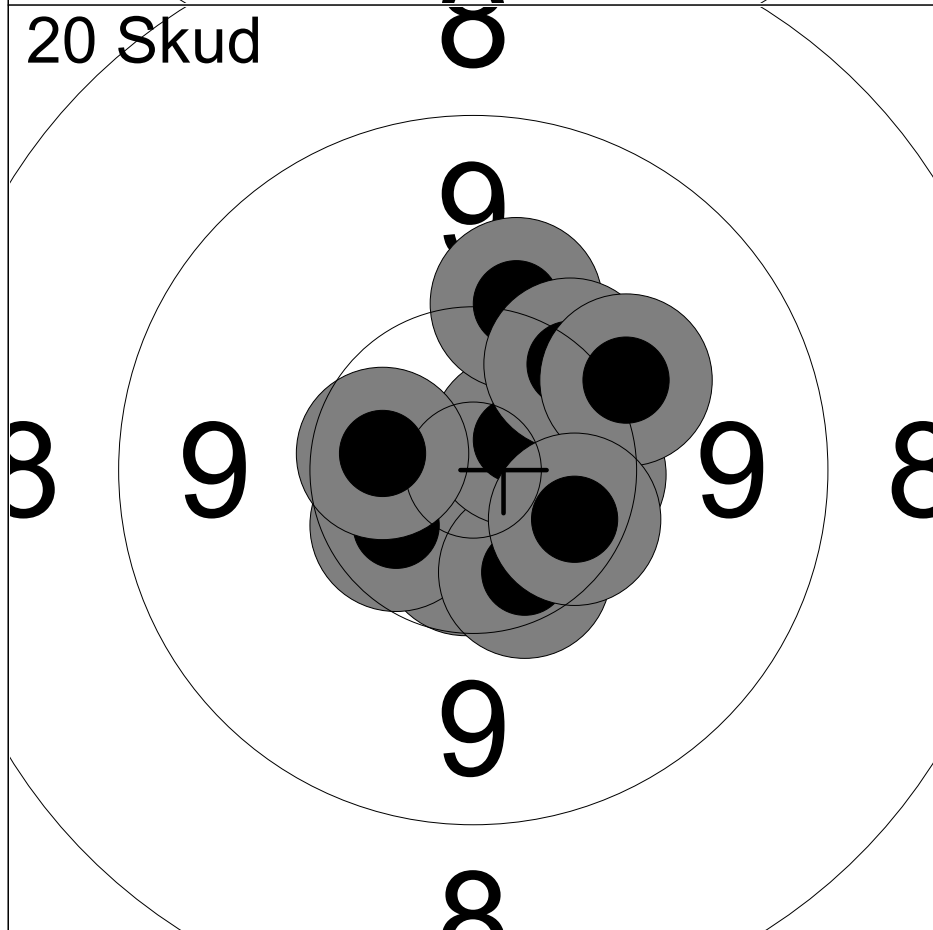

11:	10.4x	→
12:	10.6x	↘
13:	10.5x	↙
14:	10.4	↘
15:	10.7x	↗
16:	10.1	↑
17:	10.3	↗
18:	10.1	↗
19:	10.5x	←
20:	10.4	↘
Serie	100 (5x)	
Total	200 (8x)	

Hold 17	Skive 1	Carsten Heegaard Petersen	
50M		Ganløse Skytteforening	Å2
10.08.2024		EM 2024	Hanebjerg Skyttecenter
Kommentar		Signatur	

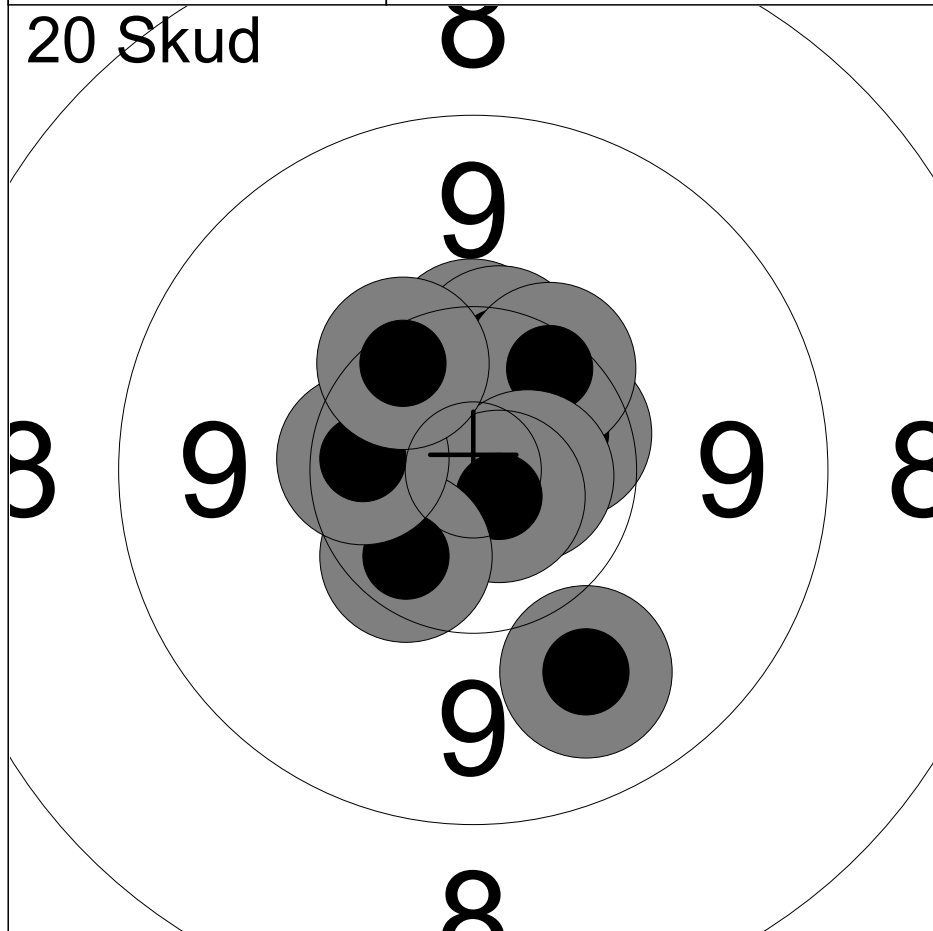

1:	10.3	↑
2:	10.5x	→
3:	10.4	↑
4:	10.3	↗
5:	9.8	↘
6:	10.7x	→
7:	10.8x	↘
8:	10.4x	↘
9:	10.4	←
10:	10.3	↖
Serie		99 (4x)
Total		99 (4x)

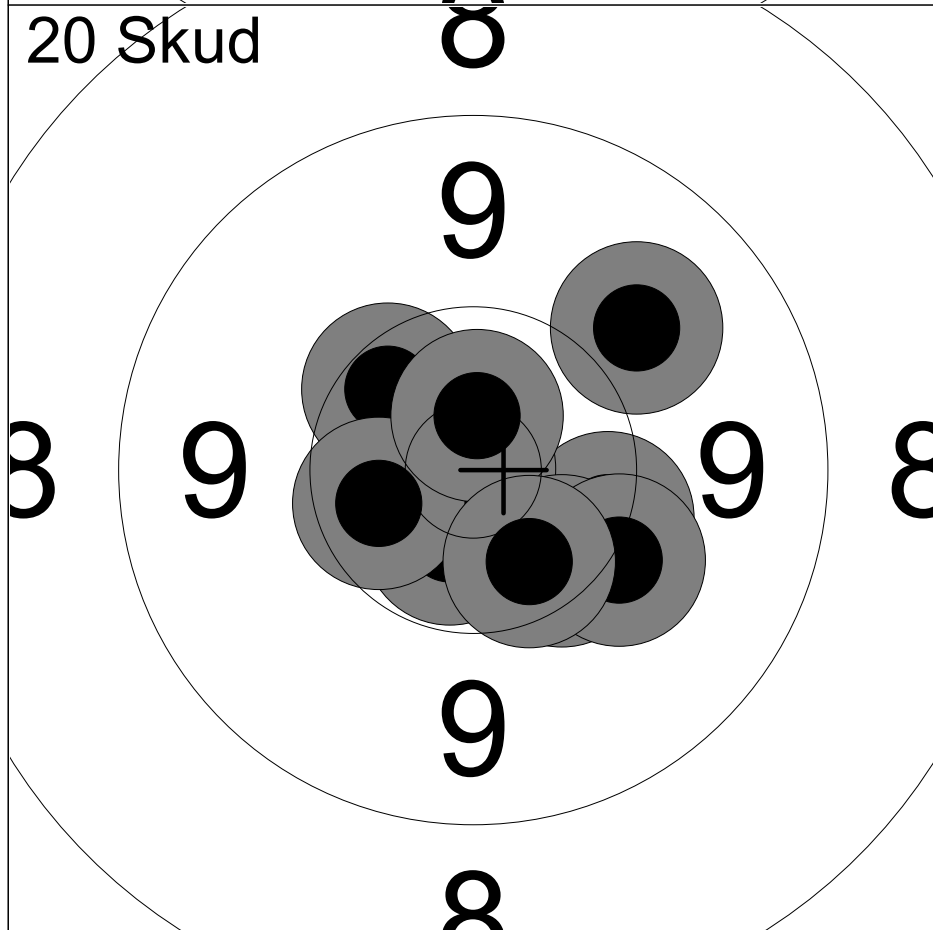

11:	10.3	→
12:	10.9x	↖
13:	10.6x	↘
14:	10.3	↘
15:	10.4	↗
16:	10.1	↘
17:	10.5x	←
18:	10.7x	↑
19:	10.4x	↘
20:	9.9	↗
Serie		99 (5x)
Total		198 (9x)

Hold 17	Skive 3	Lea Linda Bejning Andersen	
50M	Ølstykke Skytteforening	Å2	
10.08.2024	EM 2024	Hanebjerg Skyttecenter	
Kommentar	Signatur		

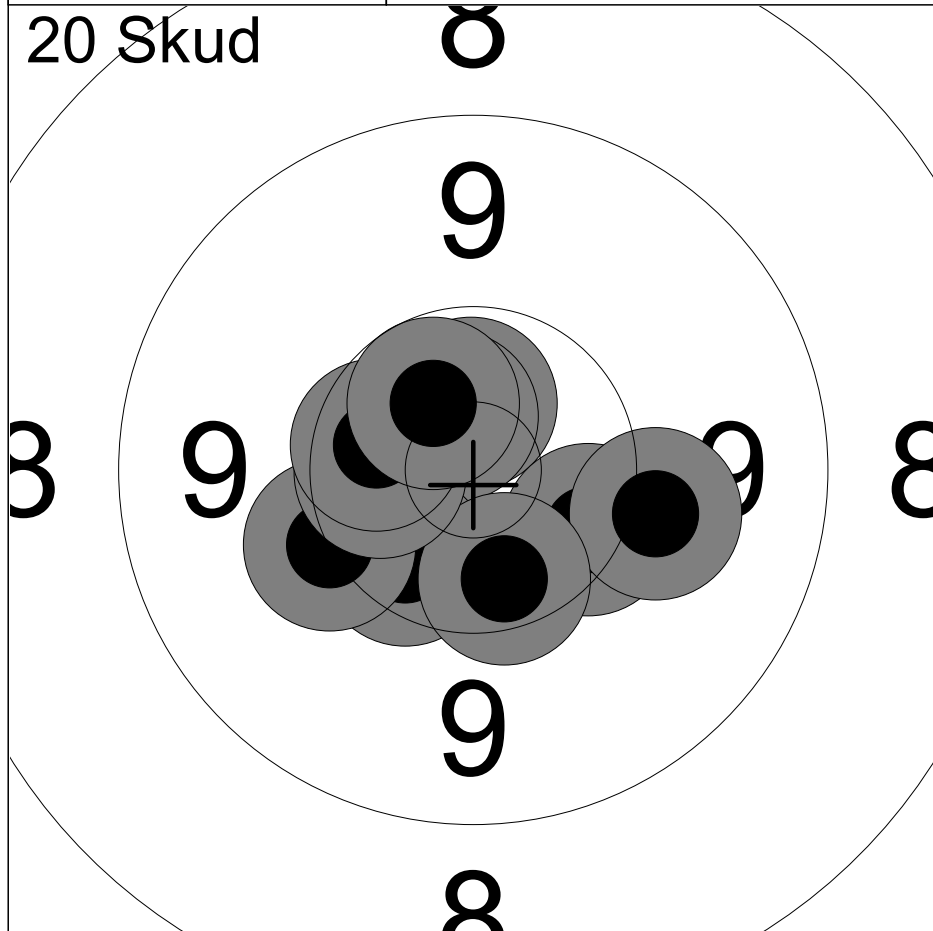

1:	10.6x	↑
2:	10.7x	↗
3:	10.3	↘
4:	10.0	→
5:	10.4	↙
6:	10.2	←
7:	10.4	↘
8:	10.5x	←
9:	10.5x	←
10:	10.6x	↗
Serie	100 (5x)	
Total	100 (5x)	

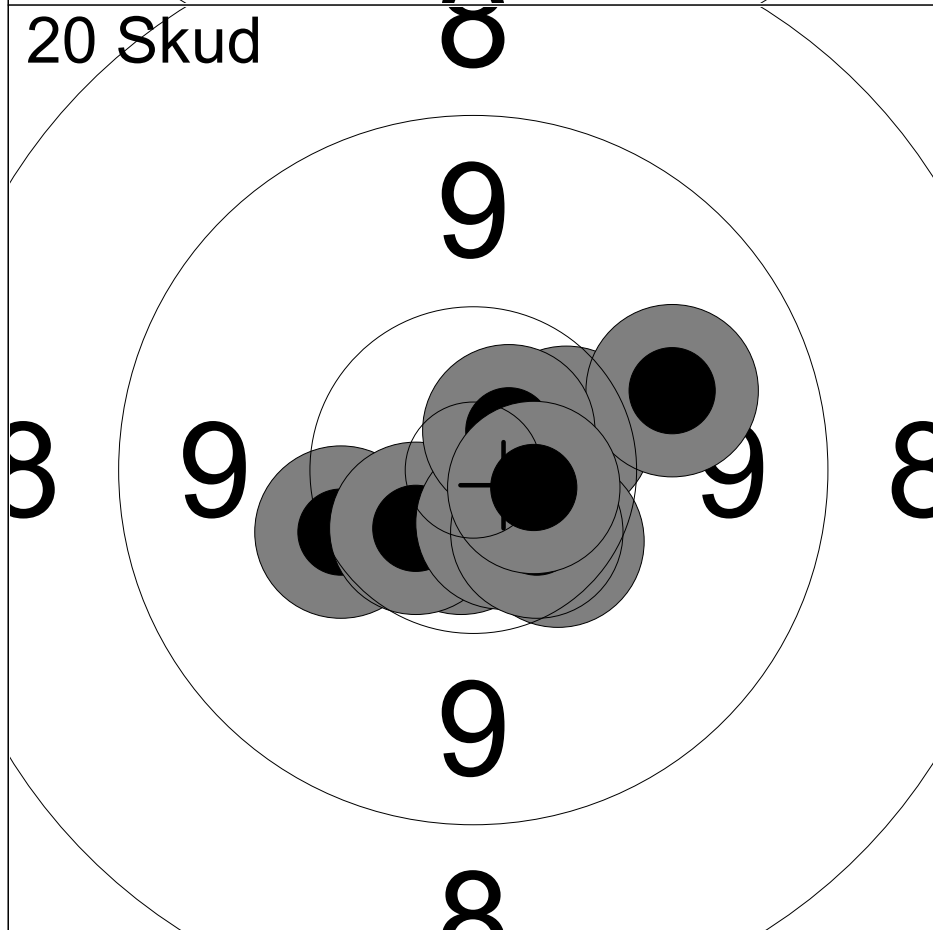

11:	10.5x	↗
12:	9.9	↗
13:	10.2	↙
14:	10.7x	↘
15:	10.6x	↙
16:	10.7x	↘
17:	10.4x	↘
18:	10.5x	↘
19:	10.7x	↗
20:	10.6x	→
Serie	99 (8x)	
Total	199 (13x)	

Hold 17	Skive 5	Kurt Witt		
50M		Ølstykke Skytteforening		ST3
10.08.2024		EM 2024		Hanebjerg Skyttecenter
Kommentar		Signatur		

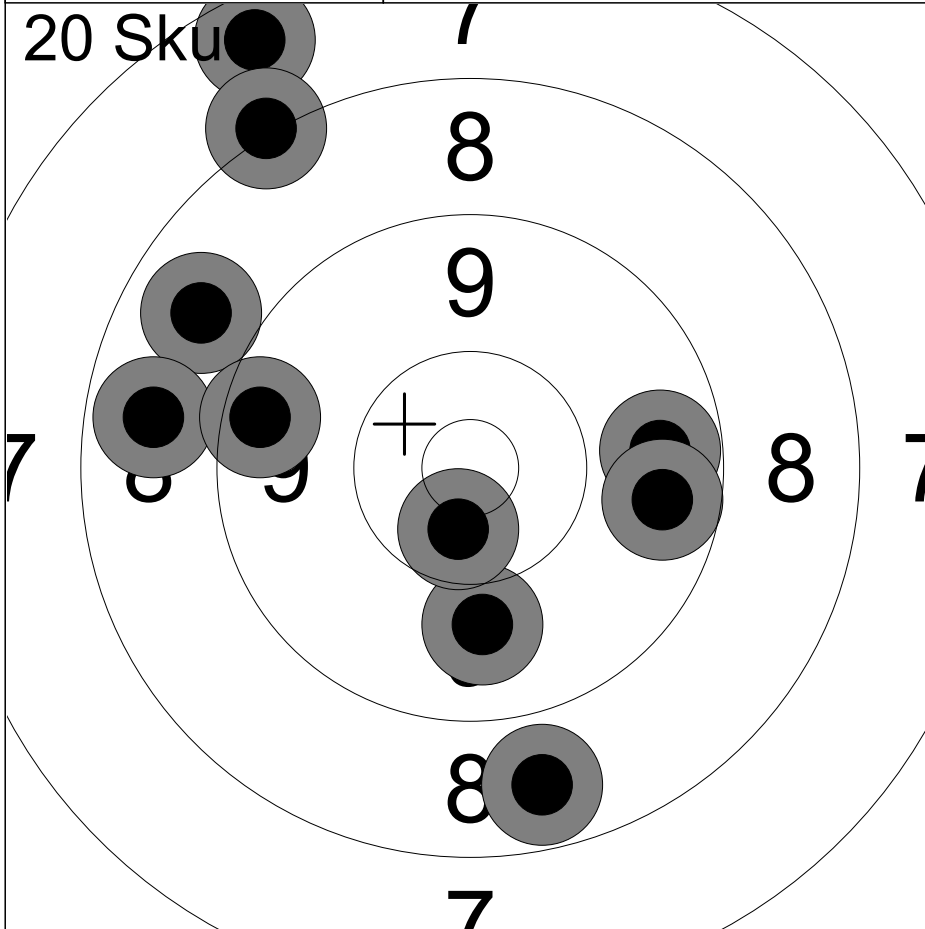

1:	8.6	↓
2:	8.8	↗
3:	9.6	→
4:	8.7	↖
5:	9.6	↗
6:	7.5	↗
7:	8.1	↗
8:	9.9	↓
9:	9.4	↖
10:	10.5x	↓
Serie		85 (1x)
Total		85 (1x)

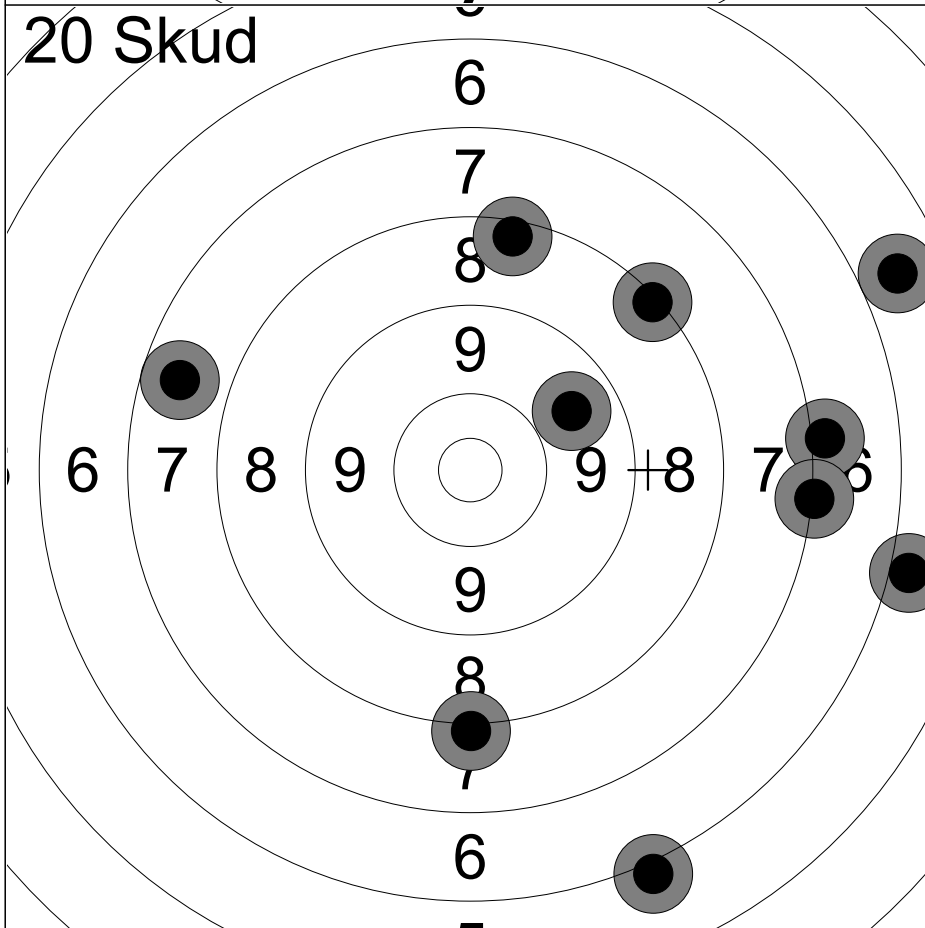

11:	8.4	↑
12:	7.0	→
13:	9.7	↗
14:	8.1	↓
15:	8.2	↗
16:	6.0	↓
17:	7.6	↖
18:	5.7	↗
19:	7.1	→
20:	6.0	→
Serie		71 (0x)
Total		156 (1x)

Hold 18	Skive 1	Bjoern Thomsen	
50M	Ganløse Skytteforening	Å1	
10.08.2024	EM 2024	Hanebjerg Skyttecenter	
Kommentar	Signatur		

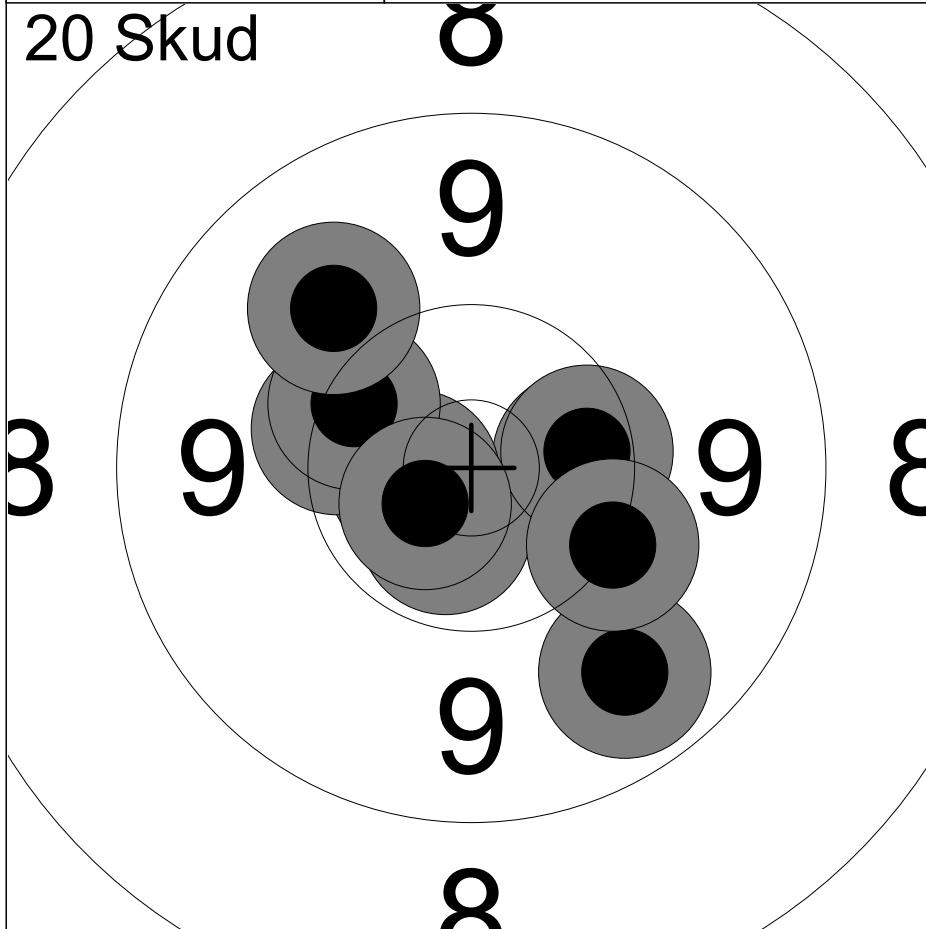

1:	10.4x	→
2:	10.6x	↘
3:	10.7x	←
4:	10.3	↗
5:	10.3	↗
6:	9.9	↗
7:	9.7	↘
8:	10.4	→
9:	10.7x	↙
10:	10.2	↘
Serie		98 (4x)
Total		98 (4x)

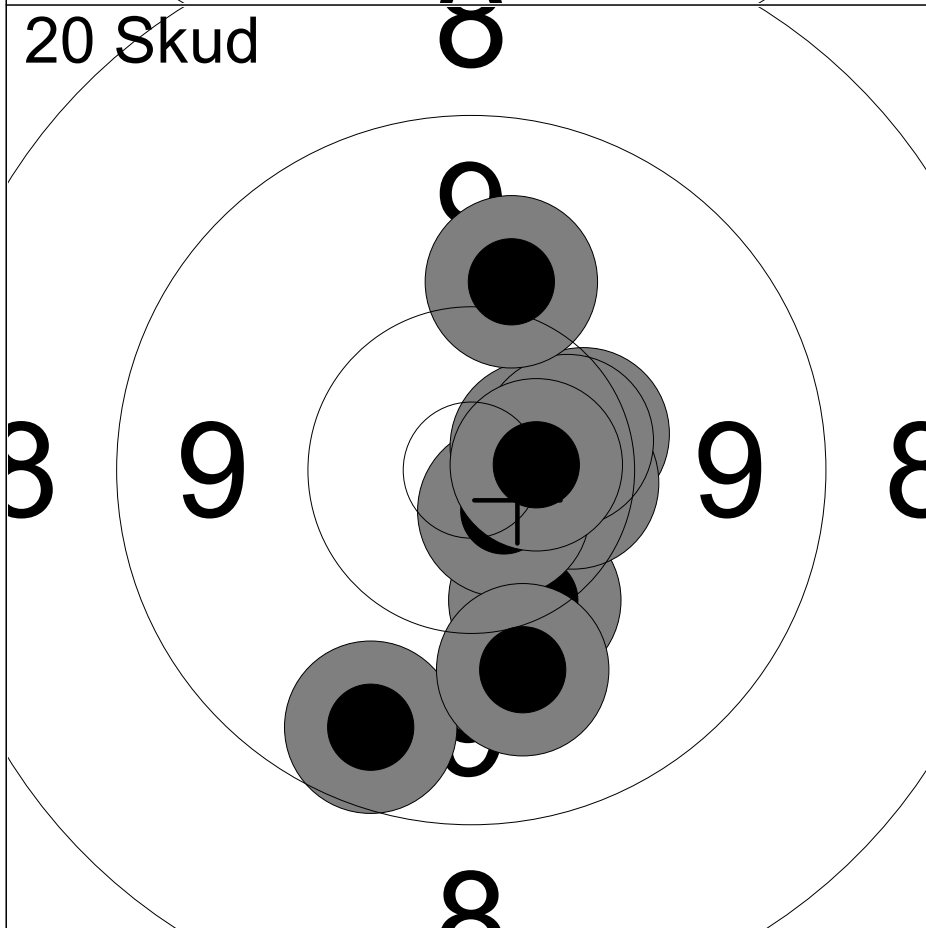

11:	9.6	↘
12:	10.2	↘
13:	10.4	↗
14:	10.5x	→
15:	10.7x	↘
16:	10.6x	↗
17:	9.9	↘
18:	10.5x	↗
19:	10.6x	→
20:	10.0	↗
Serie		98 (5x)
Total		196 (9x)

Hold 18	Skive 2	Agnete Soerensen	
50M	Frederikssund Skytteforening, I	Å1	
10.08.2024	EM 2024	Hanebjerg Skyttecenter	
Kommentar	Signatur		

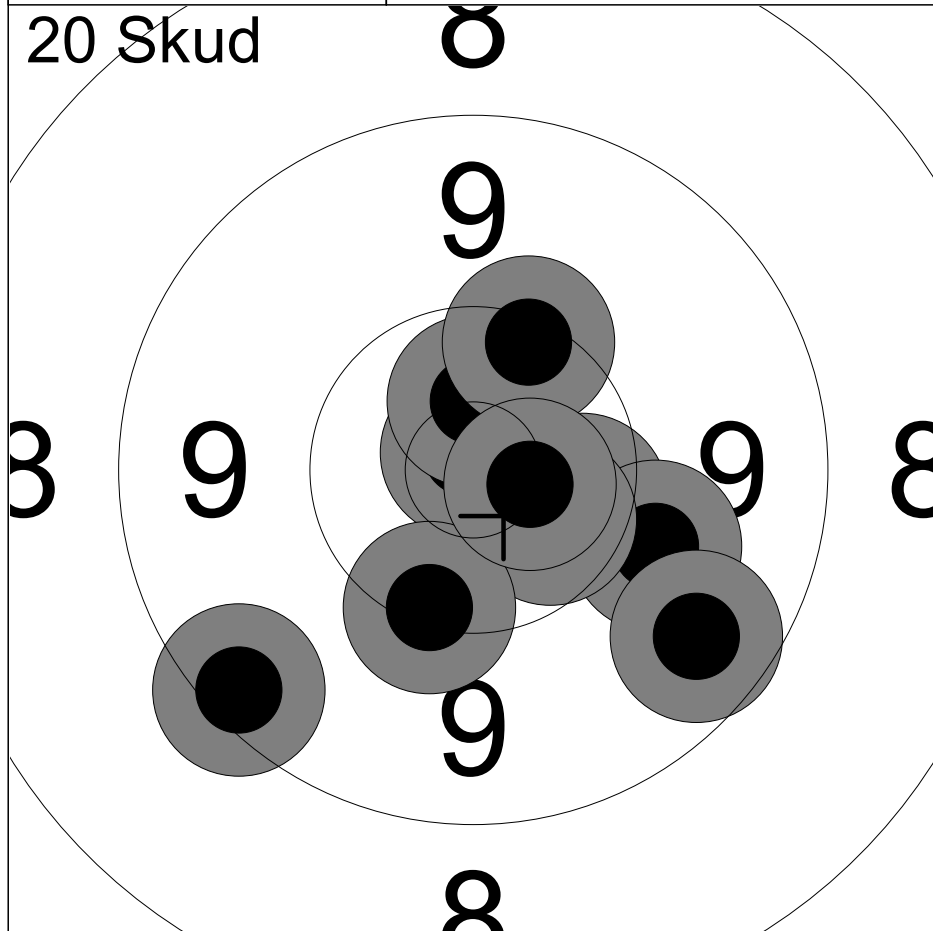

1:	10.9x	↖
2:	10.6x	↑
3:	10.4	→
4:	10.0	↘
5:	10.5x	↙
6:	10.3	↗
7:	9.6	↘
8:	10.2	↙
9:	9.3	↖
10:	10.7x	→

Serie	98 (4x)
Total	98 (4x)



11:	10.5x	↑
12:	10.2	↗
13:	10.3	↘
14:	10.9x	↙
15:	10.5x	↗
16:	10.3	↗
17:	10.2	↗
18:	10.3	↘
19:	10.6x	↗
20:	10.4	↑

Serie	100 (4x)
Total	198 (8x)

Hold 18	Skive 5	Noelle Misfeldt Kvist-Andersen	
50M	Ganløse Skytteforening	BK2	
10.08.2024	EM 2024	Hanebjerg Skyttecenter	
Kommentar	Signatur		

20 Skud

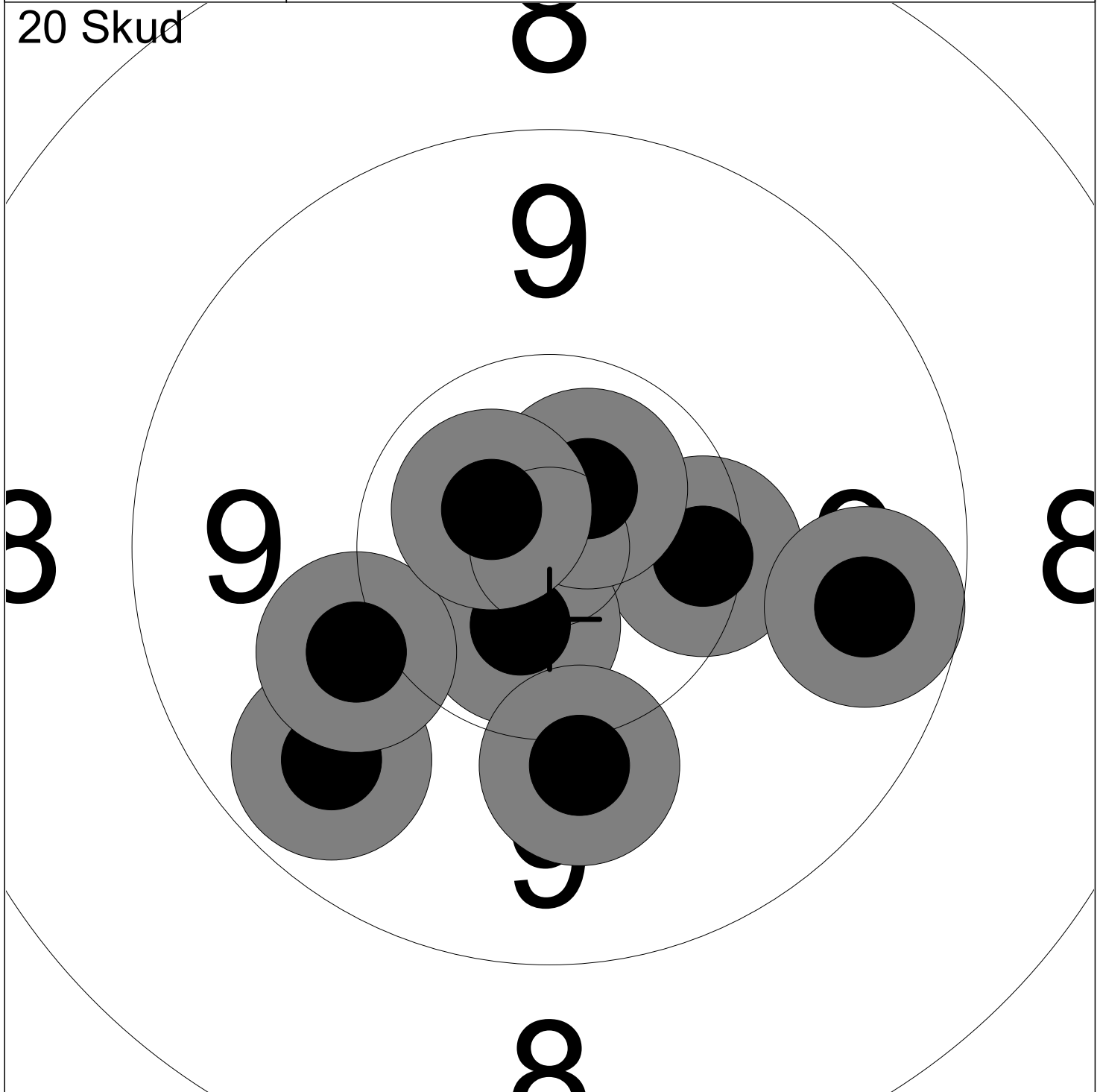

1: 10.3	→	6: 10.7x	↖	Serie	78 (3x)
2: 10.6x	↙	7: 10.0	↘		
3: 10.7x	↗	8: 9.6	↘	Total	78 (3x)
4: 9.7	↙				
5: 10.0	↙				

Hold 18	Skive 6	Kurt Witt	
50M	Ølstykke Skytteforening	MST3	
10.08.2024	EM 2024	Hanebjerg Skyttecenter	
Kommentar	Signatur		

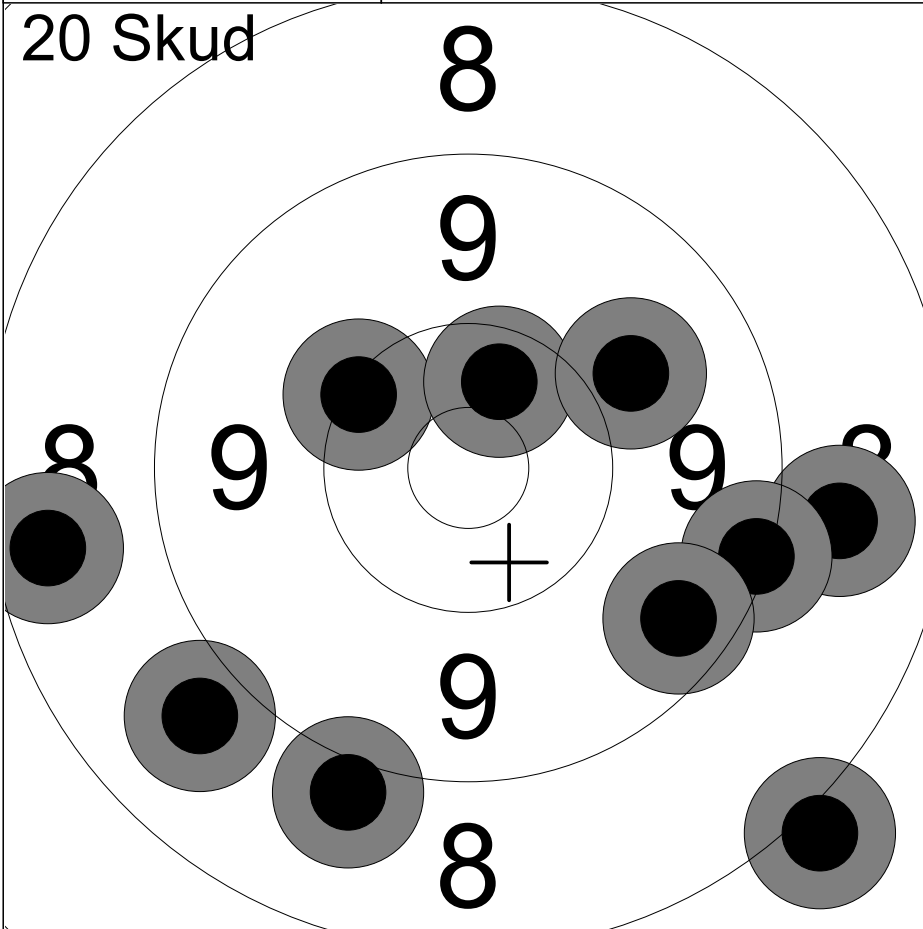

1:	8.8	→
2:	8.5	←
3:	8.0	↘
4:	10.2	↗
5:	9.2	→
6:	9.0	↘
7:	10.4x	↗
8:	9.5	↘
9:	8.9	←
10:	9.9	↗
Serie		88 (1x)
Total		88 (1x)

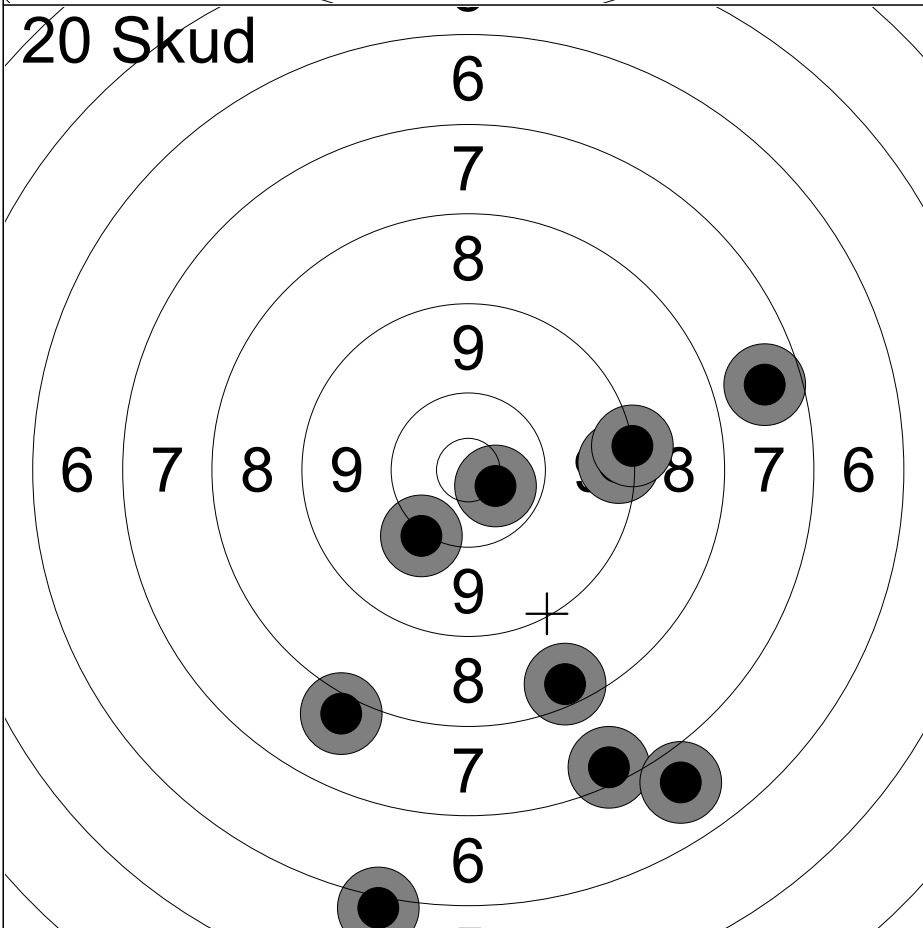

11:	7.4	↘
12:	10.1	↘
13:	7.6	→
14:	10.6x	↘
15:	9.3	→
16:	8.0	↘
17:	6.8	↘
18:	6.0	↘
19:	8.4	↘
20:	9.2	→
Serie		80 (1x)
Total		168 (2x)

Hold 18	Skive 7	Anton Ellegaard Soerensen	
50M	Kreds 57, Ferslev, Skibby	Å1	
10.08.2024	EM 2024	Hanebjerg Skyttecenter	
Kommentar	Signatur		

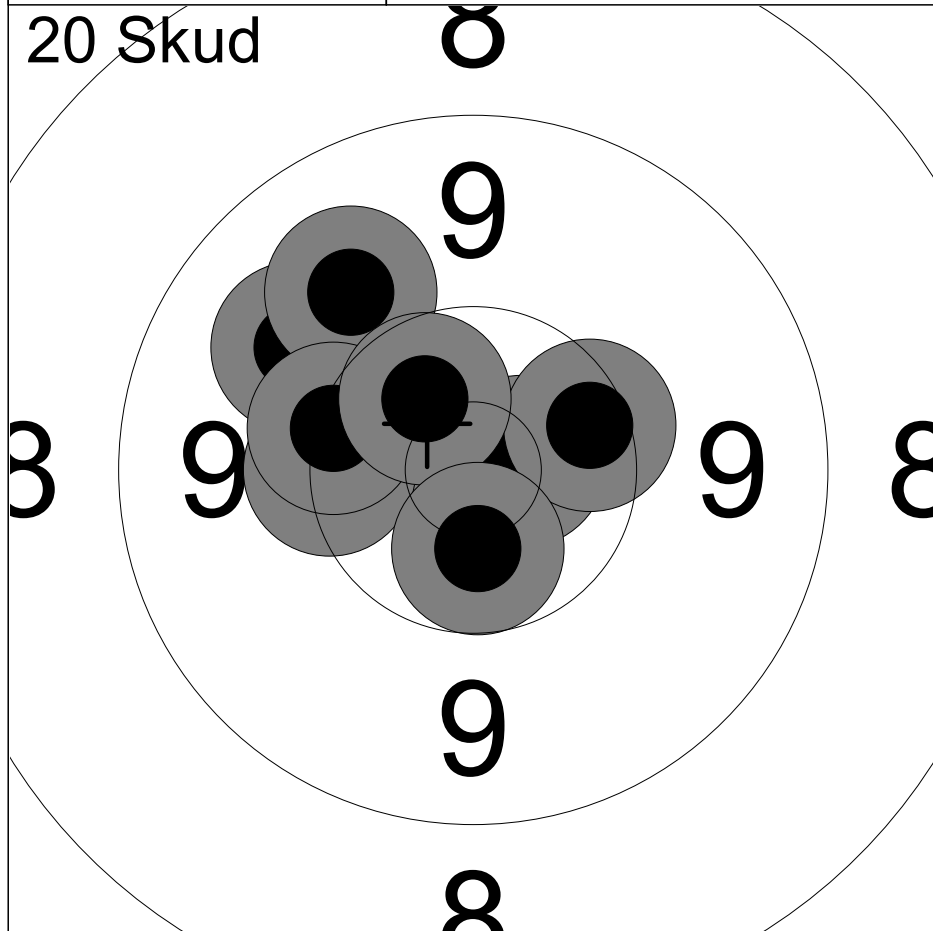

1:	10.6x	↖
2:	10.6x	↖
3:	9.9	↖
4:	10.7x	→
5:	10.3	←
6:	9.9	↖
7:	10.2	↖
8:	10.3	↗
9:	10.5x	↖
10:	10.6x	↓
Serie		98 (5x)
Total		98 (5x)

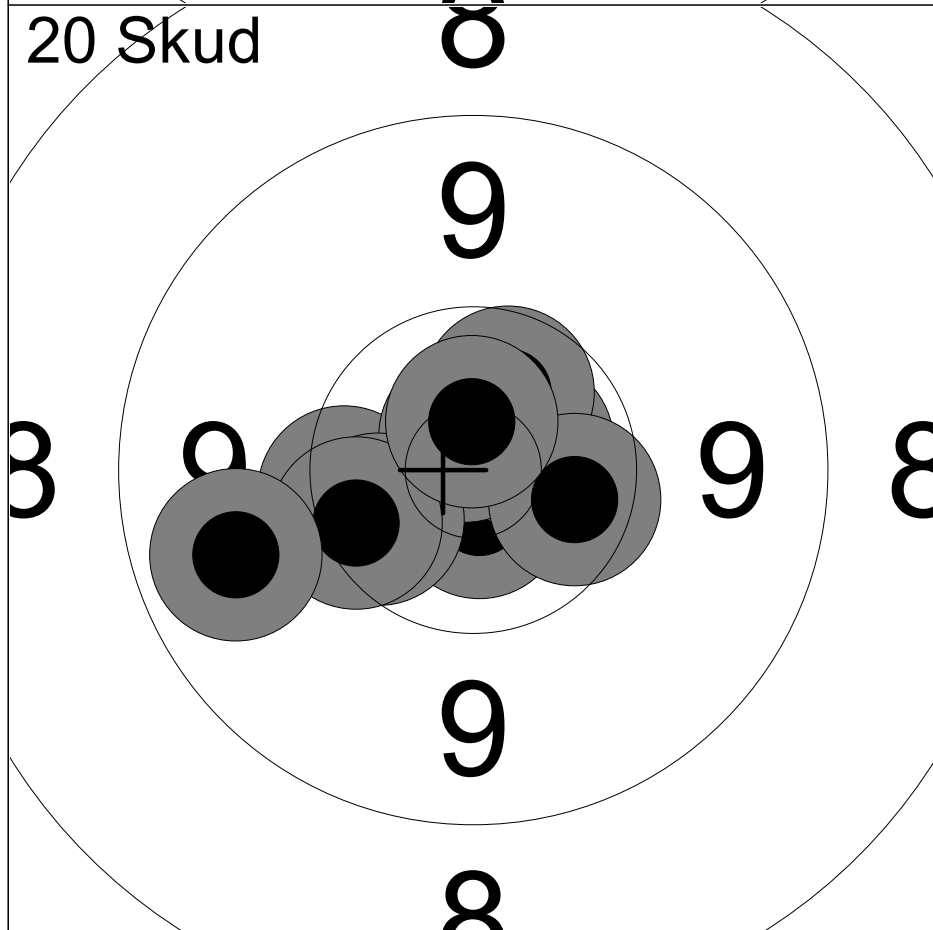

11:	10.3	←
12:	10.7x	↓
13:	10.7x	↗
14:	10.8x	↖
15:	10.4x	↖
16:	10.3	←
17:	10.5x	↖
18:	10.4x	→
19:	9.7	←
20:	10.7x	↖
Serie		99 (7x)
Total		197 (12x)

Hold 19	Skive 1	René Andersen	
50M		Ølstykke Skytteforening	Å1
10.08.2024		EM 2024	Hanebjerg Skyttecenter
Kommentar		Signatur	



1:	10.4x	←
2:	10.8x	↑
3:	10.6x	←
4:	10.7x	↘
5:	10.6x	↗
6:	10.4	→
7:	10.9x	←
8:	10.7x	↙
9:	10.5x	↙
10:	10.6x	←
Serie		100 (9x)
Total		100 (9x)



11:	10.7x	↑
12:	10.9x	↖
13:	10.5x	↑
14:	10.5x	↗
15:	10.6x	←
16:	10.7x	→
17:	10.8x	←
18:	10.7x	←
19:	10.6x	↙
20:	10.7x	←
Serie		100 (10x)
Total		200 (19x)

Hold 19	Skive 2	Carsten Heegaard Petersen	
50M	Ganløse Skytteforening	MÅ2	
10.08.2024	EM 2024	Hanebjerg Skyttecenter	
Kommentar	Signatur		



1:	10.2	↗
2:	10.4x	↘
3:	10.8x	↗
4:	10.7x	↗
5:	10.8x	↗
6:	10.5x	↗
7:	10.2	↘
8:	10.6x	↘
9:	10.4	↗
10:	10.8x	↗
Serie		100 (7x)
Total		100 (7x)

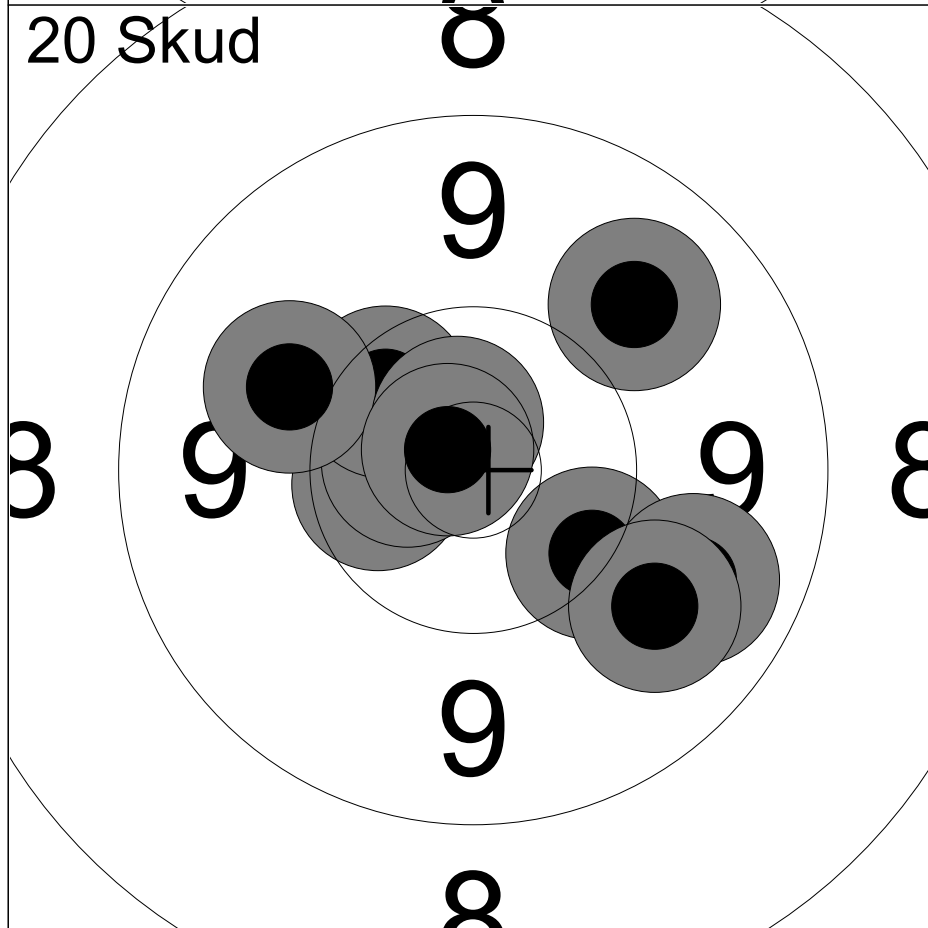

11:	10.5x	←
12:	10.6x	←
13:	10.4	↗
14:	10.2	↘
15:	9.7	↘
16:	10.0	↗
17:	9.8	↗
18:	9.8	↘
19:	10.7x	↗
20:	10.8x	↗
Serie		97 (4x)
Total		197 (11x)

Hold 19	Skive 4	Lea Linda Bejning Andersen	
50M	Ølstykke Skytteforening	MÅ2	
10.08.2024	EM 2024	Hanebjerg Skyttecenter	
Kommentar	Signatur		

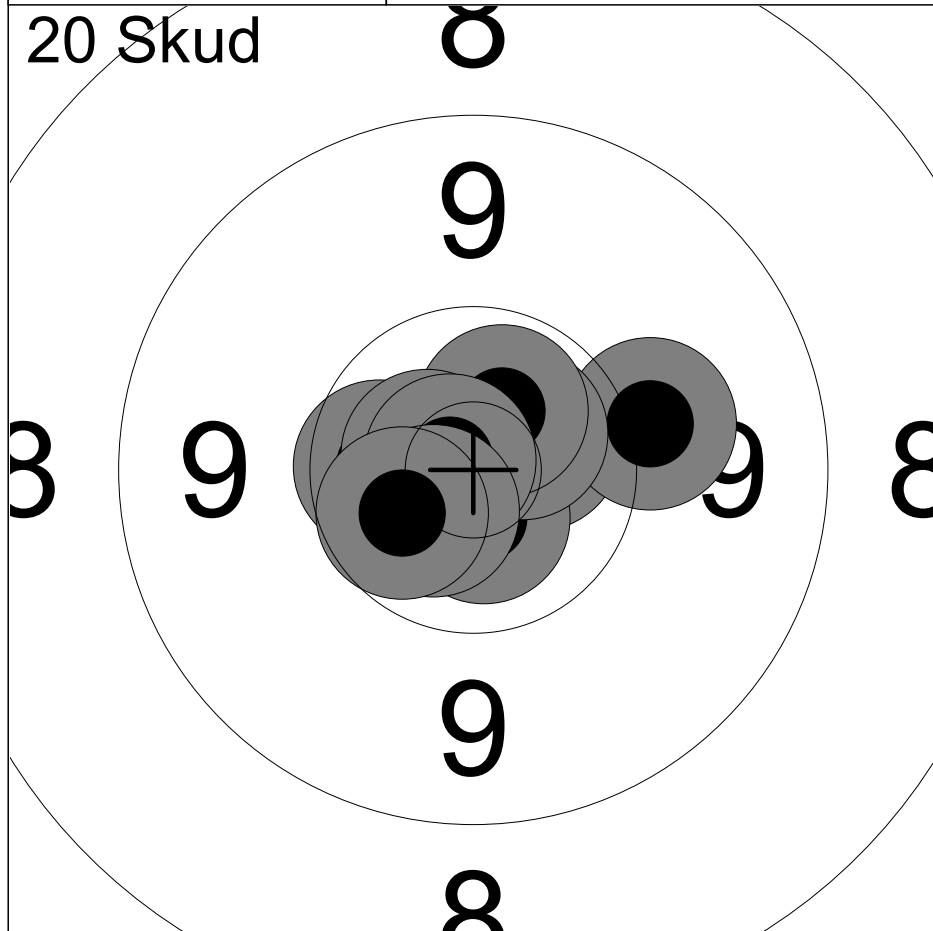

1:	10.5x	←
2:	10.6x	→
3:	10.7x	↓
4:	10.1	→
5:	10.7x	↗
6:	10.6x	↖
7:	10.7x	←
8:	10.8x	↖
9:	10.7x	↙
10:	10.5x	↙
Serie		100 (9x)
Total		100 (9x)

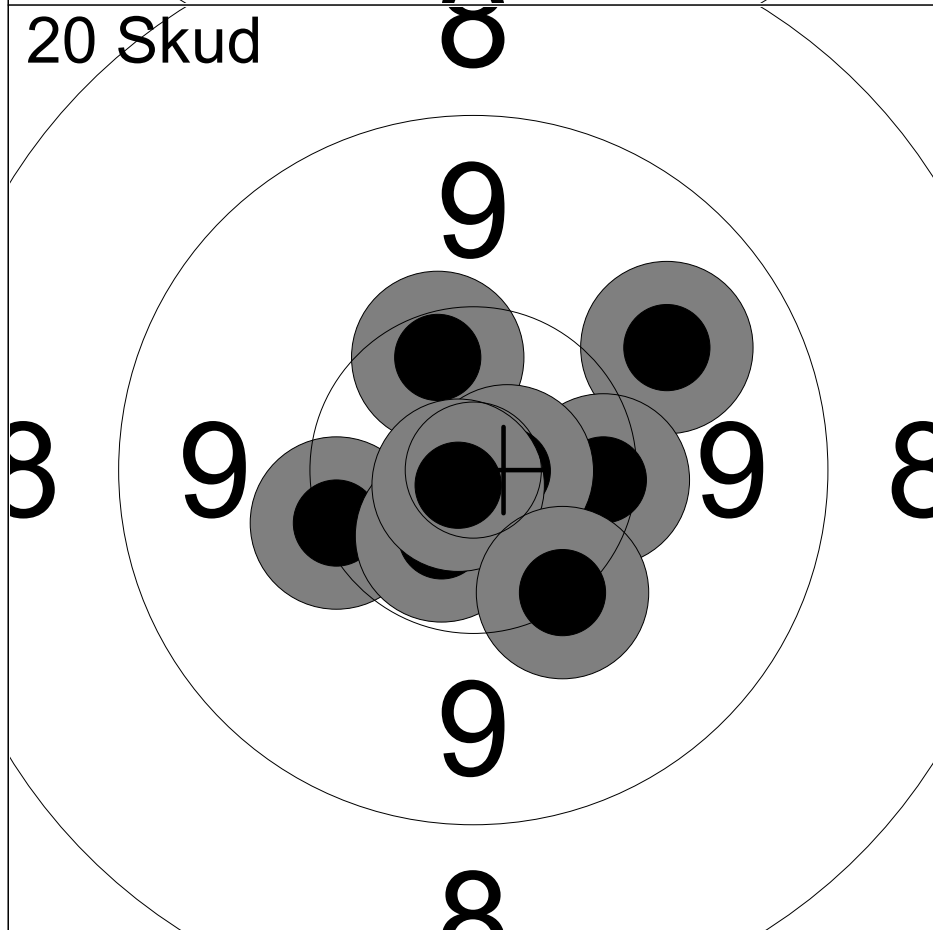

11:	10.4	↖
12:	9.8	↗
13:	10.4x	→
14:	10.2	←
15:	10.7x	↓
16:	10.3	→
17:	10.6x	↙
18:	10.8x	→
19:	10.8x	↙
20:	10.2	↘
Serie		99 (5x)
Total		199 (14x)

Hold 19	Skive 7	Linus Zvirblis	
50M	Blovstrød SG&I - Skytteafd.	ST3	
10.08.2024	EM 2024	Hanebjerg Skyttecenter	
Kommentar	Signatur		

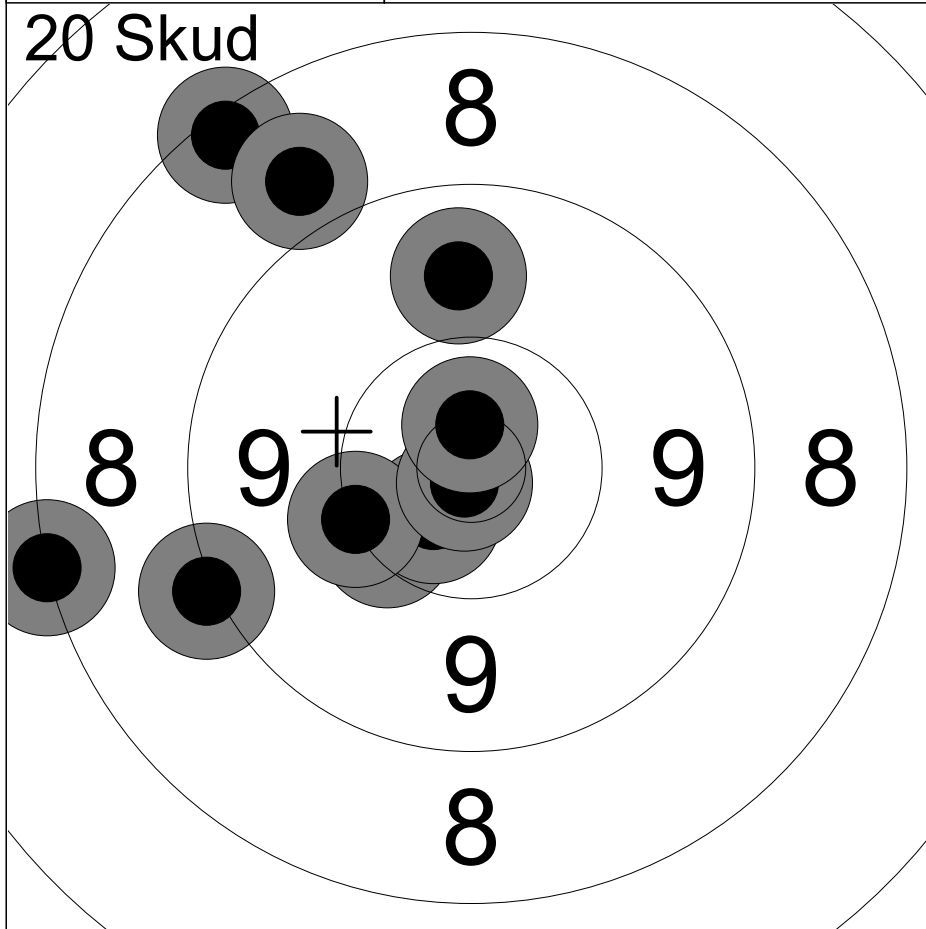

1:	9.1	↙
2:	8.3	↗
3:	8.8	↗
4:	8.2	↙
5:	9.8	↑
6:	10.3	↙
7:	10.6x	↙
8:	10.2	↙
9:	10.8x	↘
10:	10.7x	↑

Serie	92 (3x)
Total	92 (3x)

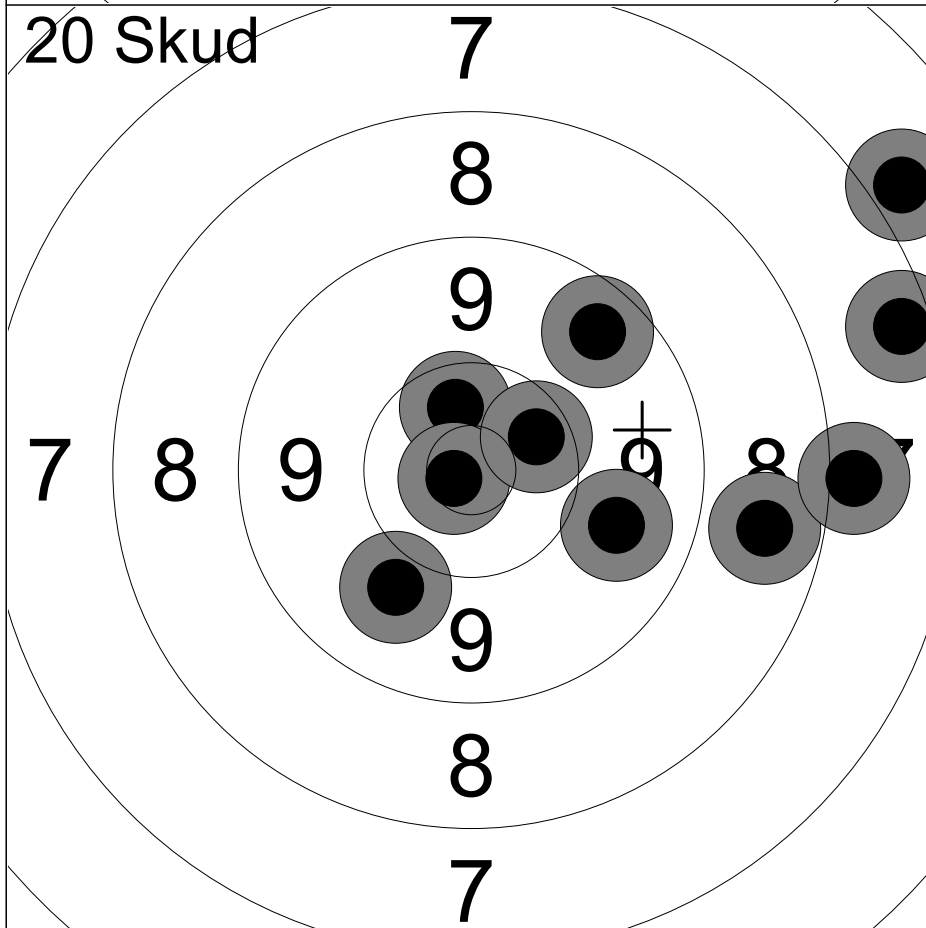

11:	9.8	→
12:	9.5	↗
13:	10.5x	↑
14:	10.8x	↙
15:	10.4	↗
16:	9.9	↘
17:	7.4	→
18:	6.9	↗
19:	8.6	→
20:	8.0	→

Serie	86 (2x)
Total	178 (5x)

Hold 19	Skive 8	Rasmus Baasch Vannaskoski	
50M		Blovstrød SG&I - Skytteafd.	J2
10.08.2024		EM 2024	Hanebjerg Skyttecenter
Kommentar		Signatur	

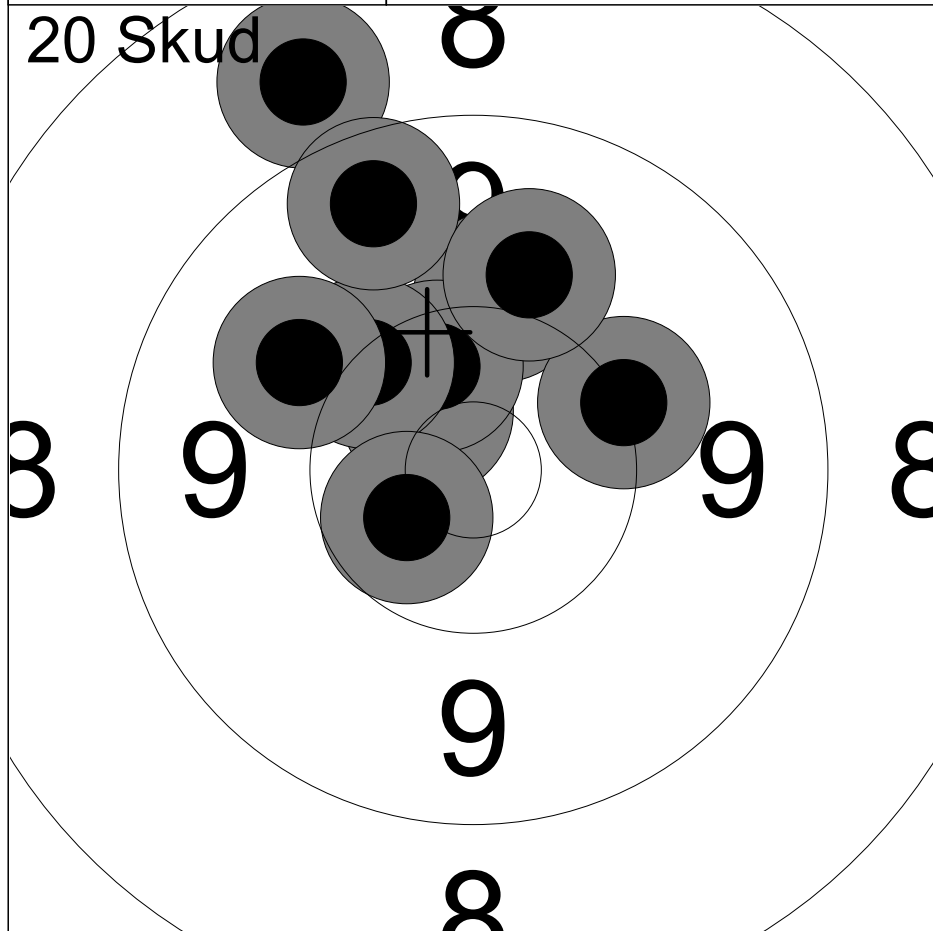

1:	10.6x	↗
2:	10.1	↑
3:	10.4x	↗
4:	8.8	↗
5:	10.2	↗
6:	10.6x	↖
7:	10.1	↗
8:	9.5	↗
9:	10.0	↗
10:	10.0	↖
Serie		97 (3x)
Total		97 (3x)

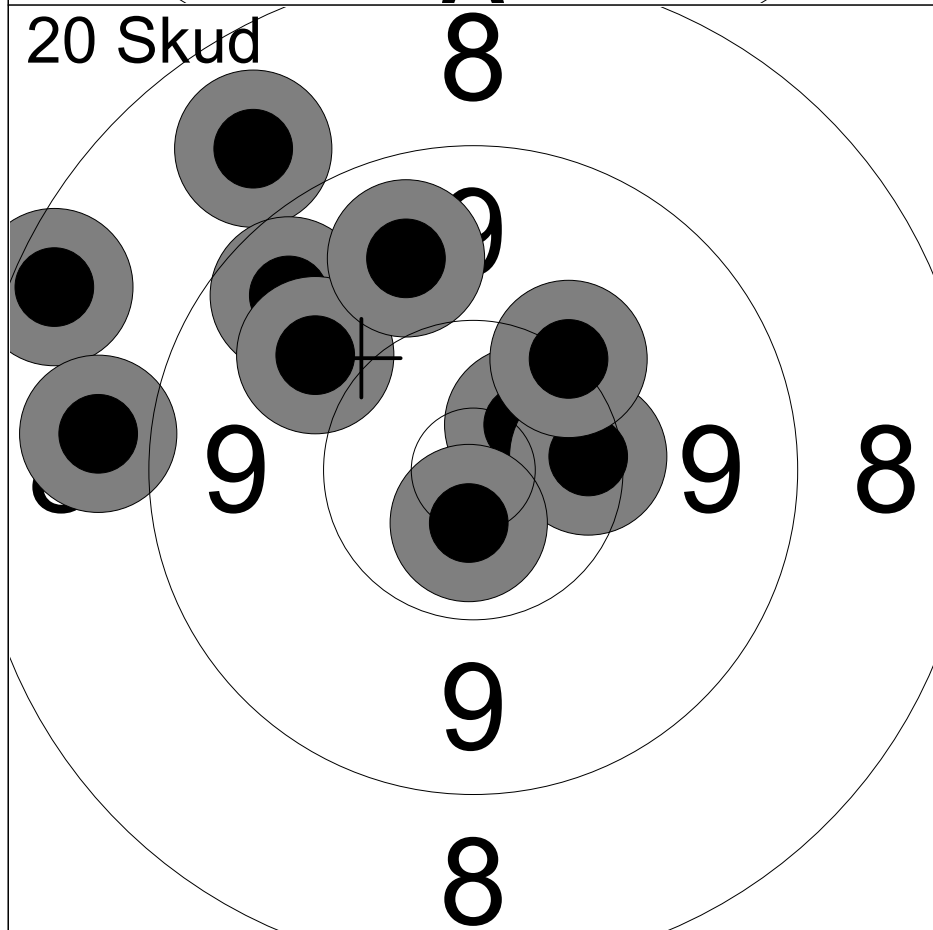

11:	8.8	↗
12:	10.6x	↗
13:	10.3	→
14:	9.6	↗
15:	9.9	↗
16:	8.4	↖
17:	10.7x	↓
18:	9.8	↗
19:	10.2	↗
20:	8.9	←
Serie		91 (2x)
Total		188 (5x)

Hold 19	Skive 10	Alexander Hunt Loeth	
50M		Blovstrød SG&I - Skytteafd.	BK3
10.08.2024		EM 2024	Hanebjerg Skyttecenter
Kommentar		Signatur	

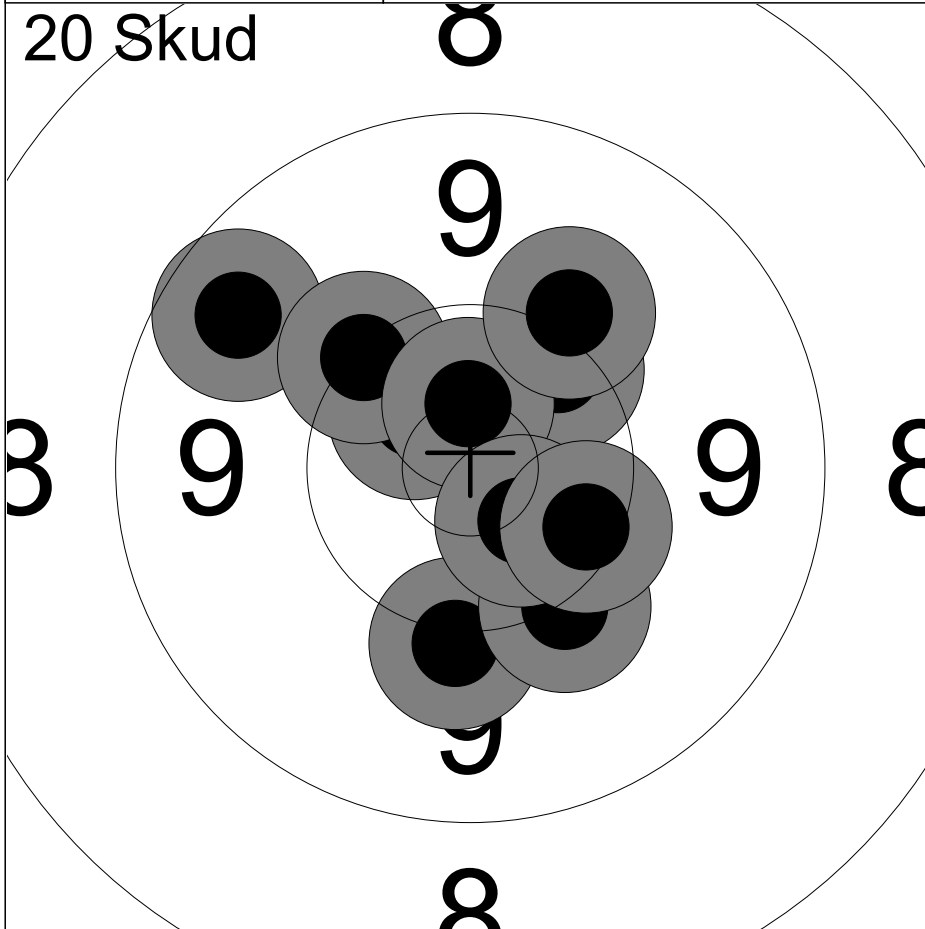

1:	10.1	↓
2:	9.6	↖
3:	10.6x	↗
4:	10.3	↗
5:	10.2	↗
6:	10.6x	↑
7:	10.1	↓
8:	10.6x	↓
9:	10.3	↘
10:	10.1	↗
Serie		99 (3x)
Total		99 (3x)

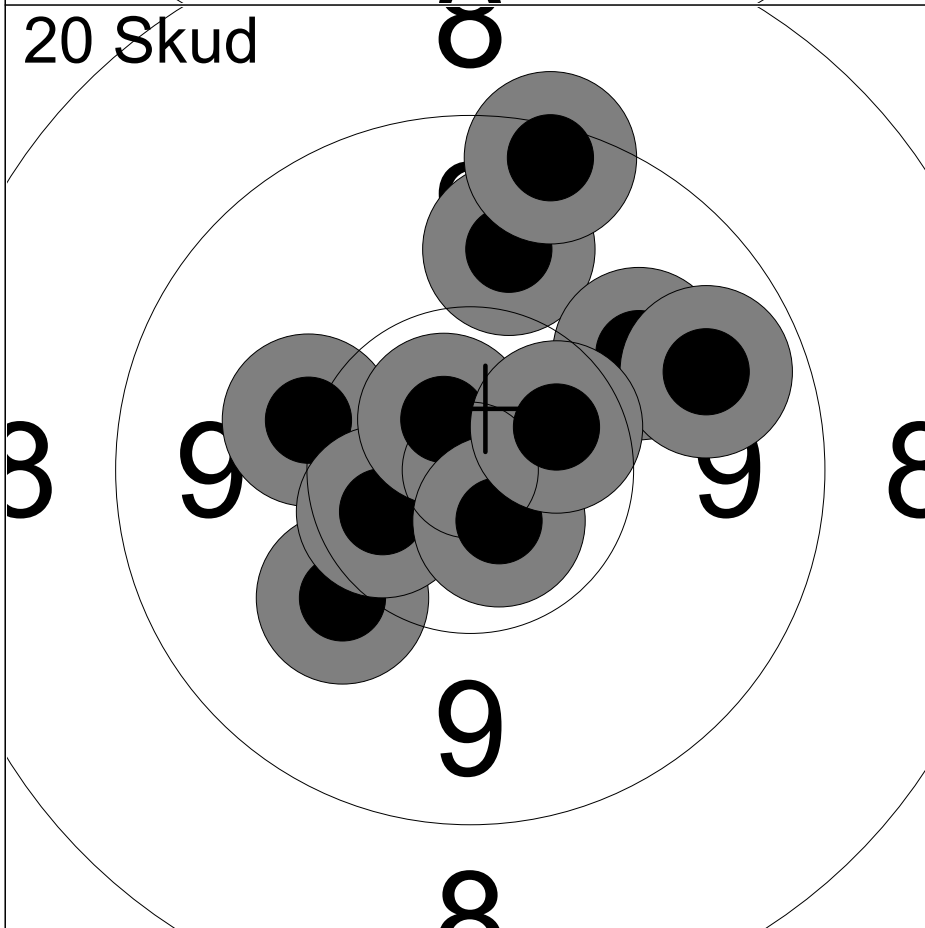

11:	9.9	↑
12:	9.3	↑
13:	10.1	↖
14:	10.1	↖
15:	10.5x	↖
16:	10.0	↗
17:	10.7x	↗
18:	10.7x	↓
19:	9.7	↗
20:	10.5x	↗
Serie		97 (4x)
Total		196 (7x)

Hold 20	Skive 1	Bjoern Thomsen	
50M		Ganløse Skytteforening	MÅ1
10.08.2024		EM 2024	Hanebjerg Skyttecenter
Kommentar		Signatur	

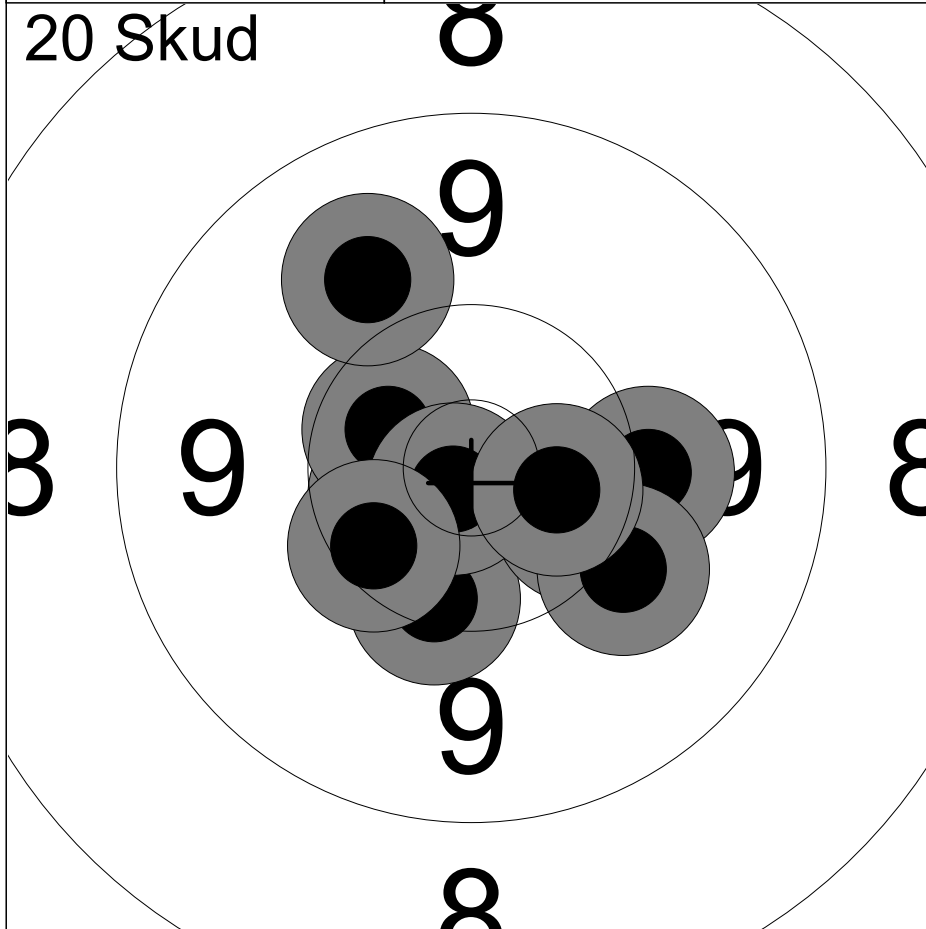

1:	10.6x	←
2:	10.3	↓
3:	10.4	↘
4:	10.1	→
5:	10.5x	↗
6:	9.9	↗
7:	10.1	↘
8:	10.8x	↘
9:	10.3	←
10:	10.5x	→
Serie		99 (4x)
Total		99 (4x)

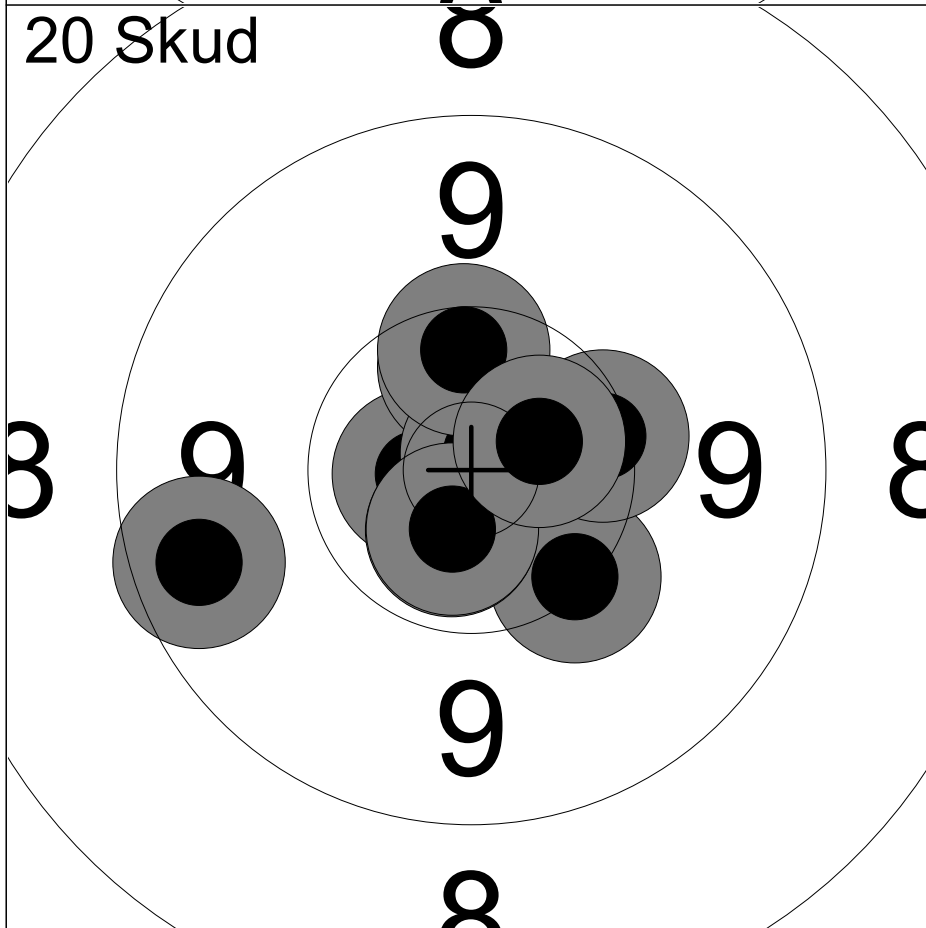

11:	10.2	↘
12:	10.7x	←
13:	10.4x	↑
14:	10.6x	↓
15:	10.3	→
16:	10.8x	↗
17:	10.7x	↓
18:	9.5	←
19:	10.4	↑
20:	10.6x	↗
Serie		99 (6x)
Total		198 (10x)

Hold 20	Skive 2	Agnete Soerensen		
50M	Frederikssund Skytteforening, I		MÅ1	
10.08.2024	EM 2024	Hanebjerg Skyttecenter		
Kommentar	Signatur			

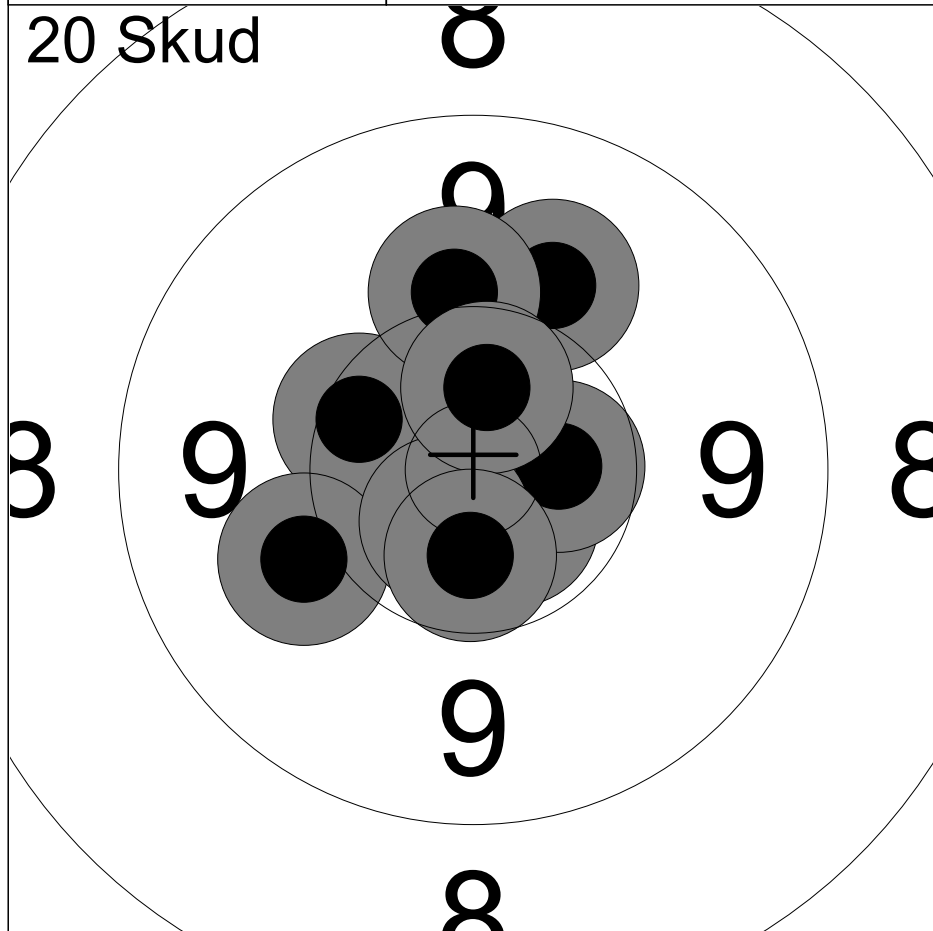

1:	10.6x	↓
2:	10.0	↗
3:	10.3	↖
4:	10.6x	↘
5:	10.1	↑
6:	10.5x	→
7:	10.0	↙
8:	10.7x	↘
9:	10.5x	↑
10:	10.5x	↓
Serie		100 (6x)
Total		100 (6x)

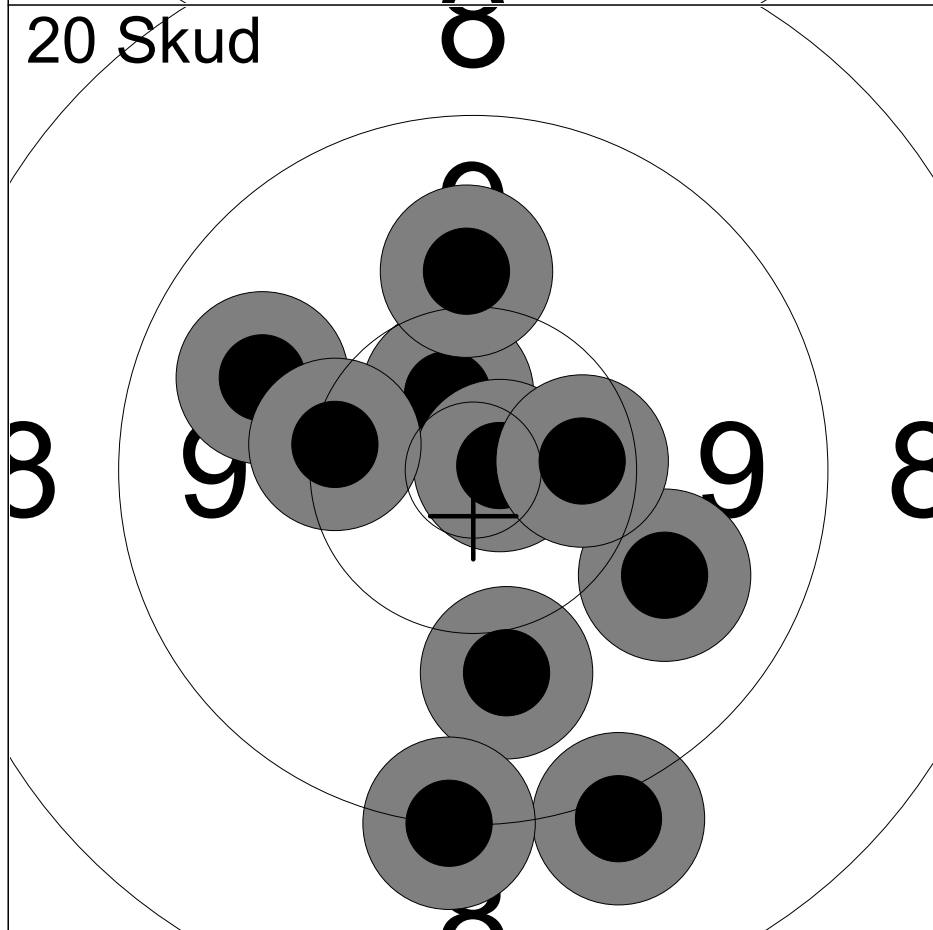

11:	10.6x	↖
12:	10.0	↑
13:	10.0	↓
14:	9.1	↘
15:	10.8x	→
16:	9.8	↖
17:	9.2	↓
18:	9.9	↘
19:	10.3	↖
20:	10.4x	→
Serie		96 (3x)
Total		196 (9x)

Hold 20	Skive 7	Anton Ellegaard Soerensen	
50M	Kreds 57, Ferslev, Skibby	MÅ1	
10.08.2024	EM 2024	Hanebjerg Skyttecenter	
Kommentar	Signatur		

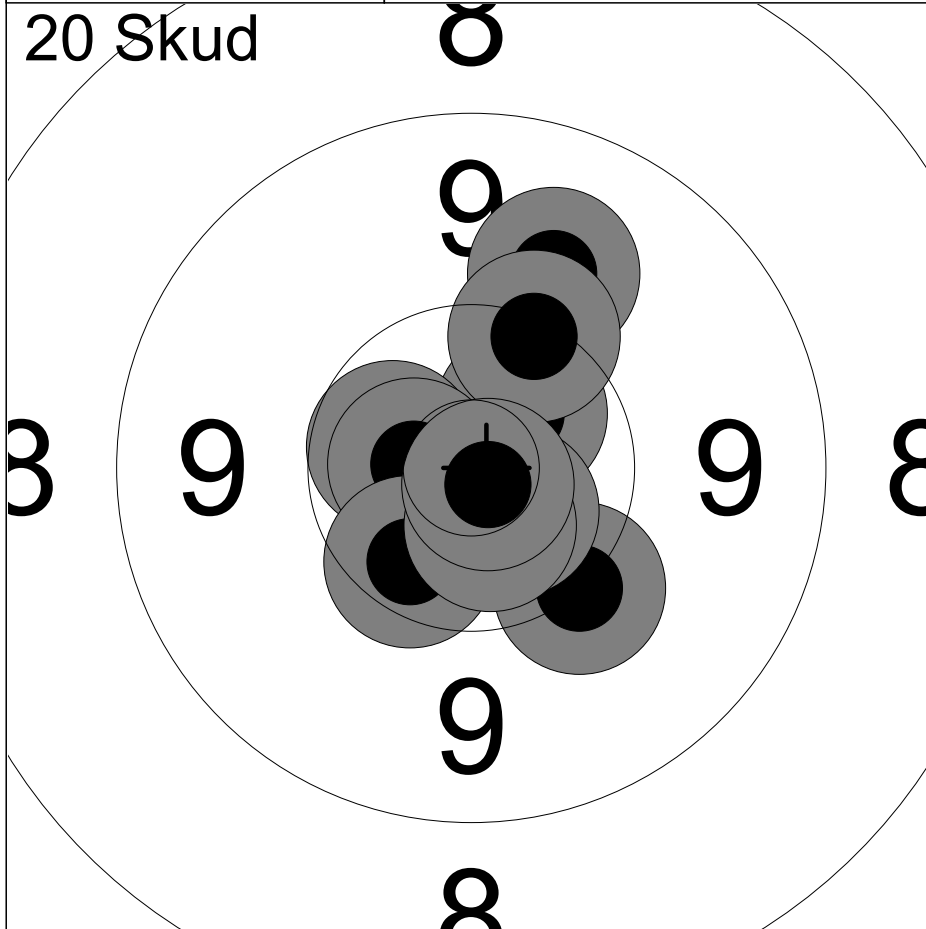

1:	10.6x	↗
2:	10.6x	↖
3:	10.2	↘
4:	10.7x	↖
5:	10.4	↘
6:	9.9	↗
7:	10.7x	↘
8:	10.7x	↘
9:	10.2	↗
10:	10.8x	↘
Serie		99 (6x)
Total		99 (6x)



11:	10.5x	→
12:	10.5x	↘
13:	10.3	↘
14:	10.5x	↑
15:	10.1	↘
16:	10.6x	→
17:	10.5x	↘
18:	10.4	↗
19:	10.2	↗
20:	10.3	↓
Serie		100 (5x)
Total		199 (11x)

Hold 20	Skive 10	Ida Aaslev Noerager Bay	
50M		Ølstykke Skytteforening	ST3
10.08.2024		EM 2024	Hanebjerg Skyttecenter
Kommentar		Signatur	



1:	10.3	↙
2:	10.7x	↙
3:	10.6x	↓
4:	10.7x	↓
5:	10.8x	↗
6:	10.6x	↙
7:	10.2	→
8:	10.5x	↘
9:	10.6x	↘
10:	10.4x	↑
Serie		100 (8x)
Total		100 (8x)

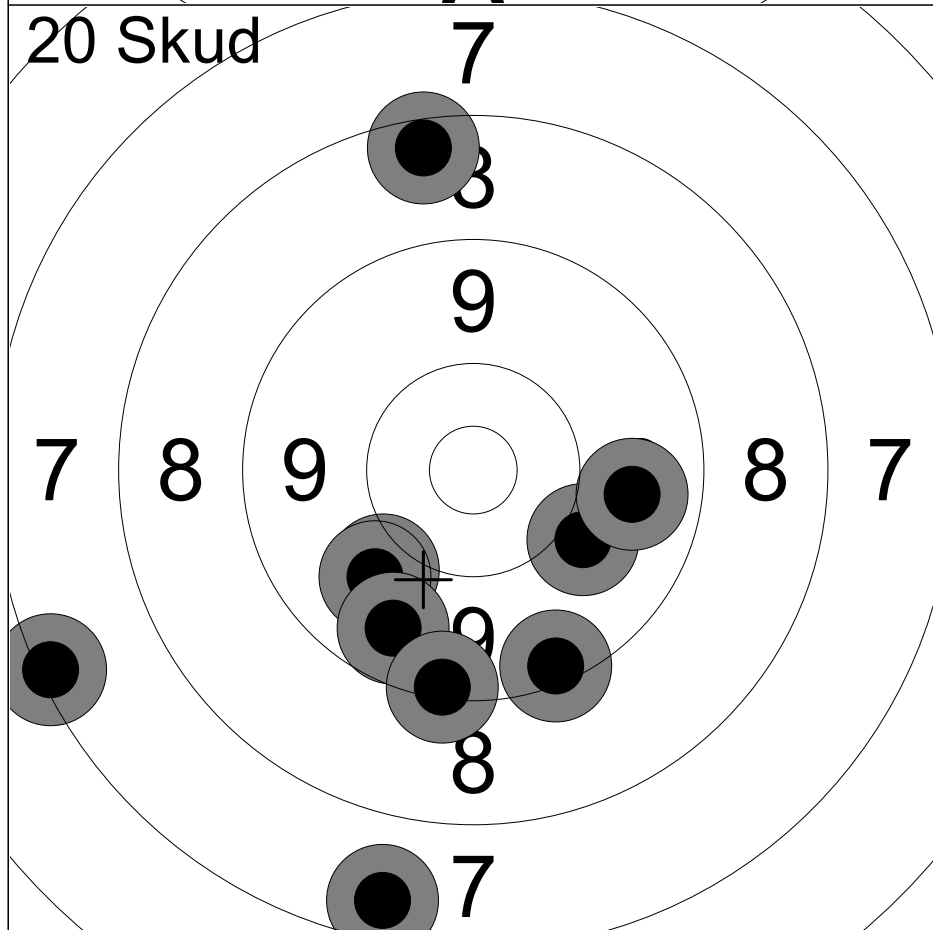

11:	7.3	↙
12:	9.3	↓
13:	10.0	↘
14:	9.9	↙
15:	7.5	↓
16:	9.9	↙
17:	9.7	→
18:	9.6	↘
19:	9.3	↓
20:	8.4	↑
Serie		86 (0x)
Total		186 (8x)

Hold 21	Skive 1	René Andersen		
50M		Ølstykke Skytteforening		MÅ1
10.08.2024		EM 2024		Hanebjerg Skyttecenter
Kommentar		Signatur		

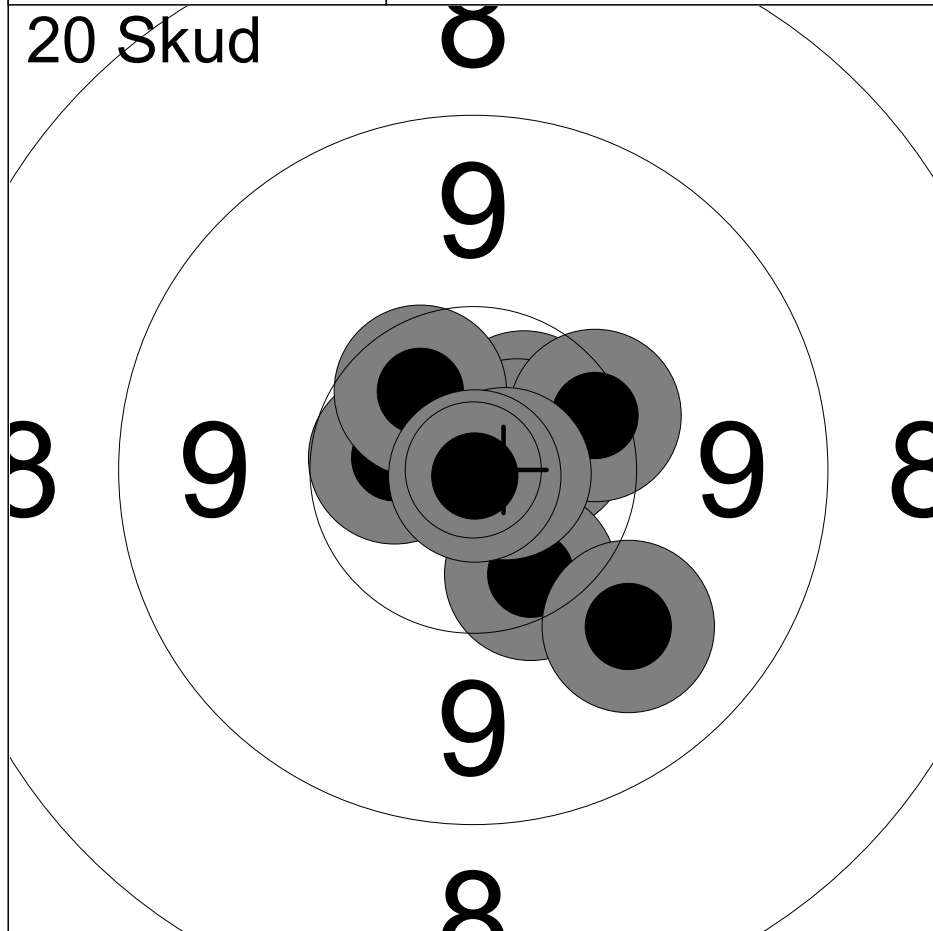

1:	10.6x	↗
2:	10.6x	←
3:	10.6x	↗
4:	10.7x	↗
5:	10.4	↘
6:	10.3	↗
7:	9.9	↘
8:	10.5x	↗
9:	10.8x	→
10:	10.9x	↘
Serie		99 (7x)
Total		99 (7x)



11:	10.4	↘
12:	10.6x	↗
13:	10.6x	↗
14:	10.8x	↘
15:	10.3	↘
16:	10.5x	←
17:	10.3	←
18:	10.7x	↘
19:	10.1	↗
20:	10.6x	↖
Serie		100 (6x)
Total		199 (13x)

Hold 21	Skive 4	Freya Kofoed	
50M	Østerlars Skytteforening	ST2	
10.08.2024	EM 2024	Hanebjerg Skyttecenter	
Kommentar	Signatur		

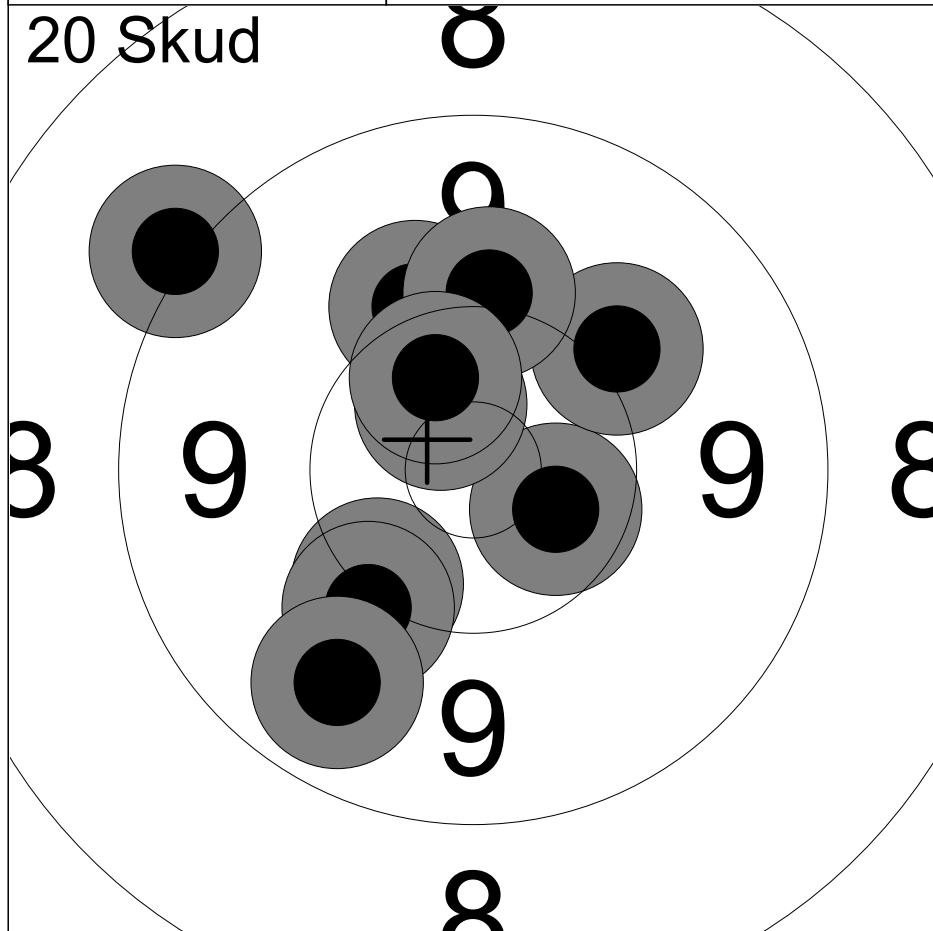

1:	10.1	↖
2:	10.5x	→
3:	10.2	↙
4:	10.6x	↖
5:	10.1	↙
6:	9.1	↖
7:	9.7	↙
8:	10.0	↗
9:	10.1	↖
10:	10.5x	↖
Serie		98 (3x)
Total		98 (3x)

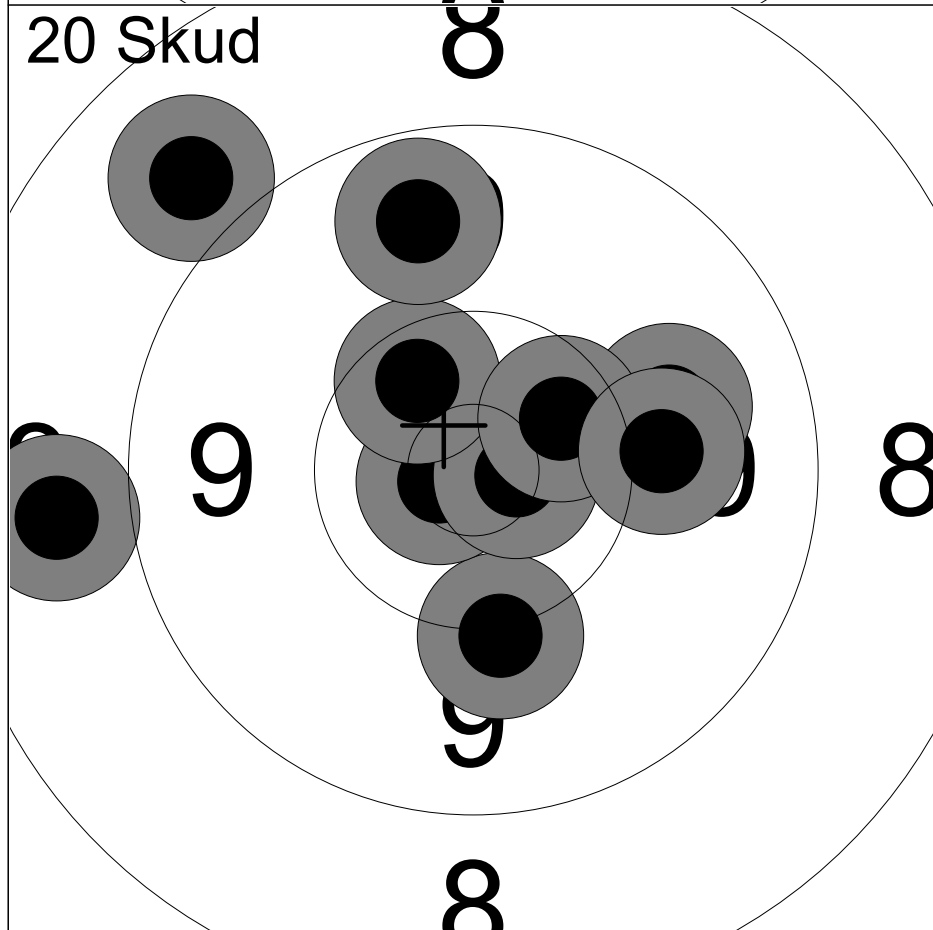

11:	10.1	↓
12:	10.8x	←
13:	10.7x	→
14:	9.9	↗
15:	10.4x	↖
16:	8.8	↖
17:	9.7	↖
18:	10.4x	↗
19:	8.8	←
20:	10.0	→
Serie		94 (4x)
Total		192 (7x)

Hold 21	Skive 7	Linas Zvirblis		
50M		Bløvstrød SG&I - Skytteafd.		MST3
10.08.2024		EM 2024		Hanebjerg Skyttecenter
Kommentar		Signatur		

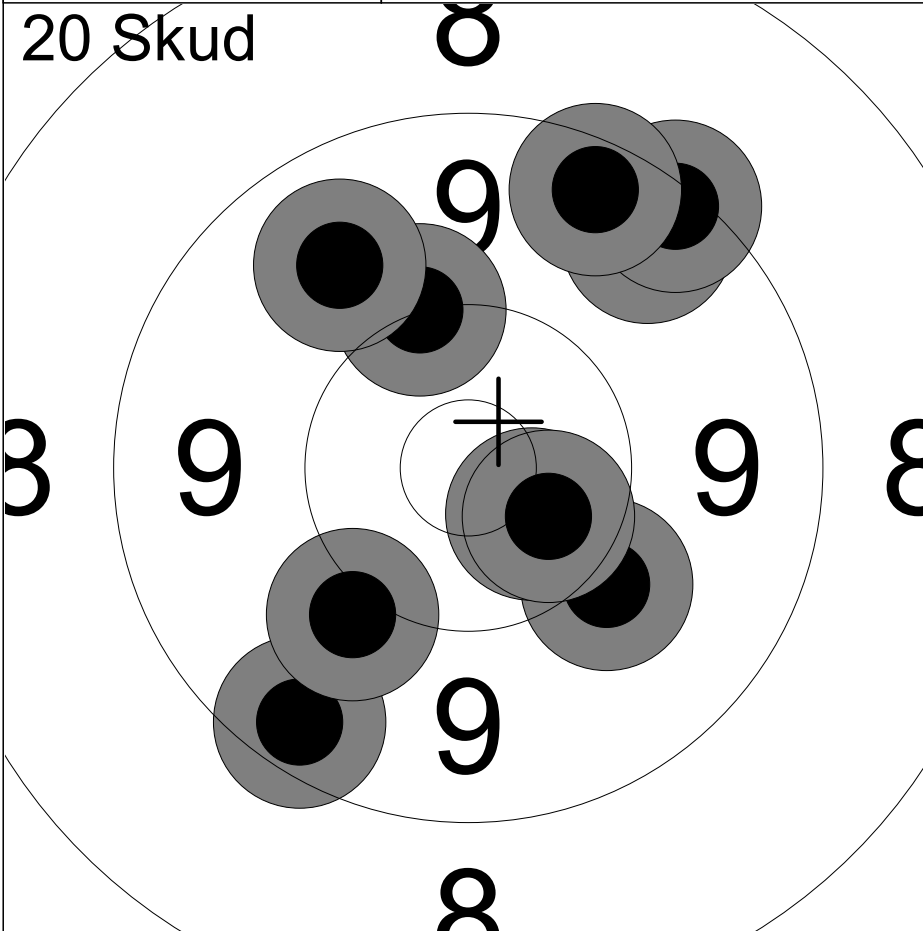

1:	9.4	↙
2:	10.1	↘
3:	9.5	↗
4:	9.3	↗
5:	9.4	↗
6:	10.6x	↘
7:	10.5x	↘
8:	10.1	↗
9:	10.0	↙
10:	9.8	↗
Serie		95 (2x)
Total		95 (2x)

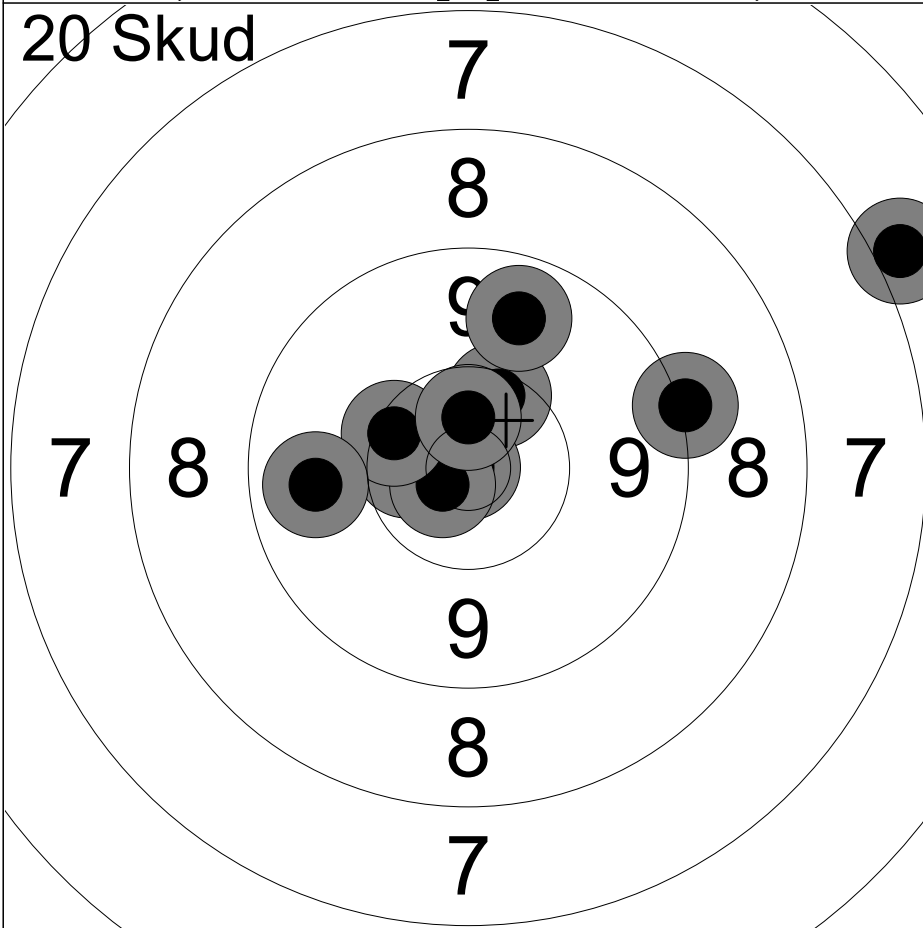

11:	10.3	↗
12:	10.9x	↖
13:	10.5x	←
14:	10.7x	↖
15:	10.3	↖
16:	9.7	↗
17:	9.7	←
18:	9.1	→
19:	10.6x	↑
20:	7.0	↗
Serie		94 (4x)
Total		189 (6x)

Hold 21	Skive 8	Rasmus Baasch Vannaskoski	
50M	Blovstrød SG&I - Skytteafd.	MJ2	
10.08.2024	EM 2024	Hanebjerg Skyttecenter	
Kommentar	Signatur		

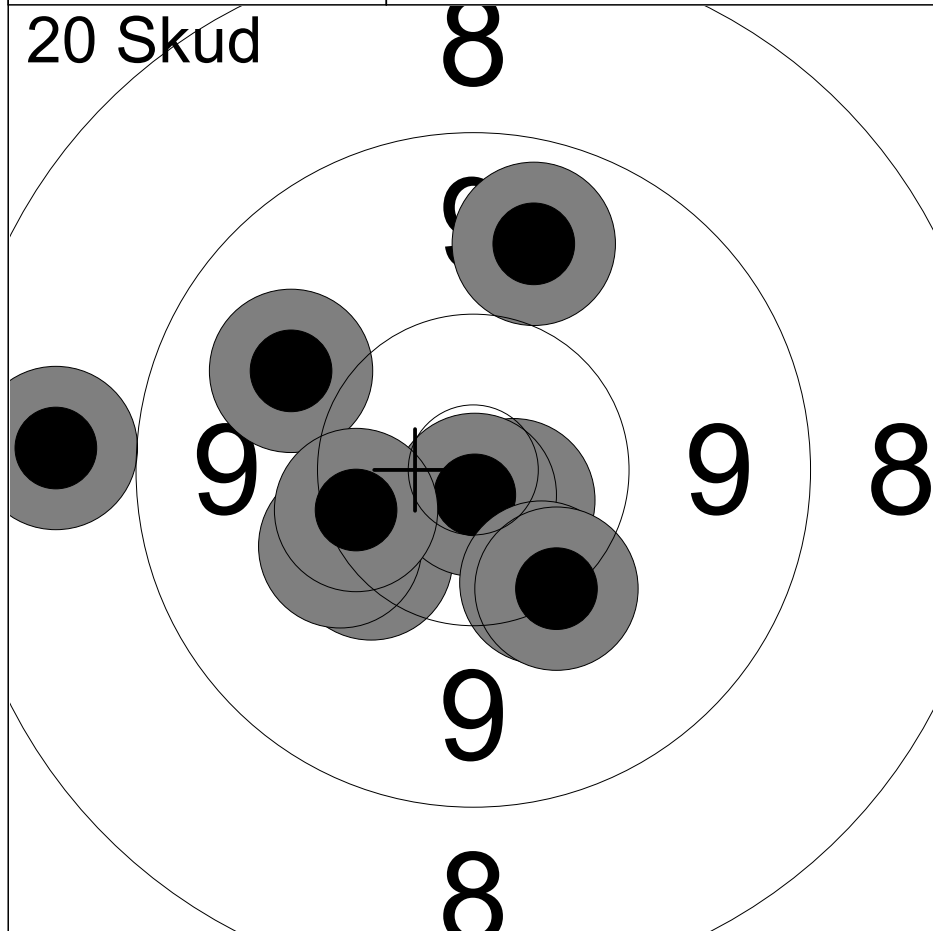

1:	10.3	↙
2:	10.7x	↘
3:	8.7	←
4:	10.2	↙
5:	9.9	↖
6:	10.8x	↓
7:	9.7	↑
8:	10.3	↘
9:	10.2	↘
10:	10.3	↙
Serie		96 (2x)
Total		96 (2x)

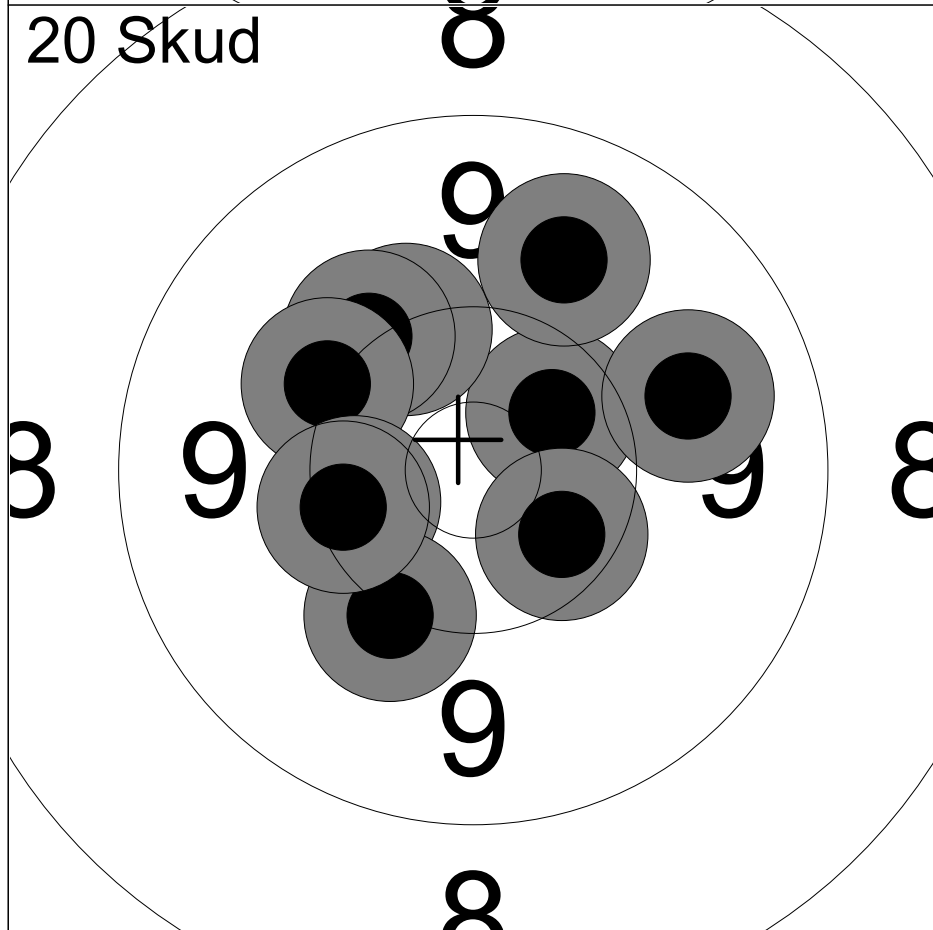

11:	10.5x	↗
12:	10.2	↖
13:	10.1	↖
14:	10.4x	↘
15:	9.8	↗
16:	9.8	→
17:	10.1	↙
18:	10.4	←
19:	10.1	↘
20:	10.3	↙
Serie		98 (2x)
Total		194 (4x)

Hold 21	Skive 10	Alexander Hunt Loeth	
50M	Blovstrød SG&I - Skytteafd.	MBK3	
10.08.2024	EM 2024	Hanebjerg Skyttecenter	
Kommentar	Signatur		

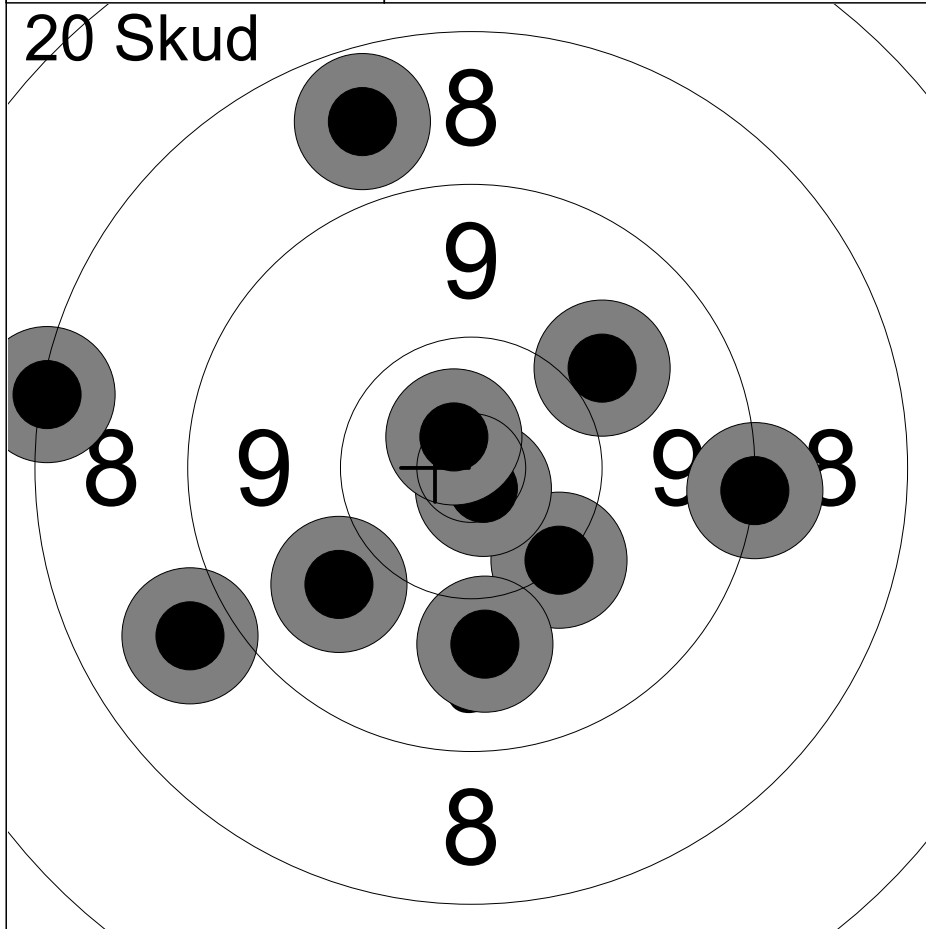

1:	10.2	↘
2:	8.2	←
3:	10.0	↗
4:	8.9	←
5:	10.8x	↘
6:	9.9	↘
7:	8.7	↗
8:	9.2	→
9:	9.9	←
10:	10.7x	↗
Serie		91 (2x)
Total		91 (2x)

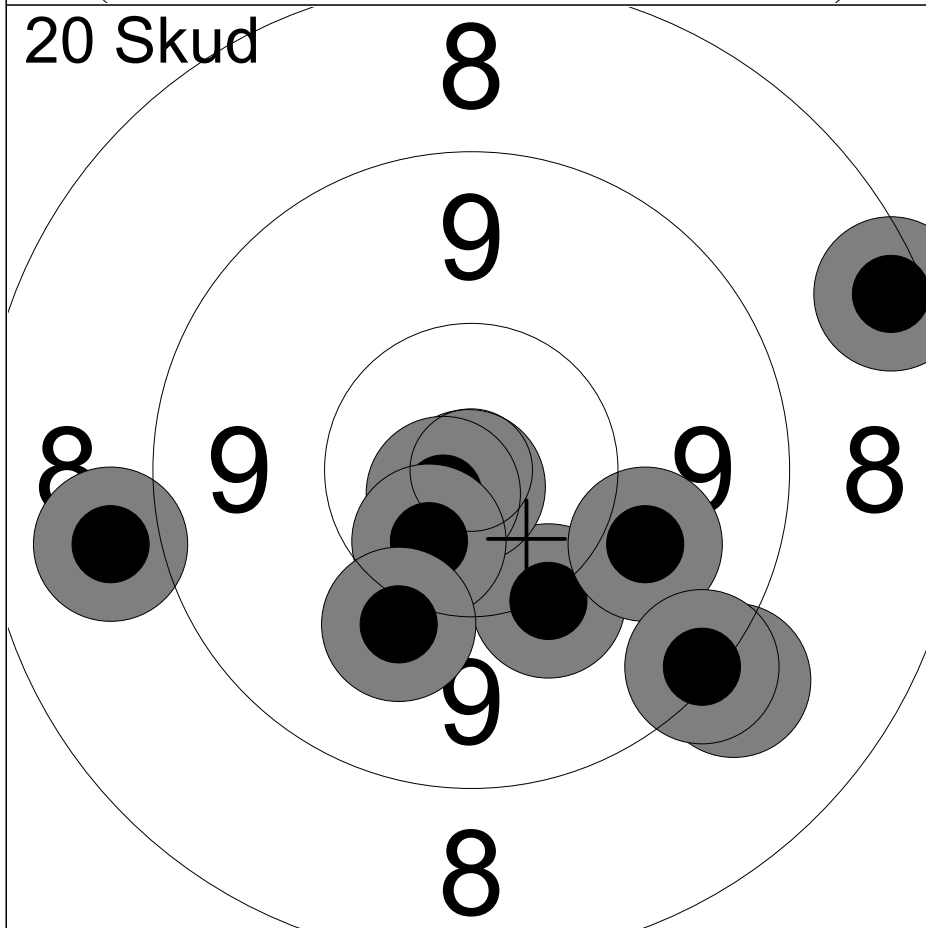

11:	10.1	↘
12:	9.1	↘
13:	10.9x	↘
14:	10.8x	←
15:	9.9	↘
16:	9.3	↘
17:	8.4	↗
18:	10.5x	↘
19:	8.9	←
20:	10.0	↘
Serie		93 (3x)
Total		184 (5x)

Hold 22	Skive 3	William Moelbak	
50M	Frederikssund Skytteforening, I	BK1	
10.08.2024	EM 2024	Hanebjerg Skyttecenter	
Kommentar	Signatur		



1:	10.4x	↓
2:	10.7x	↗
3:	10.4	↘
4:	10.0	↘
5:	10.9x	↗
6:	10.4	↗
7:	10.7x	←
8:	10.6x	→
9:	10.8x	↗
10:	10.1	↓
Serie		100 (6x)
Total		100 (6x)



11:	9.8	↗
12:	10.6x	↗
13:	10.0	↓
14:	10.4	↗
15:	10.6x	↓
16:	10.3	↓
17:	9.9	↘
18:	10.0	↘
19:	10.6x	→
20:	10.5x	↘
Serie		98 (4x)
Total		198 (10x)

Hold 22	Skive 10	Ida Aaslev Noerager Bay	
50M		Ølstykke Skytteforening	MST3
10.08.2024		EM 2024	Hanebjerg Skyttecenter
Kommentar		Signatur	

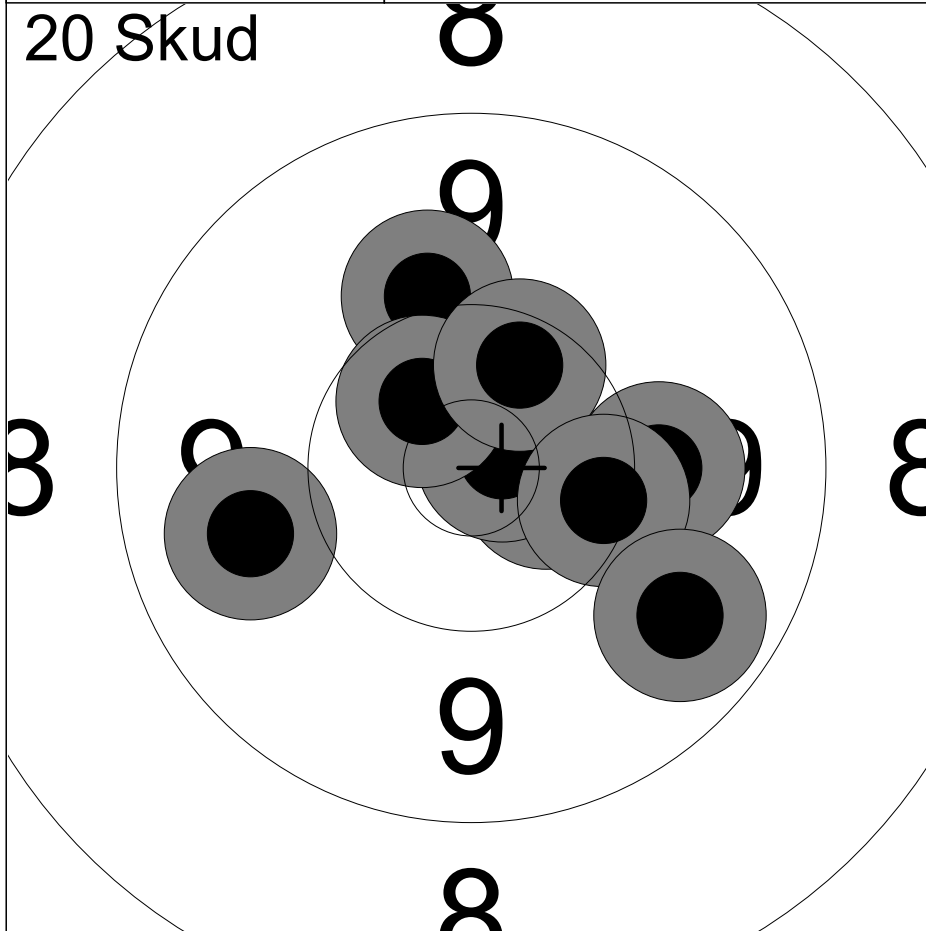

1:	10.6x	→
2:	10.8x	↗
3:	10.8x	→
4:	10.1	↑
5:	10.5x	↗
6:	9.8	←
7:	10.0	→
8:	10.4	↗
9:	10.3	→
10:	9.7	↘
Serie		98 (4x)
Total		98 (4x)

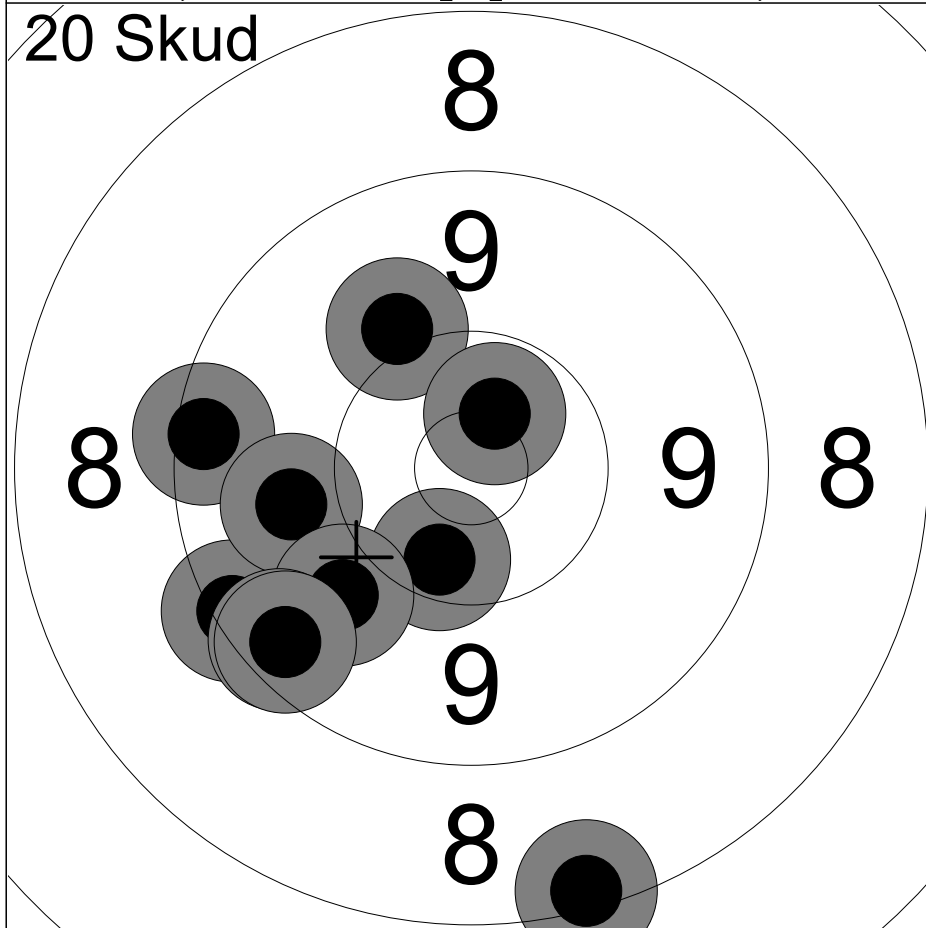

11:	10.0	↗
12:	9.3	←
13:	8.3	↘
14:	9.3	←
15:	10.4	↘
16:	9.9	←
17:	9.9	↙
18:	10.6x	↗
19:	9.4	↙
20:	9.4	↙
Serie		92 (1x)
Total		190 (5x)

Hold 22	Skive 12	Mikkel Kannik	
50M		Ølstykke Skytteforening	ST2
10.08.2024		EM 2024	Hanebjerg Skyttecenter
Kommentar		Signatur	

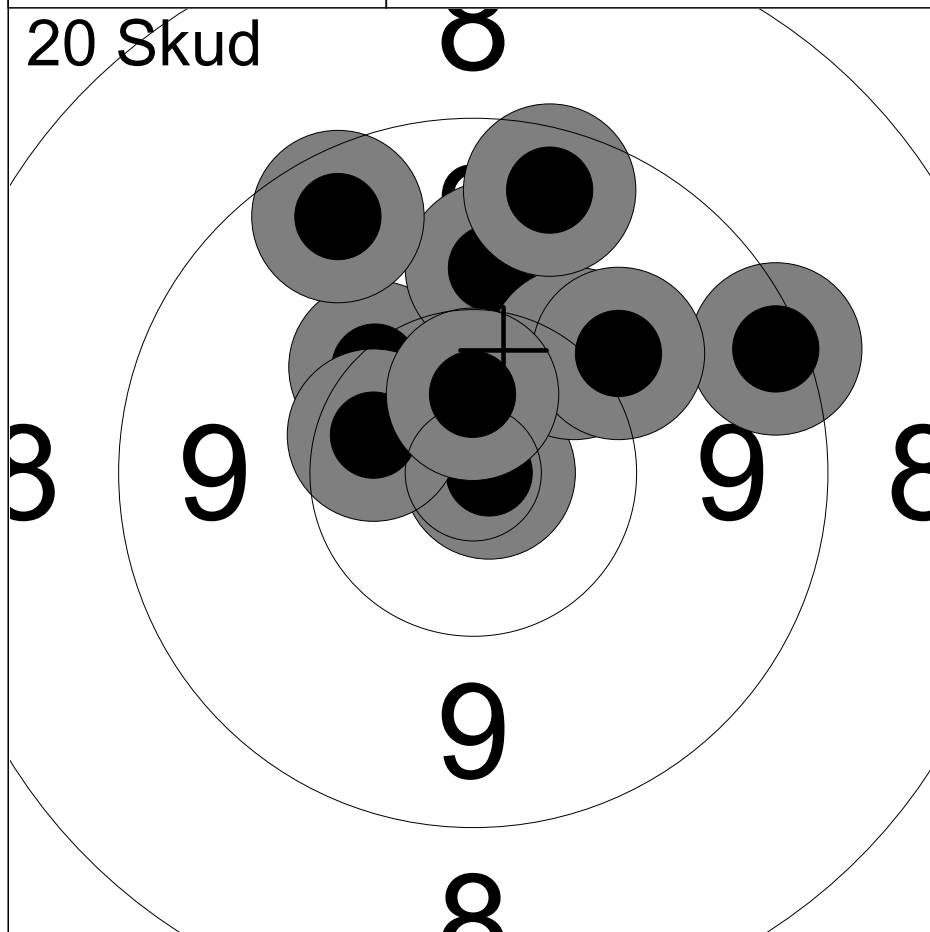

1:	9.3	↗
2:	10.9x	→
3:	10.3	↖
4:	10.0	↑
5:	10.2	↗
6:	9.5	↖
7:	9.5	↑
8:	10.0	↗
9:	10.4x	↖
10:	10.6x	↑
Serie		97 (3x)
Total		97 (3x)

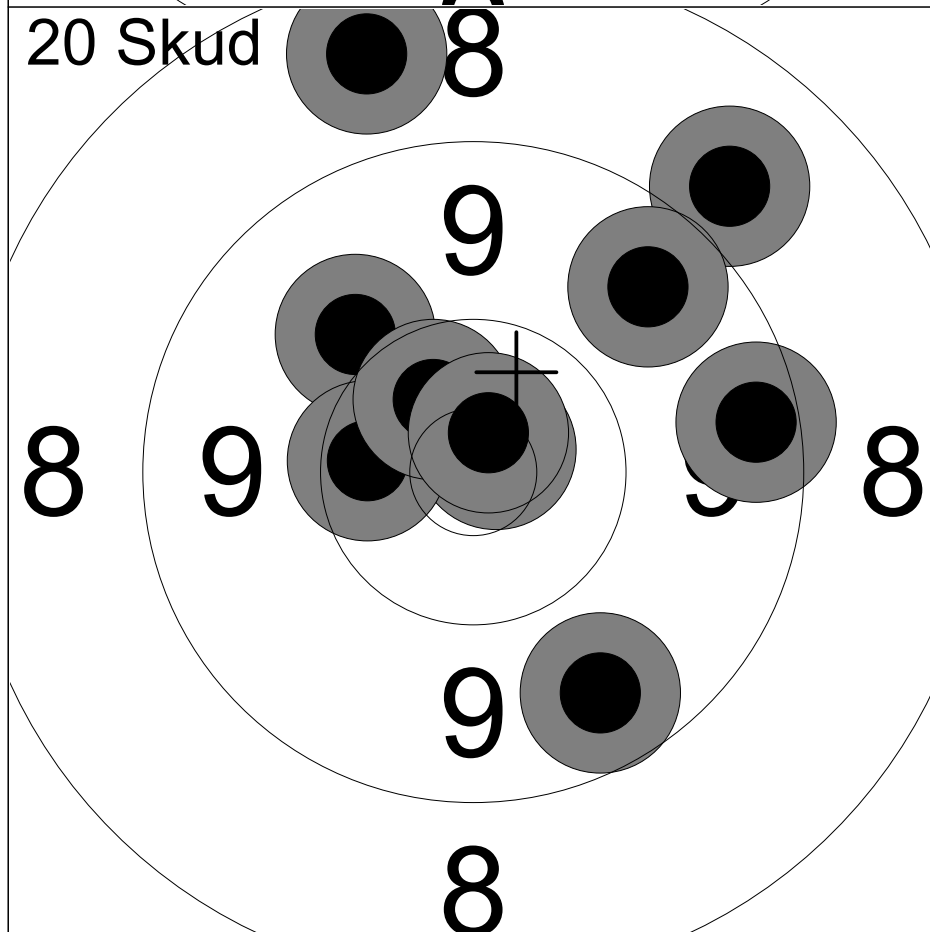

11:	10.8x	↗
12:	9.6	↘
13:	10.0	↖
14:	10.4	←
15:	10.5x	↖
16:	9.4	→
17:	8.9	↗
18:	8.6	↑
19:	9.6	↗
20:	10.7x	↗
Serie		93 (3x)
Total		190 (6x)

Hold 23	Skive 1	Magnus Bjoernberg Levisen	
50M		Ølstykke Skytteforening	J2
10.08.2024		EM 2024	Hanebjerg Skyttecenter
Kommentar		Signatur	

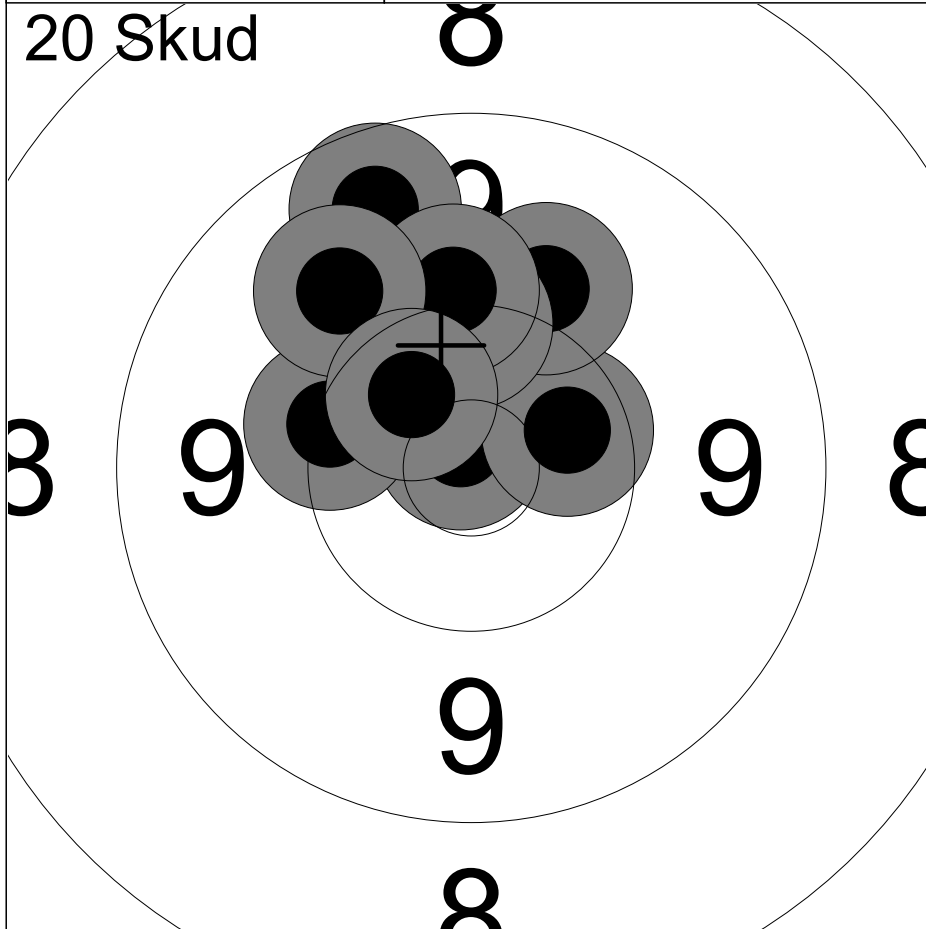

1:	10.8x	↖
2:	10.4x	↗
3:	10.0	↖
4:	10.2	↖
5:	9.8	↖
6:	10.2	↖
7:	9.6	↖
8:	10.1	↖
9:	9.9	↖
10:	10.5x	↖
Serie		97 (3x)
Total		97 (3x)

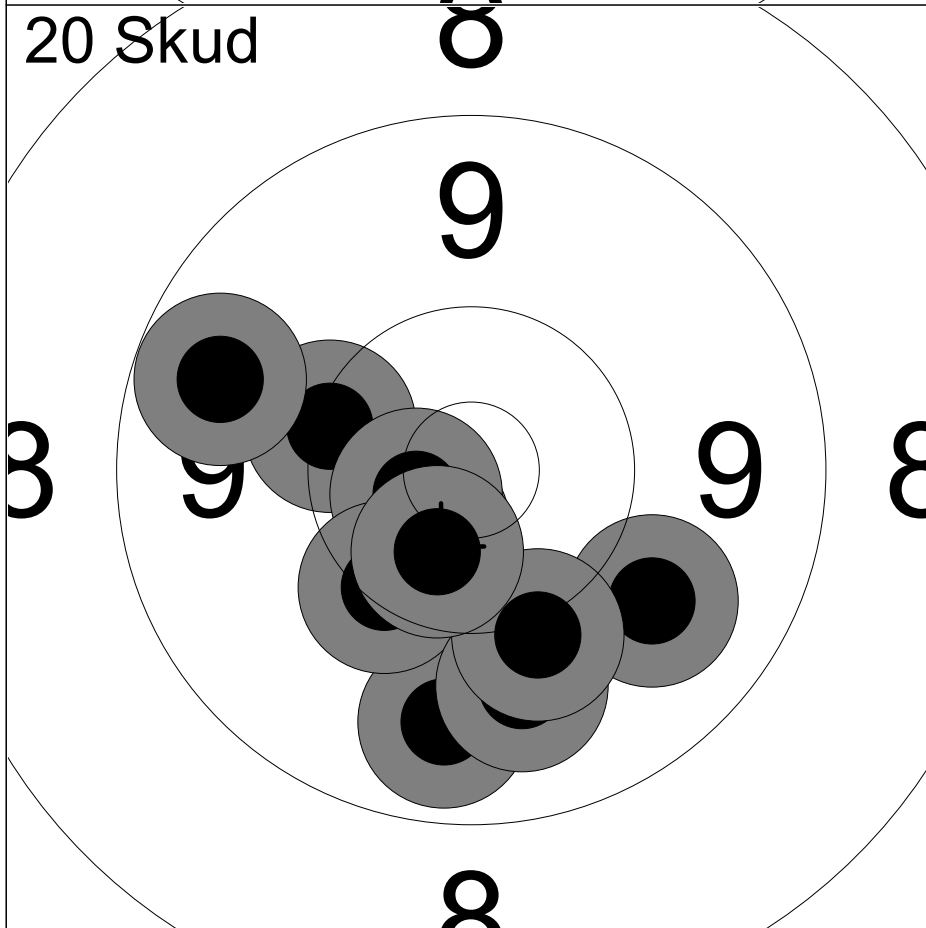

11:	10.6x	↙
12:	9.7	↘
13:	10.2	↖
14:	10.7x	↖
15:	10.2	↙
16:	9.9	↘
17:	9.6	↖
18:	9.9	↘
19:	10.1	↘
20:	10.5x	↙
Serie		96 (3x)
Total		193 (6x)

Hold 23	Skive 2	Jeppe Mygind Plaep	
50M	Ølstykke Skytteforening	BK2	
10.08.2024	EM 2024	Hanebjerg Skyttecenter	
Kommentar	Signatur		

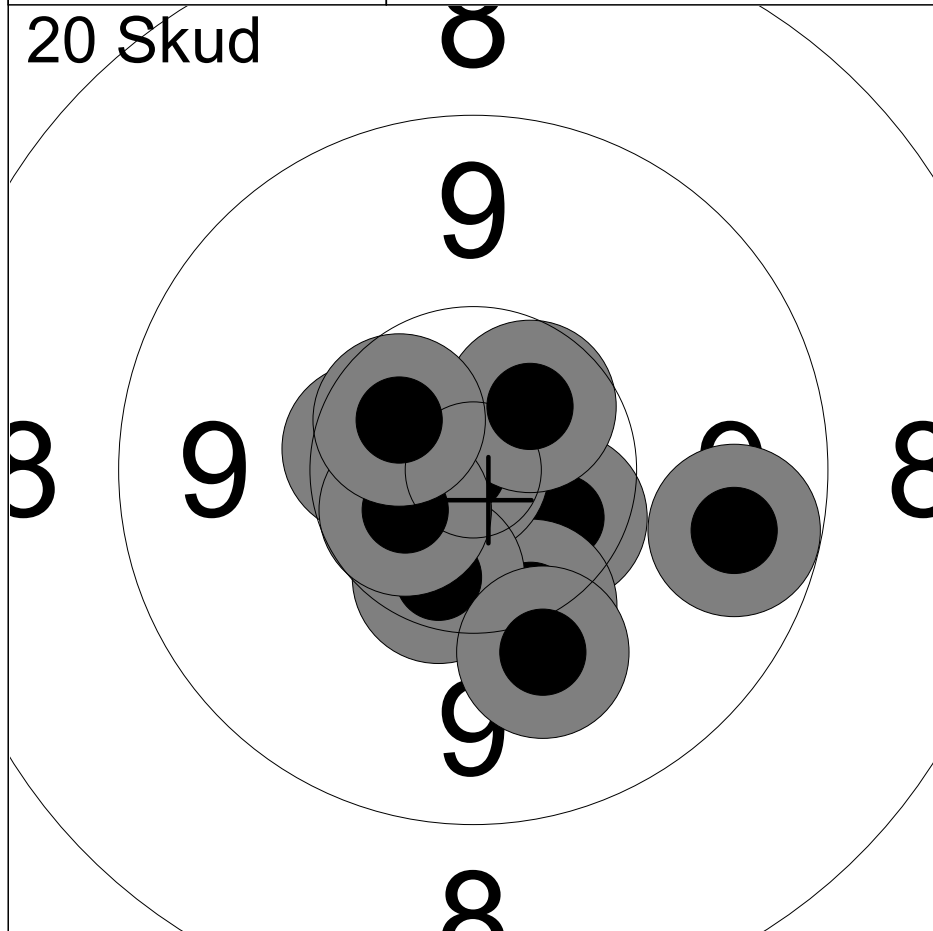

1:	10.5x	↘
2:	9.6	→
3:	10.2	↙
4:	10.9x	←
5:	10.5x	↗
6:	10.4	↙
7:	10.0	↙
8:	10.4x	←
9:	10.6x	↙
10:	10.5x	↗
Serie		99 (6x)
Total		99 (6x)

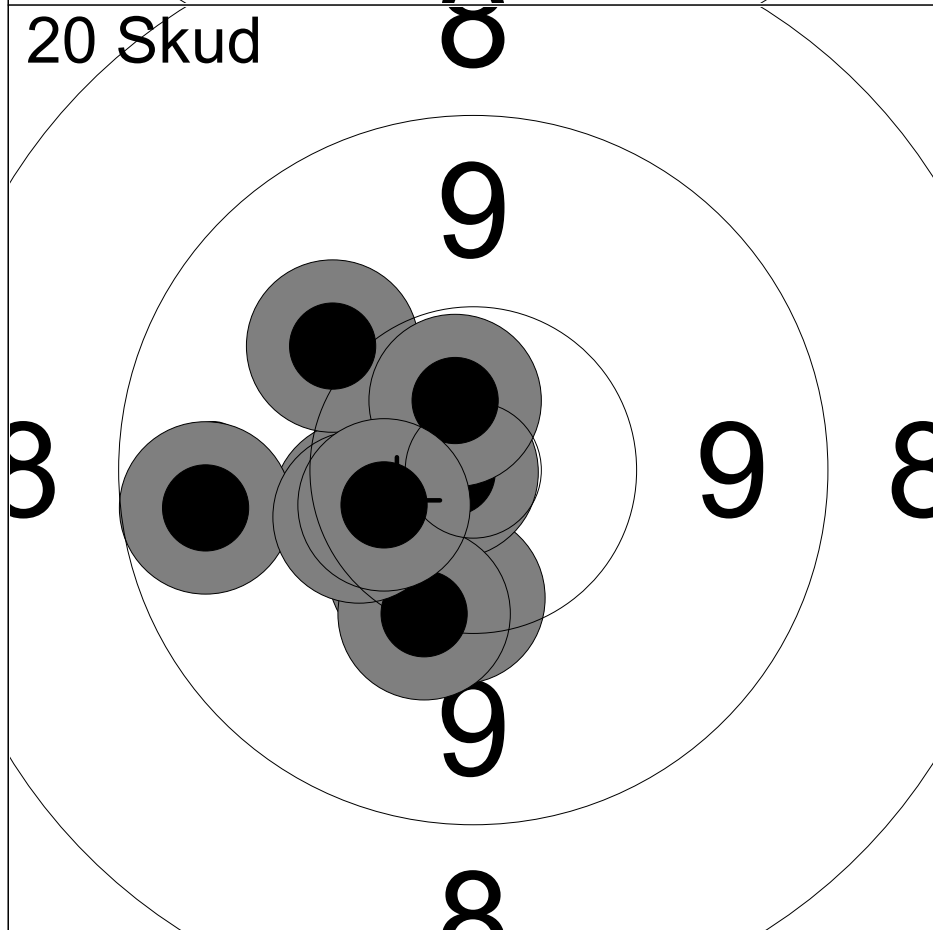

11:	10.4	↙
12:	10.4	←
13:	10.3	↙
14:	10.8x	←
15:	10.2	↙
16:	10.0	↗
17:	9.6	←
18:	10.4	↙
19:	10.6x	↗
20:	10.5x	←
Serie		99 (3x)
Total		198 (9x)

Hold 23	Skive 3	Theodor Hejnfelt	
50M	Frederikssund Skytteforening, I	BK3	
10.08.2024	EM 2024	Hanebjerg Skyttecenter	
Kommentar	Signatur		

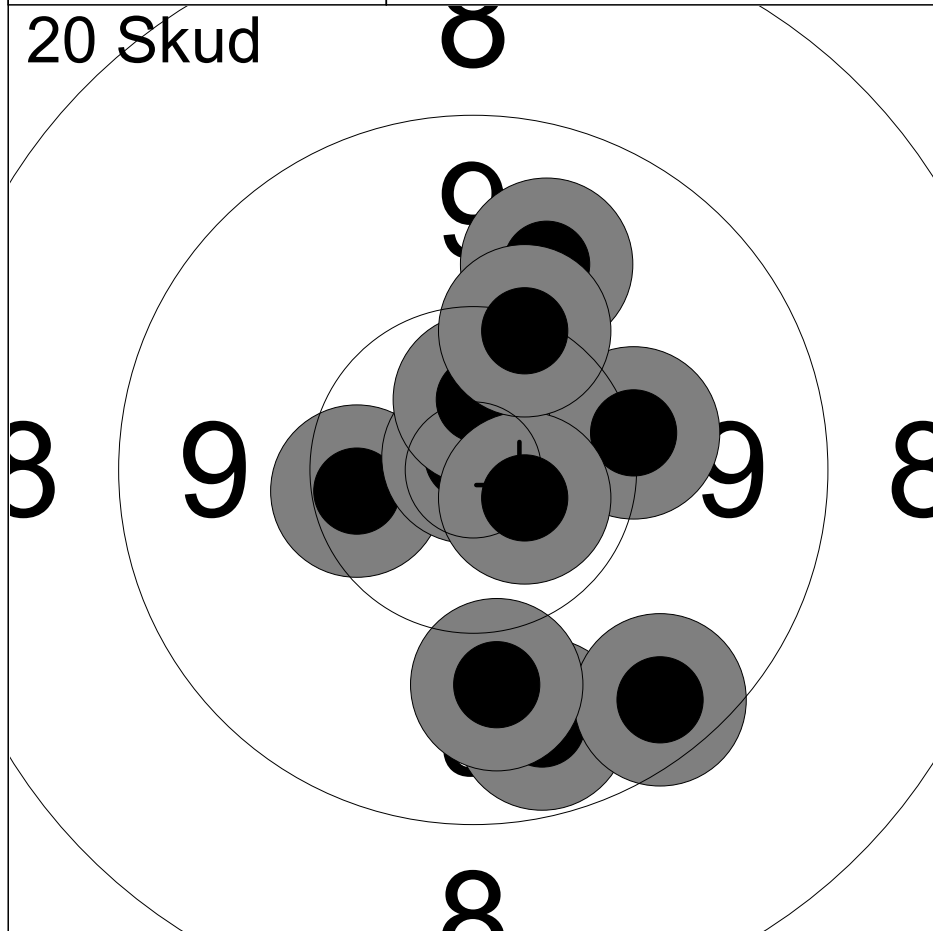

1:	10.4	←
2:	9.6	↓
3:	9.5	↘
4:	9.9	↓
5:	10.9x	↑
6:	10.6x	↑
7:	9.9	↗
8:	10.2	→
9:	10.7x	↘
10:	10.2	↑
Serie		96 (3x)
Total		96 (3x)

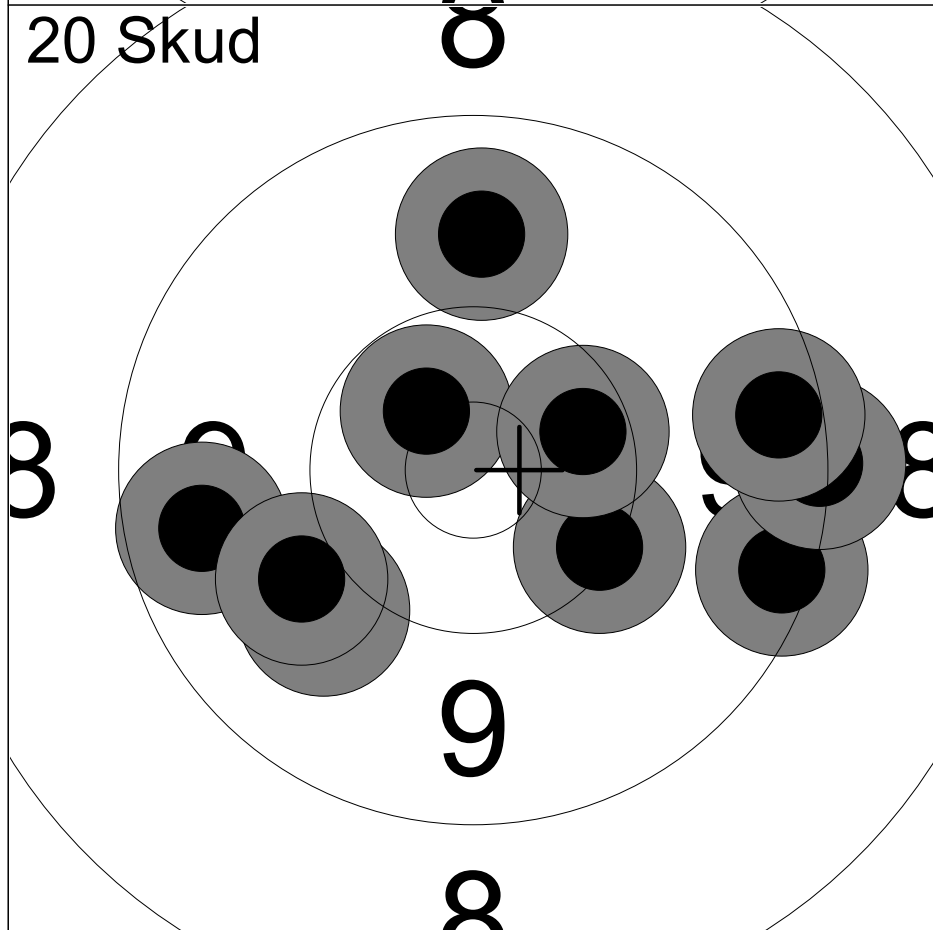

11:	10.6x	↗
12:	9.3	↘
13:	9.2	→
14:	9.4	→
15:	9.6	←
16:	10.0	↙
17:	10.2	↘
18:	9.8	↑
19:	10.0	↙
20:	10.4	→
Serie		95 (1x)
Total		191 (4x)

Hold 23	Skive 4	Freya Kofoed		
50M	Østerlars Skytteforening		MST2	
10.08.2024	EM 2024	Hanebjerg Skyttecenter		
Kommentar	Signatur			

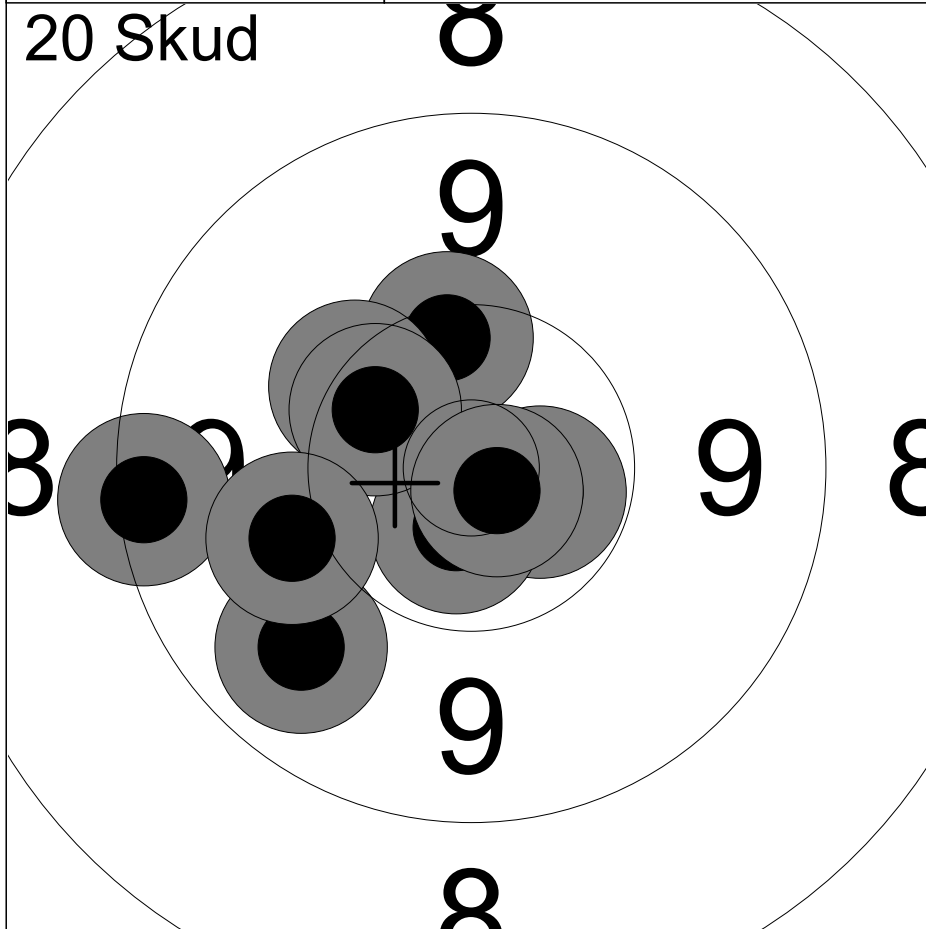

1:	10.8x	↘
2:	10.6x	↗
3:	10.6x	↘
4:	9.7	↙
5:	10.3	↗
6:	10.3	↗
7:	10.4	↗
8:	9.3	↖
9:	10.0	↖
10:	10.8x	↘
Serie		98 (4x)
Total		98 (4x)

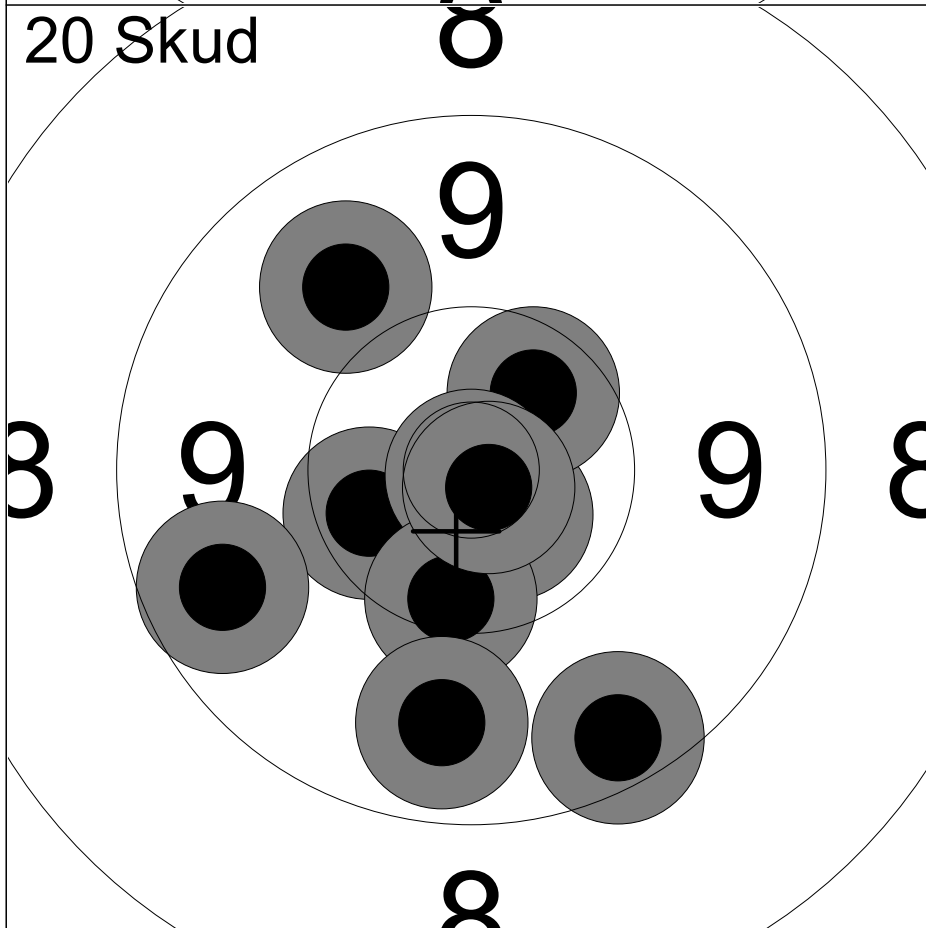

11:	10.7x	↘
12:	10.5x	↗
13:	10.4x	↖
14:	9.6	↖
15:	9.9	↗
16:	10.9x	↘
17:	10.3	↘
18:	9.4	↘
19:	9.7	↘
20:	10.8x	↘
Serie		96 (5x)
Total		194 (9x)

Hold 23	Skive 5	Amanda Jensen	
50M	Frederikssund Skytteforening, I	J2	
10.08.2024	EM 2024	Hanebjerg Skyttecenter	
Kommentar	Signatur		

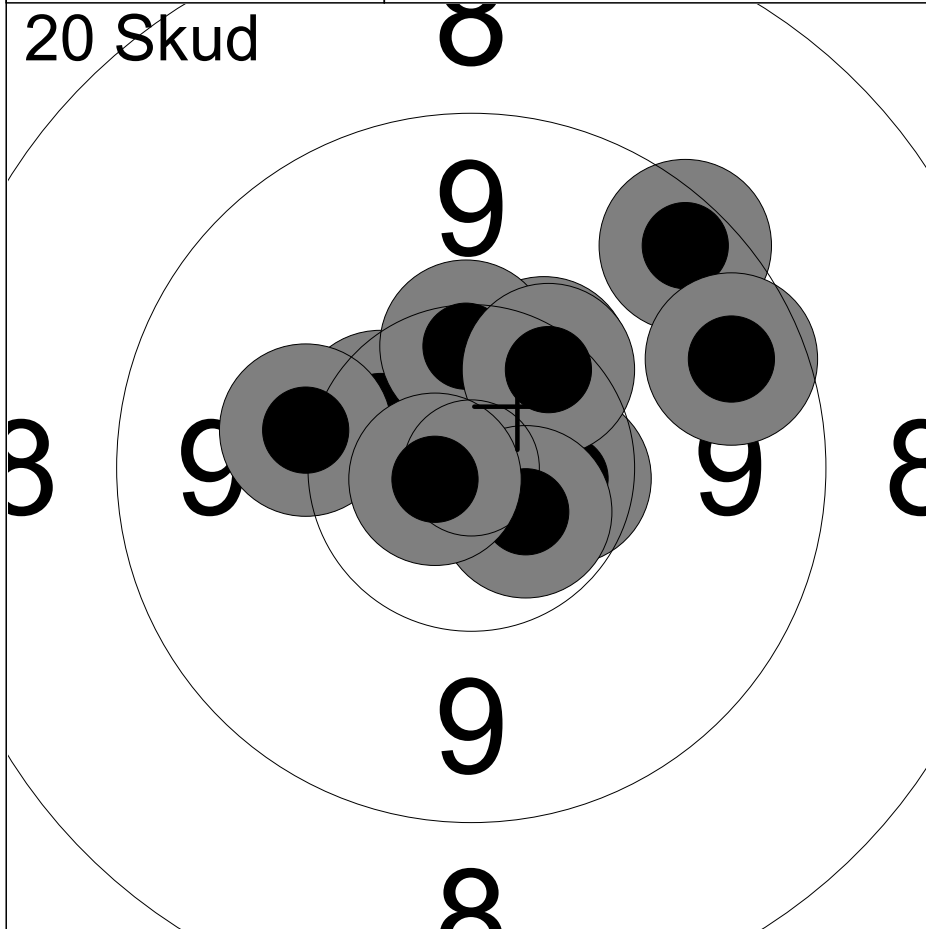

1:	10.5x	→
2:	10.4x	↖
3:	10.3	↗
4:	10.4	↑
5:	9.4	↗
6:	10.3	↗
7:	10.6x	↘
8:	9.6	↗
9:	10.1	←
10:	10.8x	←
Serie		98 (4x)
Total		98 (4x)

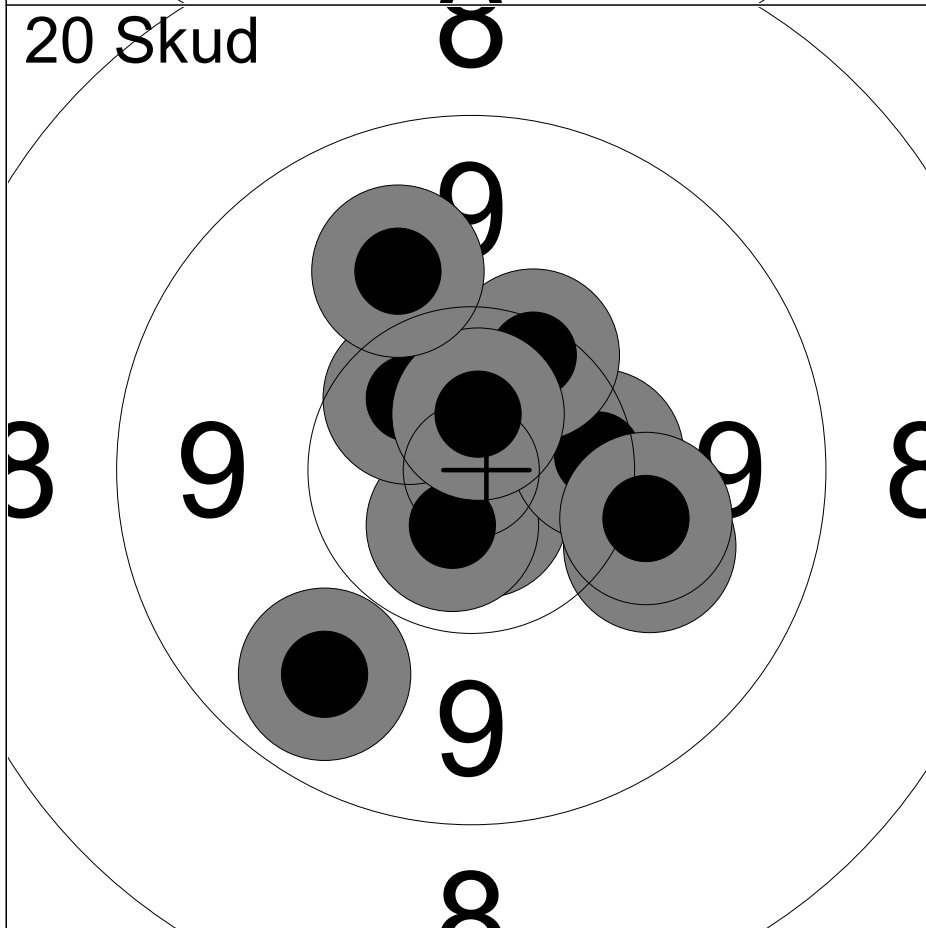

11:	10.7x	↓
12:	10.7x	↓
13:	10.3	→
14:	9.7	↖
15:	10.5x	↗
16:	10.3	↗
17:	10.7x	↑
18:	9.9	↗
19:	10.0	↘
20:	10.1	↘
Serie		98 (4x)
Total		196 (8x)

Hold 23	Skive 6	Simon Jansen	
50M	Ganløse Skytteforening	BK1	
10.08.2024	EM 2024	Hanebjerg Skyttecenter	
Kommentar	Signatur		

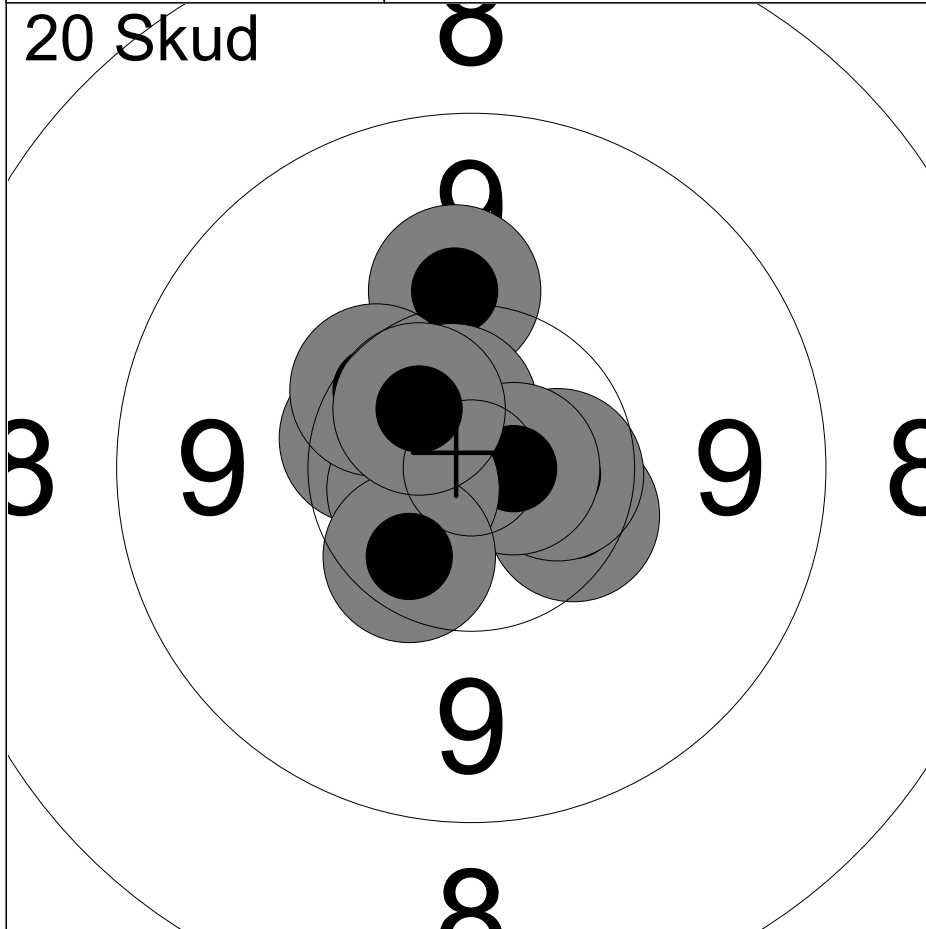

1:	10.1	↗
2:	10.4x	↖
3:	10.7x	↗
4:	10.4	↘
5:	10.5x	→
6:	10.7x	→
7:	10.7x	↖
8:	10.4x	↘
9:	10.4	↗
10:	10.6x	↗
Serie		100 (7x)
Total		100 (7x)

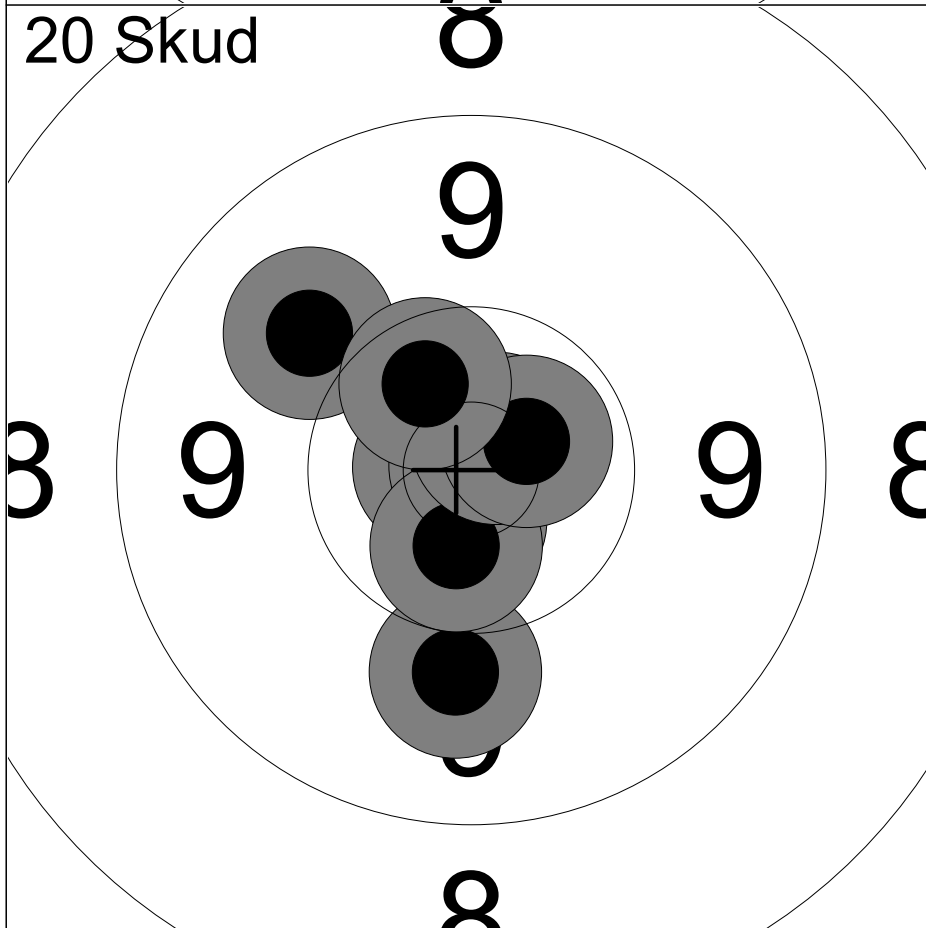

11:	10.7x	↗
12:	10.0	↘
13:	10.7x	↘
14:	10.8x	↖
15:	10.9x	↗
16:	9.9	↗
17:	10.6x	↘
18:	10.8x	↗
19:	10.6x	↗
20:	10.5x	↗
Serie		99 (8x)
Total		199 (15x)

Hold 23	Skive 7	Therkel William Haagemann	
50M	Ganløse Skytteforening	J1	
10.08.2024	EM 2024	Hanebjerg Skyttecenter	
Kommentar	Signatur		

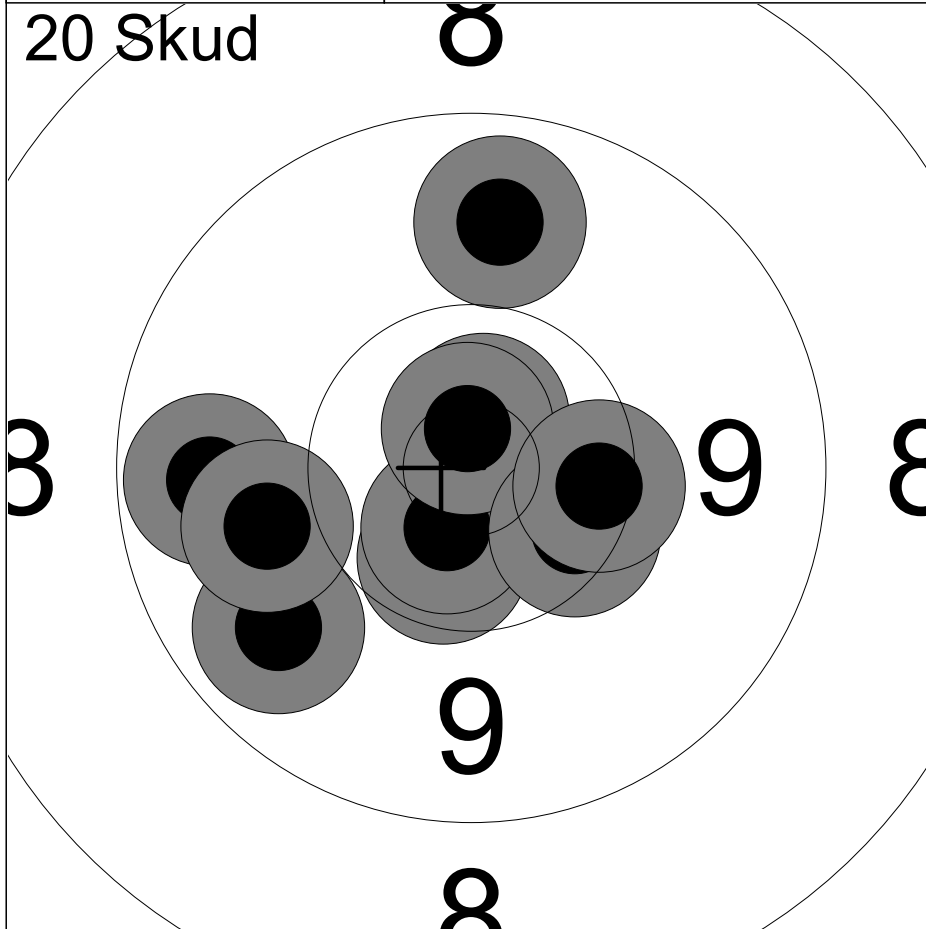

1:	9.7	←
2:	9.7	↙
3:	9.7	↑
4:	10.5x	↘
5:	10.7x	↑
6:	10.6x	↘
7:	10.8x	↑
8:	9.9	←
9:	10.4	↘
10:	10.3	→
Serie		96 (4x)
Total		96 (4x)

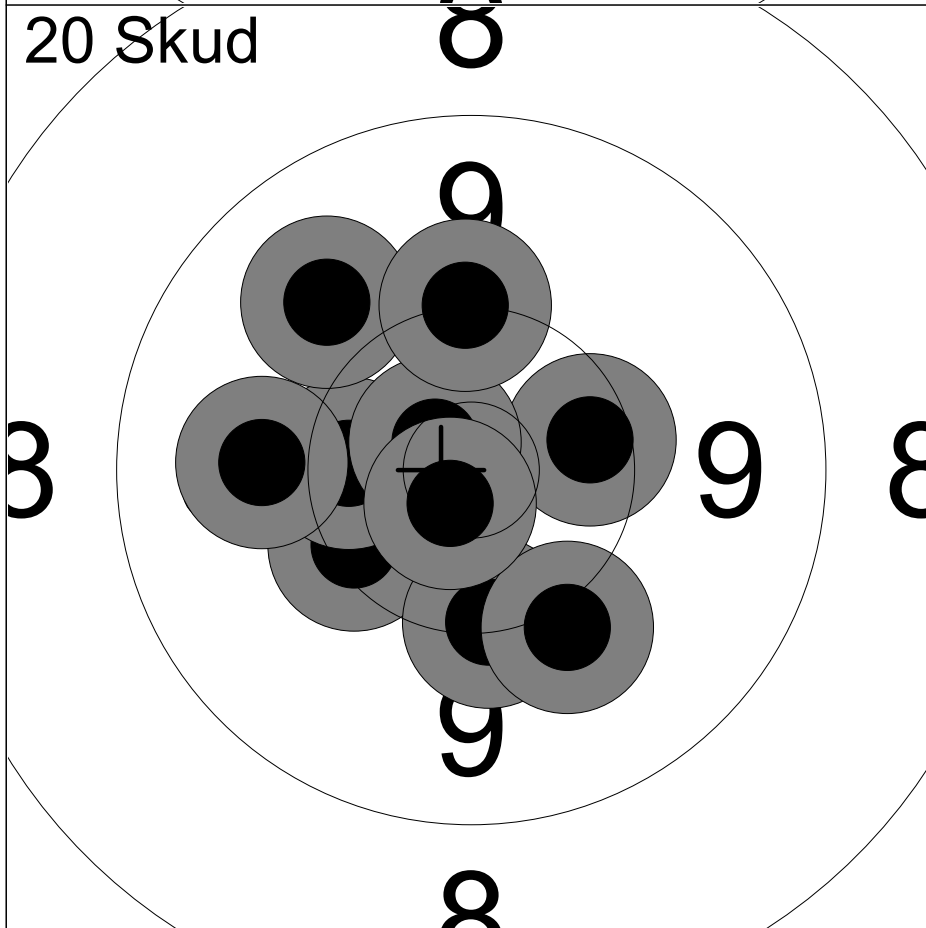

11:	10.3	↙
12:	10.4	←
13:	10.2	↘
14:	10.1	↘
15:	10.4	→
16:	10.7x	↗
17:	9.9	↗
18:	9.9	←
19:	10.2	↑
20:	10.8x	↘
Serie		98 (2x)
Total		194 (6x)

Hold 23	Skive 8	Marcus Elleroed Hansen	
50M	Ganløse Skytteforening	J2	
10.08.2024	EM 2024	Hanebjerg Skyttecenter	
Kommentar	Signatur		

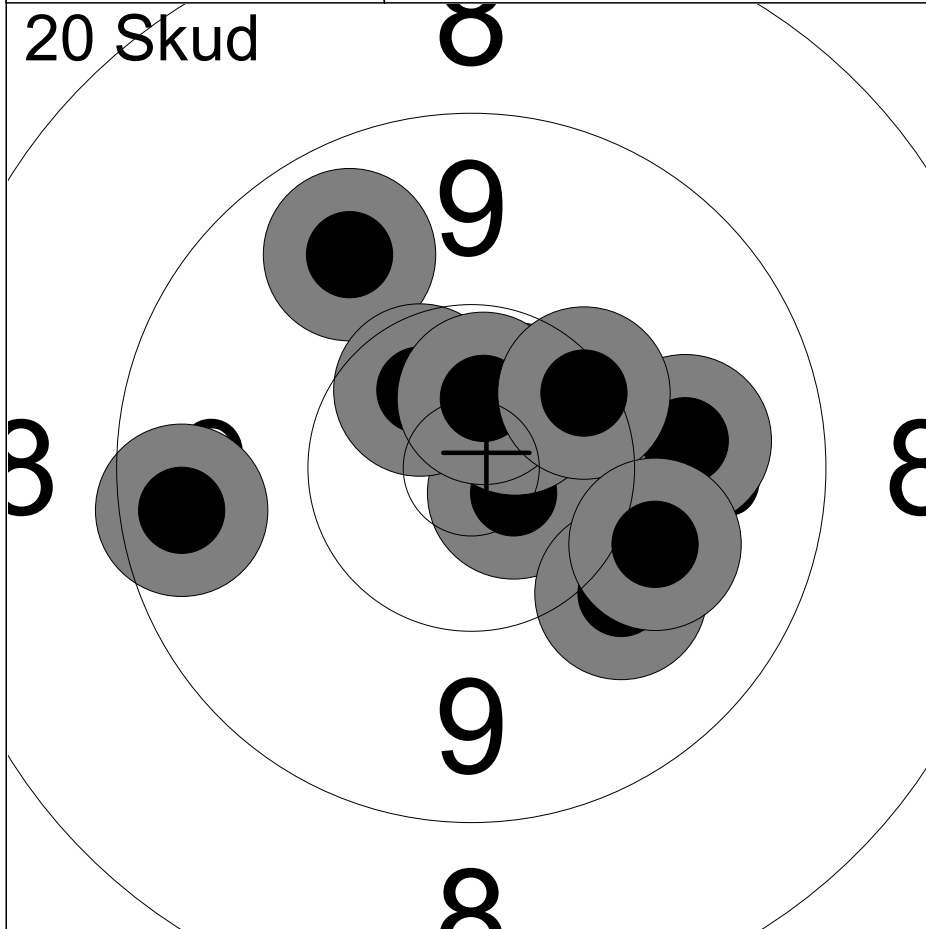

1:	10.7x	↘
2:	9.7	↗
3:	9.5	←
4:	10.6x	↗
5:	10.5x	↗
6:	10.0	↘
7:	9.9	→
8:	10.6x	↗
9:	10.3	↗
10:	10.0	↘
Serie		97 (4x)
Total		97 (4x)

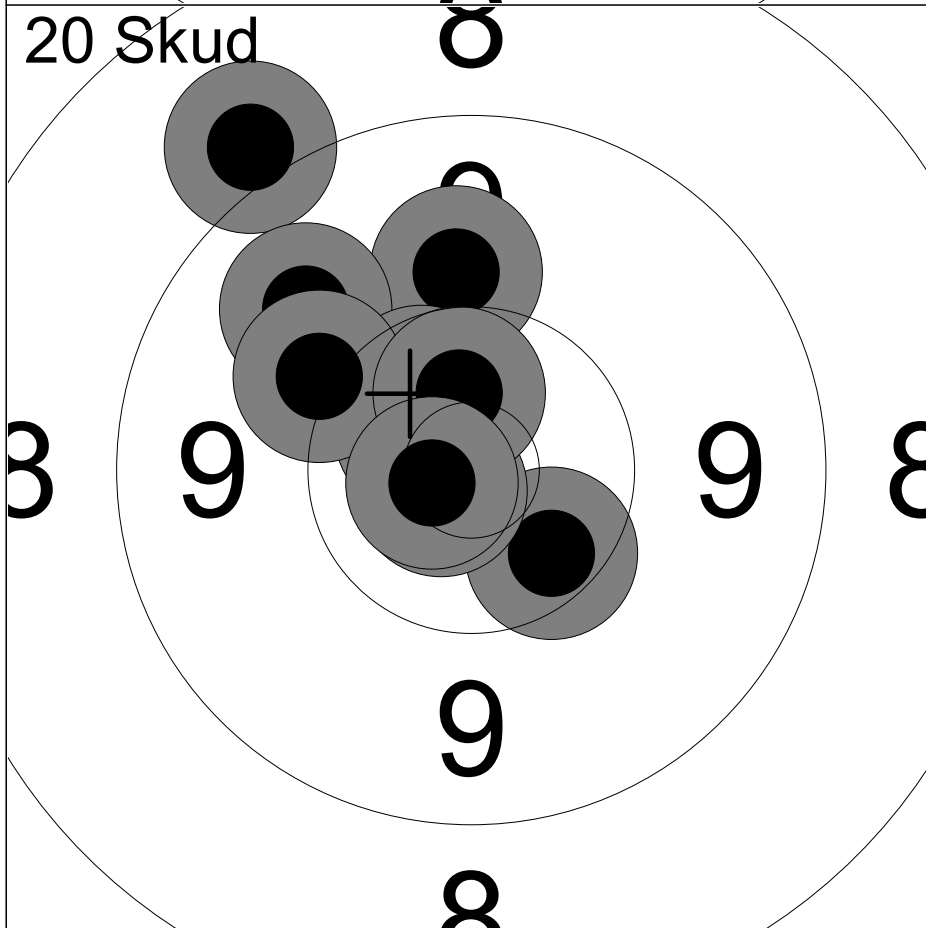

11:	9.0	↗
12:	10.0	↗
13:	10.6x	↗
14:	9.8	↗
15:	10.4	↘
16:	10.8x	←
17:	10.5x	↗
18:	10.1	↗
19:	10.6x	↗
20:	10.7x	←
Serie		98 (5x)
Total		195 (9x)

Hold 23	Skive 9	Jens Bengtson	
50M	Melby Skytteforening	SE1	
10.08.2024	EM 2024	Hanebjerg Skyttecenter	
Kommentar	Signatur		

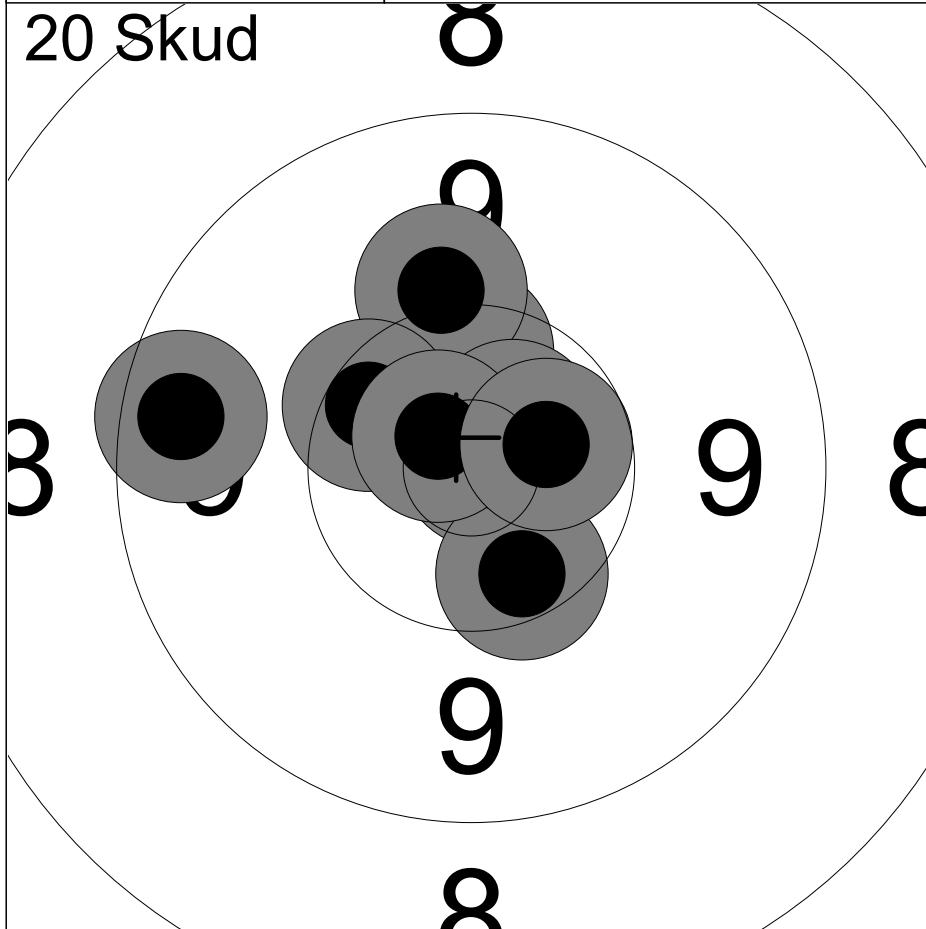

1:	10.4	↑
2:	10.8x	↗
3:	10.1	↑
4:	10.9x	↗
5:	10.4	↘
6:	9.5	←
7:	10.7x	↗
8:	10.4	↖
9:	10.7x	↖
10:	10.6x	↗
Serie		99 (5x)
Total		99 (5x)

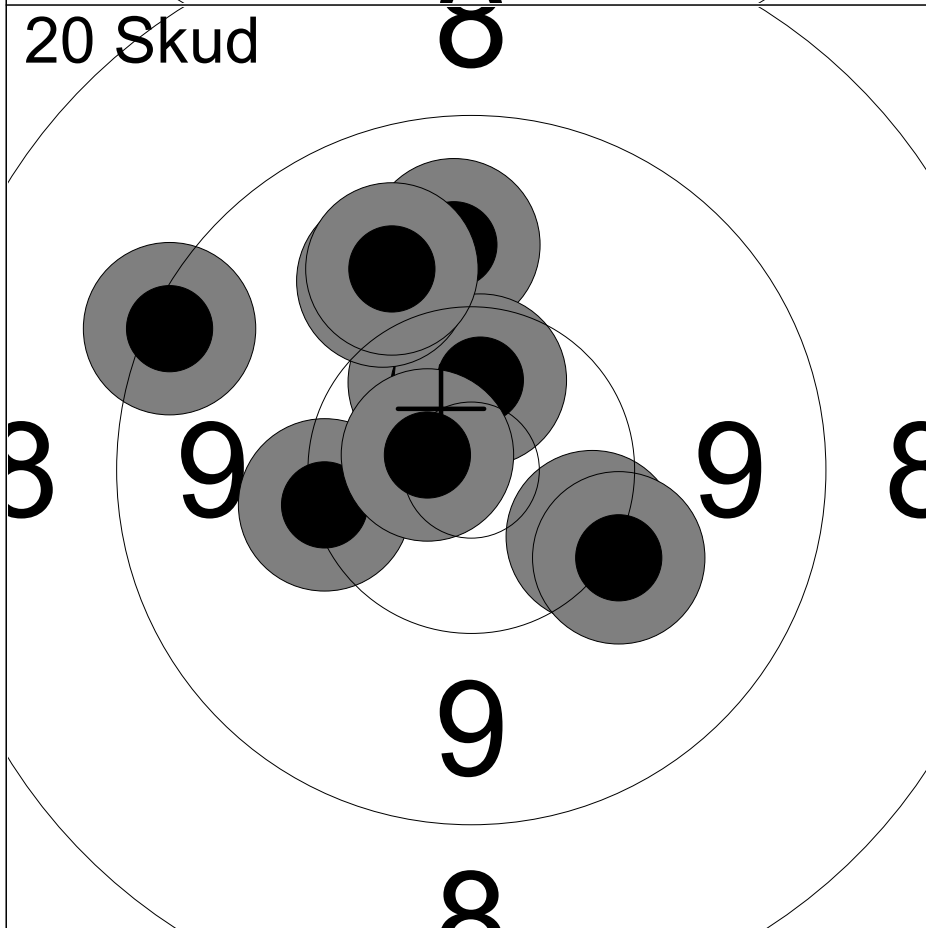

11:	10.5x	↑
12:	9.3	↖
13:	9.8	↑
14:	10.5x	↑
15:	9.9	↖
16:	9.9	↖
17:	10.2	←
18:	10.3	↘
19:	10.1	↘
20:	10.7x	↖
Serie		96 (3x)
Total		195 (8x)

Hold 23	Skive 10	Malou Schmidt-Larsen	
50M		Ølstykke Skytteforening	J2
10.08.2024		EM 2024	Hanebjerg Skyttecenter
Kommentar		Signatur	

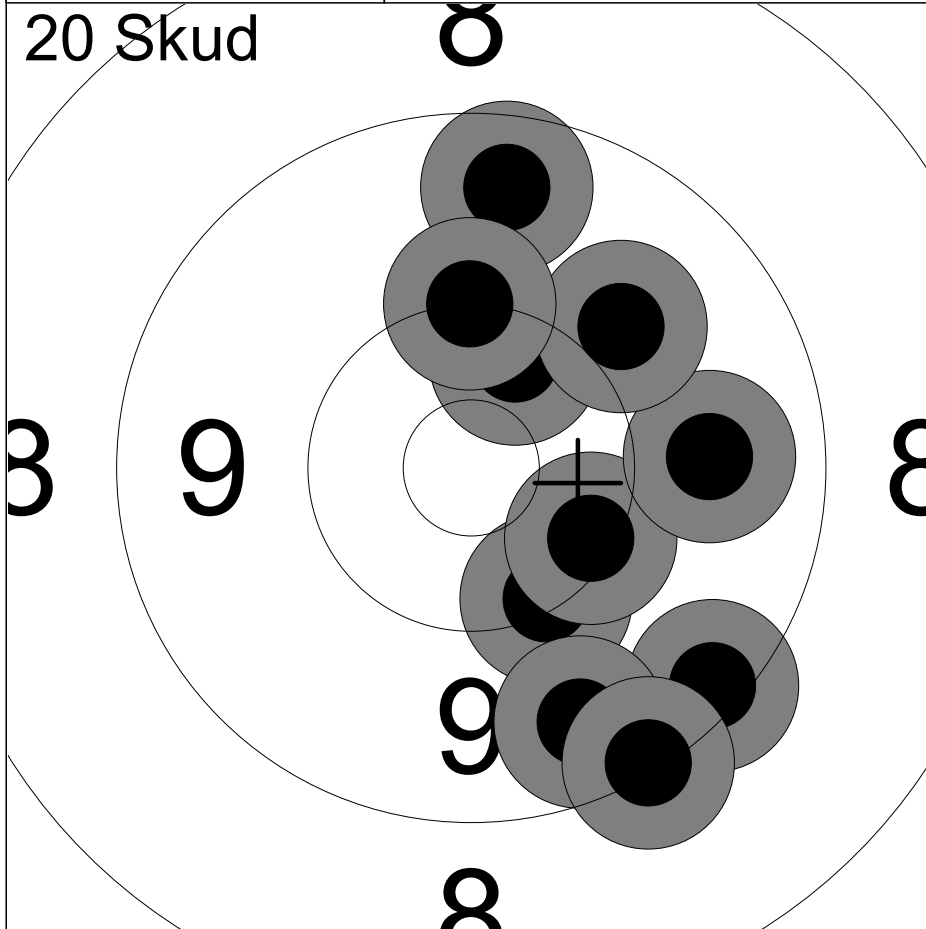

1:	10.2	↘
2:	10.4	↗
3:	9.3	↘
4:	9.6	↘
5:	9.2	↘
6:	10.3	↘
7:	9.8	→
8:	10.0	↗
9:	9.6	↑
10:	10.2	↑
Serie		95 (0x)
Total		95 (0x)

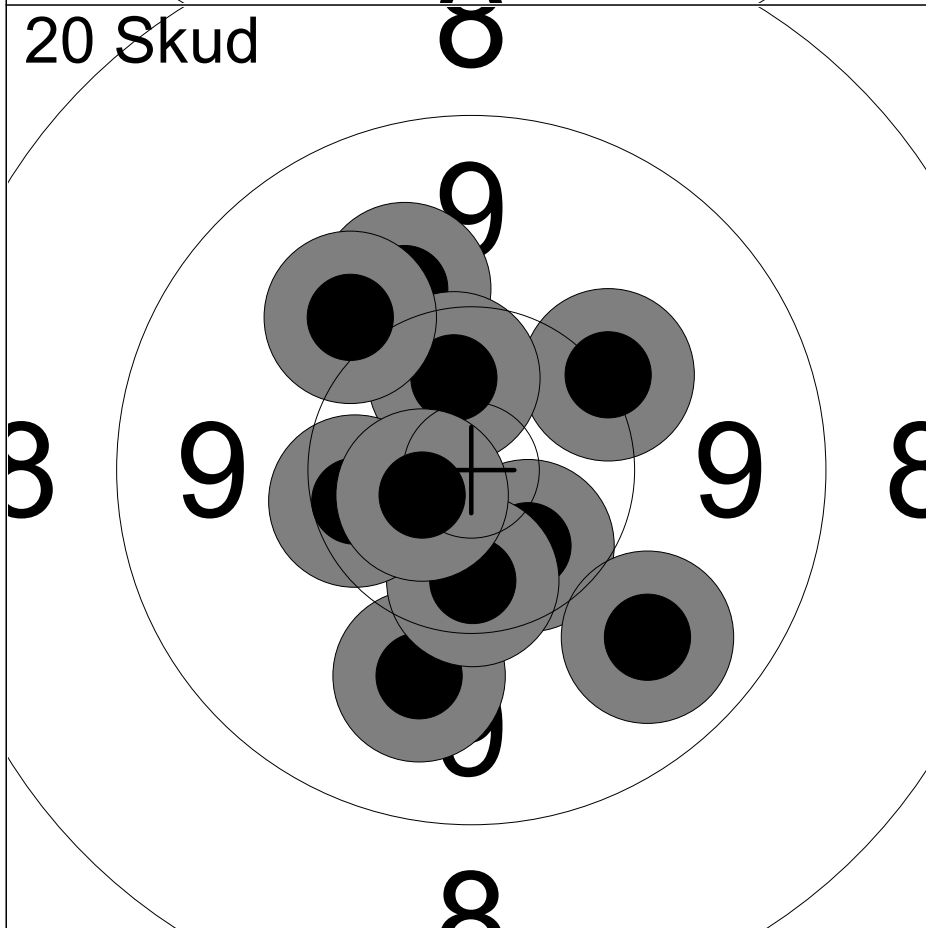

11:	10.5x	↘
12:	9.8	↘
13:	10.1	↗
14:	10.0	↗
15:	10.5x	↗
16:	9.9	↘
17:	10.0	↗
18:	10.4x	↘
19:	10.4	↙
20:	10.7x	↙
Serie		98 (4x)
Total		193 (4x)

Hold 23	Skive 12	Jeannette Frost	
50M		Skyttelaugget Kgs. Lyngby	ST2
10.08.2024		EM 2024	Hanebjerg Skyttecenter
Kommentar		Signatur	

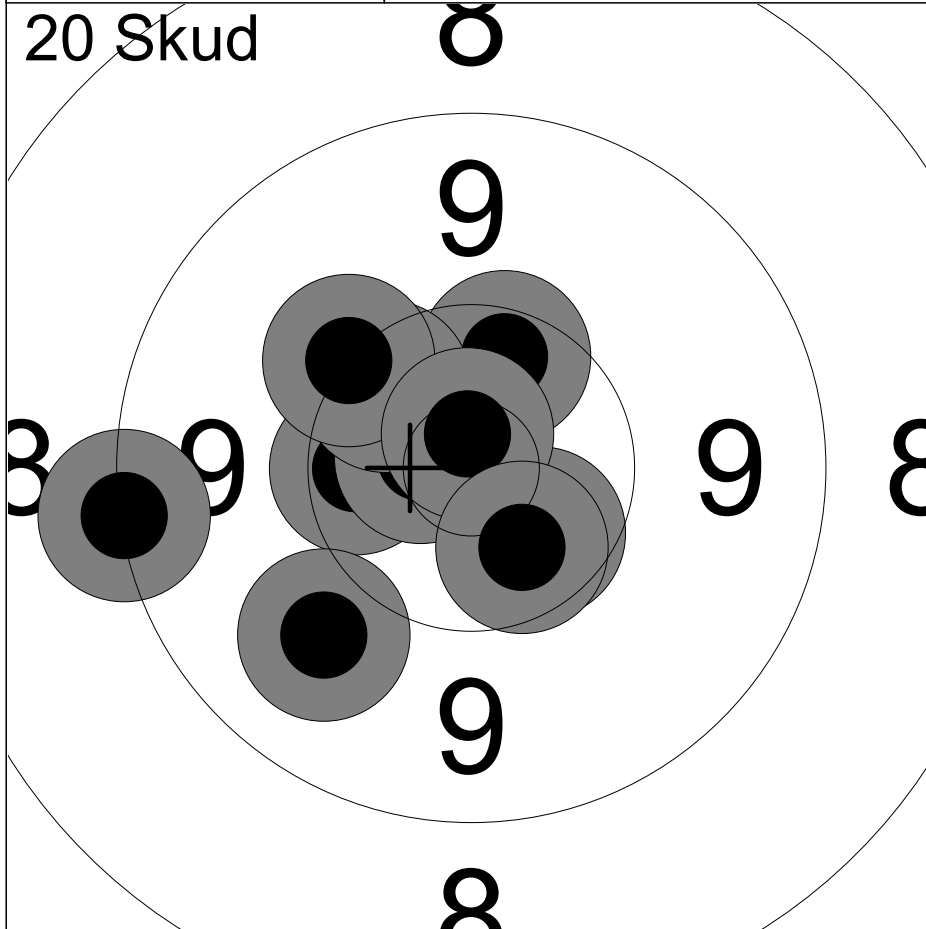

1:	10.4	↗
2:	10.4	←
3:	9.2	←
4:	10.5x	↘
5:	9.9	↘
6:	10.7x	←
7:	10.4	↗
8:	10.2	↗
9:	10.8x	↗
10:	10.5x	↘
Serie		98 (4x)
Total		98 (4x)

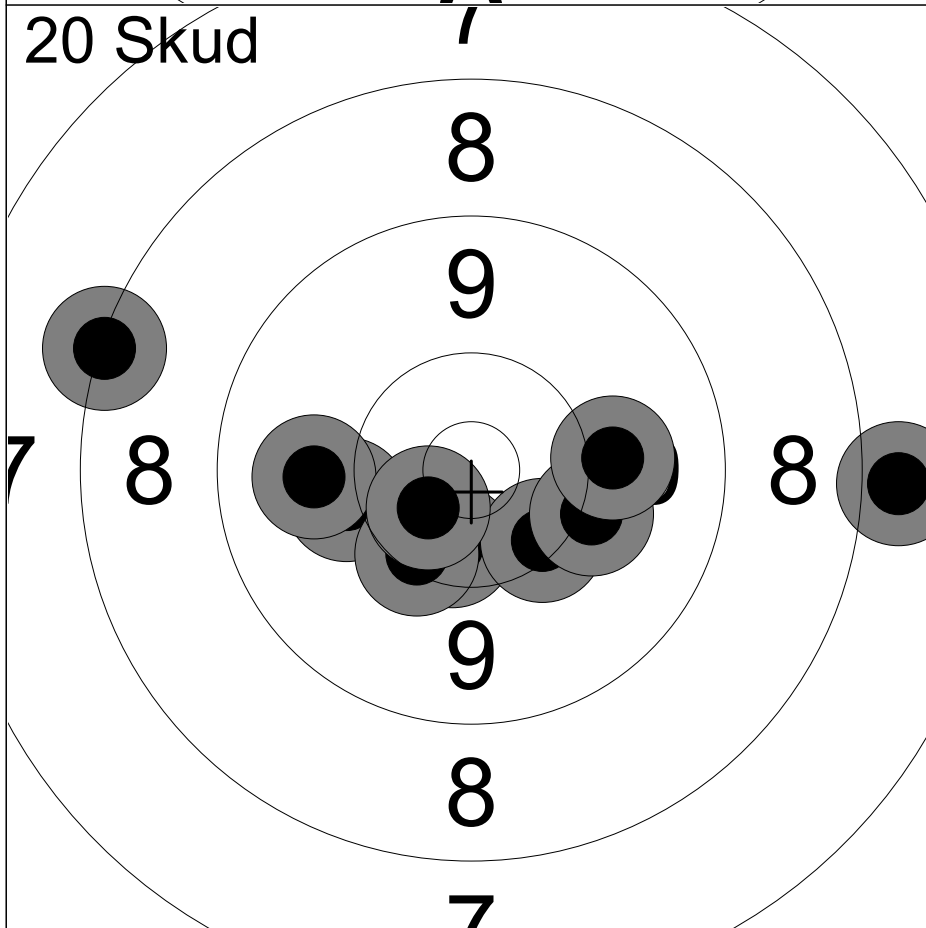

11:	10.4x	↘
12:	10.1	←
13:	10.3	↘
14:	9.9	←
15:	10.3	↘
16:	7.9	→
17:	8.2	←
18:	10.1	↘
19:	10.6x	↘
20:	10.0	→
Serie		94 (2x)
Total		192 (6x)

Hold 24	Skive 1	Noah Misfeldt Kvist-Andersen	
50M	Ganløse Skytteforening	BK1	
10.08.2024	EM 2024	Hanebjerg Skyttecenter	
Kommentar	Signatur		

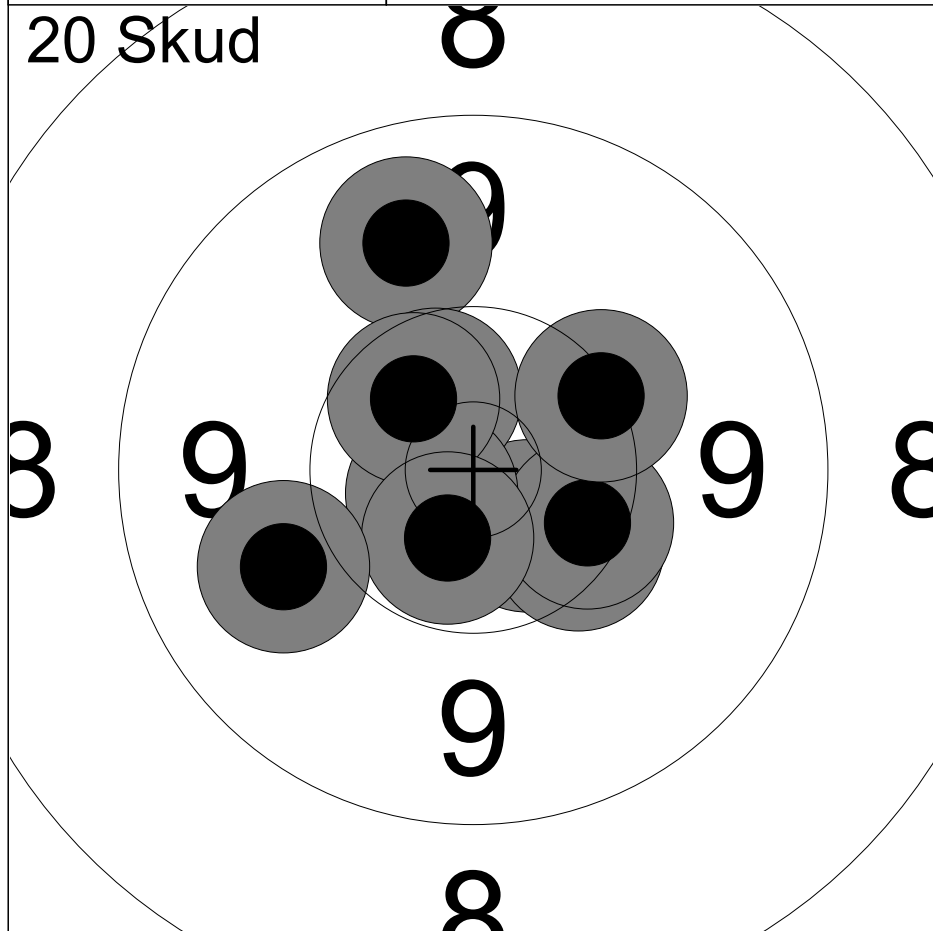

1:	10.6x	↘
2:	10.3	↘
3:	10.3	↘
4:	9.8	↗
5:	10.5x	↗
6:	10.7x	↙
7:	10.5x	↗
8:	10.2	↗
9:	10.6x	↘
10:	9.9	↙
Serie		98 (5x)
Total		98 (5x)

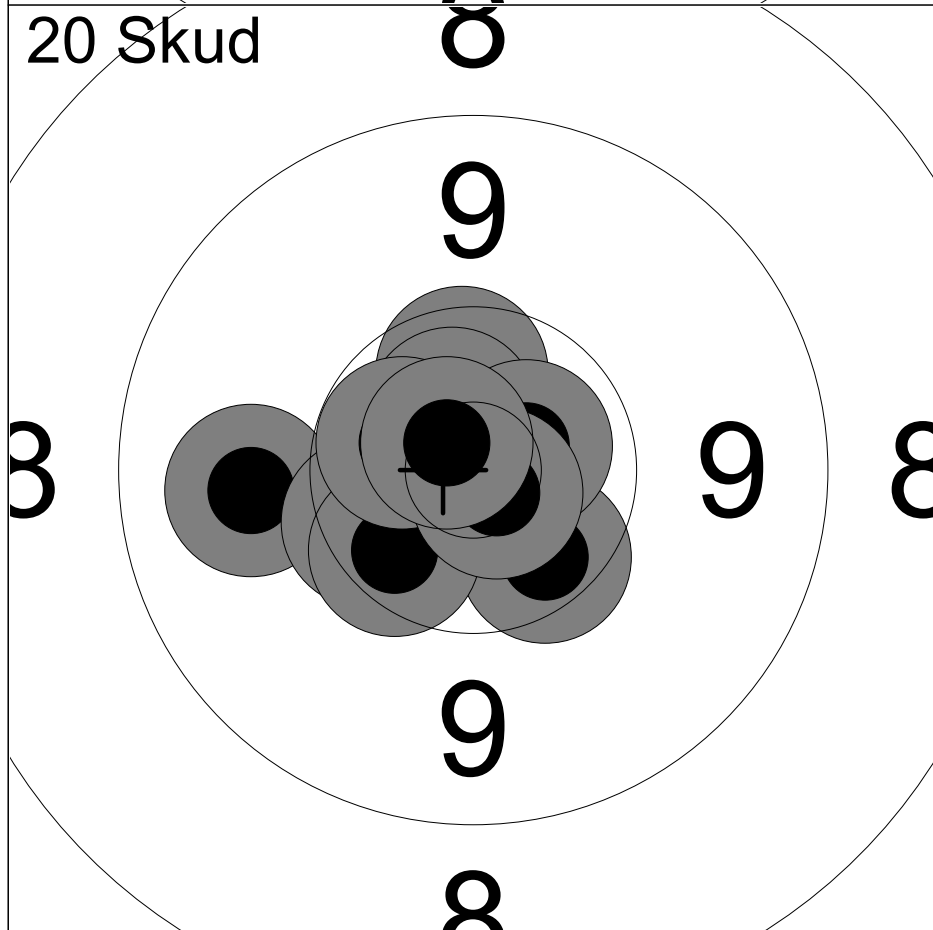

11:	10.5x	↗
12:	9.9	↙
13:	10.4	↙
14:	10.7x	↗
15:	10.4	↘
16:	10.4	↙
17:	10.7x	↗
18:	10.6x	↗
19:	10.8x	↘
20:	10.8x	↗
Serie		99 (6x)
Total		197 (11x)

Hold 24	Skive 2	Viktor Lund-Vogensen	
50M	Ganløse Skytteforening	BK1	
10.08.2024	EM 2024	Hanebjerg Skyttecenter	
Kommentar	Signatur		



1:	10.4	↘
2:	10.3	↖
3:	10.3	↗
4:	10.4x	↖
5:	10.7x	→
6:	10.3	↘
7:	10.6x	↘
8:	10.9x	↖
9:	10.7x	↘
10:	10.5x	↗
Serie		100 (6x)
Total		100 (6x)

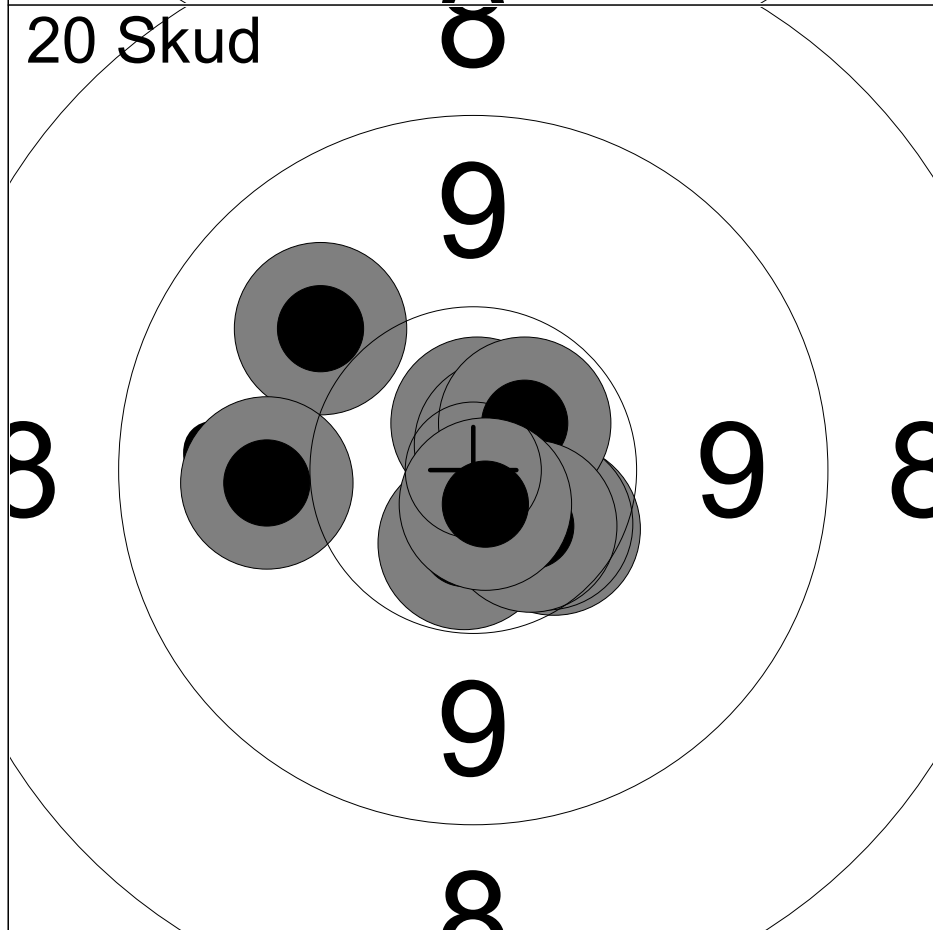

11:	10.7x	↗
12:	10.8x	↗
13:	10.6x	↘
14:	10.5x	↘
15:	10.5x	↘
16:	9.9	↖
17:	10.6x	↗
18:	10.6x	↘
19:	10.8x	↘
20:	9.9	↖
Serie		98 (8x)
Total		198 (14x)

Hold 24	Skive 3	Emil Lund-Vogensen	
50M	Ganløse Skytteforening	J1	
10.08.2024	EM 2024	Hanebjerg Skyttecenter	
Kommentar	Signatur		

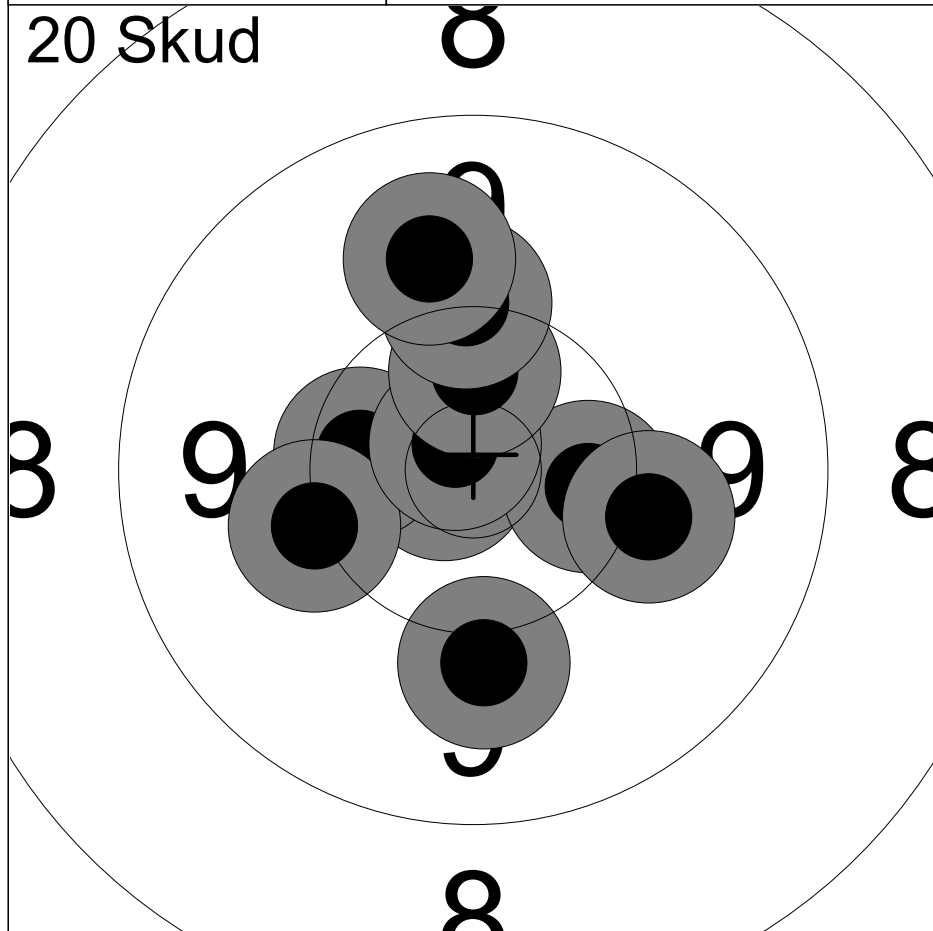

1:	10.8x	←
2:	10.4	←
3:	10.1	←
4:	10.4	→
5:	10.0	↓
6:	10.8x	↖
7:	10.5x	↑
8:	10.1	↑
9:	9.9	↑
10:	10.1	→

Serie	99 (3x)
Total	99 (3x)



11:	10.6x	←
12:	10.9x	↙
13:	9.9	↙
14:	10.6x	→
15:	9.9	↓
16:	10.8x	↓
17:	10.6x	↗
18:	10.6x	↙
19:	10.4x	↙
20:	10.6x	↑

Serie	98 (8x)
Total	197 (11x)

Hold 24	Skive 4	Frederik Lund-Vogensen	
50M	Ganløse Skytteforening	BK1	
10.08.2024	EM 2024	Hanebjerg Skyttecenter	
Kommentar	Signatur		

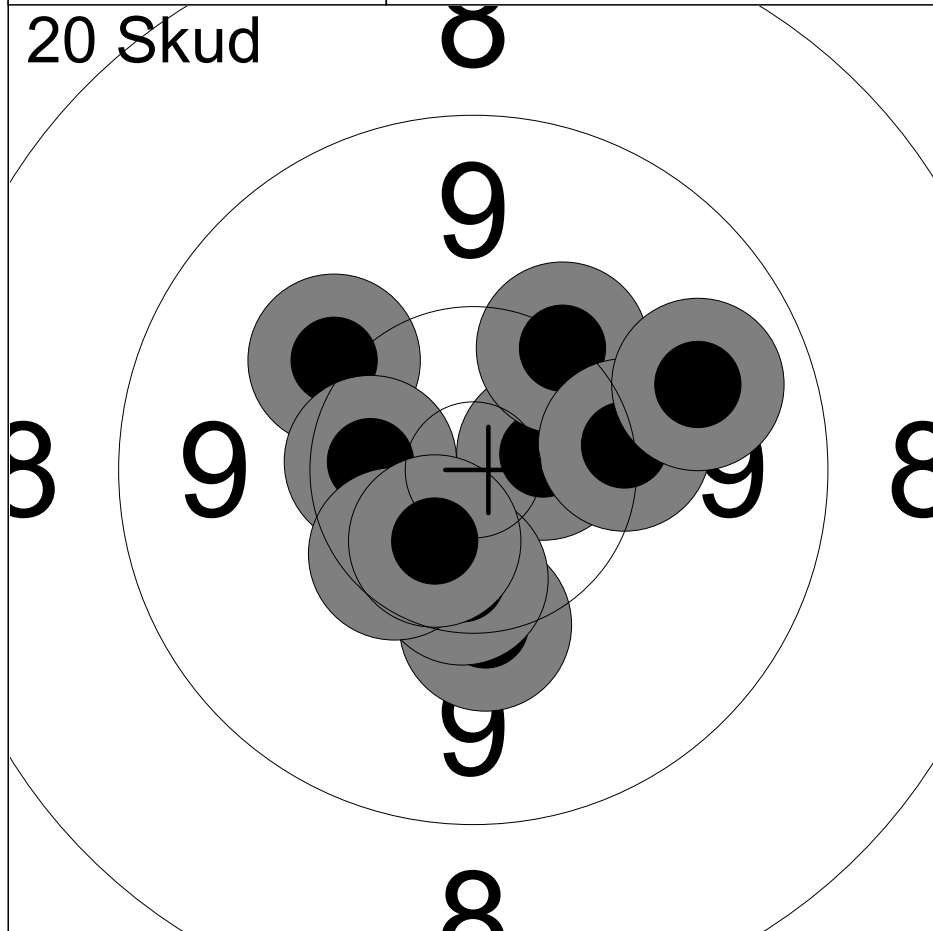

1:	10.6x	→
2:	10.2	↓
3:	10.2	↗
4:	10.2	→
5:	10.1	↖
6:	10.4x	↓
7:	10.5x	←
8:	10.4	↙
9:	9.8	→
10:	10.6x	↘
Serie		99 (4x)
Total		99 (4x)

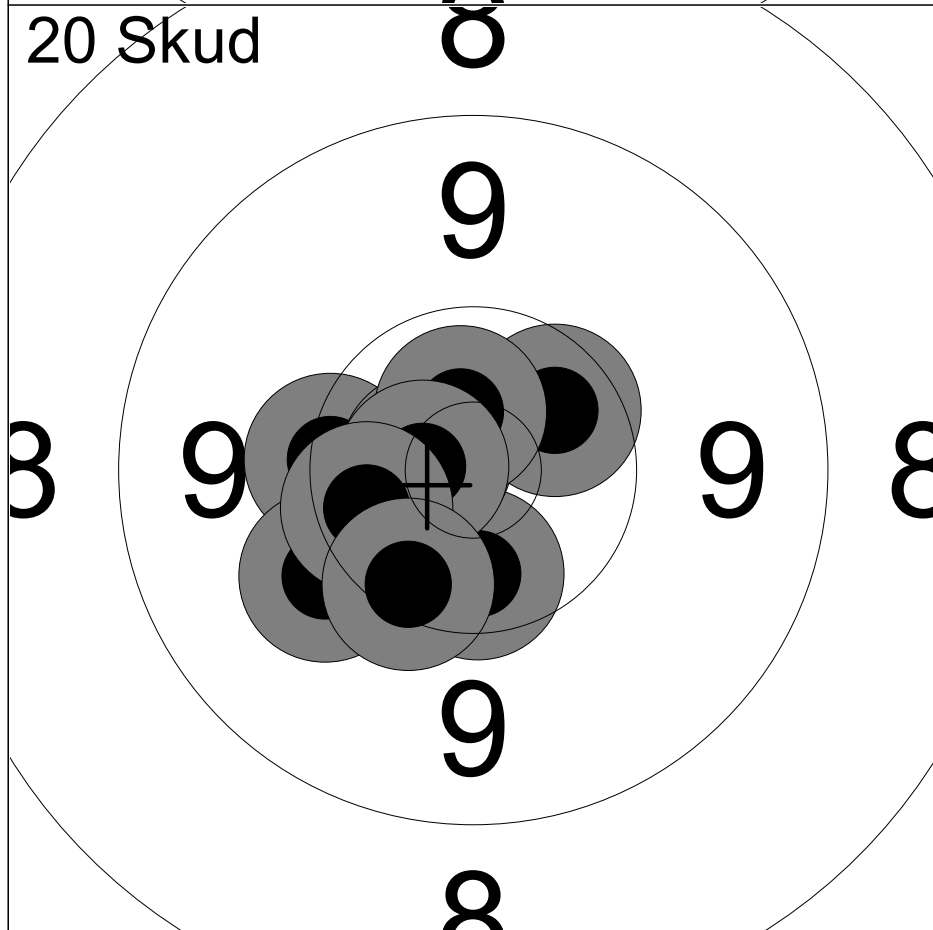

11:	10.4x	↓
12:	10.5x	↗
13:	10.6x	←
14:	10.3	←
15:	10.1	↙
16:	10.7x	←
17:	10.7x	↖
18:	10.7x	←
19:	10.4	←
20:	10.3	↘
Serie		100 (6x)
Total		199 (10x)

Hold 24	Skive 6	William Moelbak		
50M	Frederikssund Skytteforening, I		MBK1	
10.08.2024	EM 2024	Hanebjerg Skyttecenter		
Kommentar	Signatur			

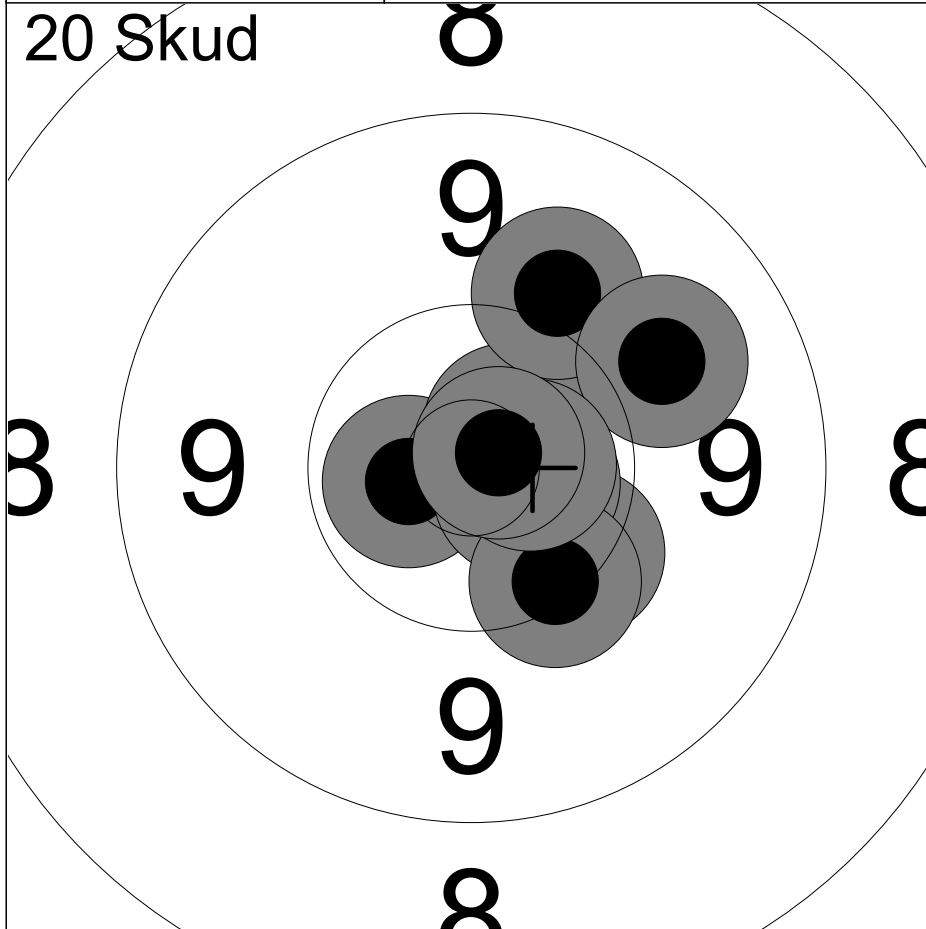

1:	10.6x	←
2:	10.7x	↗
3:	10.3	↘
4:	10.0	↗
5:	10.6x	→
6:	10.7x	↘
7:	9.9	↗
8:	10.3	↘
9:	10.7x	→
10:	10.8x	↗
Serie		99 (6x)
Total		99 (6x)

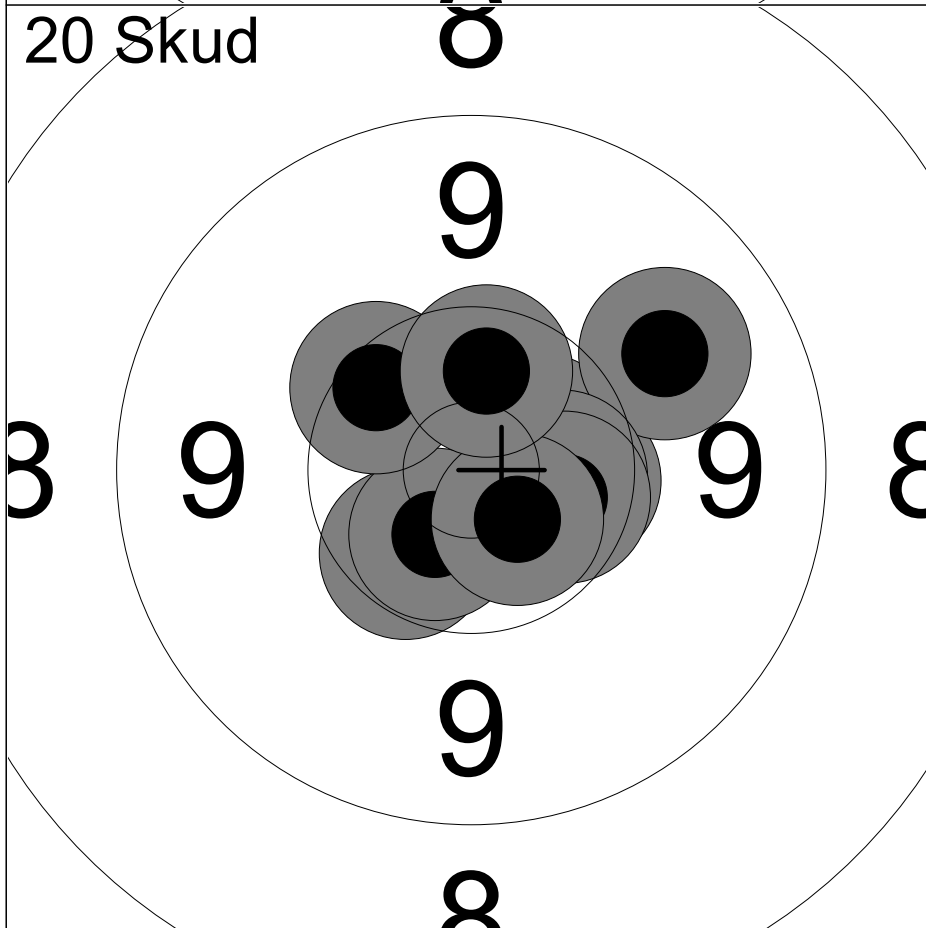

11:	10.4x	→
12:	10.6x	↗
13:	9.8	↗
14:	10.5x	→
15:	10.4x	↘
16:	10.6x	↘
17:	10.3	↗
18:	10.5x	↘
19:	10.6x	↘
20:	10.5x	↗
Serie		99 (8x)
Total		198 (14x)

Hold 24	Skive 7	Sebastian Ebert Soerensen	
50M	Frederikssund Skytteforening, I	J1	
10.08.2024	EM 2024	Hanebjerg Skyttecenter	
Kommentar	Signatur		

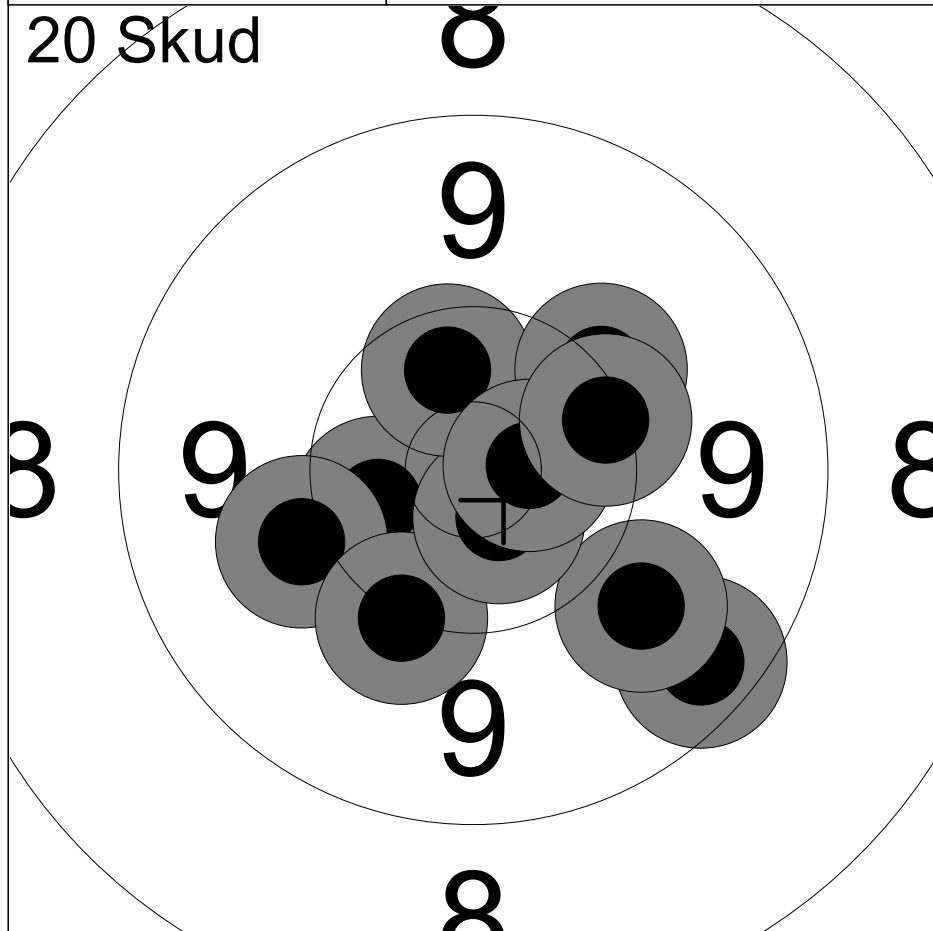

1:	9.5	↘
2:	10.5x	↙
3:	10.0	↙
4:	10.2	↘
5:	9.9	↘
6:	10.7x	↘
7:	10.4x	↗
8:	10.2	↗
9:	10.7x	→
10:	10.3	↗
Serie		98 (4x)
Total		98 (4x)

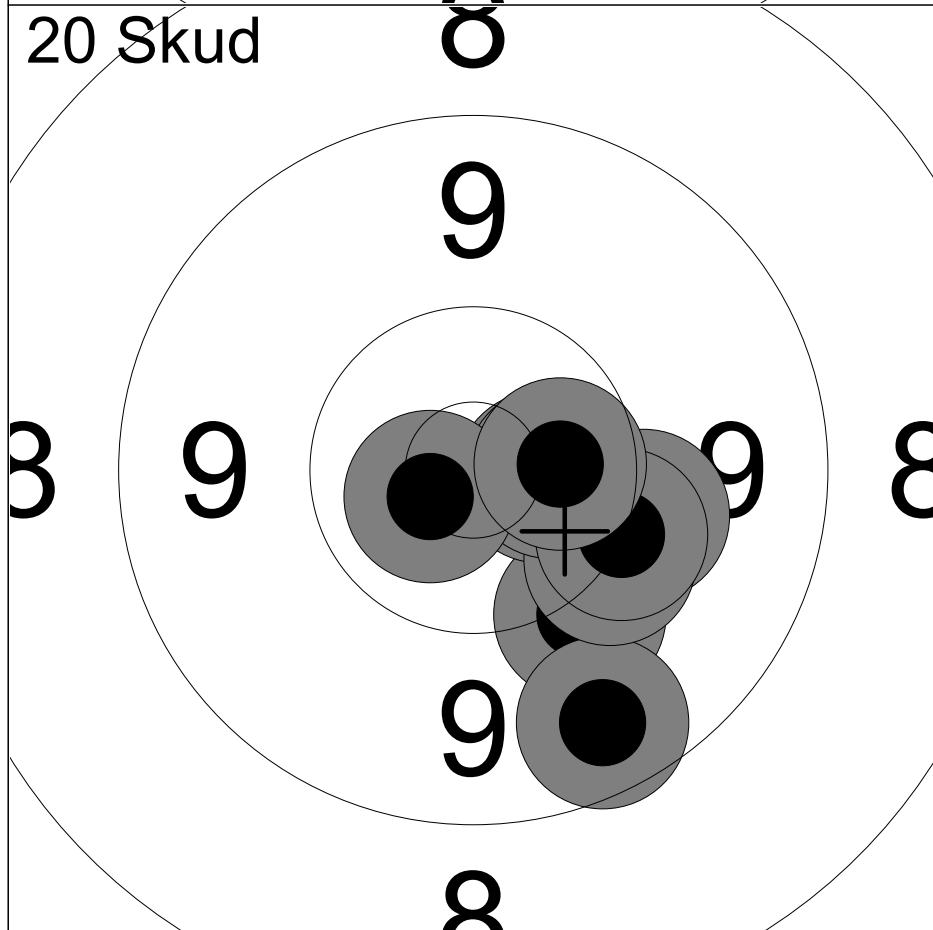

11:	10.5x	→
12:	10.1	↘
13:	9.5	↘
14:	10.6x	→
15:	10.1	↘
16:	10.2	↘
17:	10.6x	→
18:	10.2	↘
19:	10.7x	↙
20:	10.5x	→
Serie		99 (5x)
Total		197 (9x)

Hold 24	Skive 8	Cecilie Bugge Deichmann	
50M	Ølstykke Skytteforening	J1	
10.08.2024	EM 2024	Hanebjerg Skyttecenter	
Kommentar	Signatur		



1:	10.4x	←
2:	10.2	↘
3:	10.5x	↘
4:	10.5x	←
5:	10.8x	↑
6:	10.7x	↘
7:	10.8x	↗
8:	10.7x	←
9:	10.5x	↘
10:	10.7x	←
Serie		100 (9x)
Total		100 (9x)

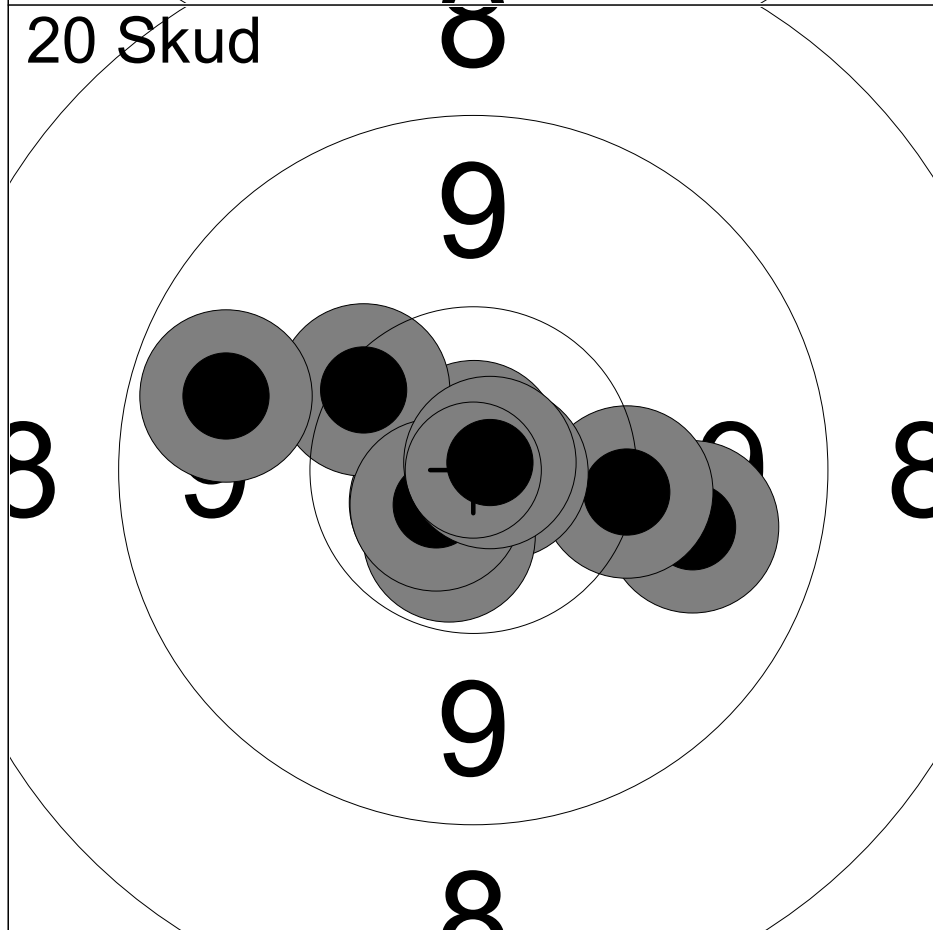

11:	9.8	→
12:	10.2	→
13:	10.7x	↙
14:	10.8x	↑
15:	10.8x	→
16:	10.3	↗
17:	9.7	←
18:	10.6x	↘
19:	10.7x	↙
20:	10.9x	↗
Serie		98 (6x)
Total		198 (15x)

Hold 24	Skive 9	Jens Bengtson		
50M		Melby Skytteforening	MSE1	
10.08.2024		EM 2024	Hanebjerg Skyttecenter	
Kommentar		Signatur		

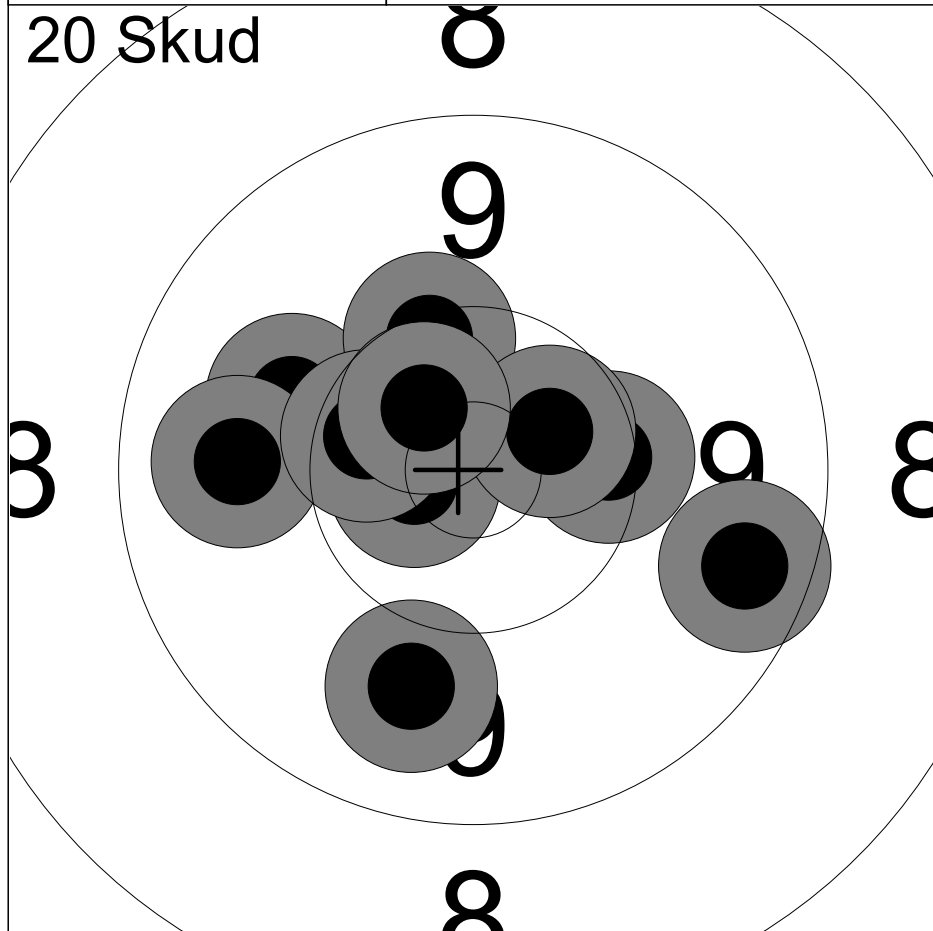

1:	10.0	↖
2:	10.7x	←
3:	10.3	↑
4:	10.3	→
5:	10.5x	↗
6:	9.5	↘
7:	9.8	←
8:	9.9	↓
9:	10.4	↖
10:	10.6x	↗
Serie		97 (3x)
Total		97 (3x)

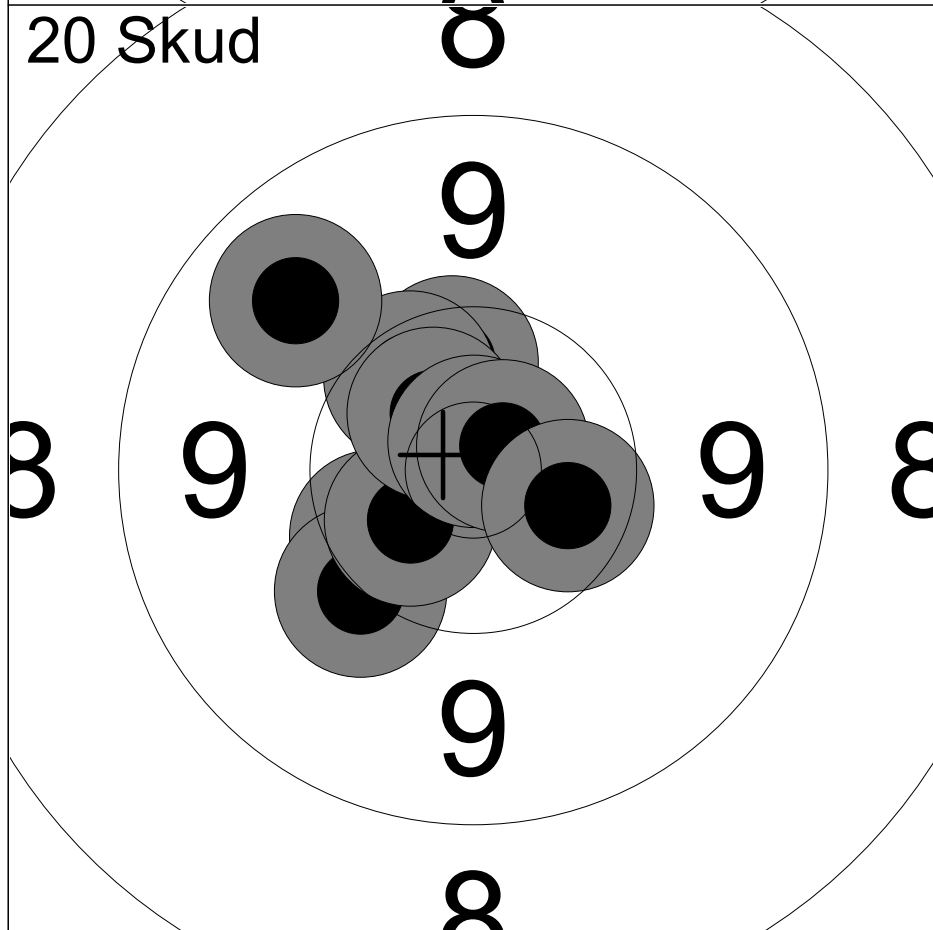

11:	10.4x	↑
12:	10.4	↖
13:	10.1	↖
14:	10.4	↗
15:	10.6x	↖
16:	10.6x	↗
17:	10.8x	↑
18:	10.8x	↗
19:	10.5x	↘
20:	9.7	↖
Serie		99 (6x)
Total		196 (9x)

Hold 24	Skive 11	Mikkel Kannik	
50M		Ølstykke Skytteforening	MST2
10.08.2024		EM 2024	Hanebjerg Skyttecenter
Kommentar		Signatur	

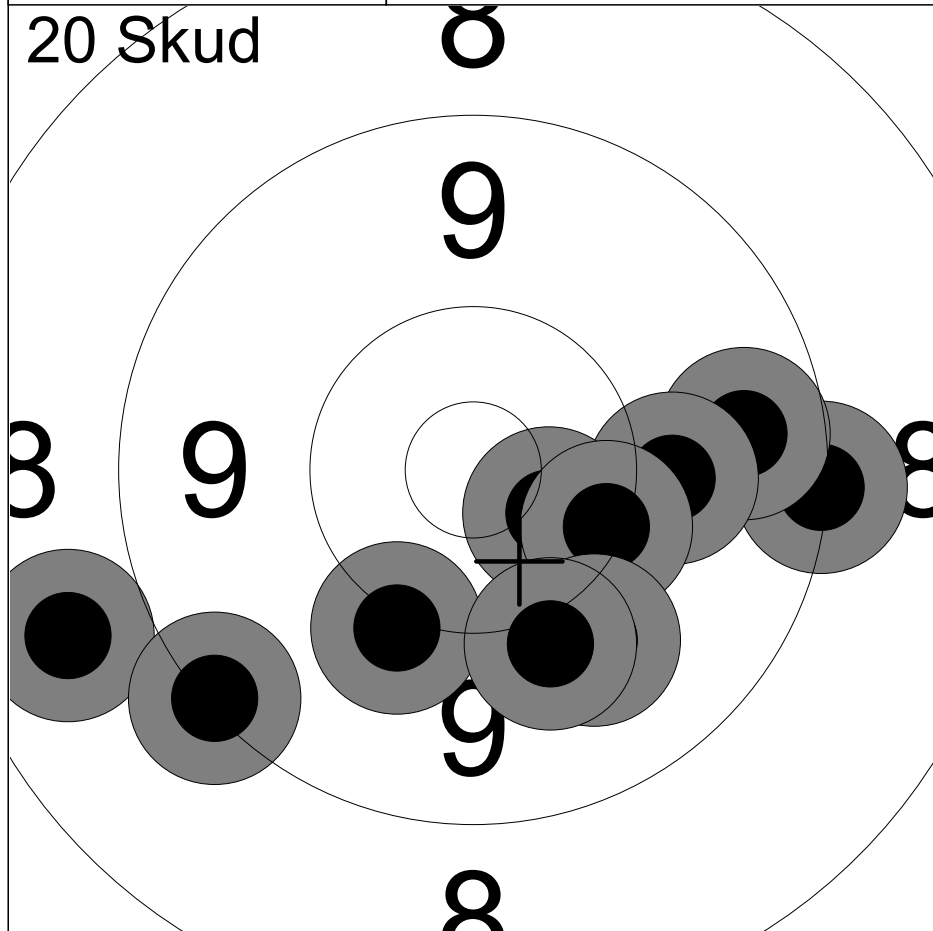

1:	9.2	→
2:	10.1	↙
3:	9.6	→
4:	10.0	→
5:	10.5x	↘
6:	8.7	←
7:	9.2	↙
8:	10.3	→
9:	9.9	↘
10:	10.0	↘

Serie	94 (1x)
Total	94 (1x)

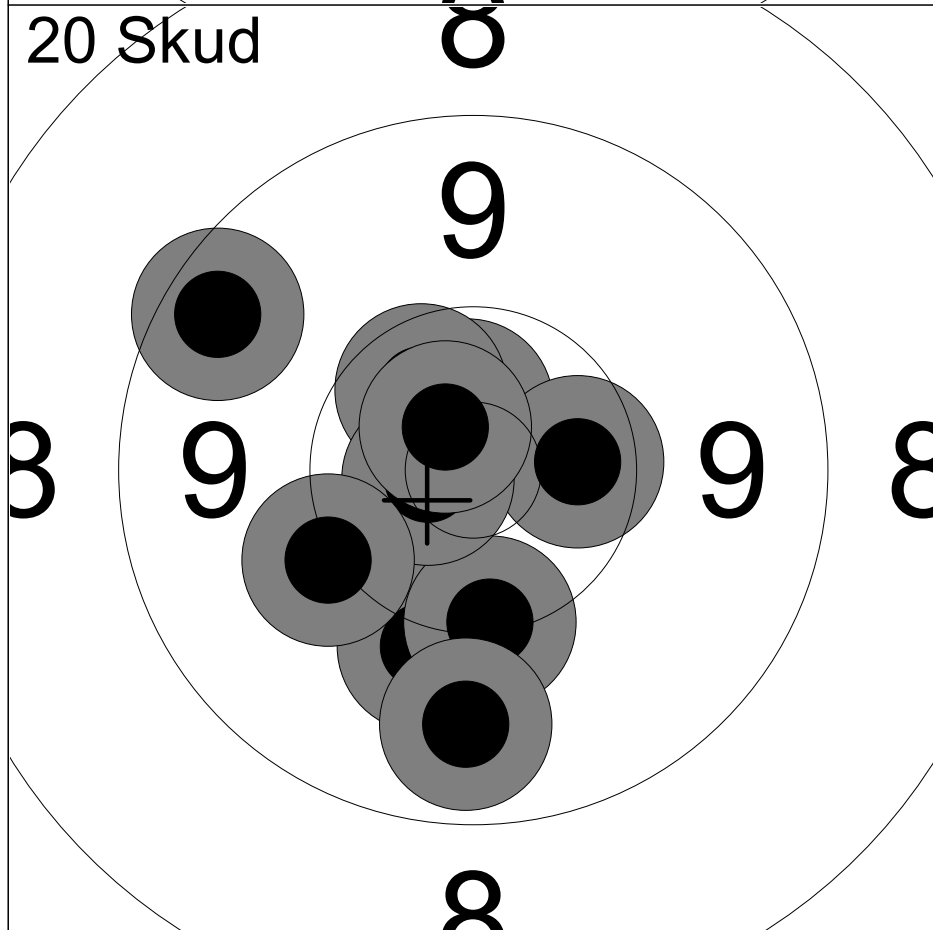

11:	10.1	↙
12:	10.6x	↑
13:	10.4x	→
14:	10.2	↘
15:	10.5x	↗
16:	9.5	↖
17:	10.7x	←
18:	9.7	↘
19:	10.7x	↗
20:	10.1	↙

Serie	98 (5x)
Total	192 (6x)

Hold 24	Skive 12	Thomas Pedersen	
50M	Jørlunde Skytteforening	ST3	
10.08.2024	EM 2024	Hanebjerg Skyttecenter	
Kommentar	Signatur		

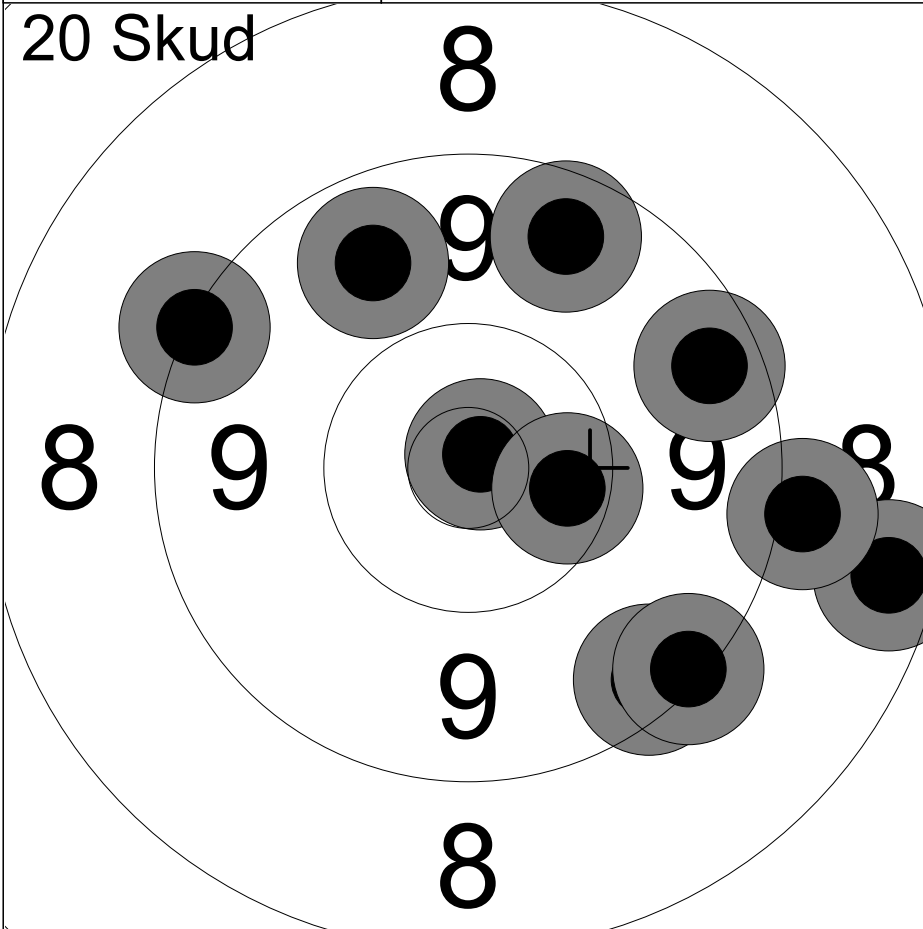

1:	10.8x	↗
2:	8.5	→
3:	9.0	→
4:	9.4	↘
5:	9.3	↘
6:	9.7	↗
7:	9.2	↗
8:	9.5	↗
9:	9.5	↗
10:	10.4	→

Serie	91 (1x)
Total	91 (1x)

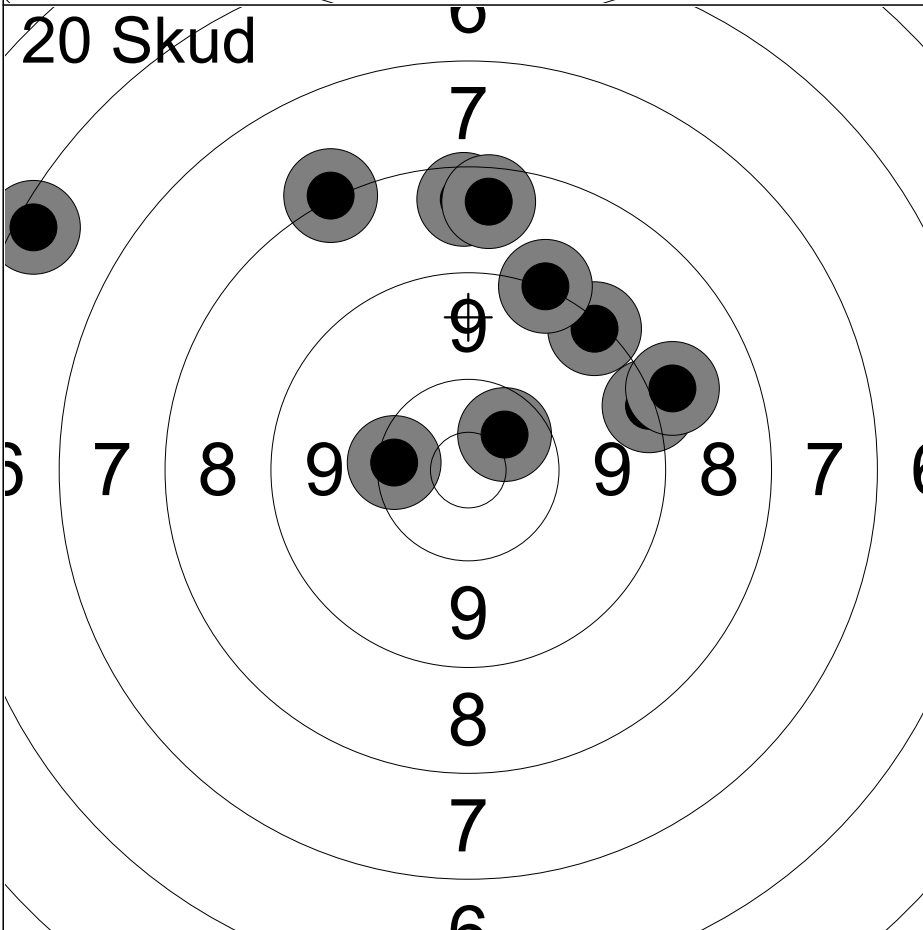

11:	6.3	↖
12:	10.3	←
13:	9.2	↗
14:	8.5	↑
15:	8.5	↑
16:	9.2	↗
17:	9.2	→
18:	10.5x	↗
19:	9.0	→
20:	8.1	↖

Serie	86 (1x)
Total	177 (2x)

Hold 25	Skive 1	Theodor Hejnfelt		
50M		Frederikssund Skytteforening, I	MBK3	
10.08.2024		EM 2024	Hanebjerg Skyttecenter	
Kommentar		Signatur		

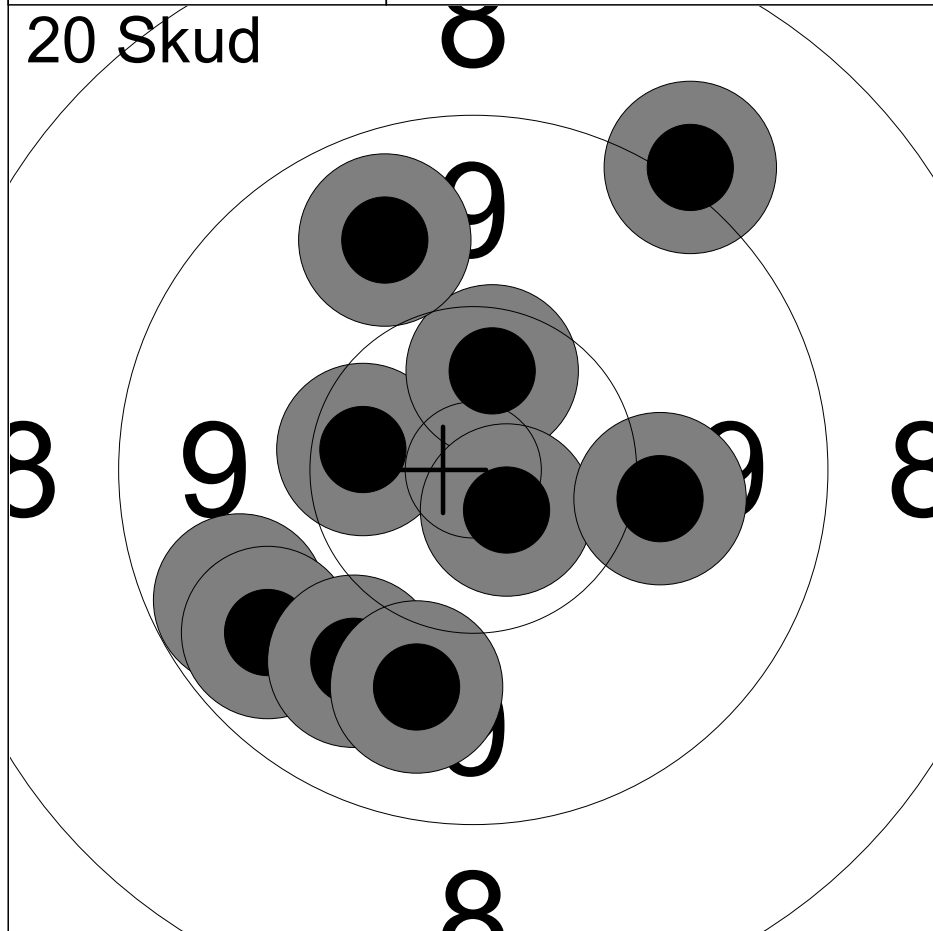

1:	9.6	↙
2:	10.4	↙
3:	9.7	↙
4:	9.8	↙
5:	10.5x	↑
6:	10.7x	↘
7:	9.9	↘
8:	9.7	↑
9:	10.0	→
10:	9.1	↗
Serie		94 (2x)
Total		94 (2x)

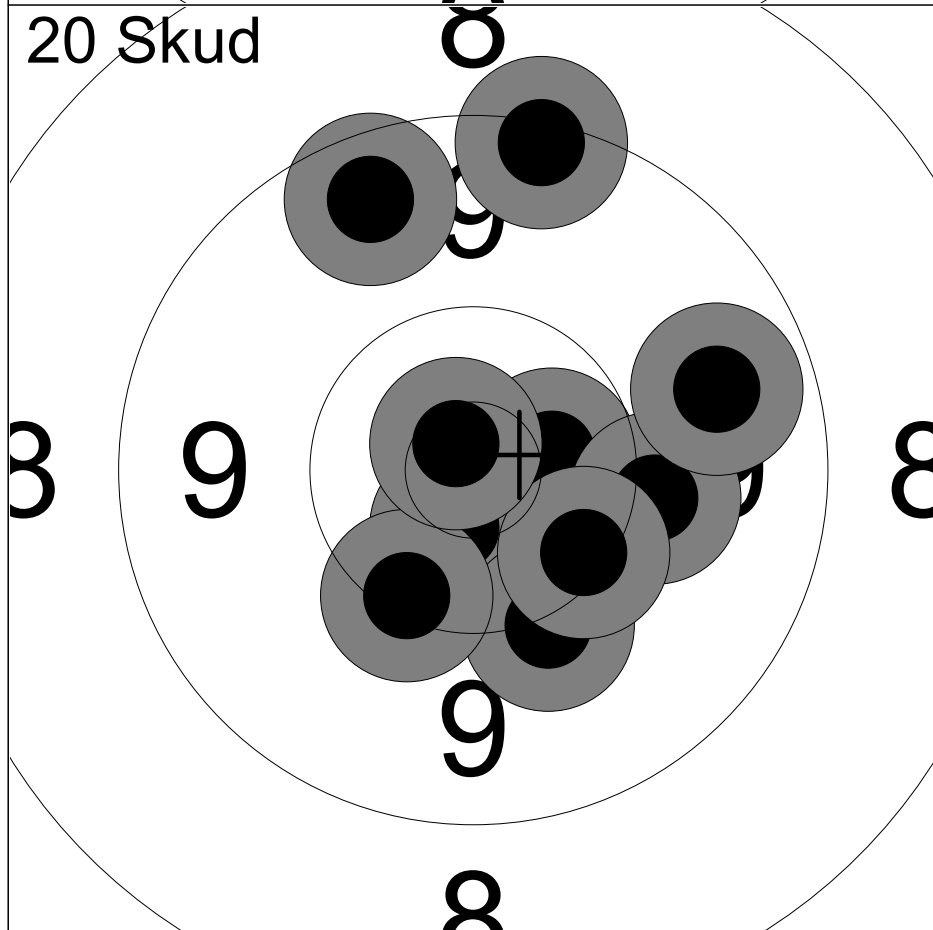

11:	10.6x	→
12:	9.3	↑
13:	10.1	→
14:	10.7x	↘
15:	10.1	↘
16:	10.3	↘
17:	10.3	↘
18:	9.5	↑
19:	9.7	→
20:	10.8x	↖
Serie		97 (3x)
Total		191 (5x)

Hold 25	Skive 3	Amanda Jensen		
50M		Frederikssund Skytteforening, I		MJ2
10.08.2024		EM 2024		Hanebjerg Skyttecenter
Kommentar		Signatur		

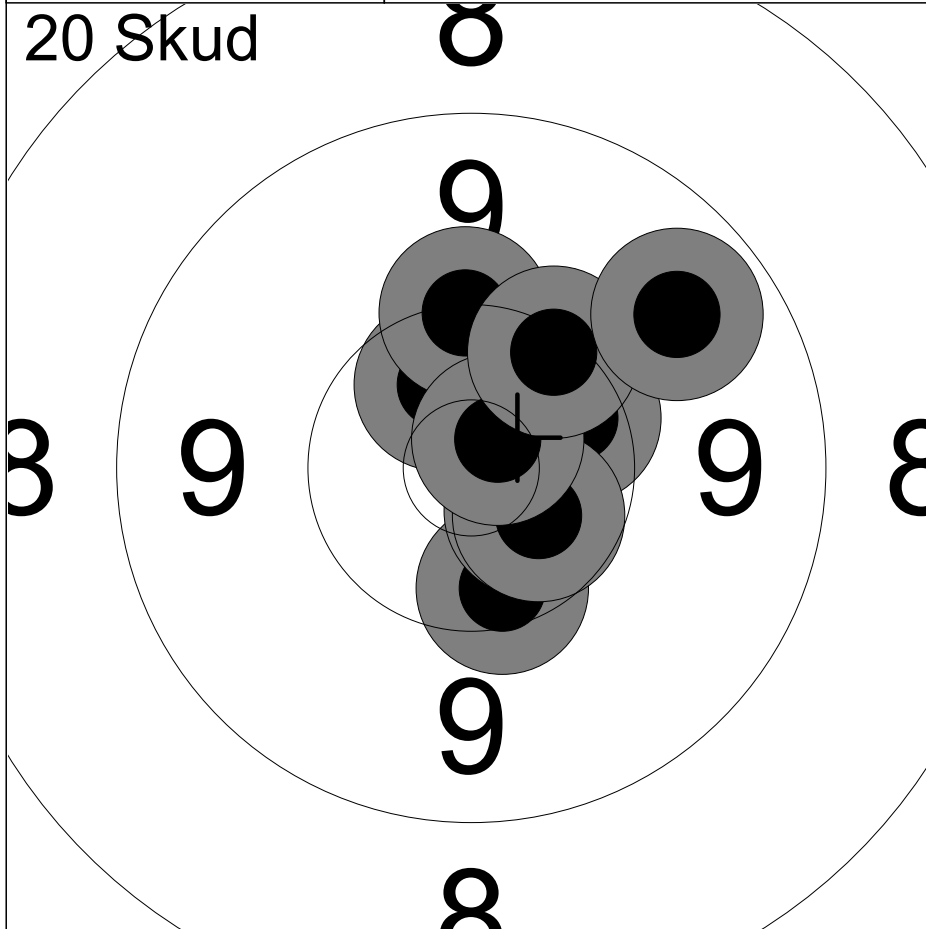

1:	10.5x	↗
2:	10.4	→
3:	10.5x	↖
4:	10.3	↘
5:	10.2	↗
6:	10.6x	↘
7:	10.6x	↘
8:	10.8x	↗
9:	10.3	↗
10:	9.7	↗
Serie		99 (5x)
Total		99 (5x)

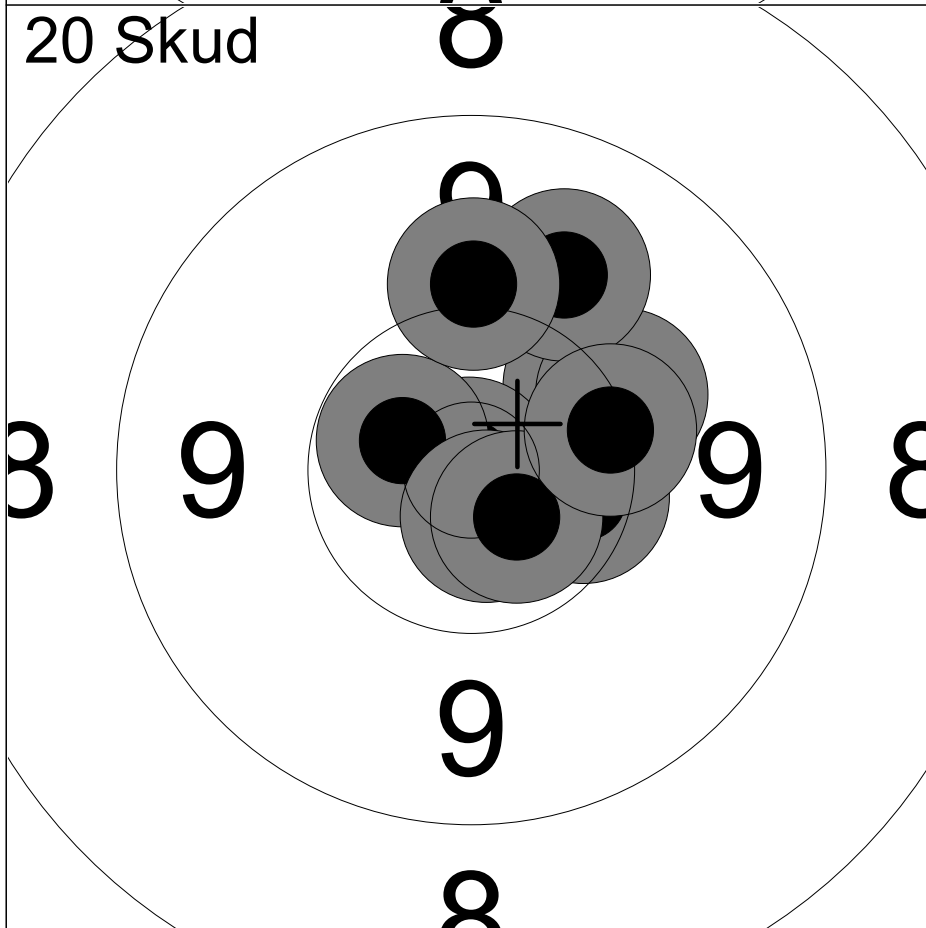

11:	10.2	↗
12:	10.1	→
13:	9.9	↖
14:	10.9x	↖
15:	10.4	→
16:	10.6x	↖
17:	10.7x	↘
18:	10.6x	↘
19:	10.2	→
20:	10.0	↗
Serie		99 (4x)
Total		198 (9x)

Hold 25	Skive 4	Therkel William Haagemann	
50M	Ganløse Skytteforening	MJ1	
10.08.2024	EM 2024	Hanebjerg Skyttecenter	
Kommentar	Signatur		

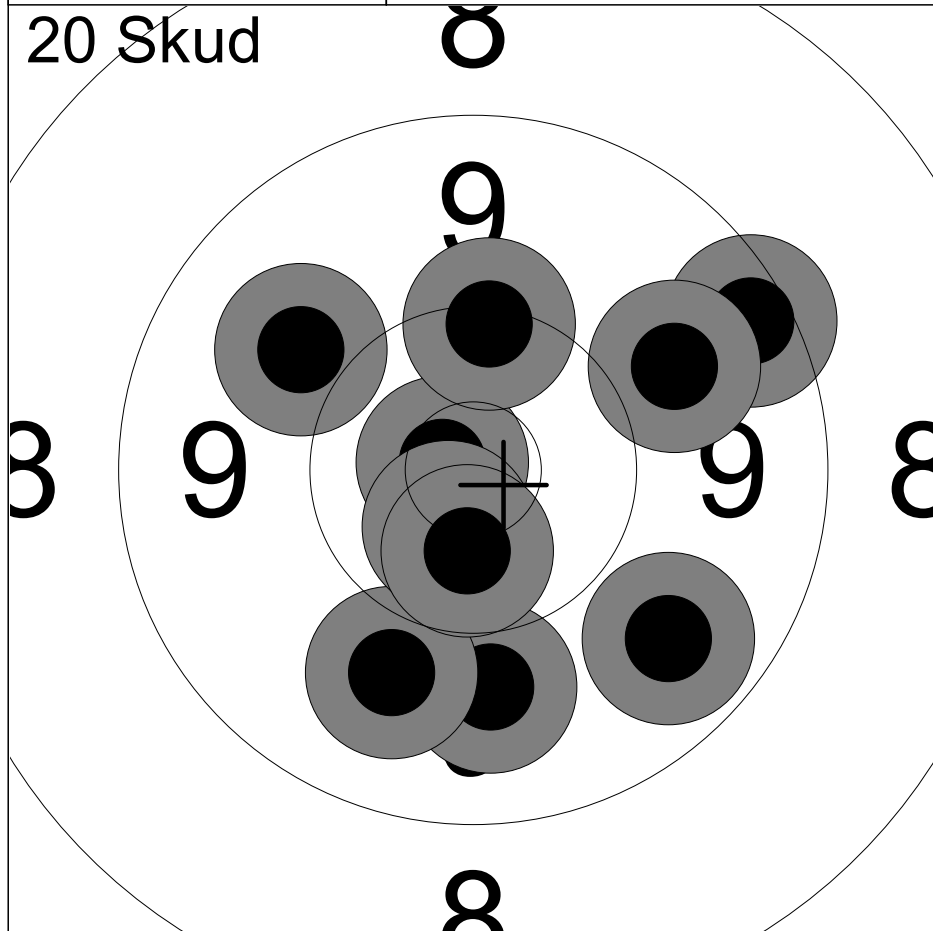

1:	9.9	↖
2:	9.4	↗
3:	10.8x	↖
4:	9.7	↘
5:	9.8	↗
6:	10.2	↑
7:	9.9	↓
8:	9.9	↘
9:	10.7x	↘
10:	10.6x	↓
Serie		94 (3x)
Total		94 (3x)

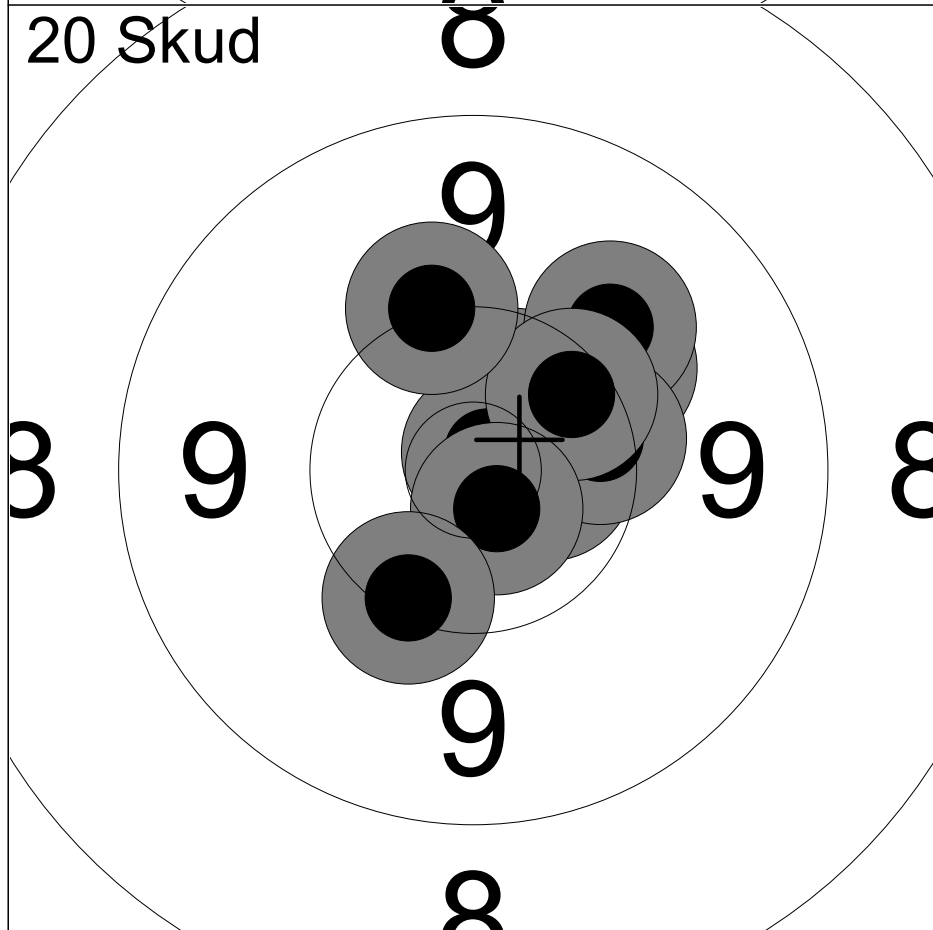

11:	10.5x	↗
12:	10.6x	→
13:	10.1	↗
14:	10.0	↗
15:	10.8x	↗
16:	10.3	→
17:	10.3	↗
18:	10.7x	↘
19:	10.3	↘
20:	10.1	↑
Serie		100 (4x)
Total		194 (7x)

Hold 25	Skive 5	Simon Jansen		
50M		Ganløse Skytteforening		MBK1
10.08.2024		EM 2024		Hanebjerg Skyttecenter
Kommentar		Signatur		

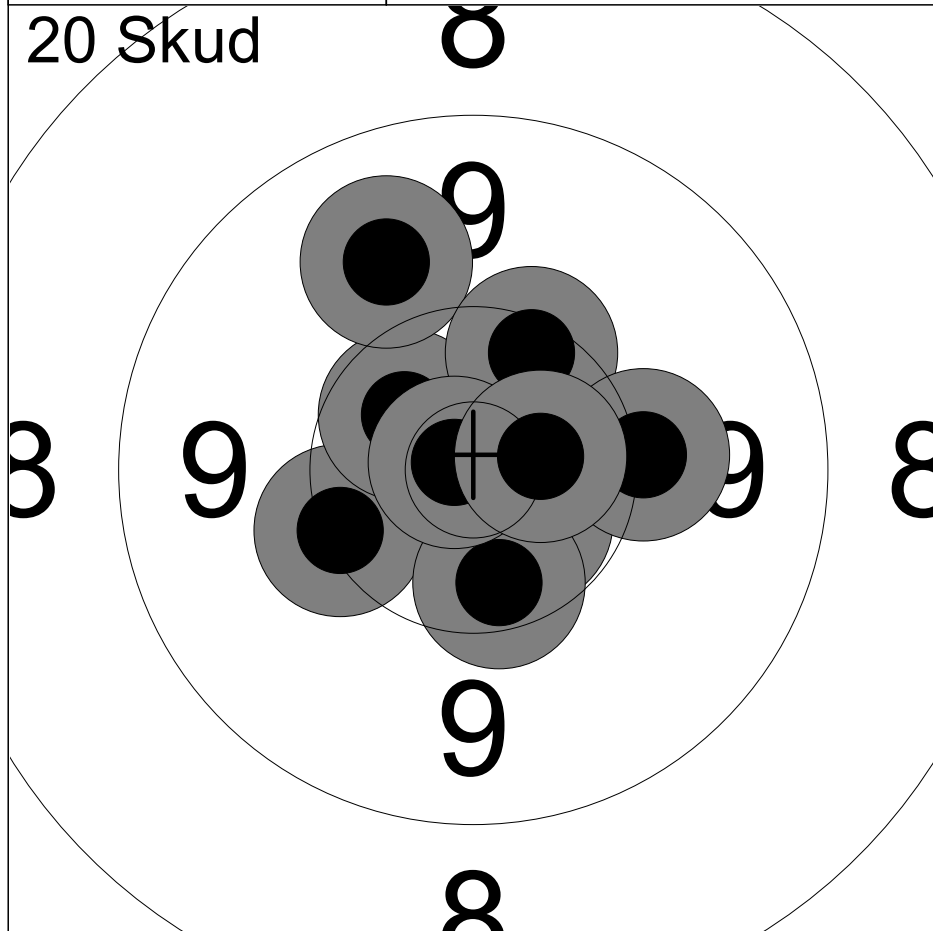

1:	10.6x	↗
2:	10.6x	↘
3:	10.2	↖
4:	10.5x	↗
5:	9.9	↗
6:	10.3	↗
7:	10.4	↘
8:	10.9x	↖
9:	10.1	→
10:	10.6x	→
Serie		99 (5x)
Total		99 (5x)

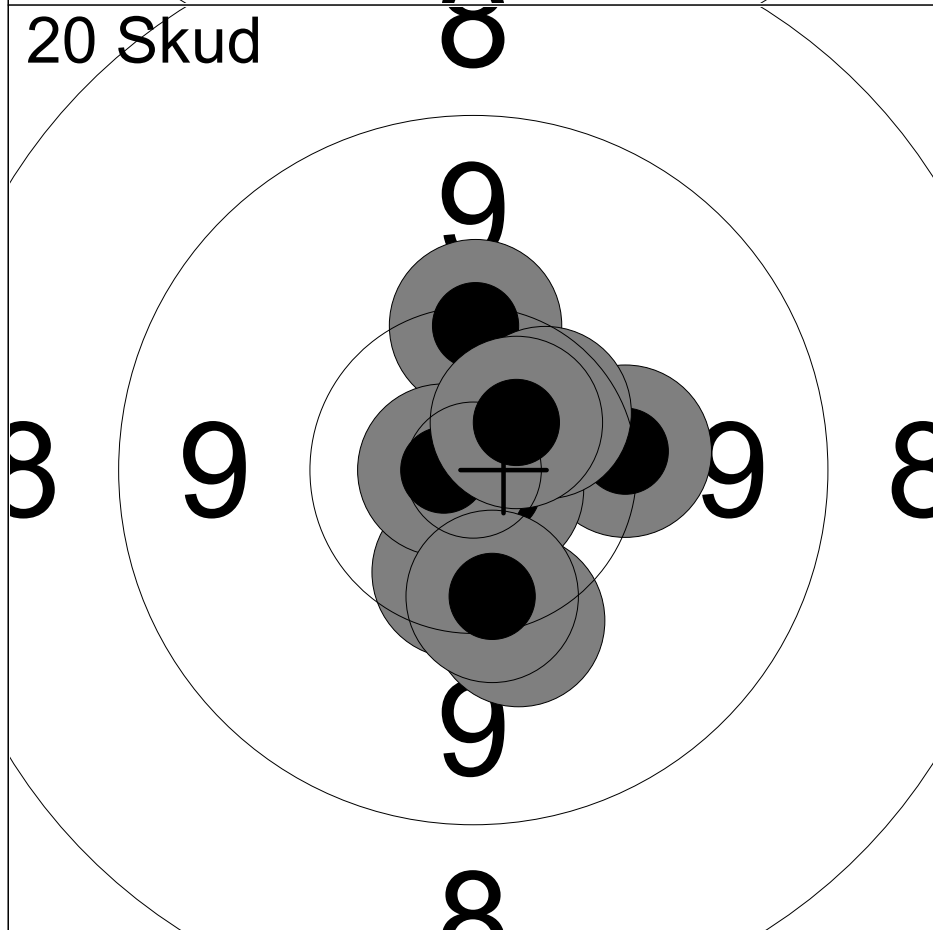

11:	10.4x	↘
12:	10.2	↘
13:	10.2	→
14:	10.9x	↘
15:	10.3	↑
16:	10.8x	↘
17:	10.8x	↖
18:	10.3	↘
19:	10.5x	↗
20:	10.6x	↗
Serie		100 (6x)
Total		199 (11x)

Hold 25	Skive 6	Claus Soares Petersen	
50M	Frederikssund Skytteforening, I	Å1	
10.08.2024	EM 2024	Hanebjerg Skyttecenter	
Kommentar	Signatur		

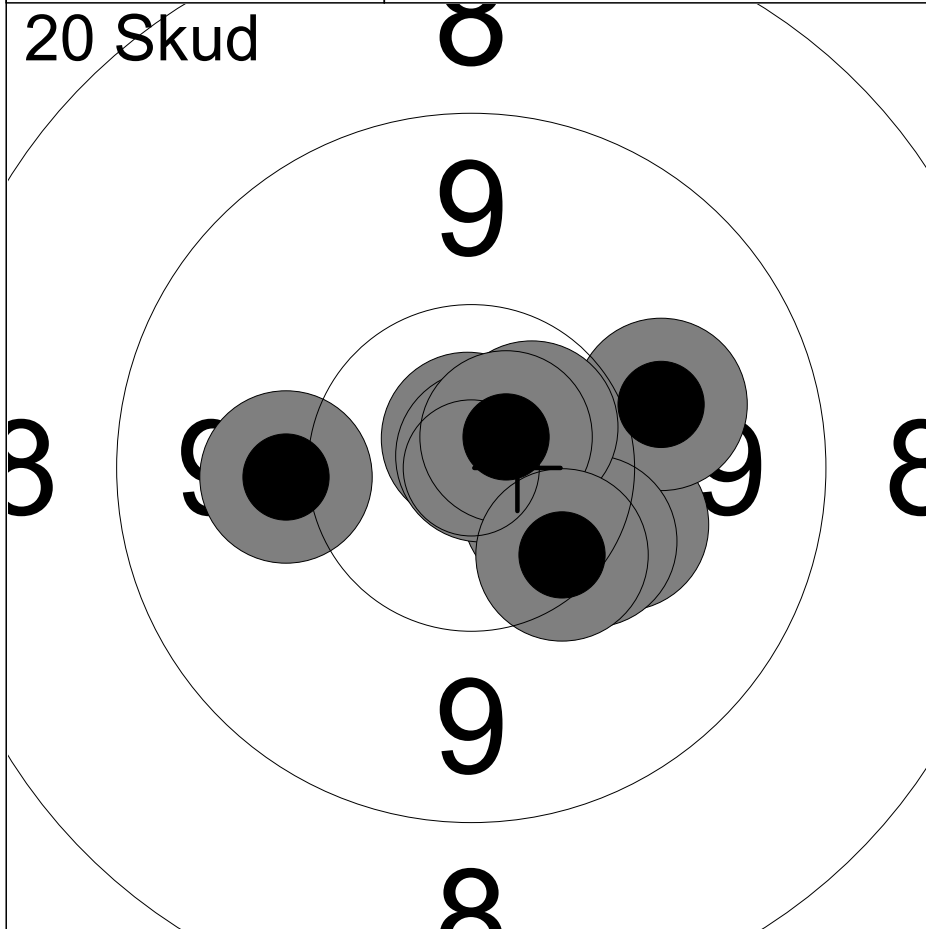

1:	10.8x	↑
2:	10.5x	→
3:	10.9x	↗
4:	10.2	→
5:	10.0	→
6:	10.0	←
7:	10.3	→
8:	10.6x	↗
9:	10.7x	↗
10:	10.3	↘
Serie		100 (5x)
Total		100 (5x)

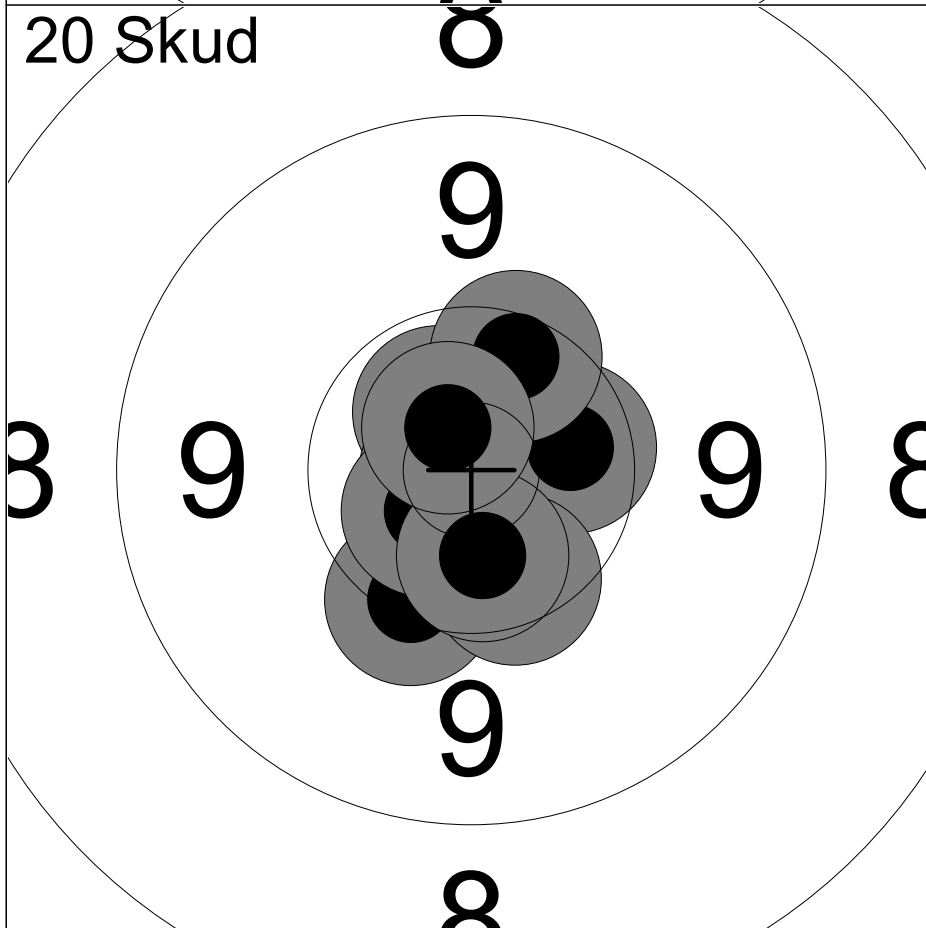

11:	10.3	↘
12:	10.6x	↖
13:	10.8x	←
14:	10.8x	↗
15:	10.5x	→
16:	10.4	↘
17:	10.7x	↖
18:	10.4	↗
19:	10.5x	↘
20:	10.7x	↖
Serie		100 (7x)
Total		200 (12x)

Hold 25	Skive 7	Jeppe Mygind Plaep		
50M	Ølstykke Skytteforening		MBK2	
10.08.2024	EM 2024	Hanebjerg Skyttecenter		
Kommentar	Signatur			

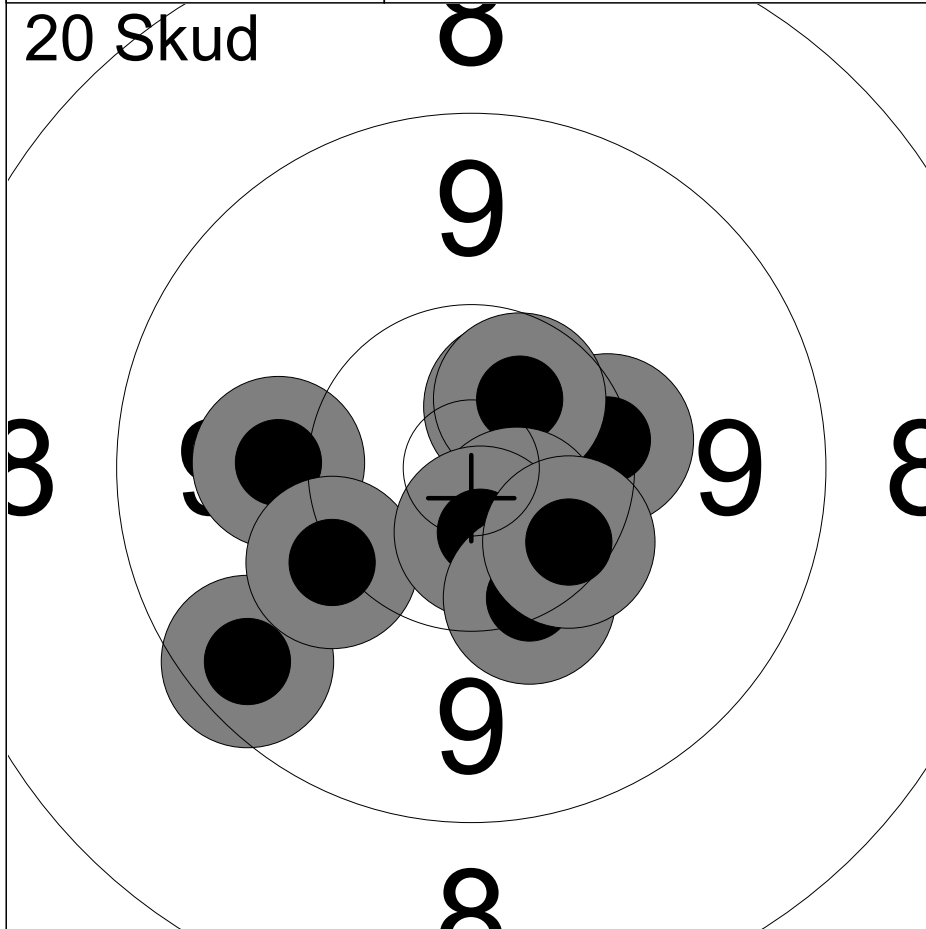

1:	10.0	←
2:	9.5	↙
3:	10.3	→
4:	10.1	↙
5:	10.6x	↗
6:	10.5x	↗
7:	10.6x	↘
8:	10.6x	↘
9:	10.3	↘
10:	10.4	↘
Serie		99 (4x)
Total		99 (4x)

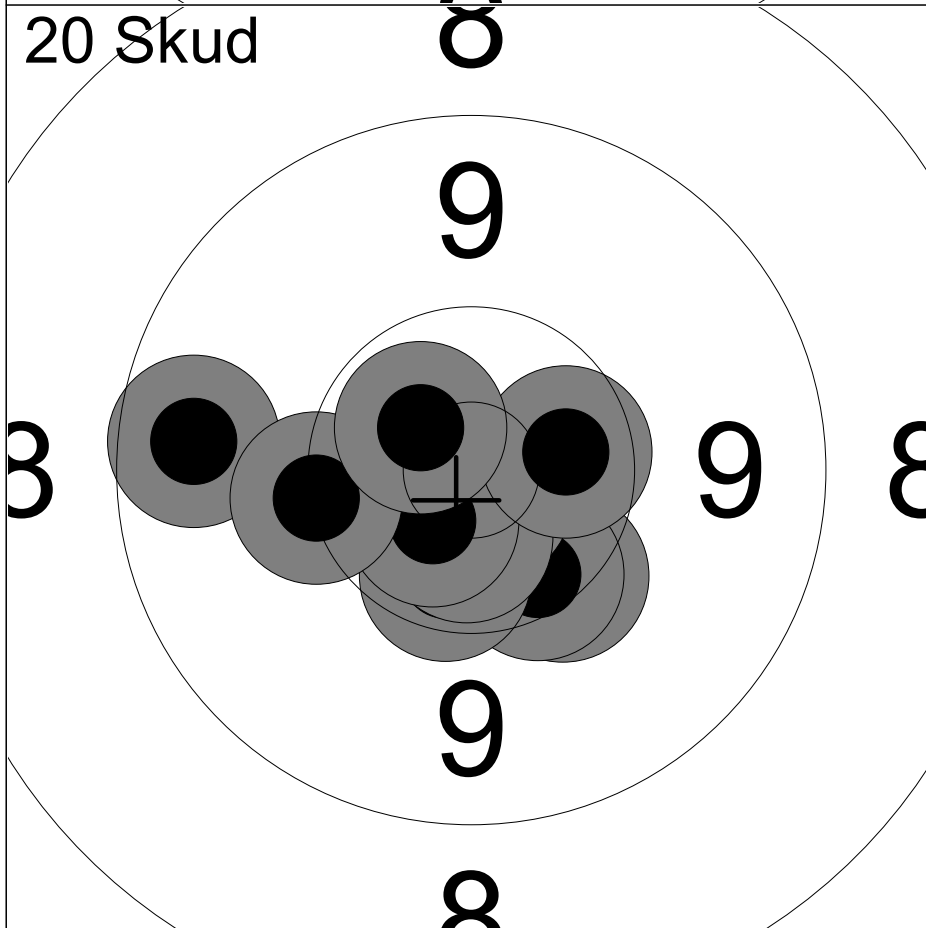

11:	10.3	↘
12:	10.4	↘
13:	10.8x	↘
14:	10.4x	↘
15:	10.6x	↘
16:	9.6	←
17:	10.6x	↙
18:	10.5x	→
19:	10.2	←
20:	10.6x	↖
Serie		99 (6x)
Total		198 (10x)

Hold 25	Skive 8	Marcus Elleroed Hansen		
50M		Ganløse Skytteforening		MJ2
10.08.2024		EM 2024		Hanebjerg Skyttecenter
Kommentar		Signatur		

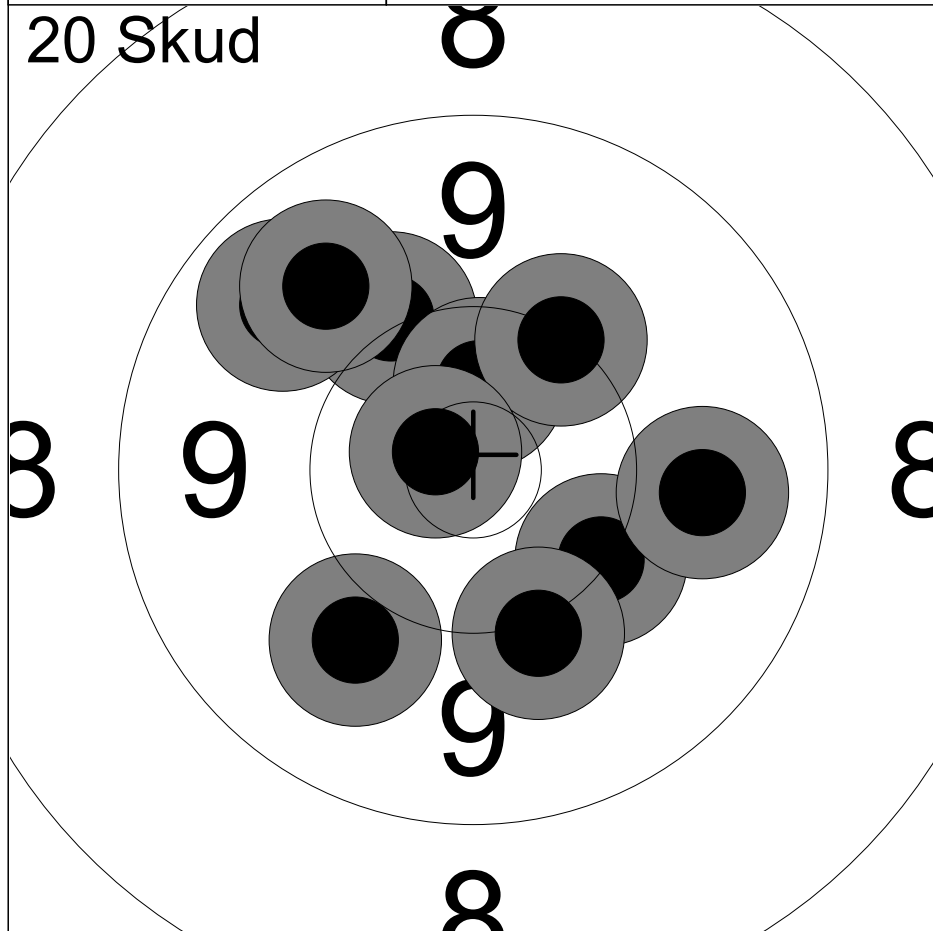

1:	10.1	↗
2:	9.7	↗
3:	9.8	↗
4:	10.5x	↑
5:	10.2	↗
6:	10.2	↘
7:	10.1	↘
8:	9.9	↘
9:	10.7x	↗
10:	9.8	→

Serie	96 (2x)
Total	96 (2x)

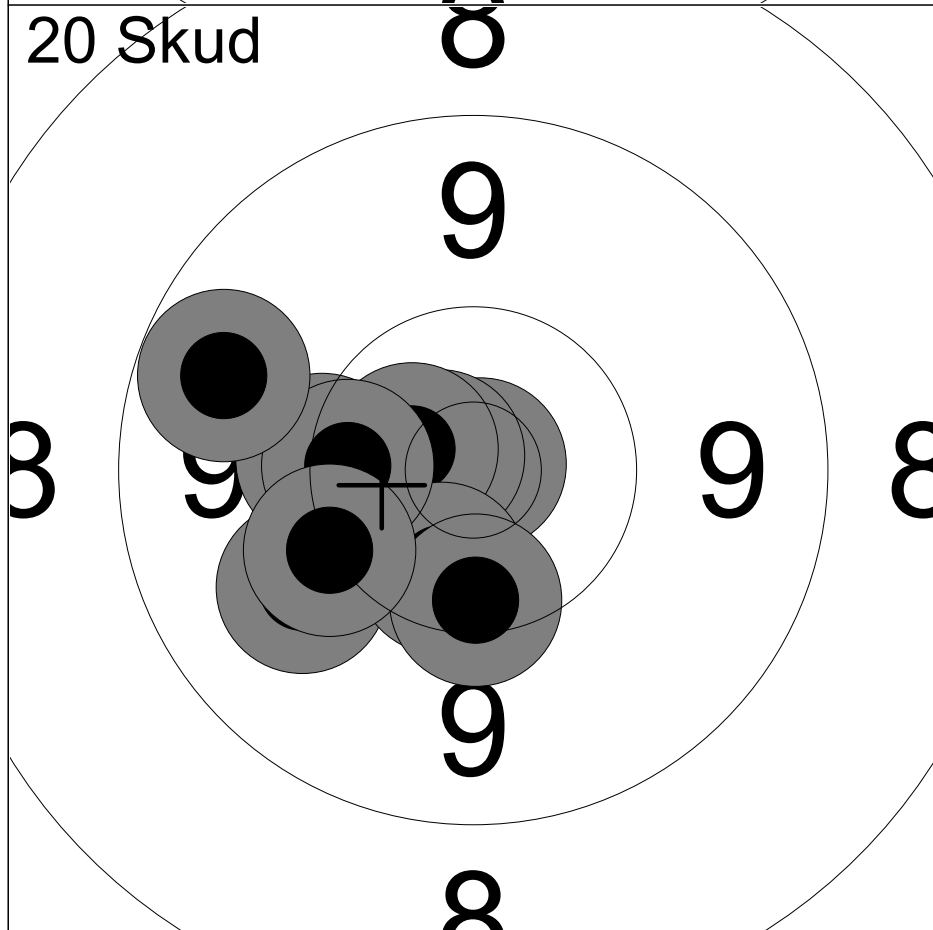

11:	10.9x	↗
12:	9.9	↖
13:	10.8x	↖
14:	10.6x	↖
15:	10.2	←
16:	10.4x	↘
17:	10.3	←
18:	10.3	↓
19:	10.2	↖
20:	9.6	↖

Serie	98 (4x)
Total	194 (6x)

Hold 25	Skive 9	Magnus Bjoernberg Levisen	
50M	Ølstykke Skytteforening	MJ2	
10.08.2024	EM 2024	Hanebjerg Skyttecenter	
Kommentar	Signatur		

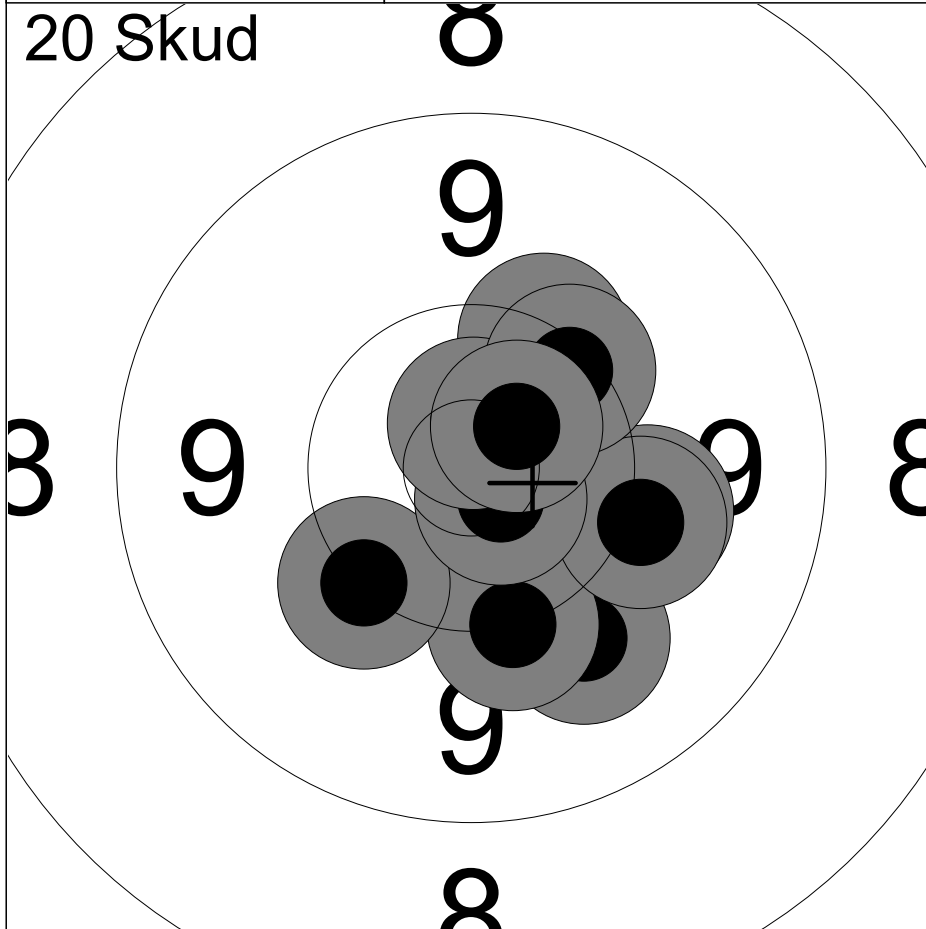

1:	10.0	↘
2:	10.2	↘
3:	10.2	↗
4:	10.2	↙
5:	10.1	→
6:	10.1	→
7:	10.7x	↘
8:	10.7x	↑
9:	10.3	↗
10:	10.7x	↗
Serie		100 (3x)
Total		100 (3x)

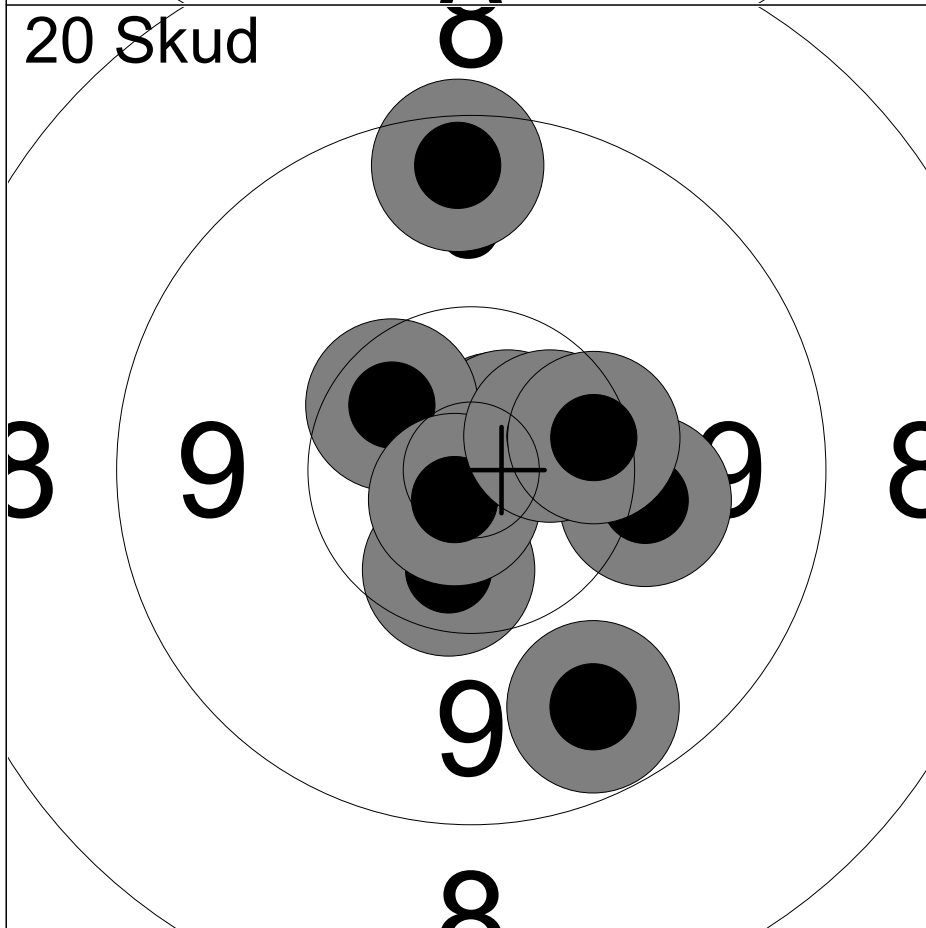

11:	10.8x	↗
12:	9.6	↘
13:	9.4	↑
14:	10.7x	↗
15:	10.1	→
16:	10.5x	↗
17:	10.5x	↘
18:	10.8x	↘
19:	10.5x	↗
20:	10.3	→
Serie		98 (6x)
Total		198 (9x)

Hold 25	Skive 10	Jeannette Frost		
50M		Skyttelaugget Kgs. Lyngby		MST2
10.08.2024		EM 2024		Hanebjerg Skyttecenter
Kommentar		Signatur		

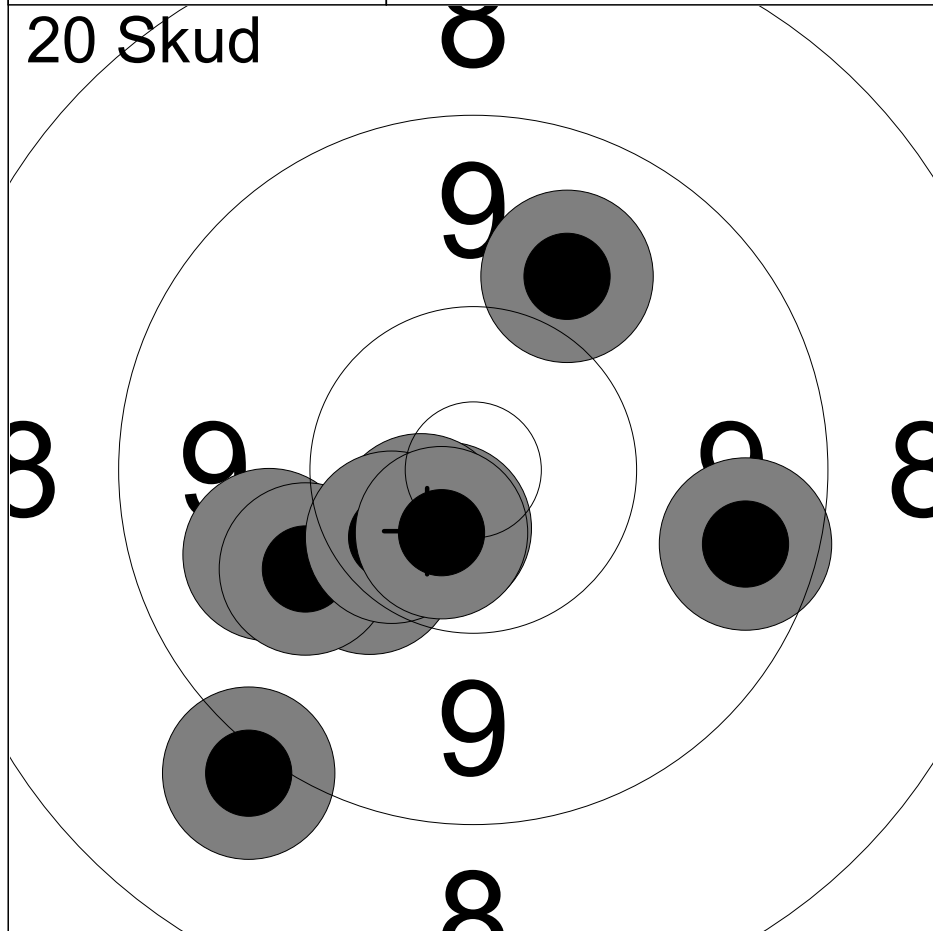

1:	10.3	↙
2:	9.1	↘
3:	9.9	↙
4:	10.0	↙
5:	9.6	→
6:	9.9	↗
7:	10.6x	↘
8:	10.6x	↘
9:	10.4x	↙
10:	10.6x	↘

Serie	96 (4x)
Total	96 (4x)

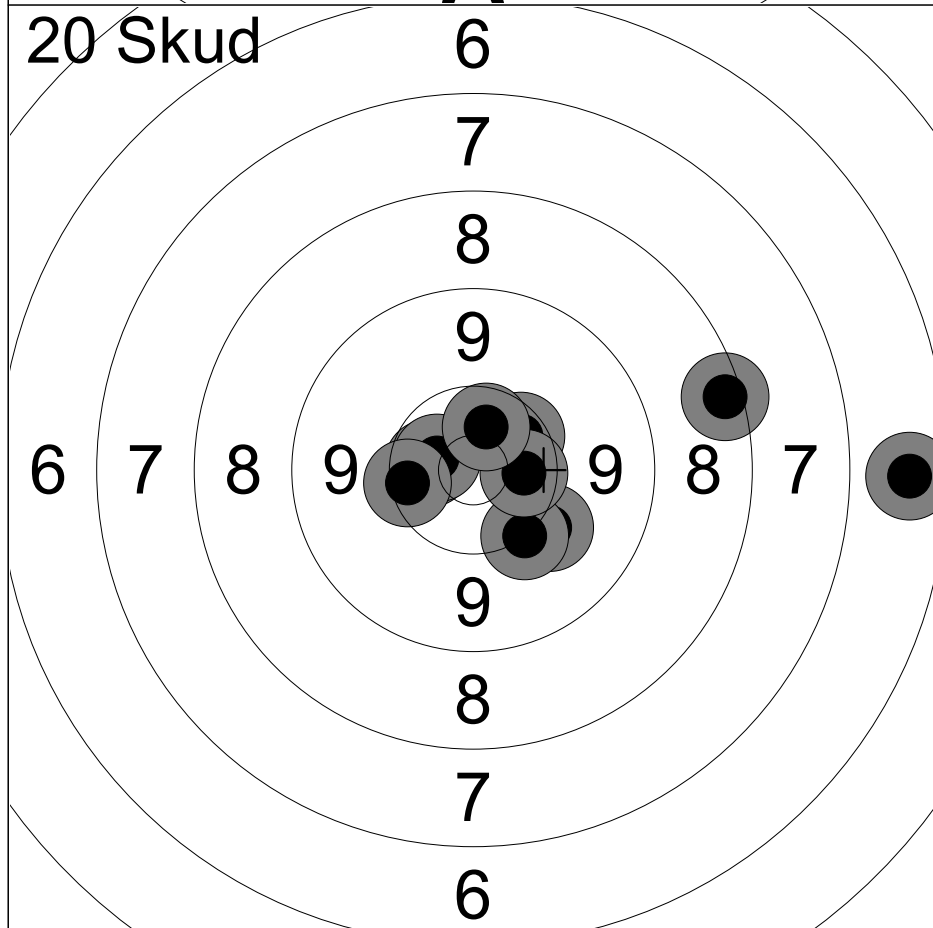

11:	10.0	↘
12:	10.4	↗
13:	10.5x	↙
14:	10.6x	↙
15:	10.2	↘
16:	8.3	→
17:	10.3	↙
18:	10.5x	→
19:	6.6	→
20:	10.5x	↗

Serie	94 (4x)
Total	190 (8x)

Hold 25	Skive 11	Sara Aaslev Noerager Bay	
50M		Ølstykke Skytteforening	J1
10.08.2024		EM 2024	Hanebjerg Skyttecenter
Kommentar		Signatur	

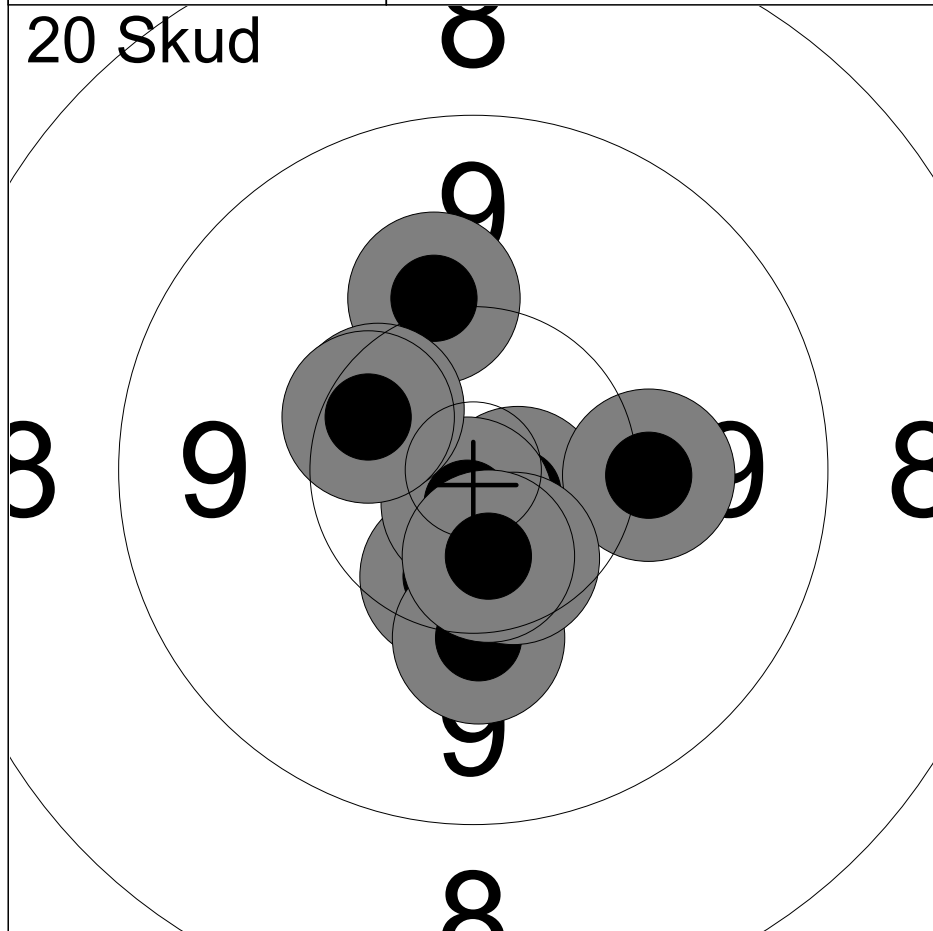

1:	10.1	↖
2:	10.4x	↘
3:	10.1	↘
4:	10.7x	↘
5:	10.8x	↘
6:	10.1	→
7:	10.4	↗
8:	10.4	↗
9:	10.5x	↘
10:	10.5x	↘
Serie		100 (5x)
Total		100 (5x)

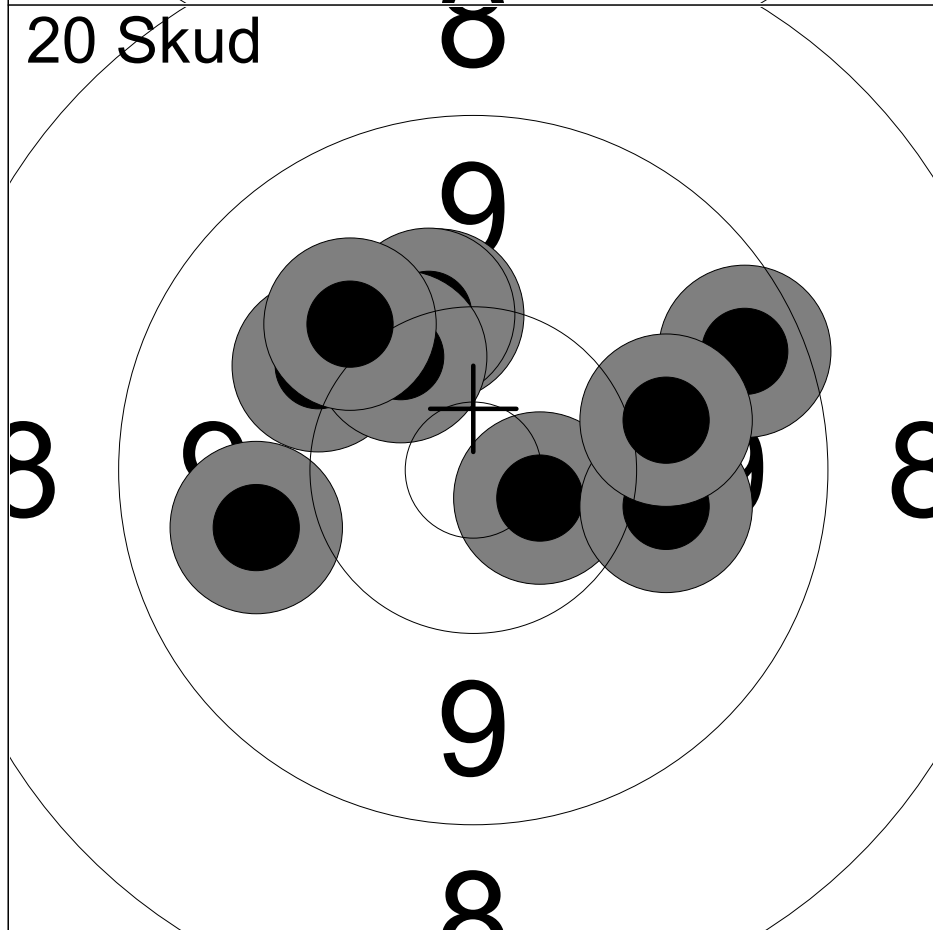

11:	10.2	↖
12:	10.0	↗
13:	10.6x	↘
14:	10.2	↗
15:	10.0	↘
16:	9.5	↗
17:	10.0	→
18:	10.3	↗
19:	10.0	↗
20:	9.9	↖
Serie		98 (1x)
Total		198 (6x)

Hold 25	Skive 12	Ida Aaslev Noerager Bay	
50M	Ølstykke Skytteforening	J1	
10.08.2024	EM 2024	Hanebjerg Skyttecenter	
Kommentar	Signatur		

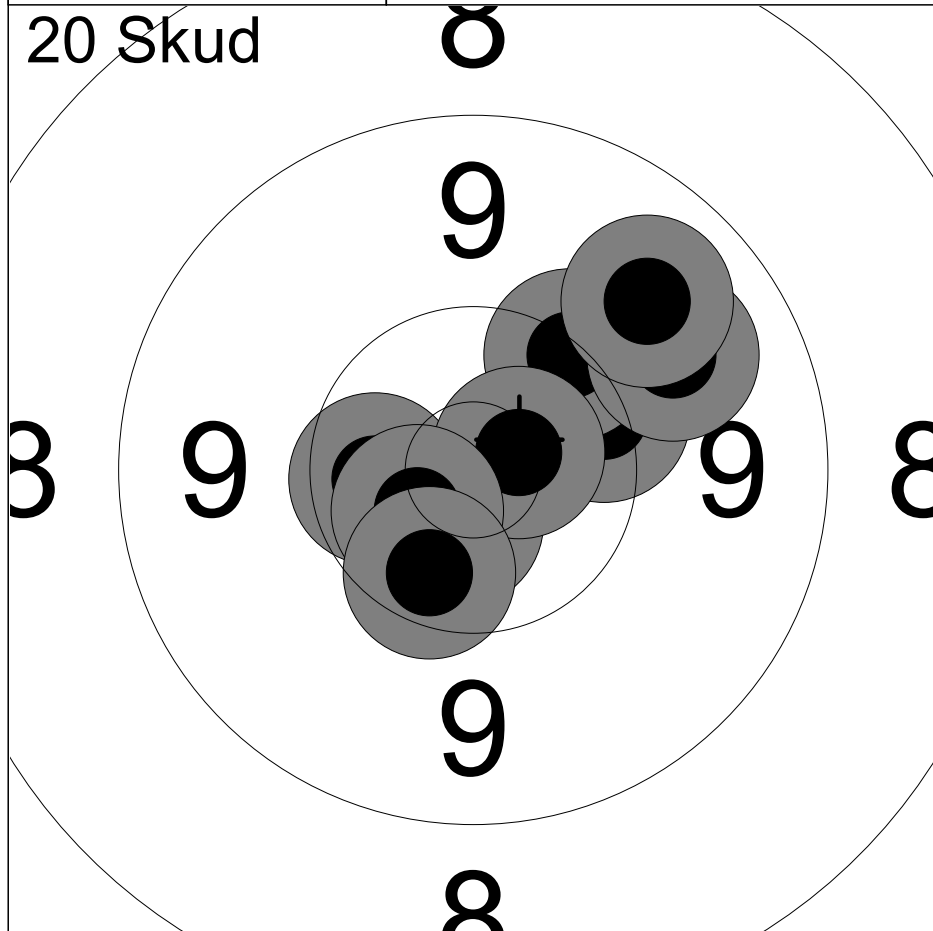

1:	10.7x	↓
2:	10.5x	←
3:	10.2	↗
4:	10.3	↗
5:	10.2	↗
6:	10.7x	↗
7:	9.8	↗
8:	9.8	↗
9:	10.6x	↙
10:	10.4	↓
Serie		98 (4x)
Total		98 (4x)

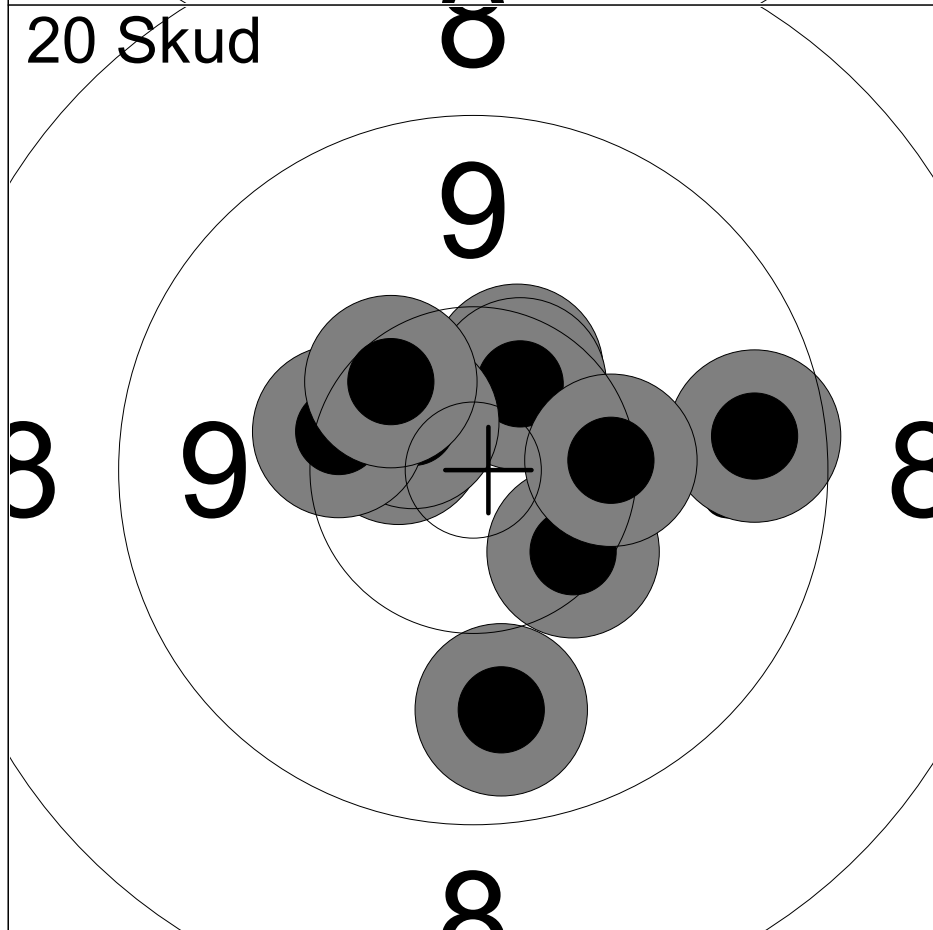

11:	9.8	↓
12:	10.6x	↙
13:	10.4x	↗
14:	10.5x	↗
15:	10.6x	↗
16:	10.3	←
17:	10.4	↗
18:	10.3	↓
19:	9.5	→
20:	10.3	→
Serie		98 (4x)
Total		196 (8x)

Hold 26	Skive 1	Noah Misfeldt Kvist-Andersen	
50M	Ganløse Skytteforening	MBK1	
10.08.2024	EM 2024	Hanebjerg Skyttecenter	
Kommentar	Signatur		



1:	10.9x	←
2:	10.7x	↙
3:	10.5x	←
4:	10.5x	↙
5:	10.5x	←
6:	10.7x	↘
7:	10.4	←
8:	10.3	↘
9:	10.4	↘
10:	10.1	↘
Serie		100 (6x)
Total		100 (6x)

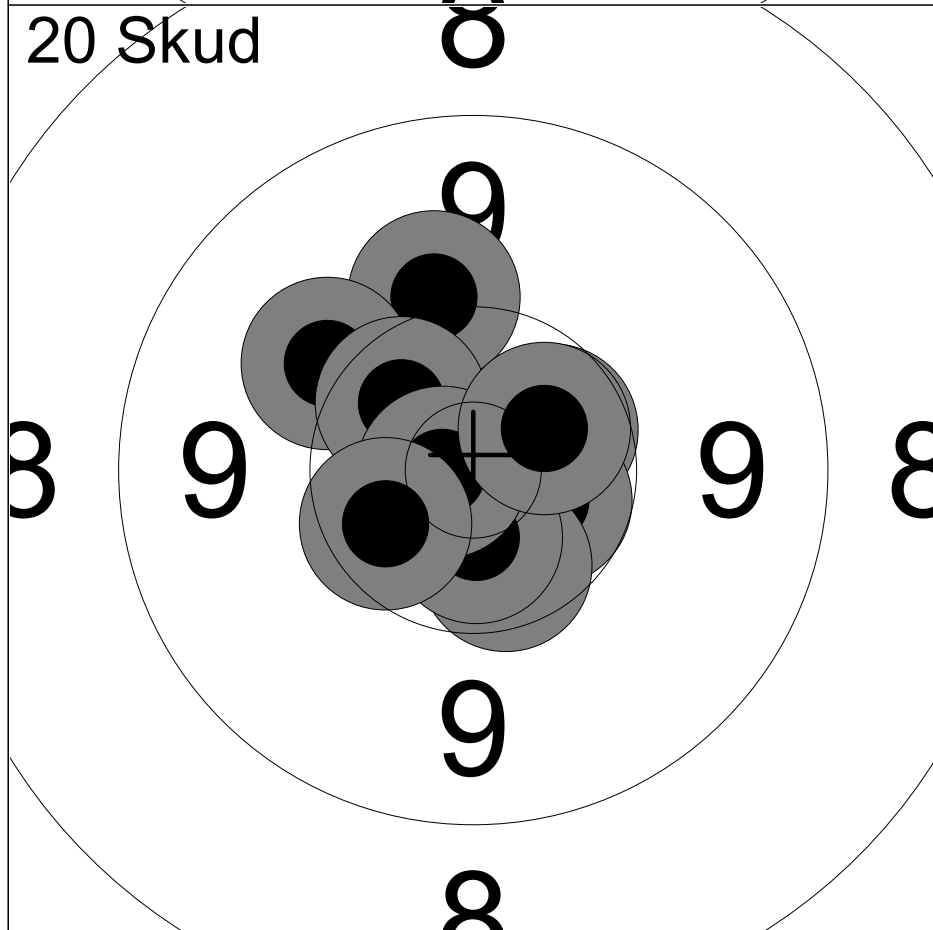

11:	10.5x	↗
12:	10.1	↑
13:	10.1	↗
14:	10.6x	↘
15:	10.5x	↗
16:	10.5x	↘
17:	10.6x	↘
18:	10.8x	←
19:	10.5x	↙
20:	10.6x	↗
Serie		100 (8x)
Total		200 (14x)

Hold 26	Skive 2	Viktor Lund-Vogensen		
50M	Ganløse Skytteforening		MBK1	
10.08.2024	EM 2024	Hanebjerg Skyttecenter		
Kommentar	Signatur			



1:	10.9x	↘
2:	10.4	↗
3:	10.7x	↘
4:	9.7	↙
5:	10.3	↗
6:	10.7x	→
7:	10.7x	→
8:	10.5x	↘
9:	10.6x	↙
10:	10.6x	↓
Serie		99 (7x)
Total		99 (7x)

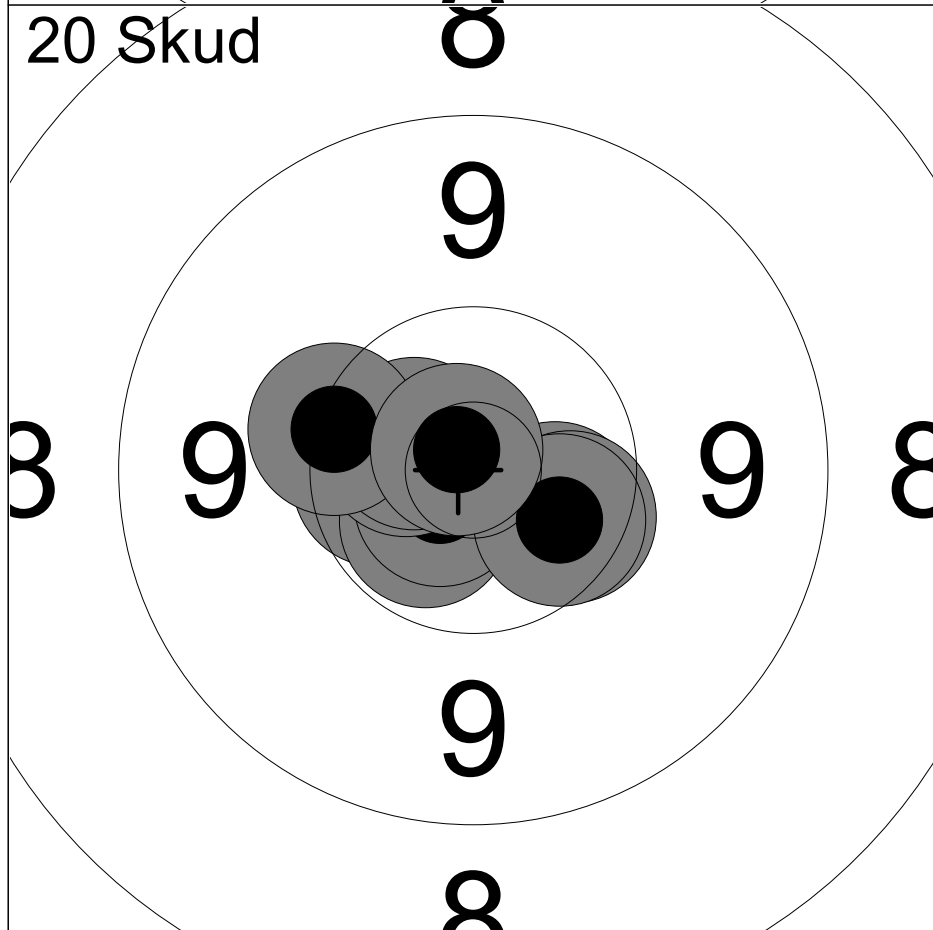

11:	10.5x	↙
12:	10.6x	↘
13:	10.5x	↘
14:	10.4x	↘
15:	10.7x	↙
16:	10.6x	↖
17:	10.6x	↖
18:	10.2	↖
19:	10.5x	↘
20:	10.8x	↗
Serie		100 (9x)
Total		199 (16x)

Hold 26	Skive 3	Emil Lund-Vogensen	
50M	Ganløse Skytteforening		MJ1
10.08.2024	EM 2024	Hanebjerg Skyttecenter	
Kommentar	Signatur		

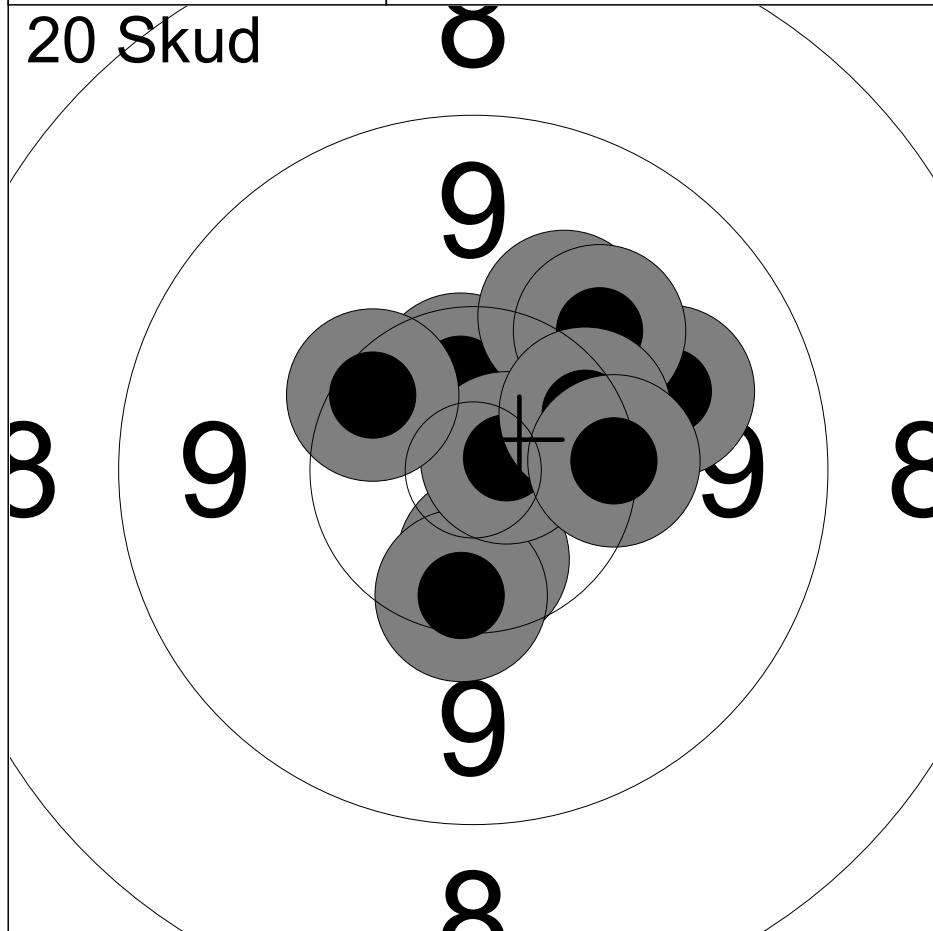

1:	10.5x	↓
2:	10.5x	↑
3:	10.3	↓
4:	10.1	↗
5:	10.8x	→
6:	9.9	↗
7:	10.0	↗
8:	10.3	↗
9:	10.3	↖
10:	10.3	→
Serie		99 (3x)
Total		99 (3x)

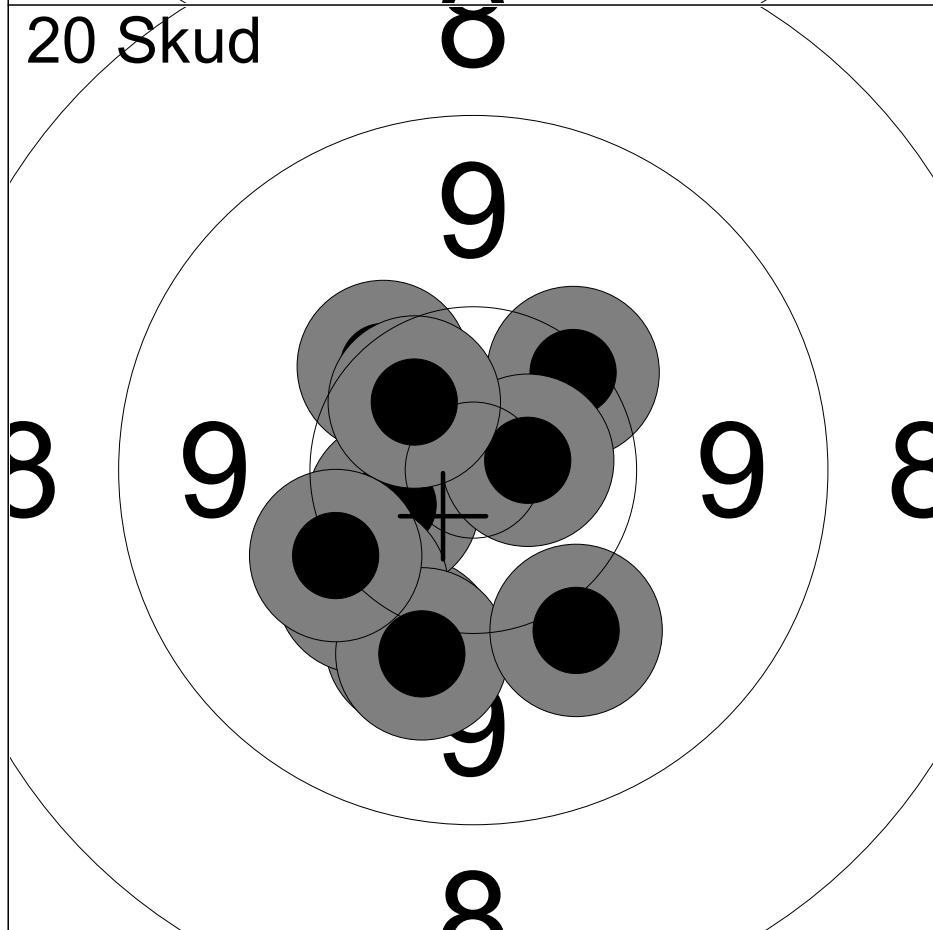

11:	10.3	↗
12:	10.1	↓
13:	10.5x	←
14:	10.7x	→
15:	10.2	↖
16:	10.0	↓
17:	10.3	↗
18:	10.5x	↗
19:	10.0	↓
20:	10.2	↖
Serie		100 (3x)
Total		199 (6x)

Hold 26	Skive 4	Frederik Lund-Vogensen	
50M	Ganløse Skytteforening	MBK1	
10.08.2024	EM 2024	Hanebjerg Skyttecenter	
Kommentar	Signatur		

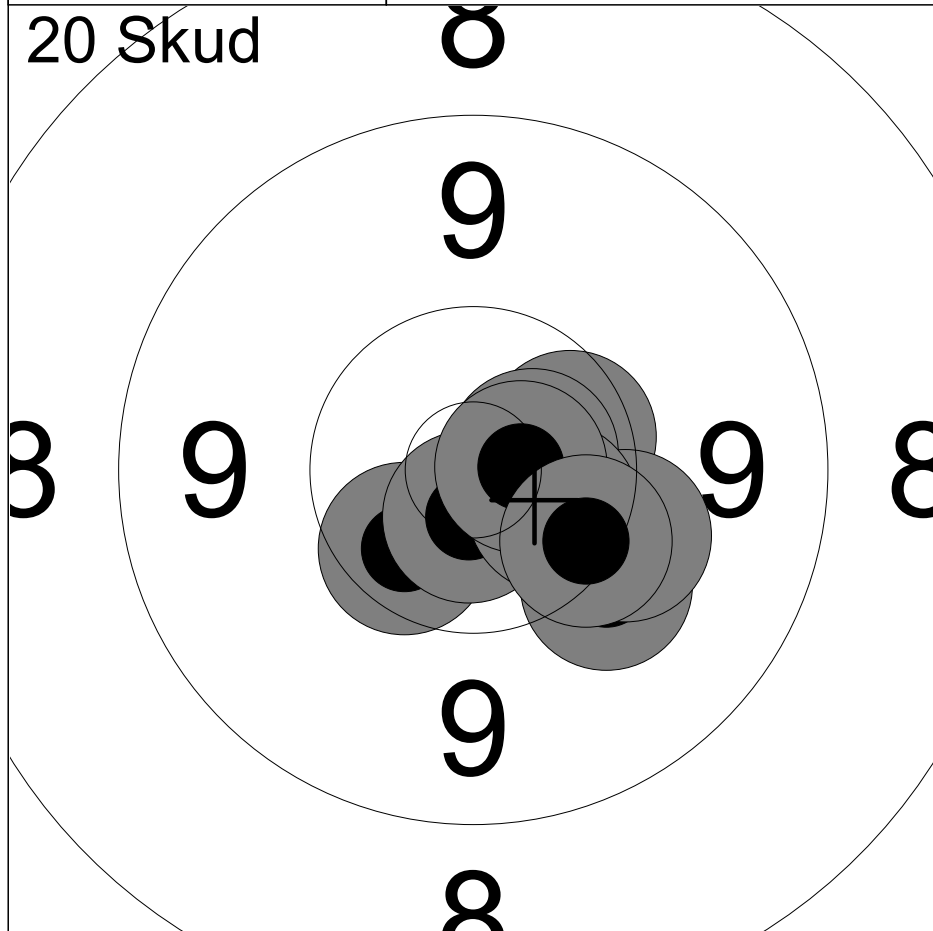

1:	10.4x	↙
2:	10.7x	↓
3:	10.1	↘
4:	10.2	↘
5:	10.5x	→
6:	10.1	↘
7:	10.7x	→
8:	10.5x	↘
9:	10.7x	→
10:	10.3	↘
Serie		100 (6x)
Total		100 (6x)

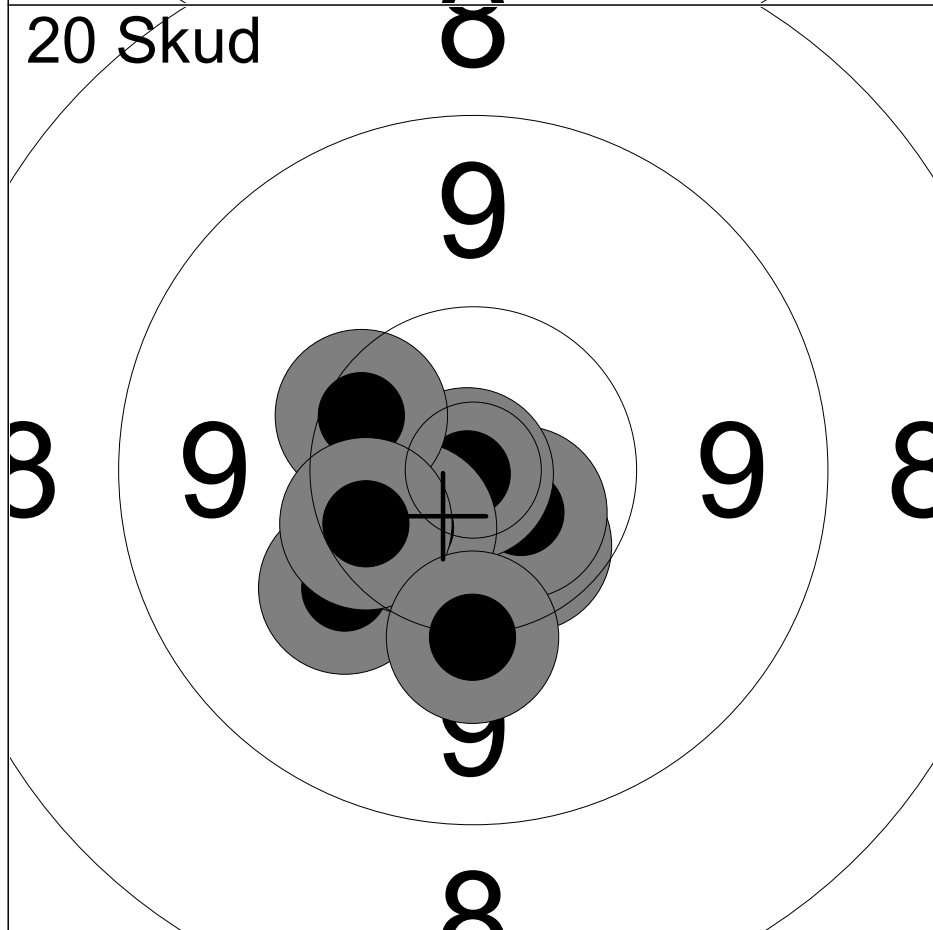

11:	10.6x	↙
12:	10.1	↙
13:	10.5x	↘
14:	10.8x	↘
15:	10.6x	↘
16:	10.9x	↙
17:	10.5x	↙
18:	10.3	↙
19:	10.4	↙
20:	10.1	↓
Serie		100 (6x)
Total		200 (12x)

Hold 26	Skive 5	Thomas Pedersen		
50M	Jørlunde Skytteforening	MST3		
10.08.2024	EM 2024	Hanebjerg Skyttecenter		
Kommentar	Signatur			

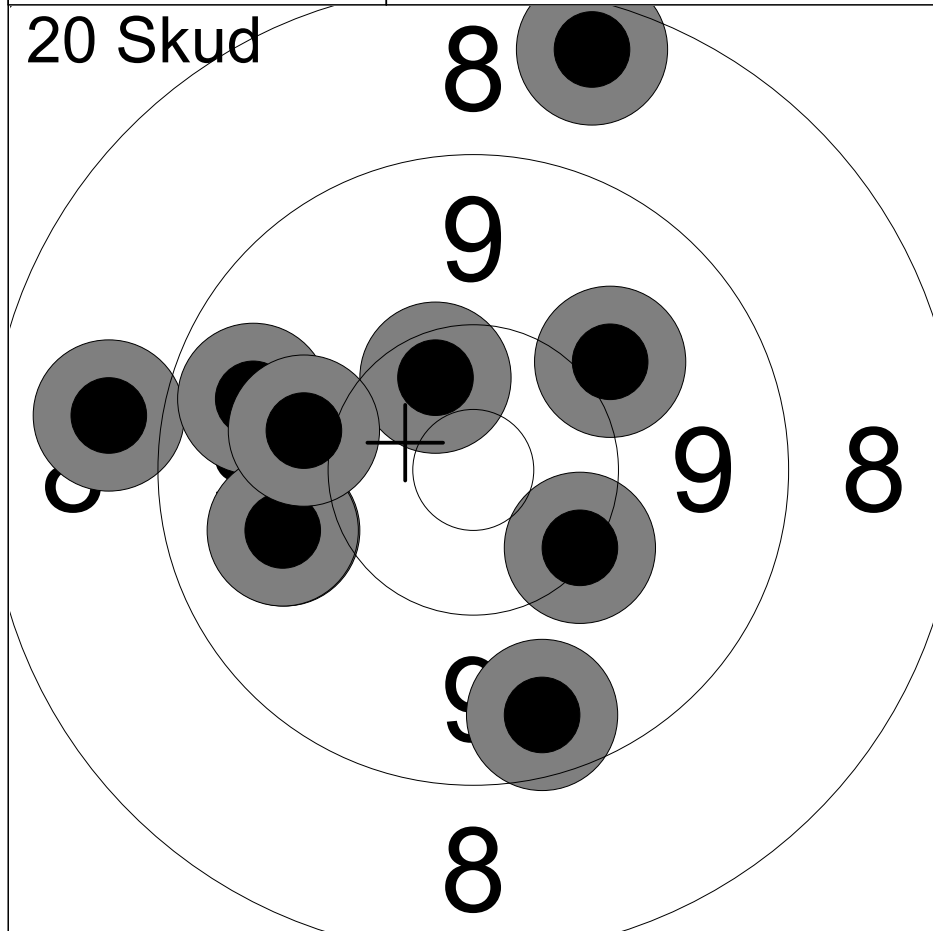

1:	9.9	←
2:	10.2	↘
3:	8.9	←
4:	9.7	←
5:	9.9	←
6:	10.4	↑
7:	8.5	↑
8:	9.5	↘
9:	10.0	↗
10:	10.0	←

Serie	92 (0x)
Total	92 (0x)

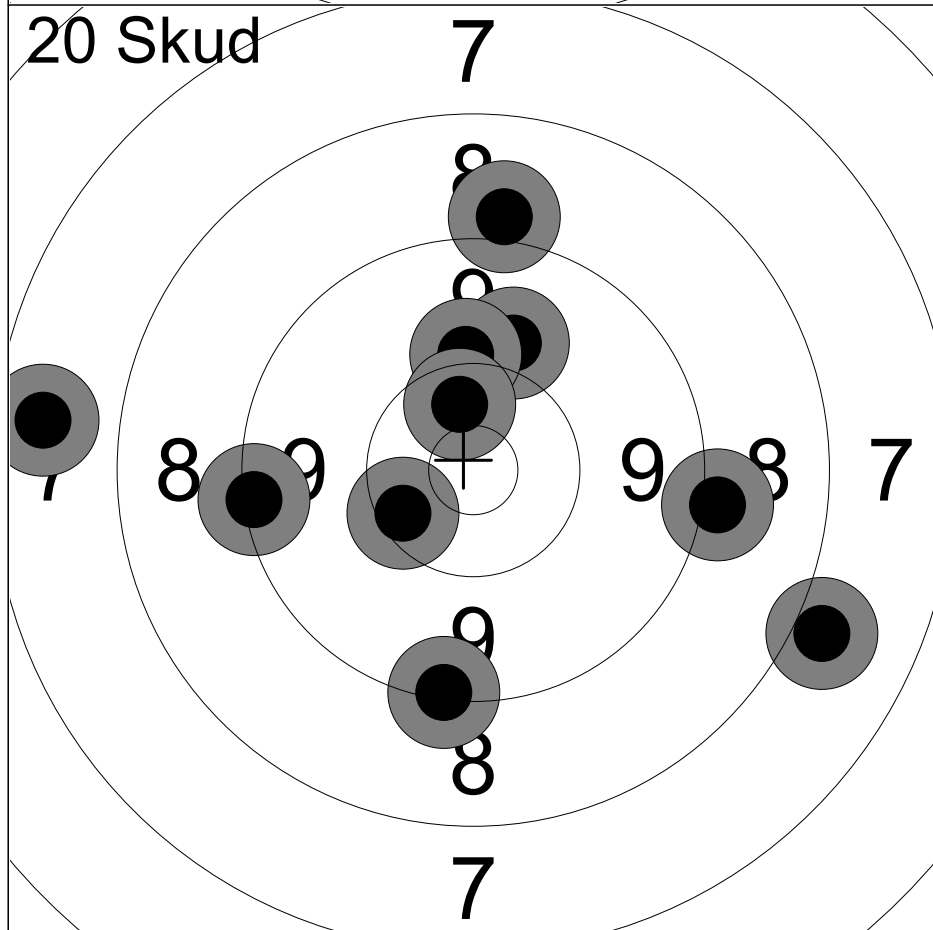

11:	7.6	←
12:	9.2	↘
13:	9.0	→
14:	10.0	↑
15:	10.1	↑
16:	7.9	↘
17:	10.3	←
18:	9.3	←
19:	10.5x	↑
20:	9.0	↑

Serie	90 (1x)
Total	182 (1x)



1:	10.6x	↗
2:	10.8x	→
3:	10.5x	↘
4:	10.6x	↙
5:	10.6x	→
6:	10.9x	↗
7:	10.8x	←
8:	10.7x	←
9:	10.8x	→
10:	10.7x	→

Serie	100 (10x)
Total	100 (10x)

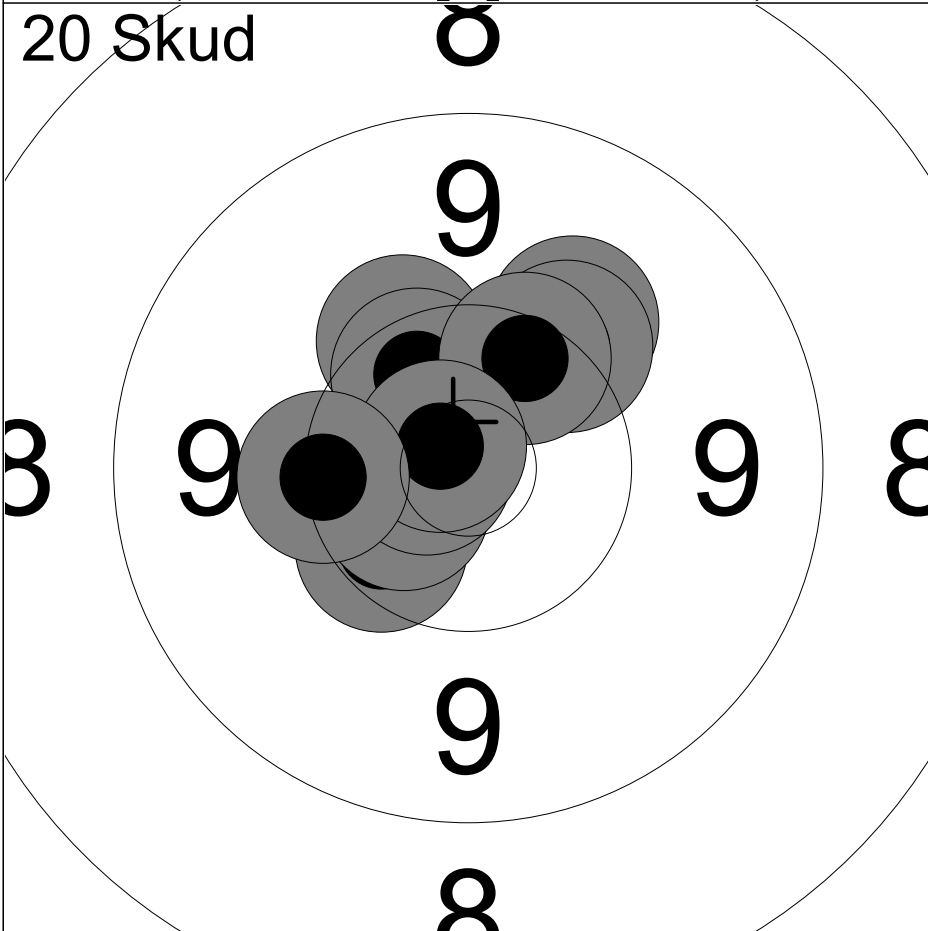

11:	10.1	↗
12:	10.2	↗
13:	10.4	↙
14:	10.3	↖
15:	10.6x	↙
16:	10.7x	←
17:	10.4x	↖
18:	10.4	↗
19:	10.8x	↗
20:	10.2	←

Serie	100 (4x)
Total	200 (14x)

Hold 26	Skive 7	Sebastian Ebert Soerensen	
50M	Frederikssund Skytteforening, I	MJ1	
10.08.2024	EM 2024	Hanebjerg Skyttecenter	
Kommentar	Signatur		

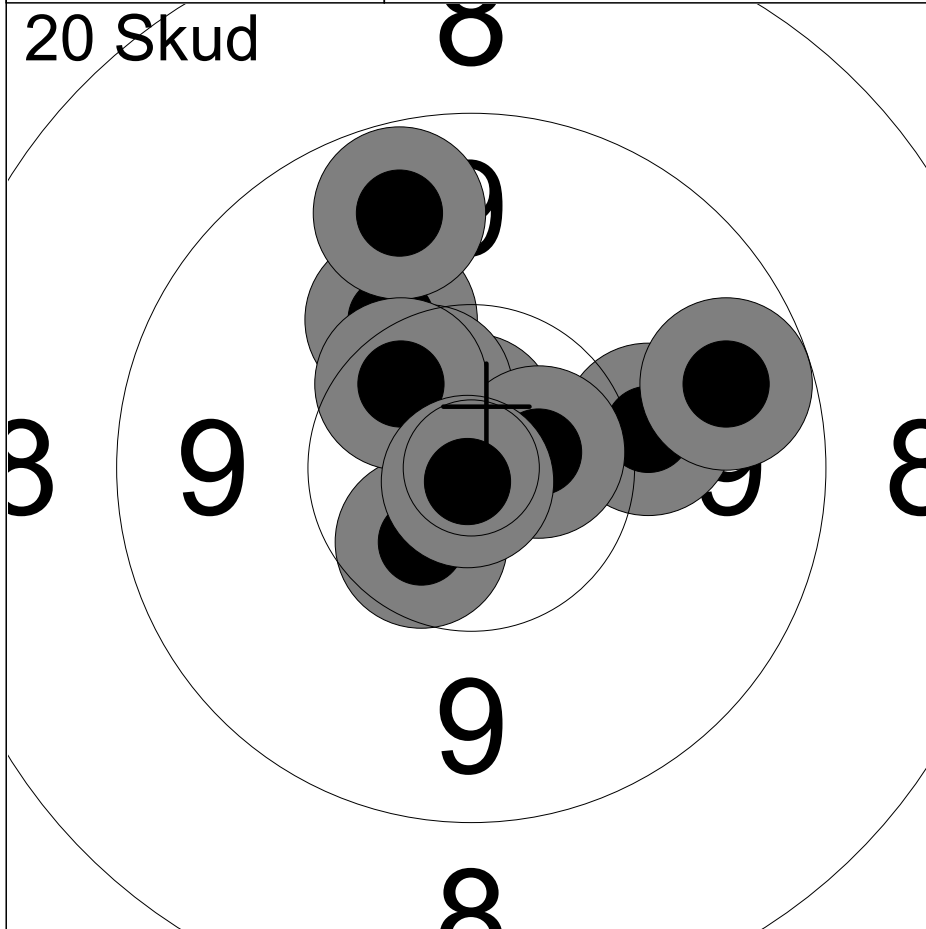

1:	10.1	→
2:	10.7x	↑
3:	10.5x	↙
4:	10.1	↖
5:	9.6	→
6:	9.6	↑
7:	10.5x	↖
8:	10.6x	→
9:	10.4x	↖
10:	10.9x	↙
Serie		98 (6x)
Total		98 (6x)

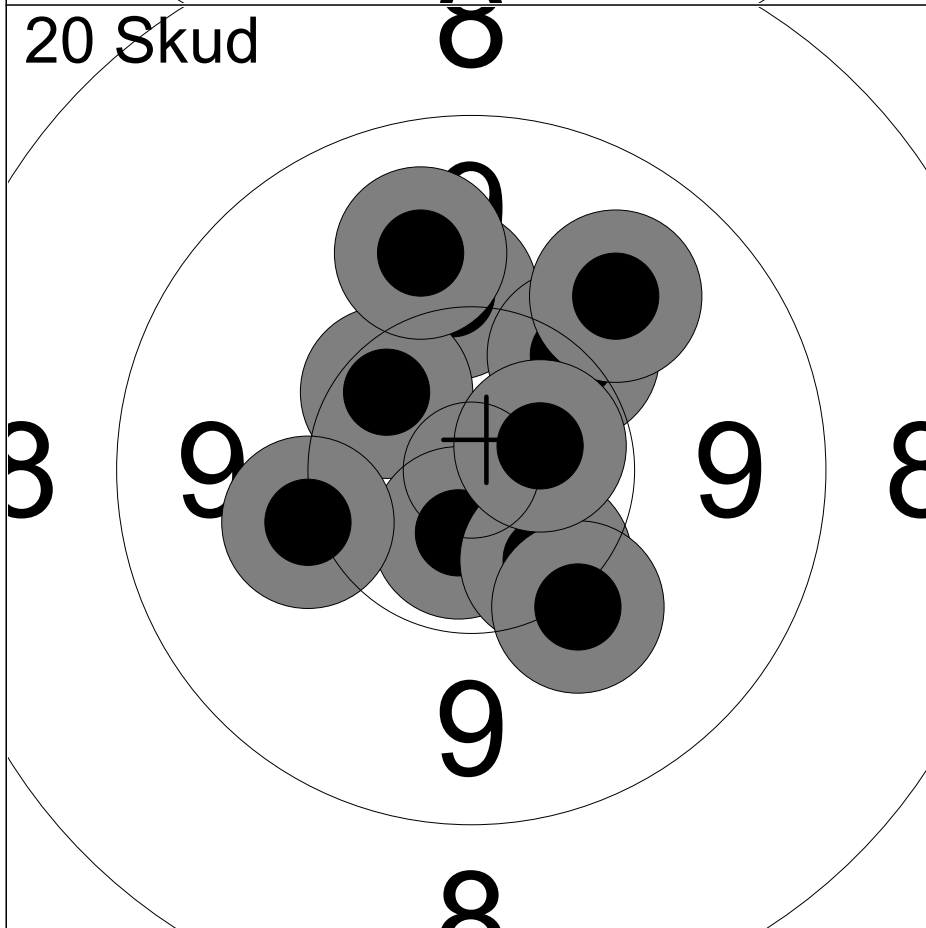

11:	10.1	↑
12:	10.4	↖
13:	10.6x	↙
14:	9.9	↑
15:	10.2	↗
16:	10.4	↙
17:	9.8	↗
18:	10.1	←
19:	10.1	↙
20:	10.6x	→
Serie		98 (2x)
Total		196 (8x)

Hold 26	Skive 8	Cecilie Bugge Deichmann		
50M	Ølstykke Skytteforening		MJ1	
10.08.2024	EM 2024	Hanebjerg Skyttecenter		
Kommentar	Signatur			

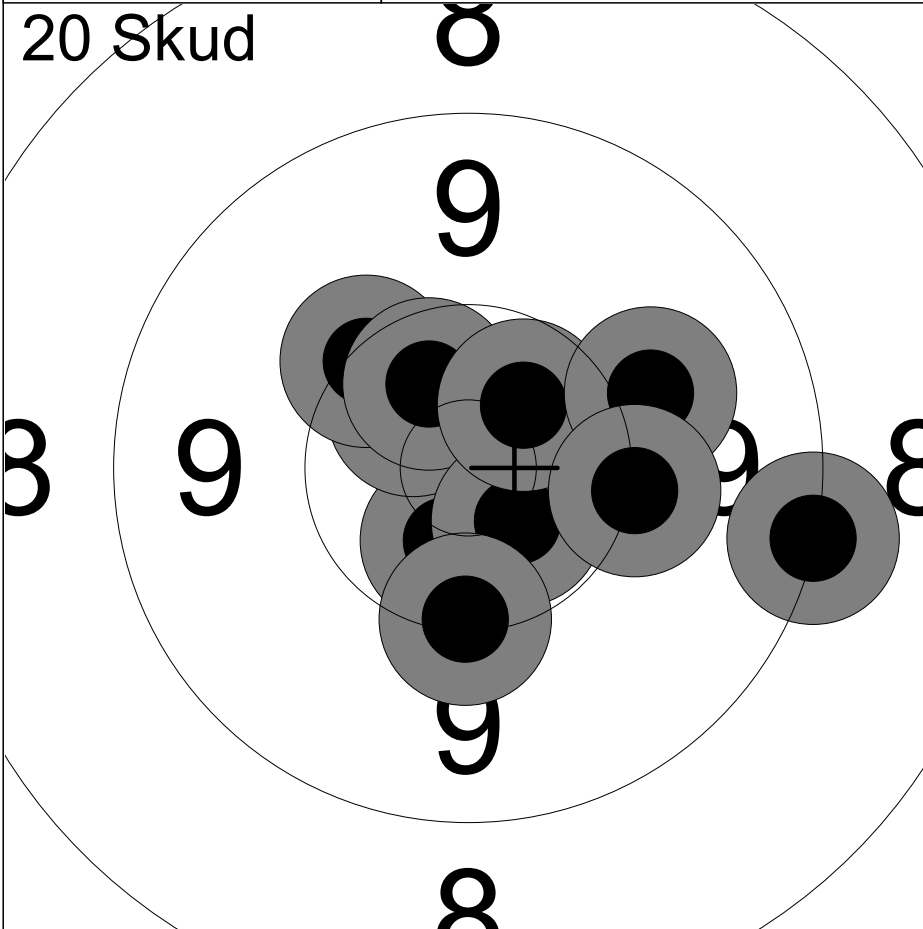

1:	10.6x	↘
2:	10.6x	↗
3:	10.2	↗
4:	10.5x	↗
5:	9.2	→
6:	10.6x	↘
7:	10.5x	↗
8:	10.0	↗
9:	10.1	→
10:	10.2	↓
Serie		99 (5x)
Total		99 (5x)

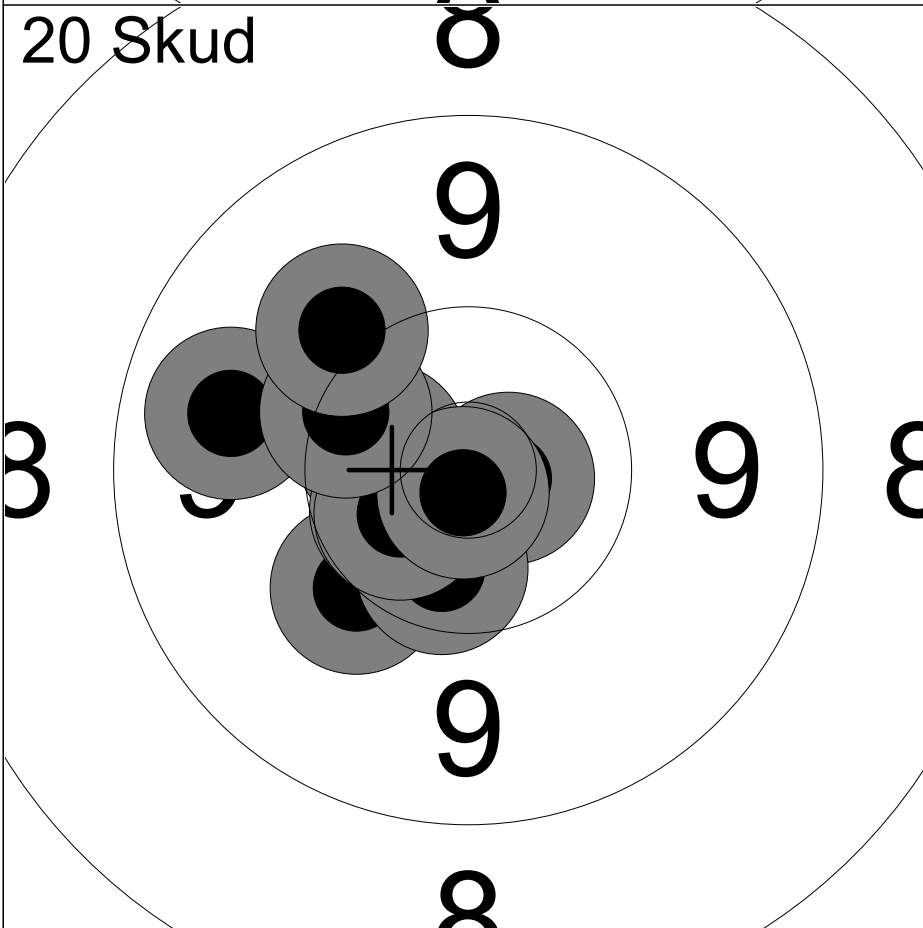

11:	10.8x	→
12:	10.5x	↖
13:	9.8	↖
14:	10.2	↘
15:	10.5x	↘
16:	10.5x	↖
17:	10.6x	↖
18:	10.8x	↘
19:	10.3	↗
20:	10.0	↗
Serie		99 (6x)
Total		198 (11x)

Hold 26	Skive 10	Malou Schmidt-Larsen	
50M		Ølstykke Skytteforening	MJ2
10.08.2024		EM 2024	Hanebjerg Skyttecenter
Kommentar		Signatur	

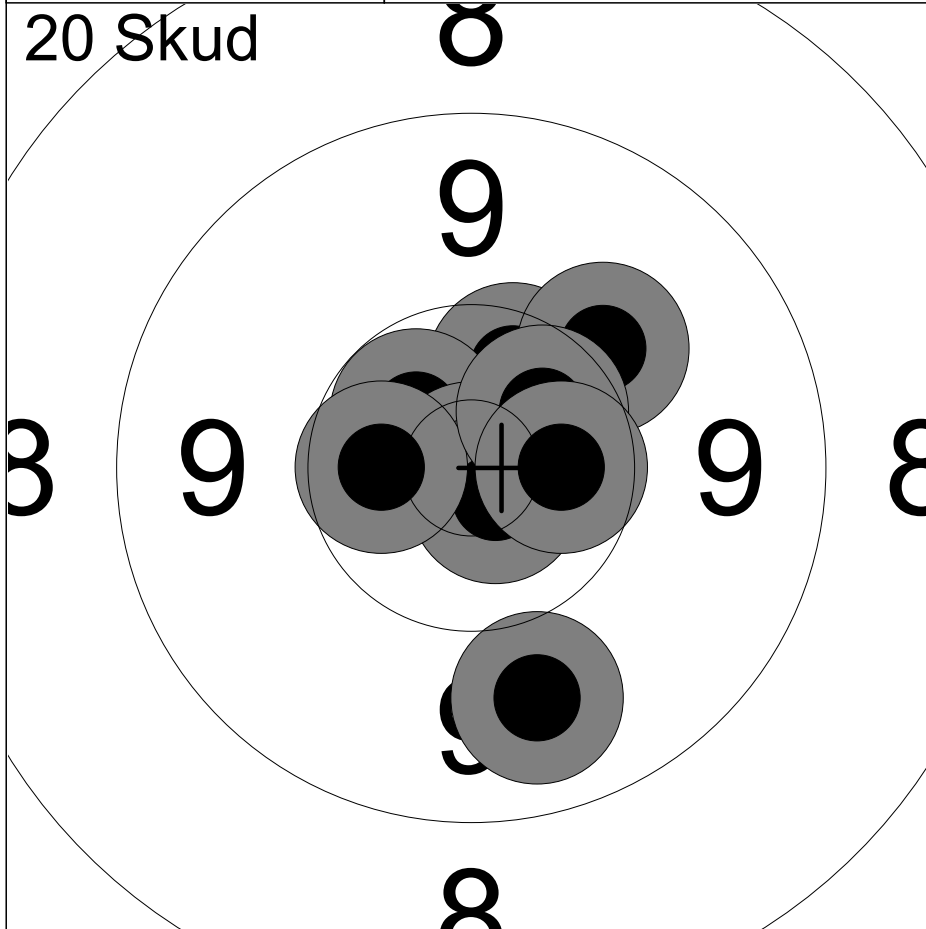

1:	10.6x	↗
2:	10.4x	↗
3:	10.6x	↗
4:	9.8	↘
5:	10.9x	↙
6:	10.1	↗
7:	10.8x	↘
8:	10.5x	←
9:	10.5x	↗
10:	10.5x	→
Serie		99 (8x)
Total		99 (8x)

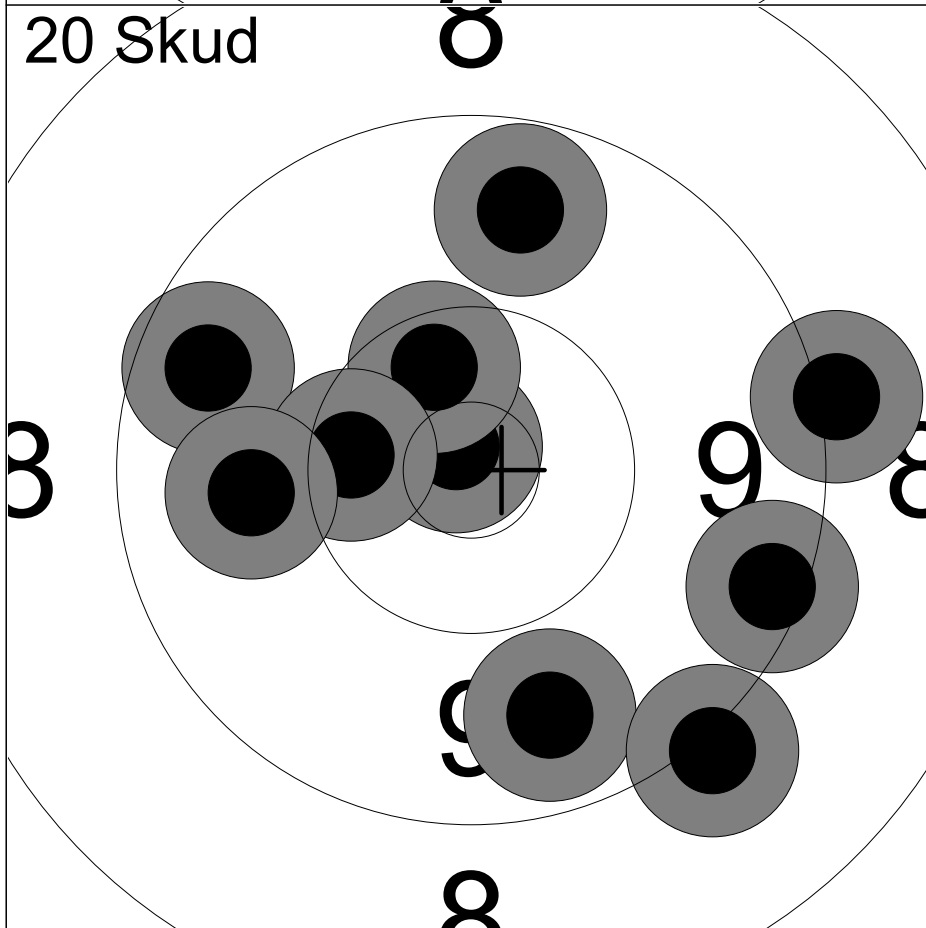

11:	9.7	↘
12:	10.8x	↗
13:	9.6	↙
14:	10.4x	↗
15:	9.6	↗
16:	9.1	→
17:	10.4	←
18:	9.3	↘
19:	9.9	←
20:	9.1	↘
Serie		93 (2x)
Total		192 (10x)

Hold 26	Skive 11	Sara Aaslev Noerager Bay	
50M		Ølstykke Skytteforening	MJ1
10.08.2024		EM 2024	Hanebjerg Skyttecenter
Kommentar		Signatur	

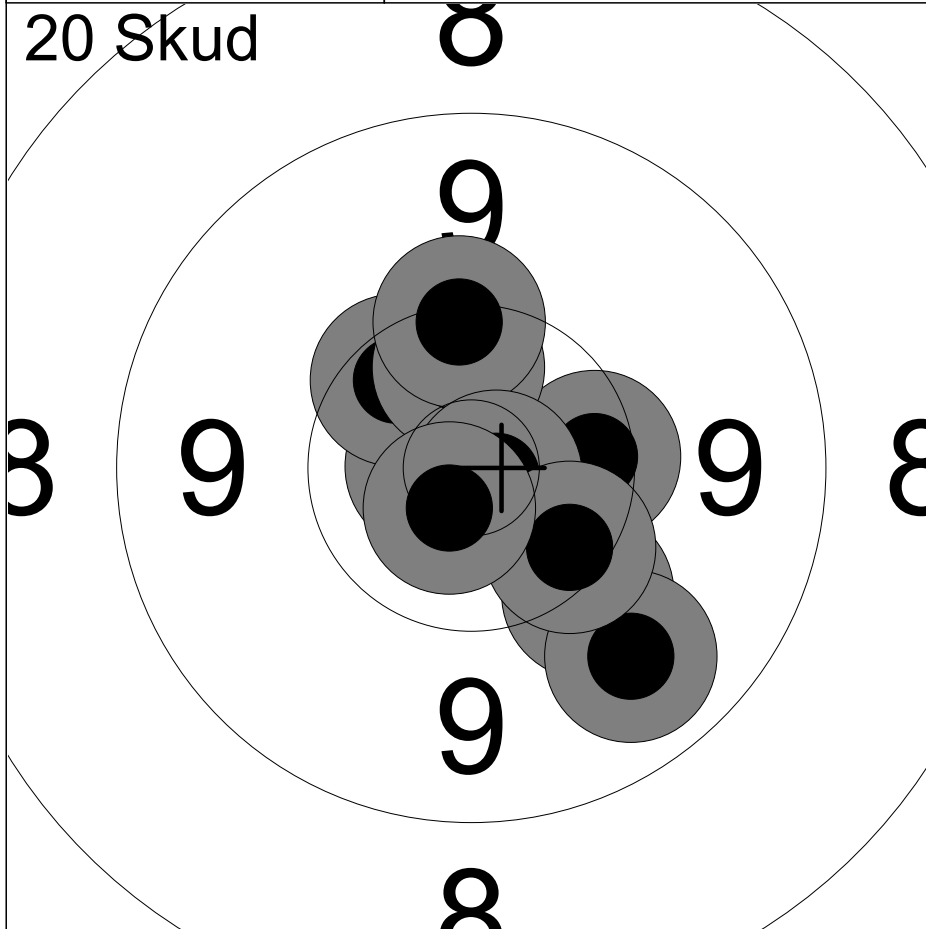

1:	10.3	→
2:	10.8x	←
3:	10.4	↗
4:	10.1	↘
5:	10.5x	↑
6:	10.2	↑
7:	9.7	↘
8:	10.8x	→
9:	10.3	↘
10:	10.7x	↘
Serie		99 (4x)
Total		99 (4x)

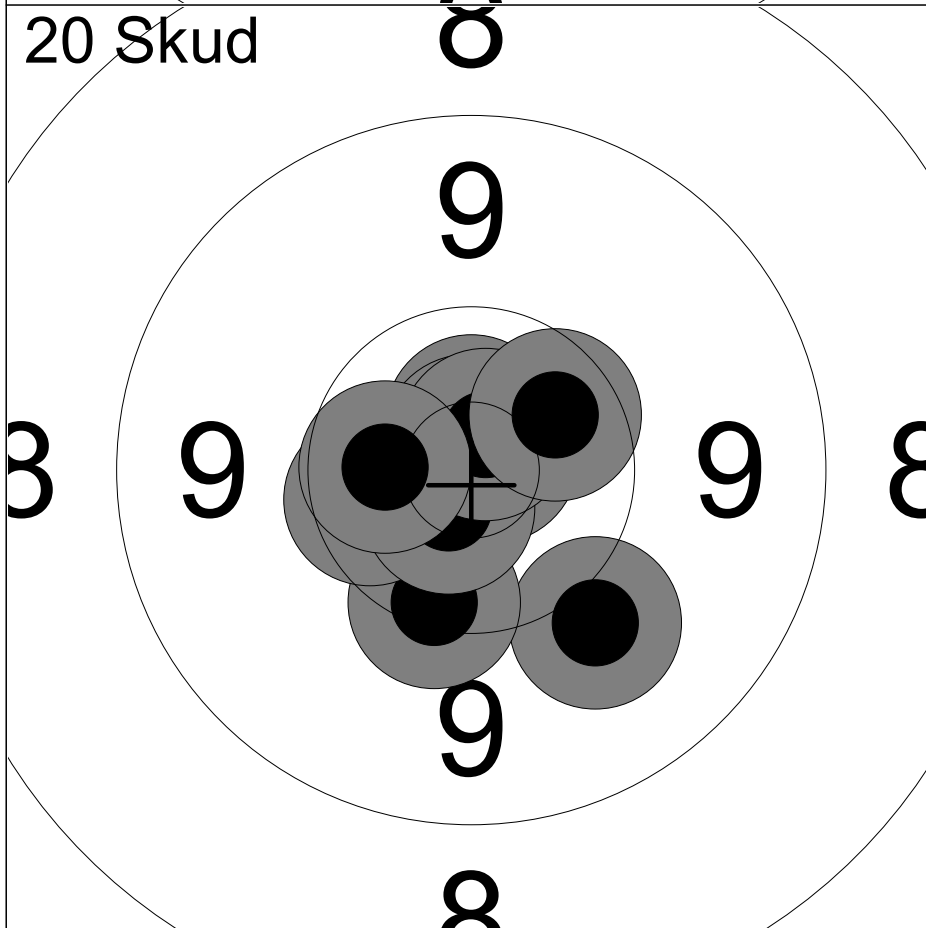

11:	10.8x	↗
12:	10.0	↘
13:	10.3	↘
14:	10.7x	↑
15:	10.4x	←
16:	10.8x	↑
17:	10.7x	↘
18:	10.8x	↗
19:	10.5x	←
20:	10.5x	↗
Serie		100 (8x)
Total		199 (12x)

Hold 26	Skive 12	Ida Aaslev Noerager Bay	
50M	Ølstykke Skytteforening	MJ1	
10.08.2024	EM 2024	Hanebjerg Skyttecenter	
Kommentar	Signatur		

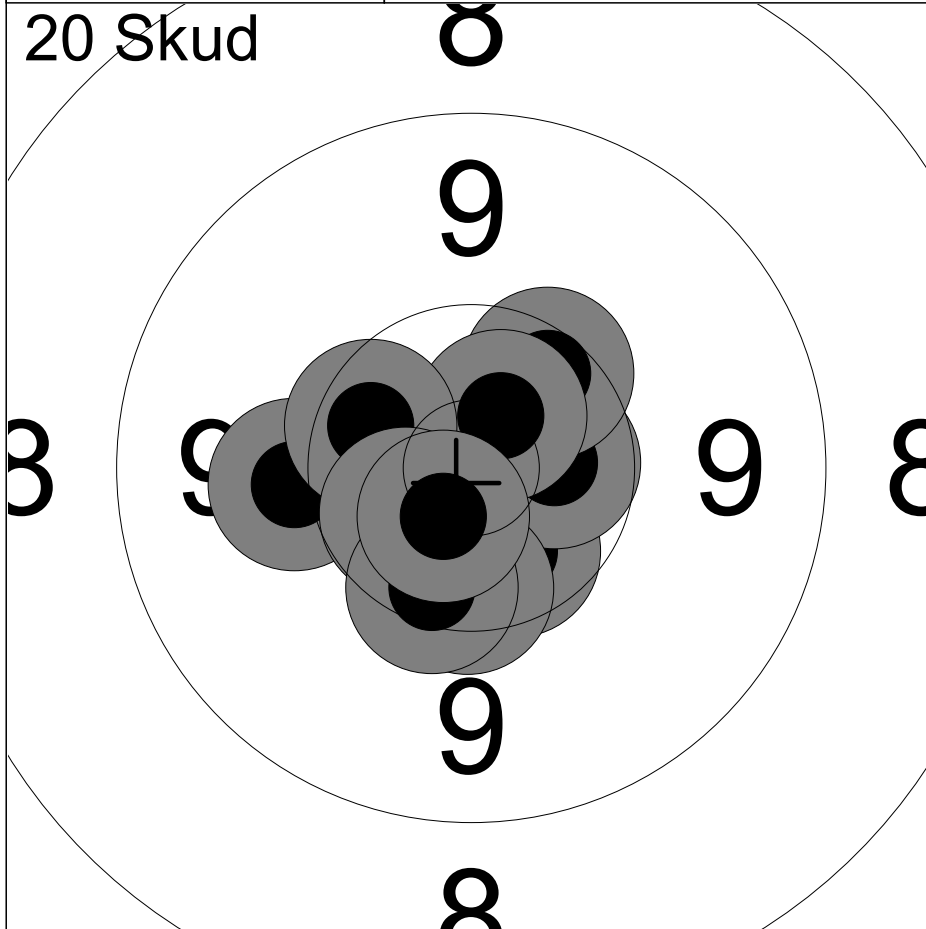









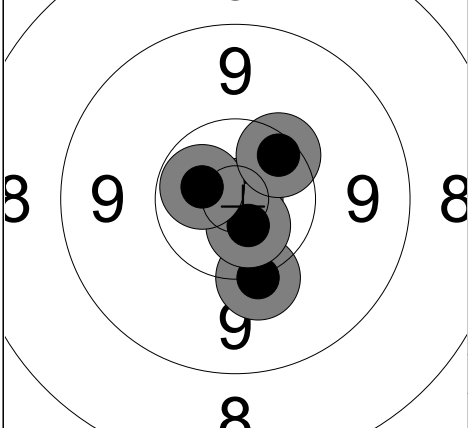

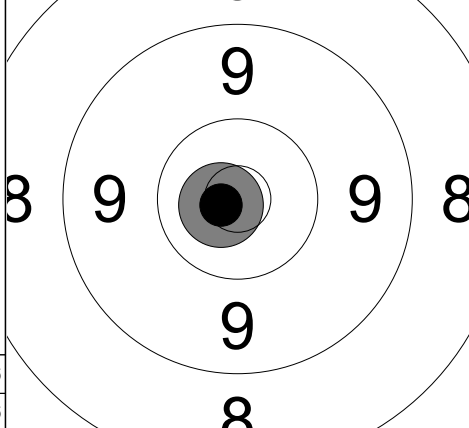

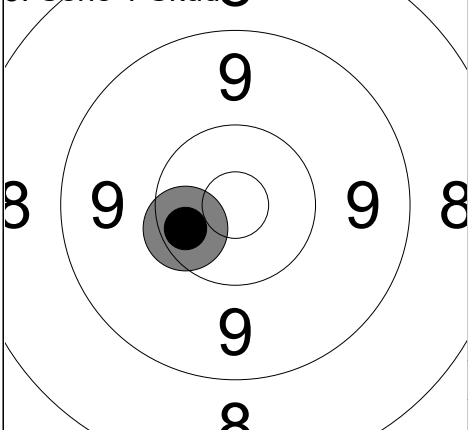

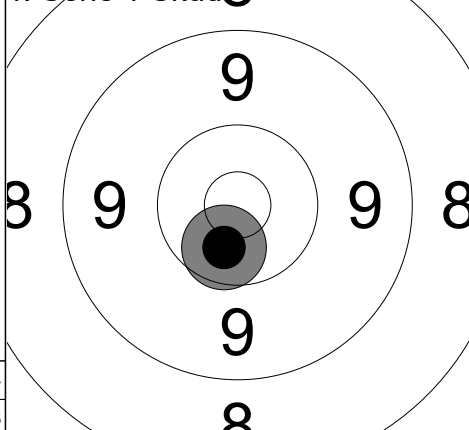
1:	10.1	←
2:	10.5x	↘
3:	10.5x	→
4:	10.4	↗
5:	10.7x	↗
6:	10.4	↘
7:	10.4x	←
8:	10.6x	↙
9:	10.3	↘
10:	10.7x	↙
Serie		100 (6x)
Total		100 (6x)

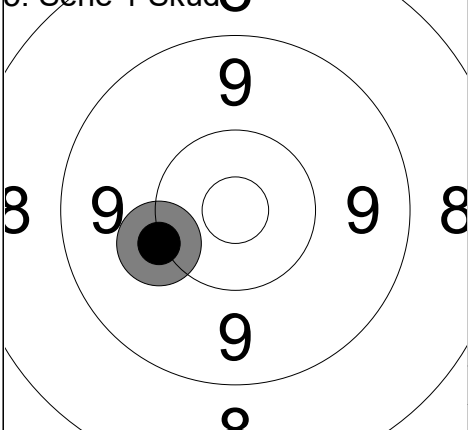

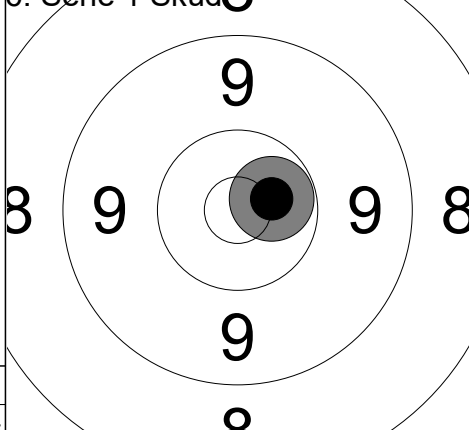
11:	10.6x	↑
12:	10.6x	↖
13:	10.7x	↘
14:	10.8x	→
15:	10.6x	→
16:	10.3	↘
17:	10.4x	↘
18:	10.9x	↙
19:	10.7x	↙
20:	10.4	↑
Serie		100 (8x)
Total		200 (14x)

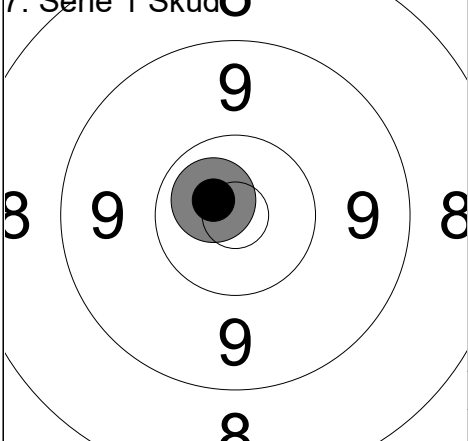
Hold 27	Skive 1	Frederik Lund-Vogensen	
50M		Ganløse Skytteforening	FBK
10.08.2024		EM 2024	Hanebjerg Skyttecenter
Kommentar		Signatur	

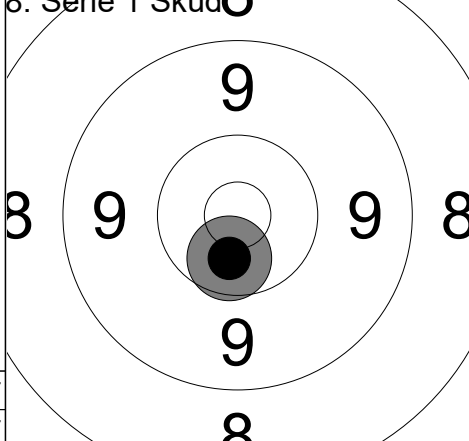
<p>1. Serie 5 Skud </p> 	<p>1: 10.1 ↓ 2: 10.9x → 3: 10.7x ↓ 4: 10.6x ↗ 5: 10.3 ↗</p> <table border="1"> <tr><td>Serie</td><td>52.6</td></tr> <tr><td>Total</td><td>52.6</td></tr> </table>	Serie	52.6	Total	52.6	<p>2. Serie 1 Skud </p> 	<p>1: 10.8x ←</p> <table border="1"> <tr><td>Serie</td><td>10.8</td></tr> <tr><td>Total</td><td>63.4</td></tr> </table>	Serie	10.8	Total	63.4
Serie	52.6										
Total	52.6										
Serie	10.8										
Total	63.4										
<p>3. Serie 1 Skud </p> 	<p>1: 10.4 ←</p> <table border="1"> <tr><td>Serie</td><td>10.4</td></tr> <tr><td>Total</td><td>73.8</td></tr> </table>	Serie	10.4	Total	73.8	<p>4. Serie 1 Skud </p> 	<p>1: 10.5x ↓</p> <table border="1"> <tr><td>Serie</td><td>10.5</td></tr> <tr><td>Total</td><td>84.3</td></tr> </table>	Serie	10.5	Total	84.3
Serie	10.4										
Total	73.8										
Serie	10.5										
Total	84.3										
<p>5. Serie 1 Skud </p> 	<p>1: 10.1 ←</p> <table border="1"> <tr><td>Serie</td><td>10.1</td></tr> <tr><td>Total</td><td>94.4</td></tr> </table>	Serie	10.1	Total	94.4	<p>6. Serie 1 Skud </p> 	<p>1: 10.6x →</p> <table border="1"> <tr><td>Serie</td><td>10.6</td></tr> <tr><td>Total</td><td>105.0</td></tr> </table>	Serie	10.6	Total	105.0
Serie	10.1										
Total	94.4										
Serie	10.6										
Total	105.0										
<p>7. Serie 1 Skud </p> 	<p>1: 10.7x ←</p> <table border="1"> <tr><td>Serie</td><td>10.7</td></tr> <tr><td>Total</td><td>115.7</td></tr> </table>	Serie	10.7	Total	115.7	<p>8. Serie 1 Skud </p> 	<p>1: 10.5x ↓</p> <table border="1"> <tr><td>Serie</td><td>10.5</td></tr> <tr><td>Total</td><td>126.2</td></tr> </table>	Serie	10.5	Total	126.2
Serie	10.7										
Total	115.7										
Serie	10.5										
Total	126.2										

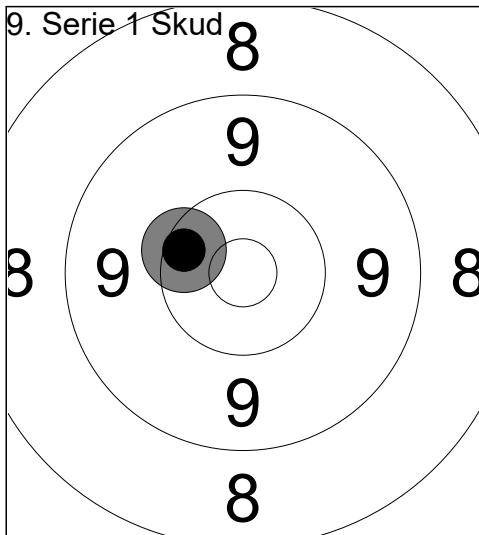

1: 10.3 ←

Serie	10.3
Total	136.5

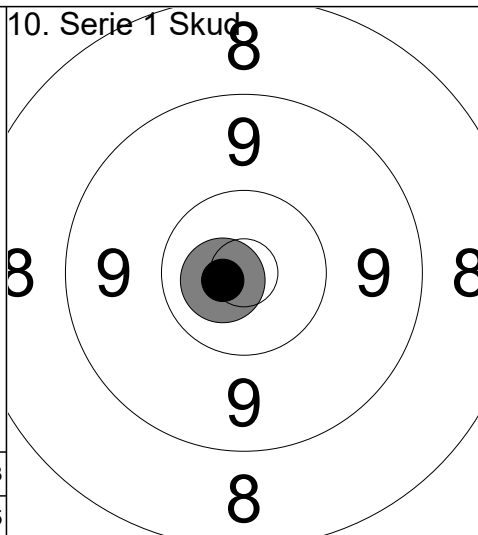

1: 10.7x ←

Serie	10.7
Total	147.2

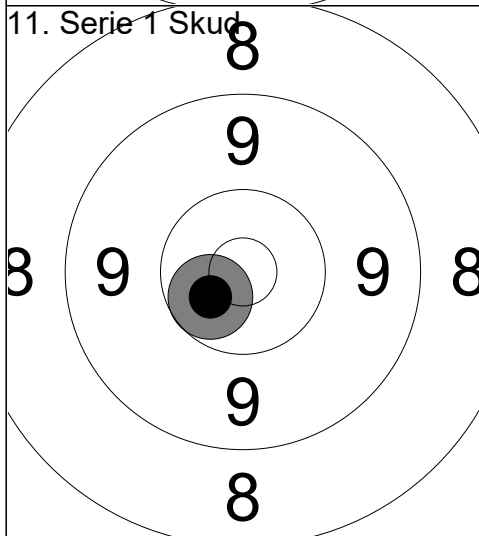

1: 10.6x ↙

Serie	10.6
Total	157.8

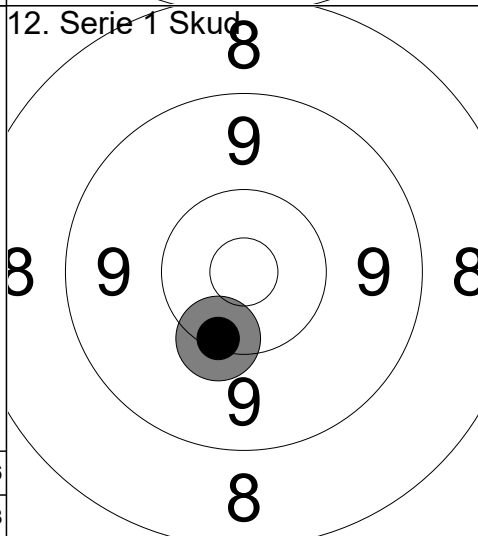

1: 10.3 ↘

Serie	10.3
Total	168.1

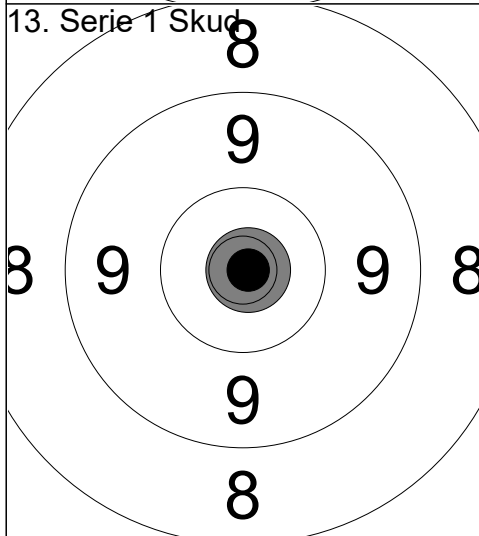

1: 10.9x →

Serie	10.9
Total	179.0

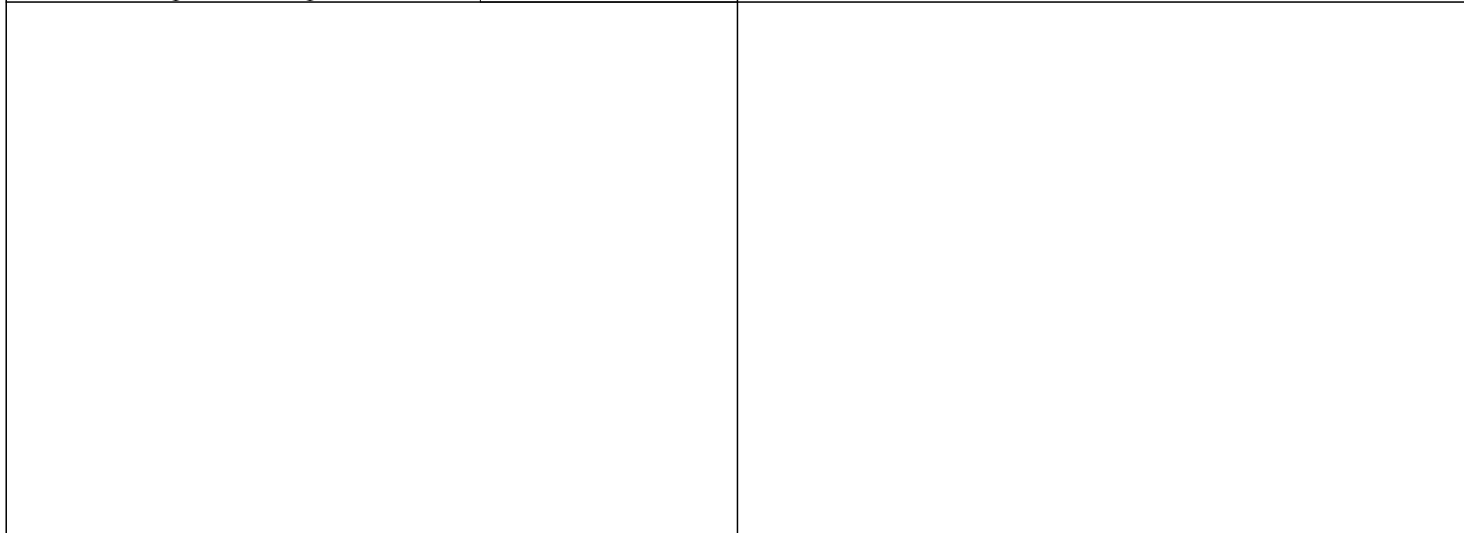

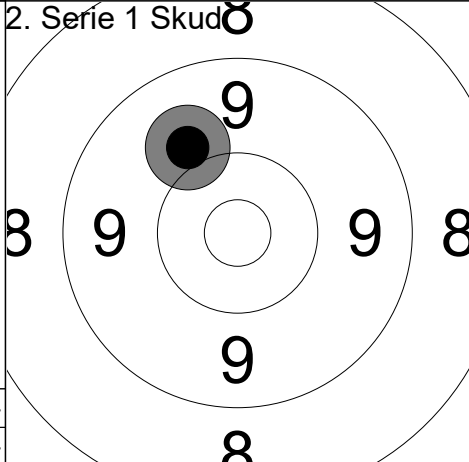
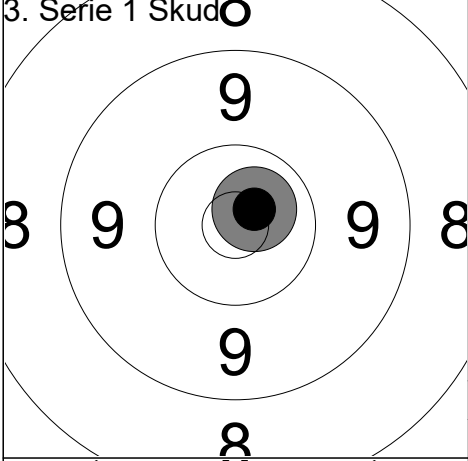
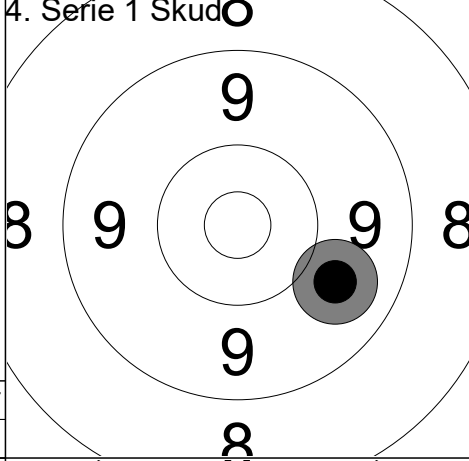
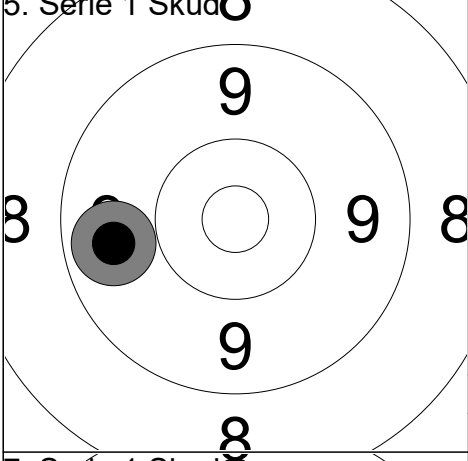
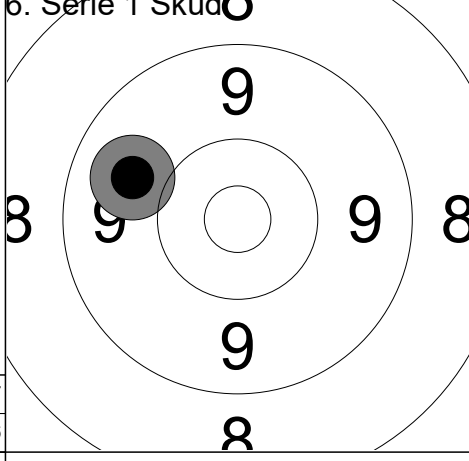
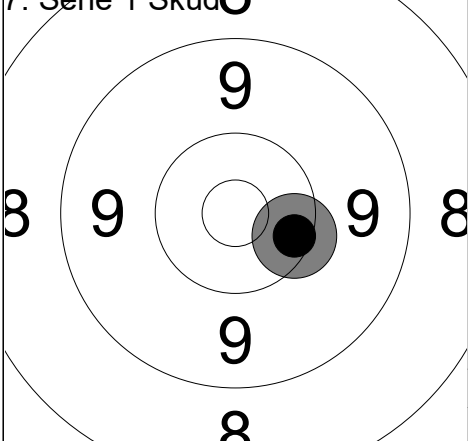
<p>1. Serie 5 Skud </p>  <table border="1" style="width:100%; border-collapse: collapse; margin-top: 10px;"> <tr> <td style="width:50%;">1: 10.6x</td> <td style="width:50%; text-align: right;">↘</td> </tr> <tr> <td>2: 10.8x</td> <td style="text-align: right;">↘</td> </tr> <tr> <td>3: 10.5x</td> <td style="text-align: right;">↙</td> </tr> <tr> <td>4: 10.8x</td> <td style="text-align: right;">↘</td> </tr> <tr> <td>5: 10.7x</td> <td style="text-align: right;">↗</td> </tr> </table> <table border="1" style="width:100%; border-collapse: collapse; margin-top: 10px;"> <tr> <td style="width:50%;">Serie</td> <td style="width:50%; text-align: right;">53.4</td> </tr> <tr> <td>Total</td> <td style="text-align: right;">53.4</td> </tr> </table>	1: 10.6x	↘	2: 10.8x	↘	3: 10.5x	↙	4: 10.8x	↘	5: 10.7x	↗	Serie	53.4	Total	53.4	<p>2. Serie 1 Skud </p>  <table border="1" style="width:100%; border-collapse: collapse; margin-top: 10px;"> <tr> <td style="width:50%;">1: 10.0</td> <td style="width:50%; text-align: right;">↖</td> </tr> </table> <table border="1" style="width:100%; border-collapse: collapse; margin-top: 10px;"> <tr> <td style="width:50%;">Serie</td> <td style="width:50%; text-align: right;">10.0</td> </tr> <tr> <td>Total</td> <td style="text-align: right;">63.4</td> </tr> </table>	1: 10.0	↖	Serie	10.0	Total	63.4															
1: 10.6x	↘																																			
2: 10.8x	↘																																			
3: 10.5x	↙																																			
4: 10.8x	↘																																			
5: 10.7x	↗																																			
Serie	53.4																																			
Total	53.4																																			
1: 10.0	↖																																			
Serie	10.0																																			
Total	63.4																																			
<p>3. Serie 1 Skud </p>  <table border="1" style="width:100%; border-collapse: collapse; margin-top: 10px;"> <tr> <td style="width:50%;">1: 10.7x</td> <td style="width:50%; text-align: right;">↗</td> </tr> </table> <table border="1" style="width:100%; border-collapse: collapse; margin-top: 10px;"> <tr> <td style="width:50%;">Serie</td> <td style="width:50%; text-align: right;">10.7</td> </tr> <tr> <td>Total</td> <td style="text-align: right;">74.1</td> </tr> </table>	1: 10.7x	↗	Serie	10.7	Total	74.1	<p>4. Serie 1 Skud </p>  <table border="1" style="width:100%; border-collapse: collapse; margin-top: 10px;"> <tr> <td style="width:50%;">1: 9.8</td> <td style="width:50%; text-align: right;">↘</td> </tr> </table> <table border="1" style="width:100%; border-collapse: collapse; margin-top: 10px;"> <tr> <td style="width:50%;">Serie</td> <td style="width:50%; text-align: right;">9.8</td> </tr> <tr> <td>Total</td> <td style="text-align: right;">83.9</td> </tr> </table>	1: 9.8	↘	Serie	9.8	Total	83.9	<p>5. Serie 1 Skud </p>  <table border="1" style="width:100%; border-collapse: collapse; margin-top: 10px;"> <tr> <td style="width:50%;">1: 9.7</td> <td style="width:50%; text-align: right;">←</td> </tr> </table> <table border="1" style="width:100%; border-collapse: collapse; margin-top: 10px;"> <tr> <td style="width:50%;">Serie</td> <td style="width:50%; text-align: right;">9.7</td> </tr> <tr> <td>Total</td> <td style="text-align: right;">93.6</td> </tr> </table>	1: 9.7	←	Serie	9.7	Total	93.6	<p>6. Serie 1 Skud </p>  <table border="1" style="width:100%; border-collapse: collapse; margin-top: 10px;"> <tr> <td style="width:50%;">1: 9.8</td> <td style="width:50%; text-align: right;">←</td> </tr> </table> <table border="1" style="width:100%; border-collapse: collapse; margin-top: 10px;"> <tr> <td style="width:50%;">Serie</td> <td style="width:50%; text-align: right;">9.8</td> </tr> <tr> <td>Total</td> <td style="text-align: right;">103.4</td> </tr> </table>	1: 9.8	←	Serie	9.8	Total	103.4	<p>7. Serie 1 Skud </p>  <table border="1" style="width:100%; border-collapse: collapse; margin-top: 10px;"> <tr> <td style="width:50%;">1: 10.3</td> <td style="width:50%; text-align: right;">→</td> </tr> </table> <table border="1" style="width:100%; border-collapse: collapse; margin-top: 10px;"> <tr> <td style="width:50%;">Serie</td> <td style="width:50%; text-align: right;">10.3</td> </tr> <tr> <td>Total</td> <td style="text-align: right;">113.7</td> </tr> </table>	1: 10.3	→	Serie	10.3	Total	113.7		
1: 10.7x	↗																																			
Serie	10.7																																			
Total	74.1																																			
1: 9.8	↘																																			
Serie	9.8																																			
Total	83.9																																			
1: 9.7	←																																			
Serie	9.7																																			
Total	93.6																																			
1: 9.8	←																																			
Serie	9.8																																			
Total	103.4																																			
1: 10.3	→																																			
Serie	10.3																																			
Total	113.7																																			

Hold 27	Skive 3	Noah Misfeldt Kvist-Andersen	
50M	Ganløse Skytteforening	FBK	
10.08.2024	EM 2024	Hanebjerg Skyttecenter	
Kommentar	Signatur		

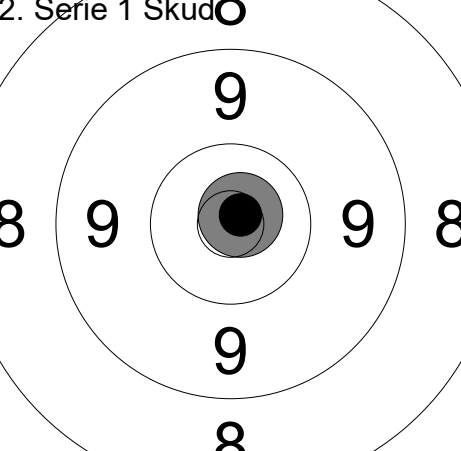
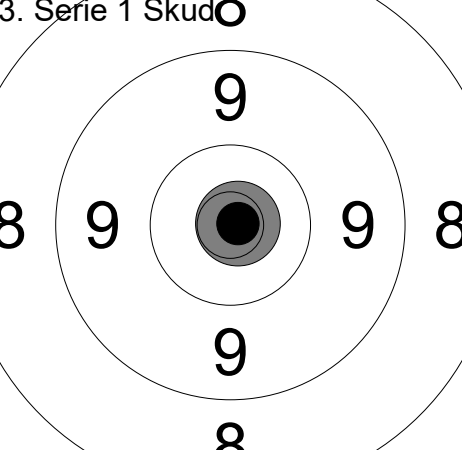
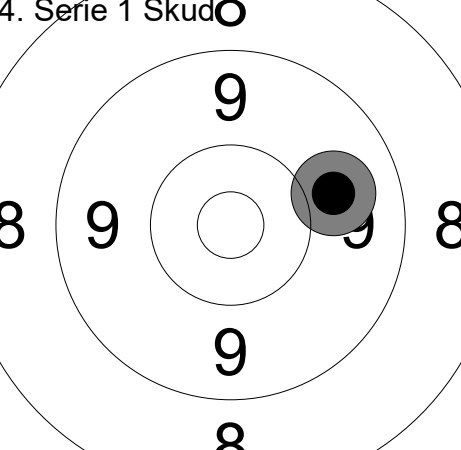
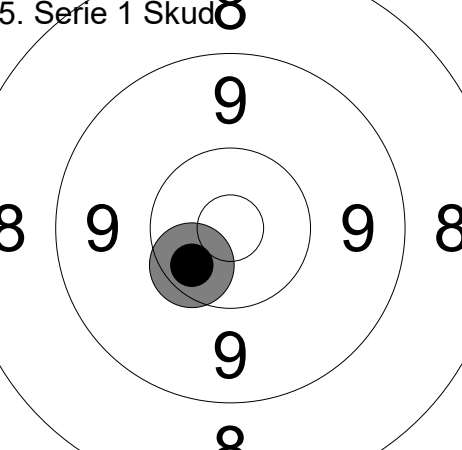
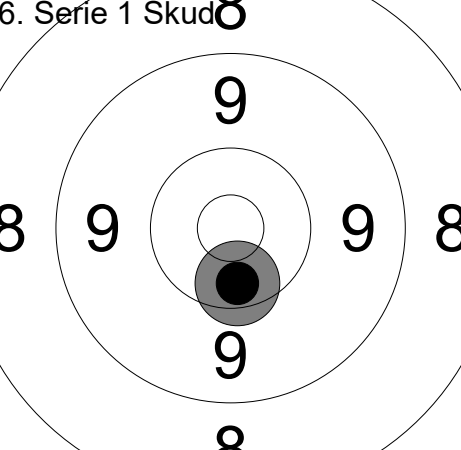
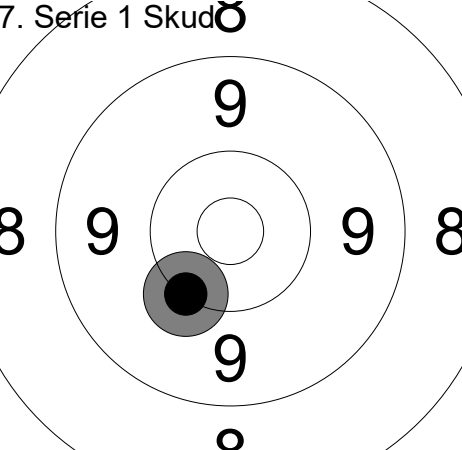
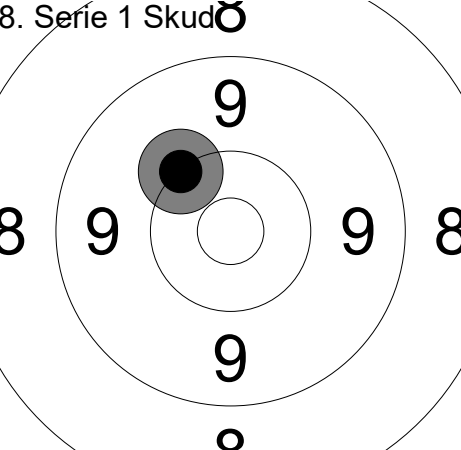
1. Serie 5 Skud 	1: 10.7x ↖ 2: 10.6x ↓ 3: 10.5x ↖ 4: 10.3x ↘ 5: 10.9x ↗	2. Serie 1 Skud 	1: 10.8x ↗								
<table border="1"> <tr><td>Serie</td><td>53.0</td></tr> <tr><td>Total</td><td>53.0</td></tr> </table>	Serie	53.0	Total	53.0		<table border="1"> <tr><td>Serie</td><td>10.8</td></tr> <tr><td>Total</td><td>63.8</td></tr> </table>	Serie	10.8	Total	63.8	
Serie	53.0										
Total	53.0										
Serie	10.8										
Total	63.8										
3. Serie 1 Skud 	1: 10.9x →	4. Serie 1 Skud 	1: 9.9 →								
<table border="1"> <tr><td>Serie</td><td>10.9</td></tr> <tr><td>Total</td><td>74.7</td></tr> </table>	Serie	10.9	Total	74.7		<table border="1"> <tr><td>Serie</td><td>9.9</td></tr> <tr><td>Total</td><td>84.6</td></tr> </table>	Serie	9.9	Total	84.6	
Serie	10.9										
Total	74.7										
Serie	9.9										
Total	84.6										
5. Serie 1 Skud 	1: 10.4x ↖	6. Serie 1 Skud 	1: 10.4 ↓								
<table border="1"> <tr><td>Serie</td><td>10.4</td></tr> <tr><td>Total</td><td>95.0</td></tr> </table>	Serie	10.4	Total	95.0		<table border="1"> <tr><td>Serie</td><td>10.4</td></tr> <tr><td>Total</td><td>105.4</td></tr> </table>	Serie	10.4	Total	105.4	
Serie	10.4										
Total	95.0										
Serie	10.4										
Total	105.4										
7. Serie 1 Skud 	1: 10.2 ↘	8. Serie 1 Skud 	1: 10.2 ↖								
<table border="1"> <tr><td>Serie</td><td>10.2</td></tr> <tr><td>Total</td><td>115.6</td></tr> </table>	Serie	10.2	Total	115.6		<table border="1"> <tr><td>Serie</td><td>10.2</td></tr> <tr><td>Total</td><td>125.8</td></tr> </table>	Serie	10.2	Total	125.8	
Serie	10.2										
Total	115.6										
Serie	10.2										
Total	125.8										

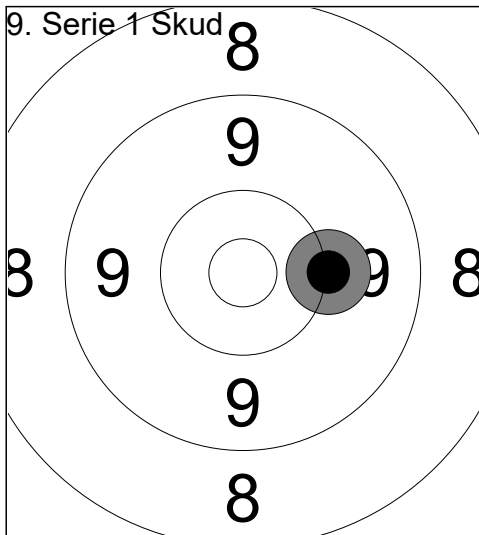

1: 10.1 →

Serie	10.1
Total	135.9

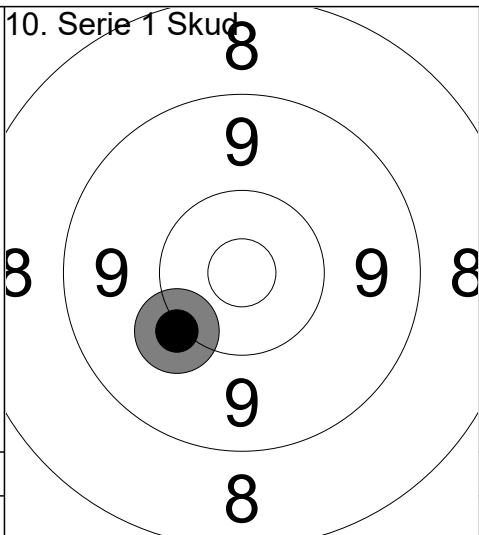

1: 10.1 ↙

Serie	10.1
Total	146.0

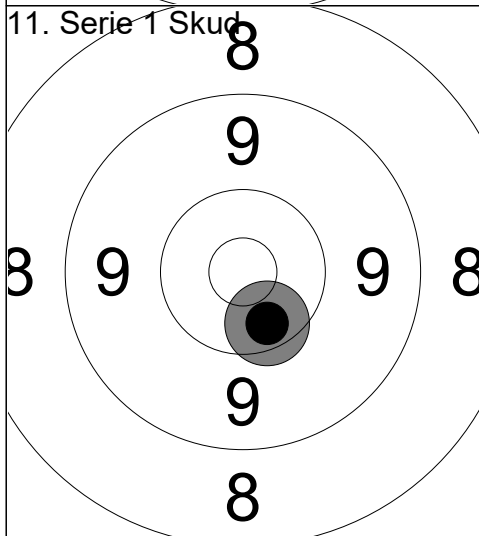

1: 10.4 ↘

Serie	10.4
Total	156.4

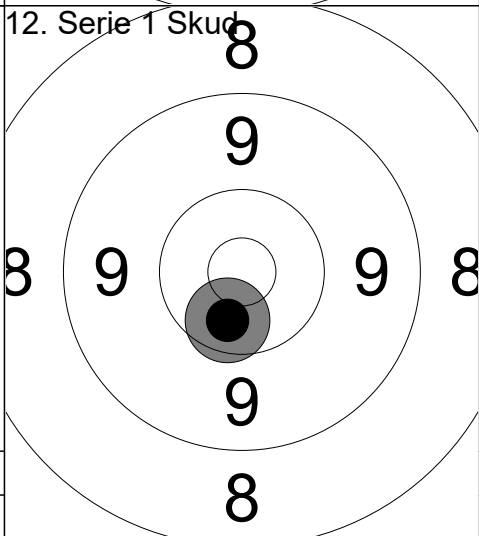

1: 10.5x ↘

Serie	10.5
Total	166.9

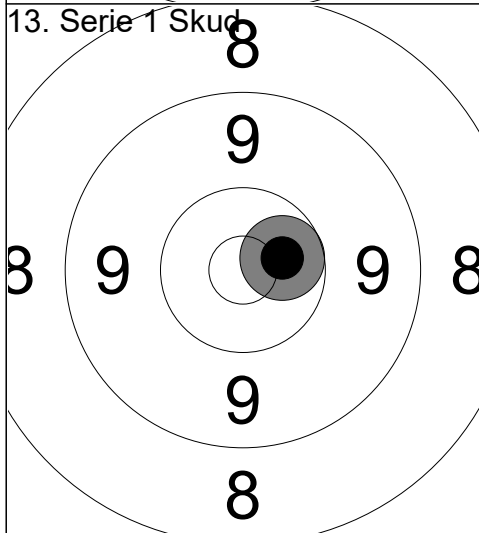

1: 10.6x →

Serie	10.6
Total	177.5

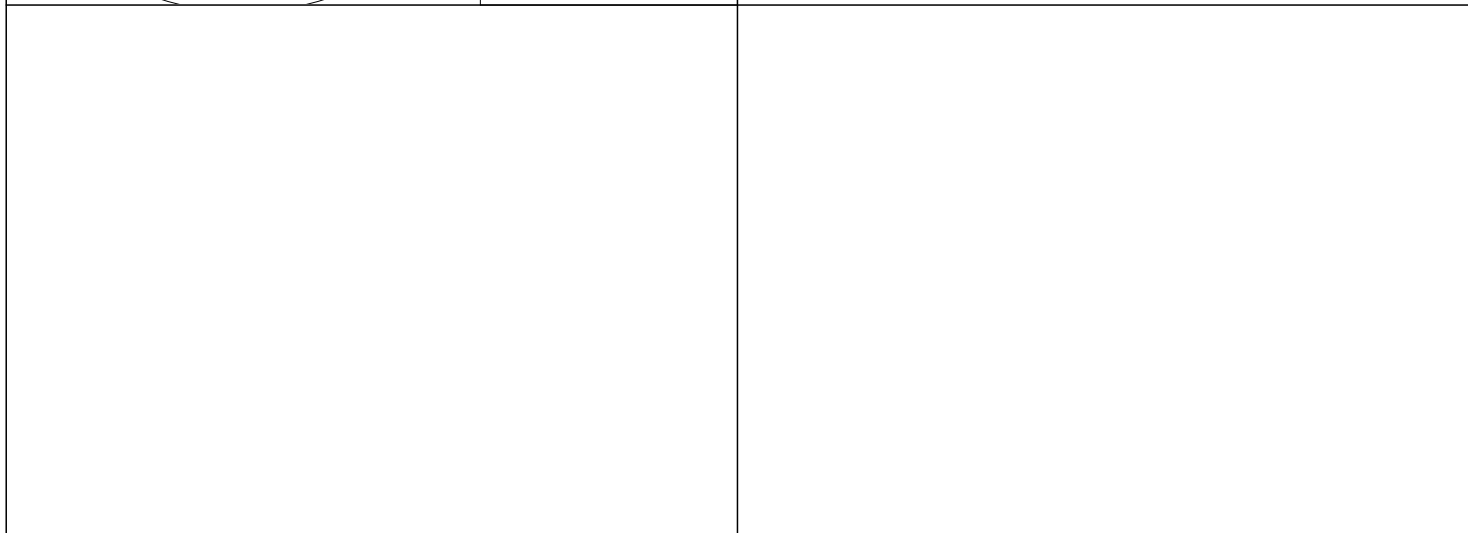

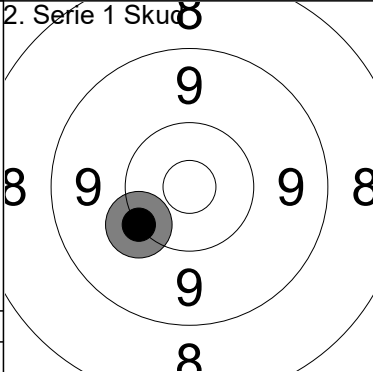
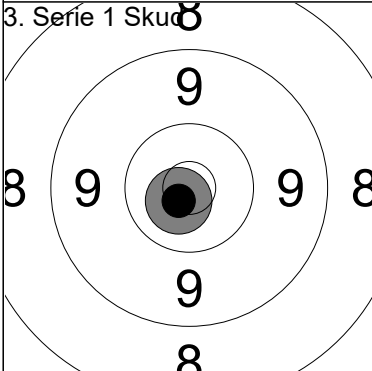
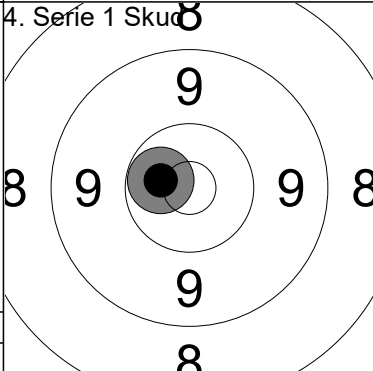
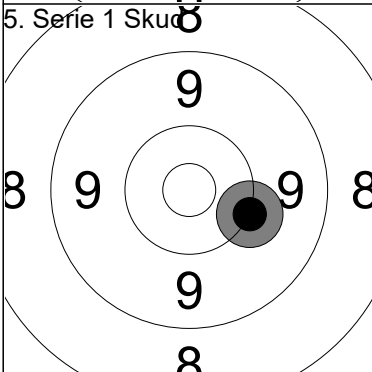
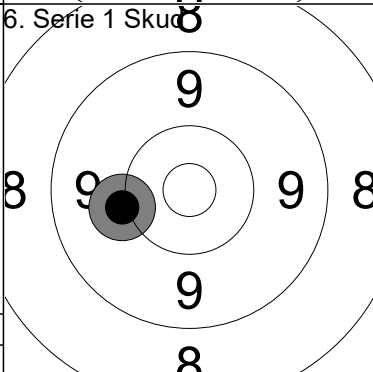
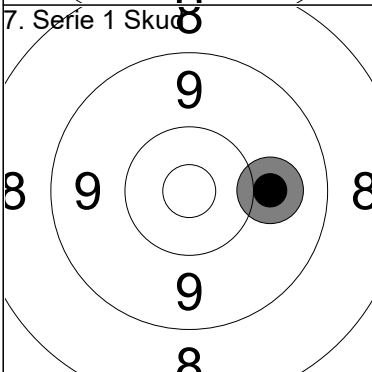
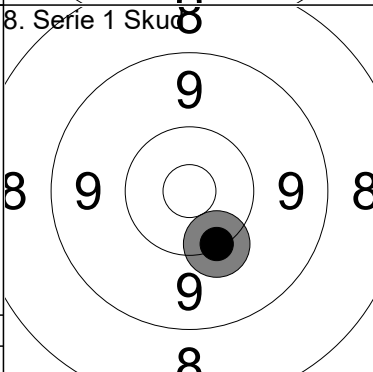
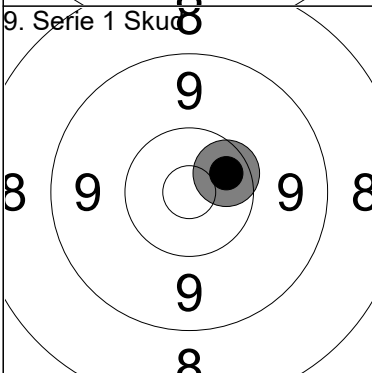
<p>1. Serie 5 Skud </p>	<p>1: 10.8x ↙ 2: 10.6x ↓ 3: 10.3 ↑ 4: 10.5x ↗ 5: 10.1 →</p> <table border="1" style="width:100%; border-collapse: collapse;"> <tr><td>Serie</td><td style="text-align: right;">52.3</td></tr> <tr><td>Total</td><td style="text-align: right;">52.3</td></tr> </table>	Serie	52.3	Total	52.3	<p>2. Serie 1 Skud </p>	<p>1: 10.2 ↙</p> <table border="1" style="width:100%; border-collapse: collapse;"> <tr><td>Serie</td><td style="text-align: right;">10.2</td></tr> <tr><td>Total</td><td style="text-align: right;">62.5</td></tr> </table>	Serie	10.2	Total	62.5
Serie	52.3										
Total	52.3										
Serie	10.2										
Total	62.5										
<p>3. Serie 1 Skud </p>	<p>1: 10.7x ↙</p> <table border="1" style="width:100%; border-collapse: collapse;"> <tr><td>Serie</td><td style="text-align: right;">10.7</td></tr> <tr><td>Total</td><td style="text-align: right;">73.2</td></tr> </table>	Serie	10.7	Total	73.2	<p>4. Serie 1 Skud </p>	<p>1: 10.6x ←</p> <table border="1" style="width:100%; border-collapse: collapse;"> <tr><td>Serie</td><td style="text-align: right;">10.6</td></tr> <tr><td>Total</td><td style="text-align: right;">83.8</td></tr> </table>	Serie	10.6	Total	83.8
Serie	10.7										
Total	73.2										
Serie	10.6										
Total	83.8										
<p>5. Serie 1 Skud </p>	<p>1: 10.1 →</p> <table border="1" style="width:100%; border-collapse: collapse;"> <tr><td>Serie</td><td style="text-align: right;">10.1</td></tr> <tr><td>Total</td><td style="text-align: right;">93.9</td></tr> </table>	Serie	10.1	Total	93.9	<p>6. Serie 1 Skud </p>	<p>1: 10.1 ←</p> <table border="1" style="width:100%; border-collapse: collapse;"> <tr><td>Serie</td><td style="text-align: right;">10.1</td></tr> <tr><td>Total</td><td style="text-align: right;">104.0</td></tr> </table>	Serie	10.1	Total	104.0
Serie	10.1										
Total	93.9										
Serie	10.1										
Total	104.0										
<p>7. Serie 1 Skud </p>	<p>1: 9.9 →</p> <table border="1" style="width:100%; border-collapse: collapse;"> <tr><td>Serie</td><td style="text-align: right;">9.9</td></tr> <tr><td>Total</td><td style="text-align: right;">113.9</td></tr> </table>	Serie	9.9	Total	113.9	<p>8. Serie 1 Skud </p>	<p>1: 10.2 ↓</p> <table border="1" style="width:100%; border-collapse: collapse;"> <tr><td>Serie</td><td style="text-align: right;">10.2</td></tr> <tr><td>Total</td><td style="text-align: right;">124.1</td></tr> </table>	Serie	10.2	Total	124.1
Serie	9.9										
Total	113.9										
Serie	10.2										
Total	124.1										
<p>9. Serie 1 Skud </p>	<p>1: 10.4x ↗</p> <table border="1" style="width:100%; border-collapse: collapse;"> <tr><td>Serie</td><td style="text-align: right;">10.4</td></tr> <tr><td>Total</td><td style="text-align: right;">134.5</td></tr> </table>	Serie	10.4	Total	134.5						
Serie	10.4										
Total	134.5										

Hold 27	Skive 5	William Moelbak		
50M	Frederikssund Skytteforening, I		FBK	
10.08.2024	EM 2024	Hanebjerg Skyttecenter		
Kommentar	Signatur			

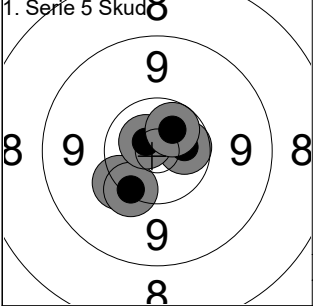
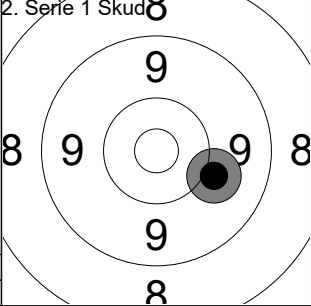
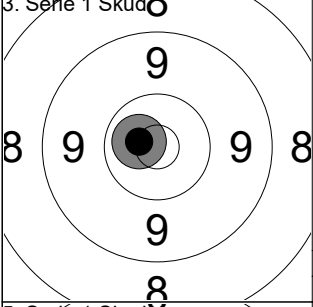
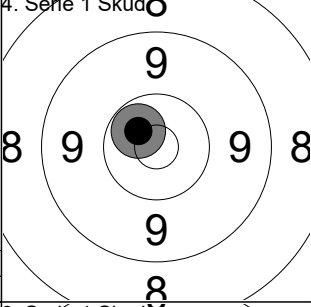
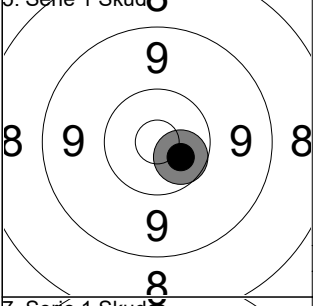
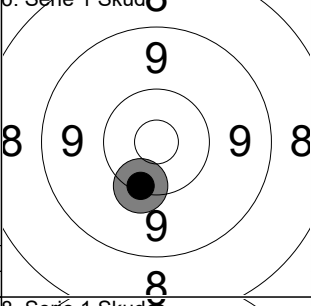
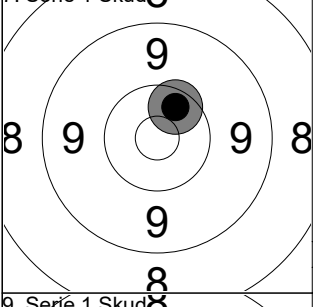
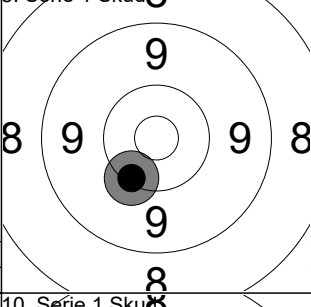
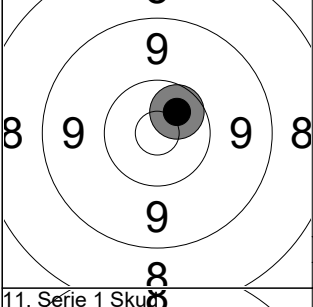
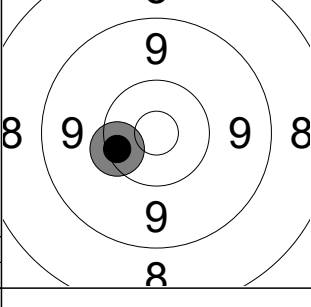
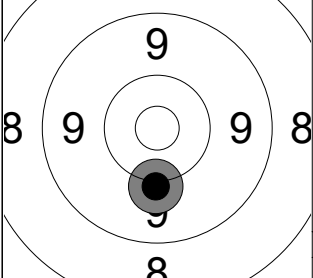
1. Serie 5 Skud 	1: 10.2 2: 10.3 3: 10.5x 4: 10.7x 5: 10.6x	2. Serie 1 Skud 	1: 10.0								
<table border="1"><tr><td>Serie</td><td>52.3</td></tr><tr><td>Total</td><td>52.3</td></tr></table>	Serie	52.3	Total	52.3		<table border="1"><tr><td>Serie</td><td>10.0</td></tr><tr><td>Total</td><td>62.3</td></tr></table>	Serie	10.0	Total	62.3	
Serie	52.3										
Total	52.3										
Serie	10.0										
Total	62.3										
3. Serie 1 Skud 	1: 10.7x	4. Serie 1 Skud 	1: 10.6x								
<table border="1"><tr><td>Serie</td><td>10.7</td></tr><tr><td>Total</td><td>73.0</td></tr></table>	Serie	10.7	Total	73.0		<table border="1"><tr><td>Serie</td><td>10.6</td></tr><tr><td>Total</td><td>83.6</td></tr></table>	Serie	10.6	Total	83.6	
Serie	10.7										
Total	73.0										
Serie	10.6										
Total	83.6										
5. Serie 1 Skud 	1: 10.5x	6. Serie 1 Skud 	1: 10.3								
<table border="1"><tr><td>Serie</td><td>10.5</td></tr><tr><td>Total</td><td>94.1</td></tr></table>	Serie	10.5	Total	94.1		<table border="1"><tr><td>Serie</td><td>10.3</td></tr><tr><td>Total</td><td>104.4</td></tr></table>	Serie	10.3	Total	104.4	
Serie	10.5										
Total	94.1										
Serie	10.3										
Total	104.4										
7. Serie 1 Skud 	1: 10.4x	8. Serie 1 Skud 	1: 10.2								
<table border="1"><tr><td>Serie</td><td>10.4</td></tr><tr><td>Total</td><td>114.8</td></tr></table>	Serie	10.4	Total	114.8		<table border="1"><tr><td>Serie</td><td>10.2</td></tr><tr><td>Total</td><td>125.0</td></tr></table>	Serie	10.2	Total	125.0	
Serie	10.4										
Total	114.8										
Serie	10.2										
Total	125.0										
9. Serie 1 Skud 	1: 10.5x	10. Serie 1 Skud 	1: 10.3								
<table border="1"><tr><td>Serie</td><td>10.5</td></tr><tr><td>Total</td><td>135.5</td></tr></table>	Serie	10.5	Total	135.5		<table border="1"><tr><td>Serie</td><td>10.3</td></tr><tr><td>Total</td><td>145.8</td></tr></table>	Serie	10.3	Total	145.8	
Serie	10.5										
Total	135.5										
Serie	10.3										
Total	145.8										
11. Serie 1 Skud 	1: 10.1										
<table border="1"><tr><td>Serie</td><td>10.1</td></tr><tr><td>Total</td><td>155.9</td></tr></table>	Serie	10.1	Total	155.9							
Serie	10.1										
Total	155.9										

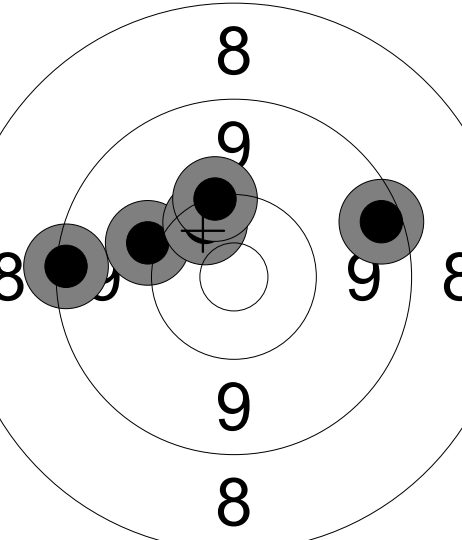
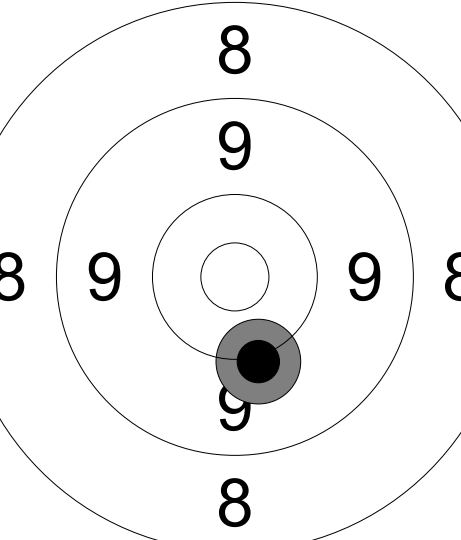
<p>1. Serie 5 Skud</p> 	<p>1: 10.1 ← 2: 10.4 ↗ 3: 9.3 ← 4: 9.4 → 5: 10.2 ↑</p>	<p>2. Serie 1 Skud</p> 	<p>1: 10.1 ↓</p>
Serie 49.4		Serie 10.1	
Total 49.4		Total 59.5	

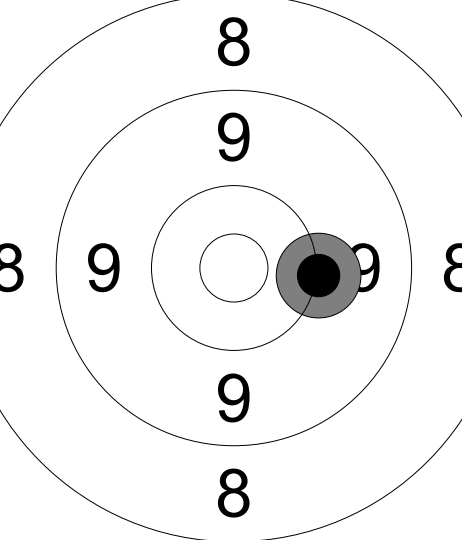
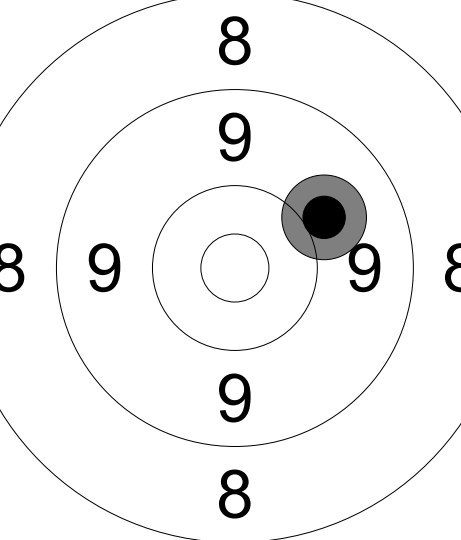
<p>3. Serie 1 Skud</p> 	<p>1: 10.1 →</p>	<p>4. Serie 1 Skud</p> 	<p>1: 10.0 ↗</p>
Serie 10.1		Serie 10.0	
Total 69.6		Total 79.6	

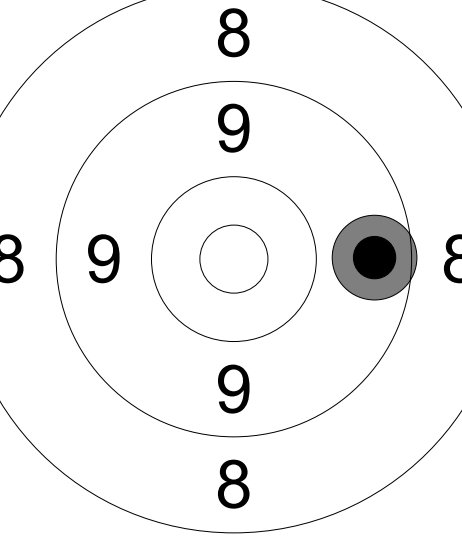
<p>5. Serie 1 Skud</p> 	<p>1: 9.6 →</p>		
Serie 9.6			
Total 89.2			

Hold 27	Skive 7	Freya Kofoed
-------------------	-------------------	---------------------

50M	Østerlars Skytteforening	FST
-----	--------------------------	-----

10.08.2024	EM 2024	Hanebjerg Skyttecenter
------------	---------	------------------------

Kommentar	Signatur
-----------	----------

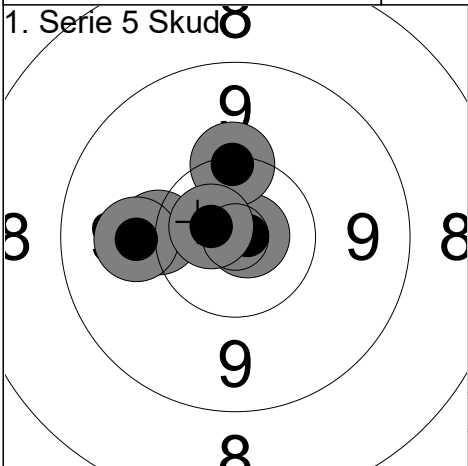

1: 10.8x →
2: 10.2 ←
3: 10.2 ↑
4: 10.0 ←
5: 10.7x ↖

Serie	51.9
Total	51.9

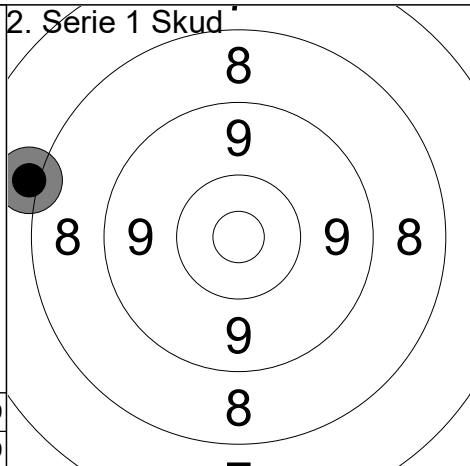

1: 8.0 ←

Serie	8.0
Total	59.9

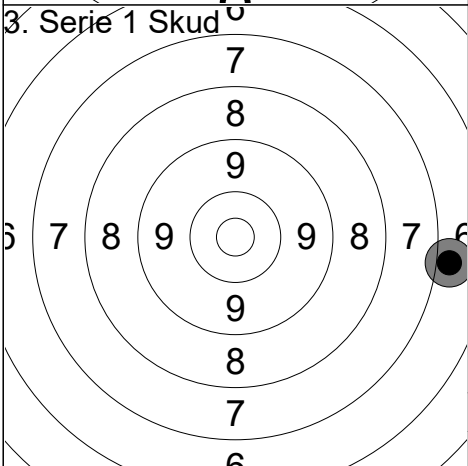

1: 6.9 →

Serie	6.9
Total	66.8

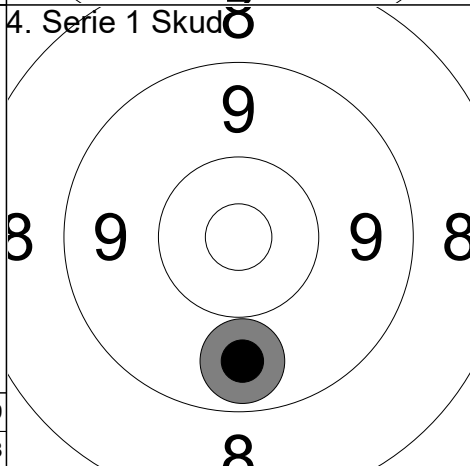

1: 9.7 ↓

Serie	9.7
Total	76.5

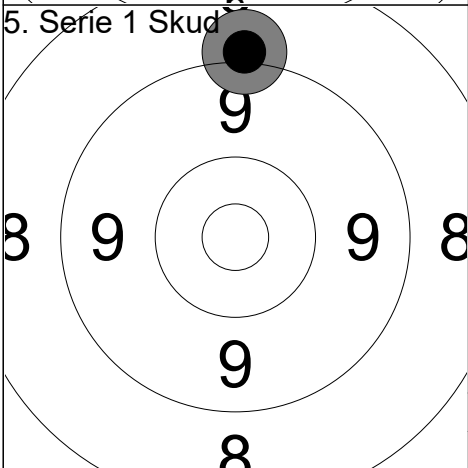

1: 9.1 ↑

Serie	9.1
Total	85.6

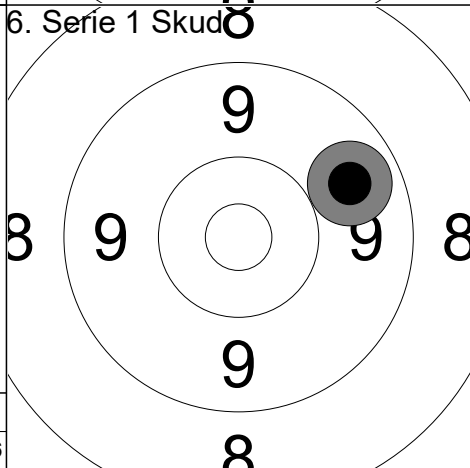

1: 9.7 →

Serie	9.7
Total	95.3

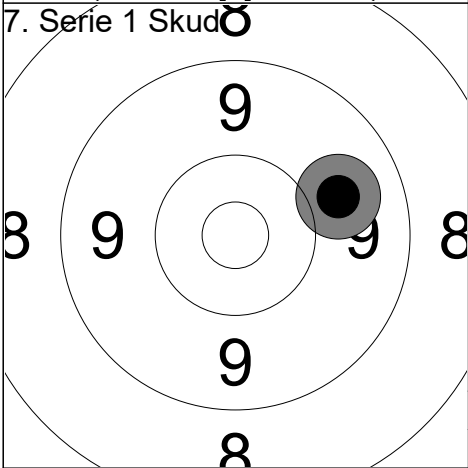

1: 9.9 →

Serie	9.9
Total	105.2

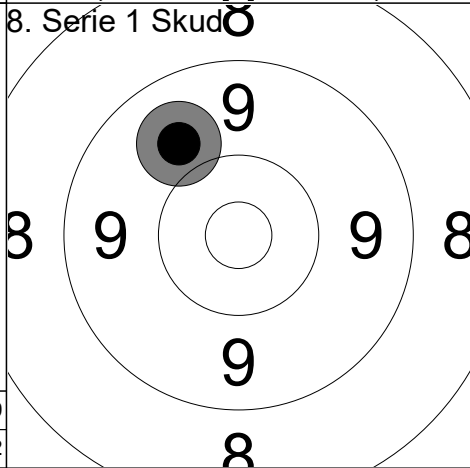

1: 9.9 ↖

Serie	9.9
Total	115.1

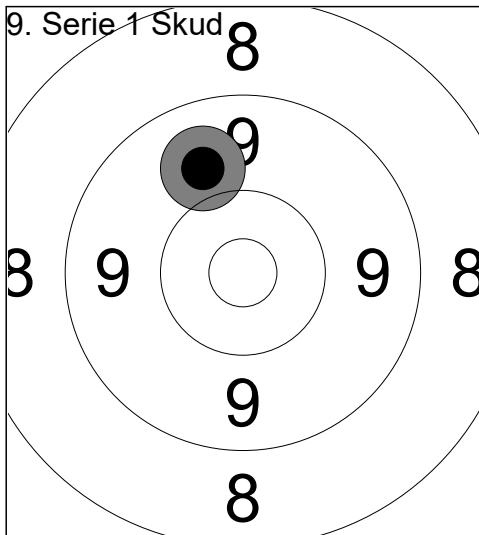

1: 9.9 ↖

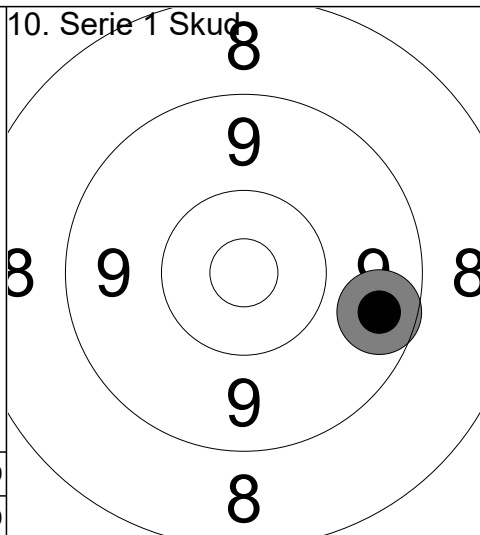

1: 9.6 →

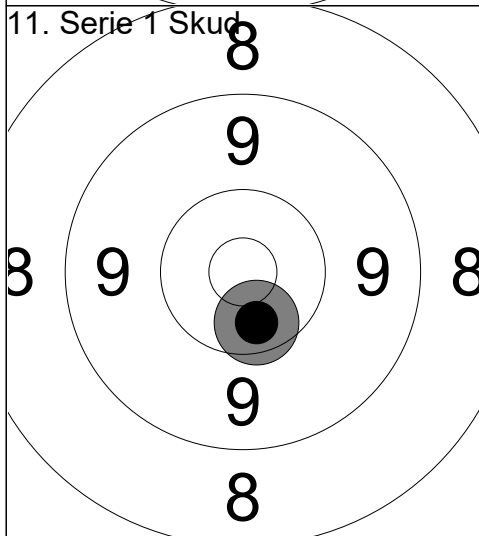

1: 10.4x ↓

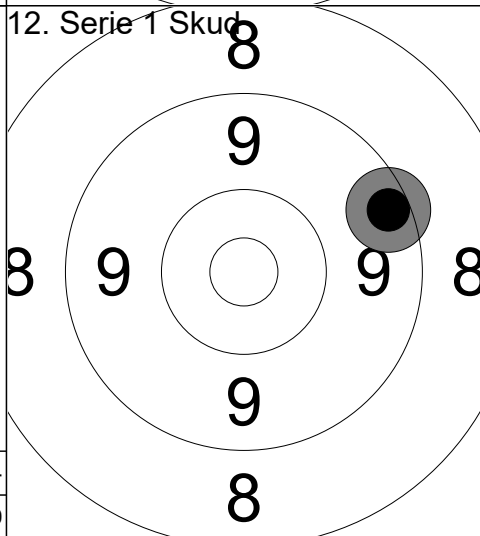

1: 9.4 →

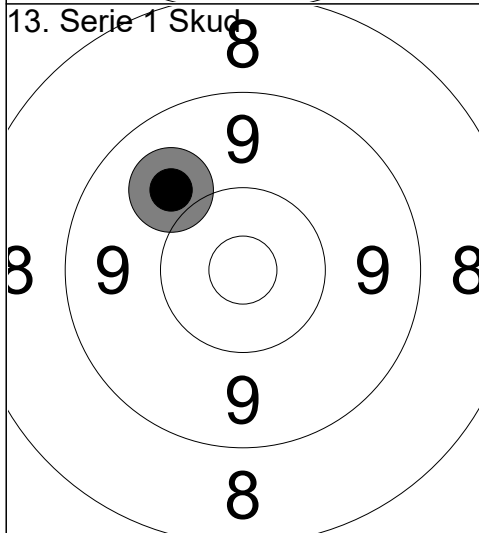

1: 9.9 ↖

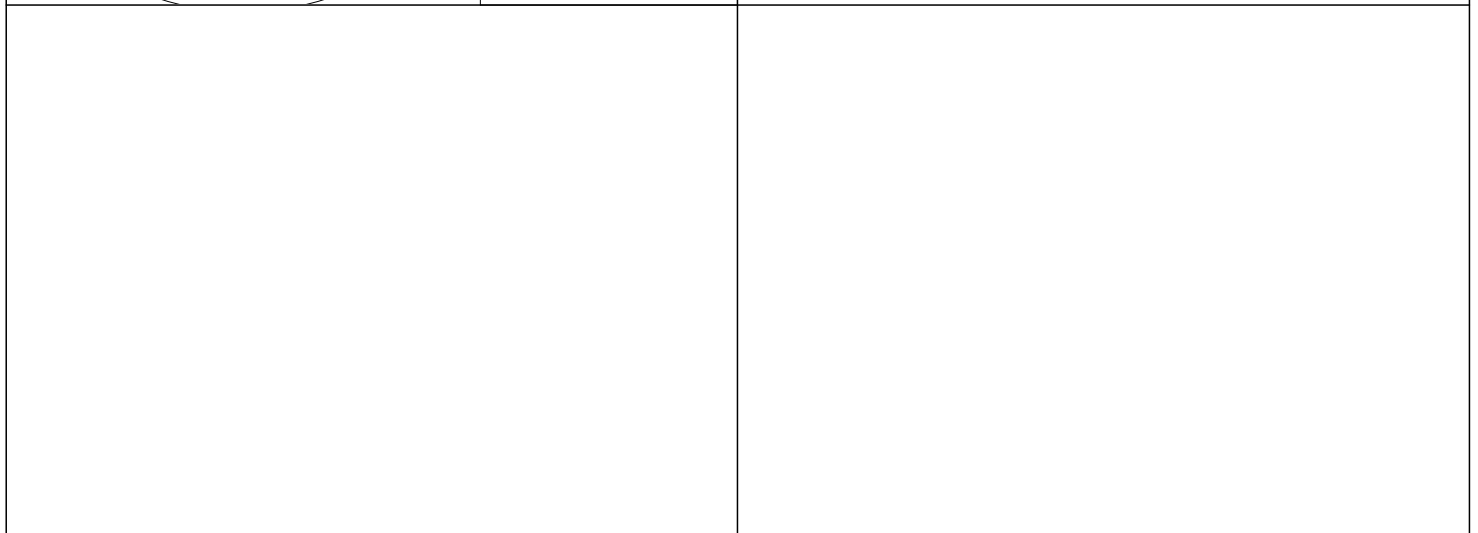

Hold 27	Skive 8	Mikkel Kannik	
50M	Ølstykke Skytteforening	FST	
10.08.2024	EM 2024	Hanebjerg Skyttecenter	
Kommentar	Signatur		

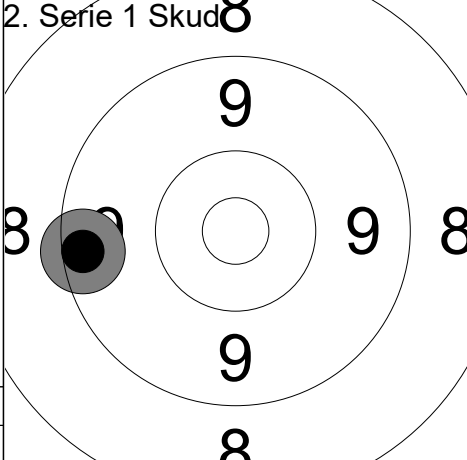
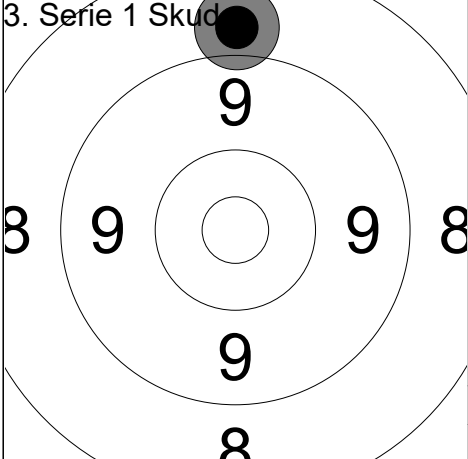
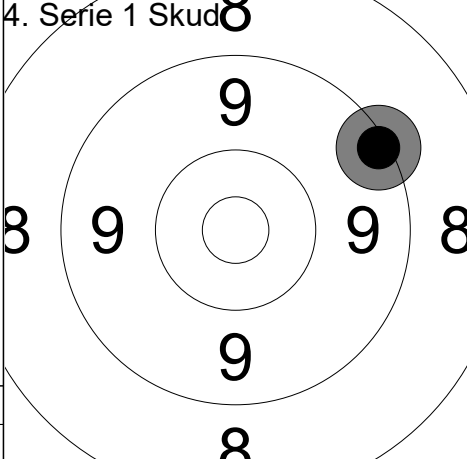
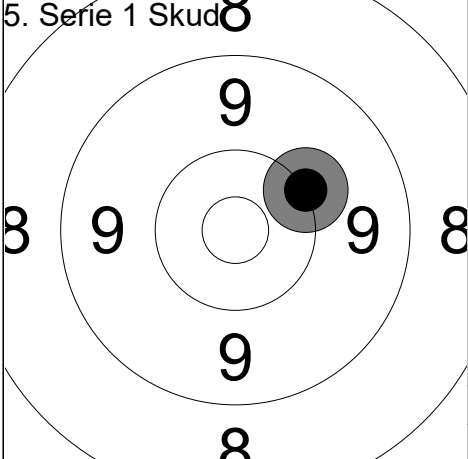
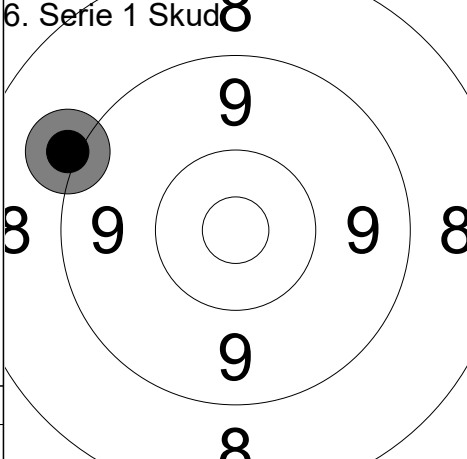
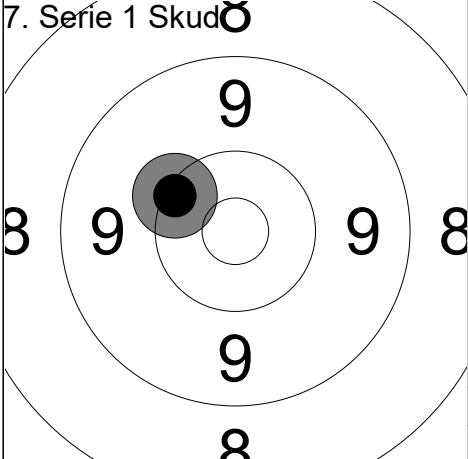
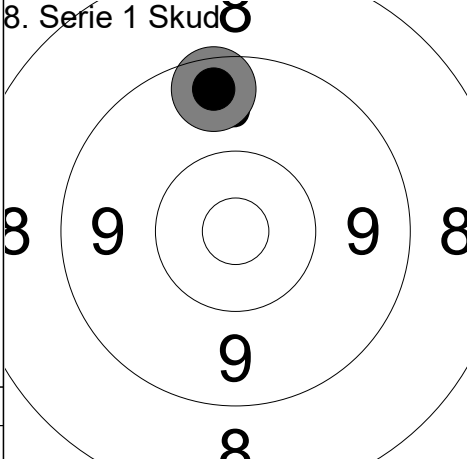
1. Serie 5 Skud 	1: 10.8x ↑ 2: 10.7x ↑ 3: 10.5x ↑ 4: 10.7x ↓ 5: 10.5x ←	2. Serie 1 Skud 	1: 9.4 ←
	Serie 53.2 Total 53.2		Serie 9.4 Total 62.6
3. Serie 1 Skud 	1: 8.9 ↑	4. Serie 1 Skud 	1: 9.3 ↗
	Serie 8.9 Total 71.5		Serie 9.3 Total 80.8
5. Serie 1 Skud 	1: 10.2 ↗	6. Serie 1 Skud 	1: 9.1 ←
	Serie 10.2 Total 91.0		Serie 9.1 Total 100.1
7. Serie 1 Skud 	1: 10.3 ←	8. Serie 1 Skud 	1: 9.5 ↑
	Serie 10.3 Total 110.4		Serie 9.5 Total 119.9

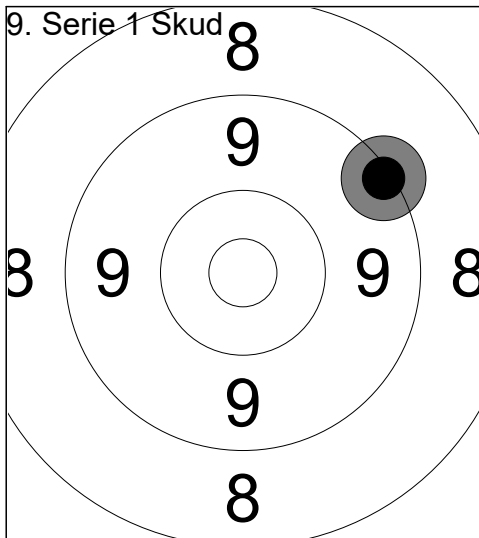

1: 9.3 ↗

Serie	9.3
Total	129.2

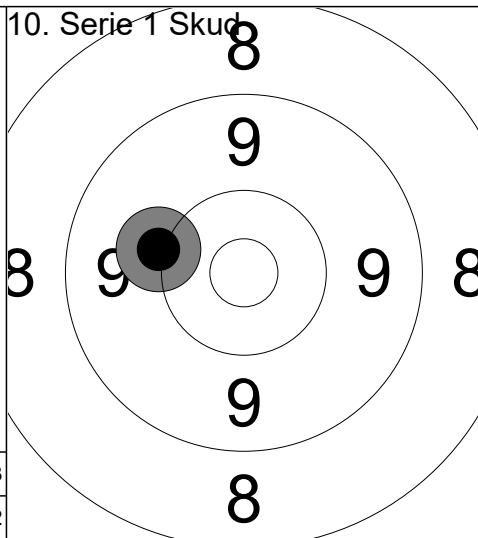

1: 10.1 ←

Serie	10.1
Total	139.3

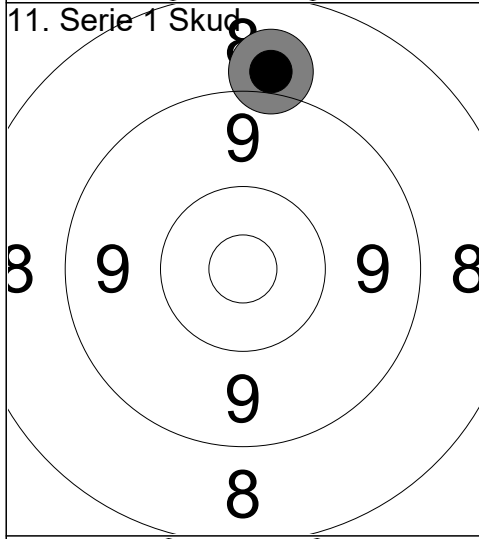

1: 9.0 ↑

Serie	9.0
Total	148.3

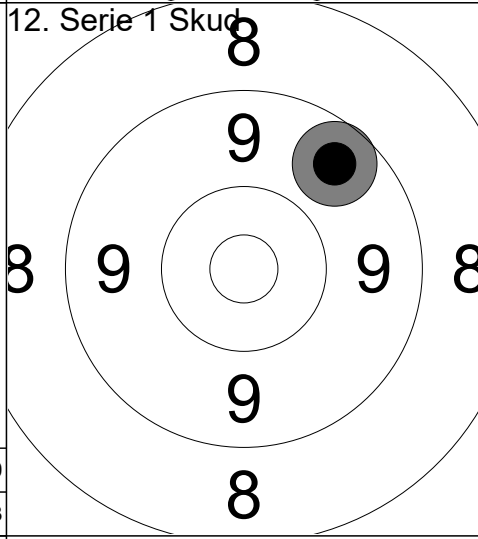

1: 9.6 ↗

Serie	9.6
Total	157.9

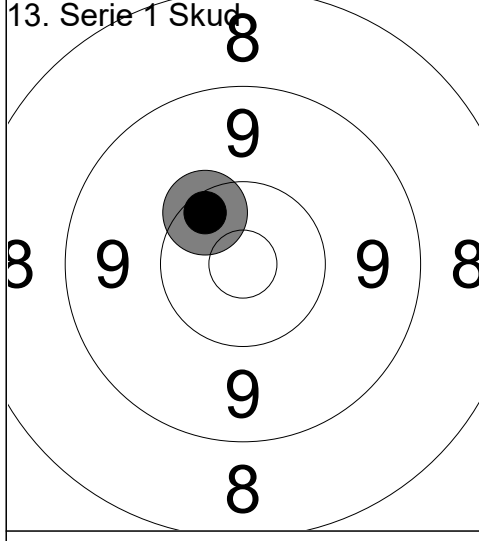

1: 10.3 ↖

Serie	10.3
Total	168.2

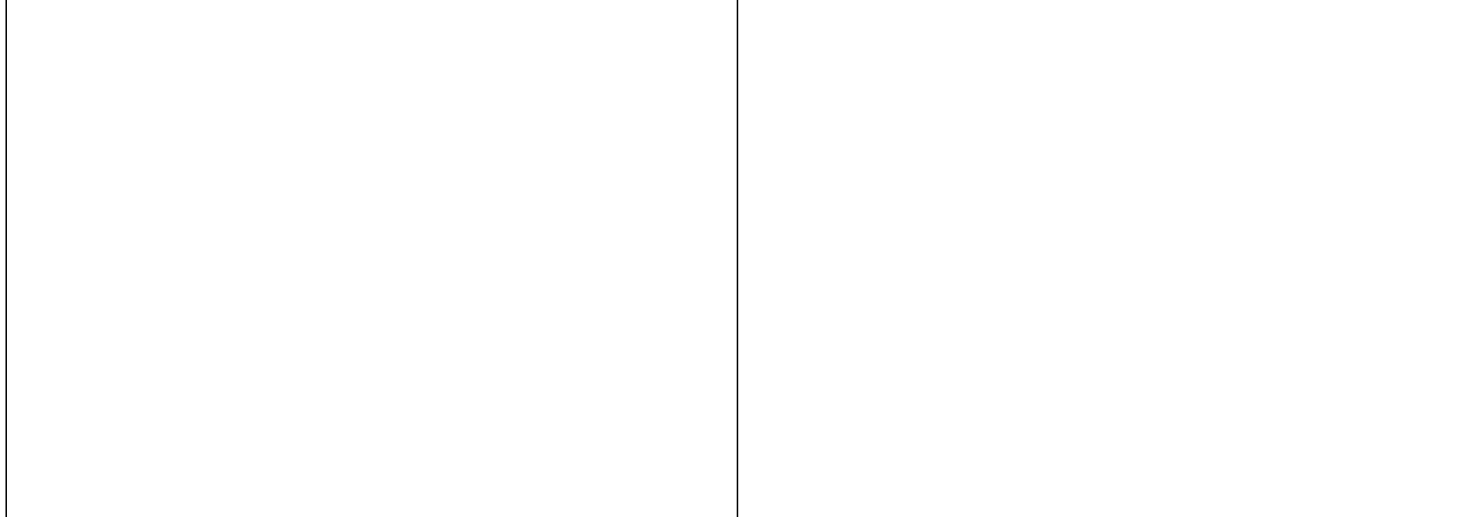

Hold 27	Skive 9	Jeannette Frost	
50M	Skyttelaugget Kgs. Lyngby	FST	
10.08.2024	EM 2024	Hanebjerg Skyttecenter	
Kommentar	Signatur		

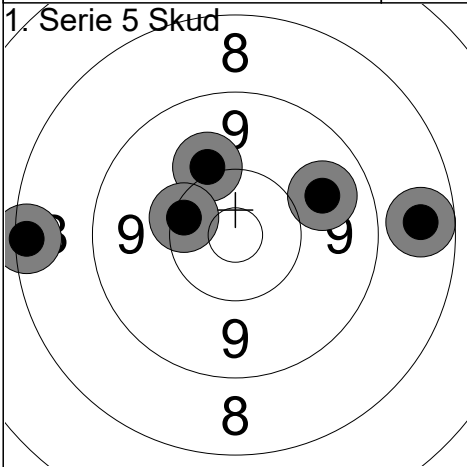

1:	8.3	←
2:	8.6	→
3:	10.1	↗
4:	10.3	←
5:	9.8	↗

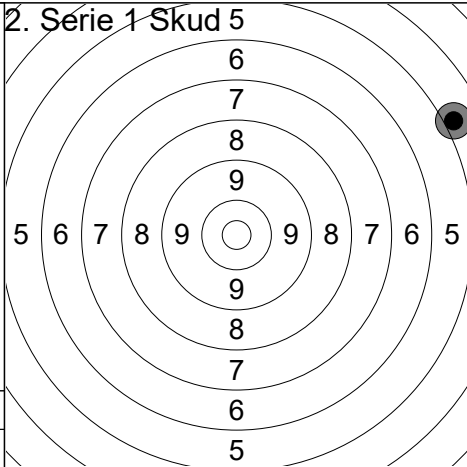

1:	4.9	↗
----	-----	---

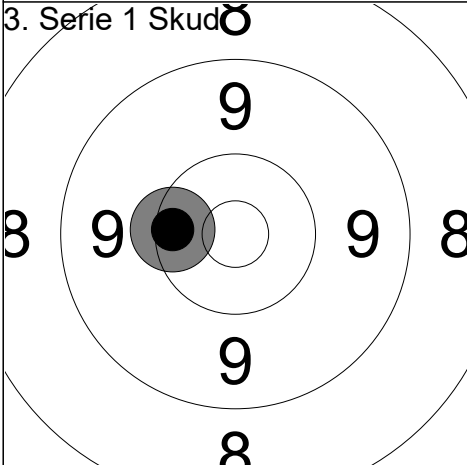

1:	10.3	←
----	------	---

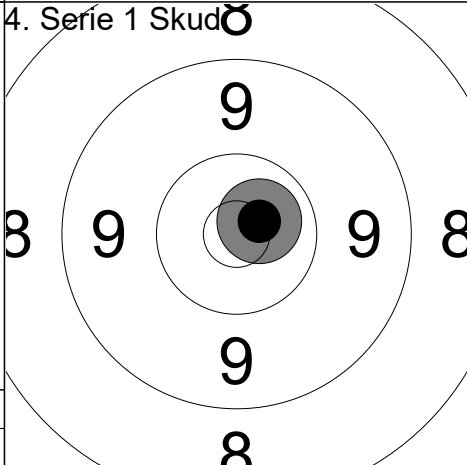

1:	10.7x	↗
----	-------	---

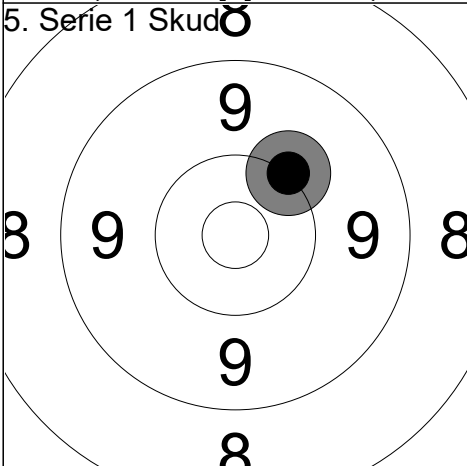

1:	10.1	↗
----	------	---

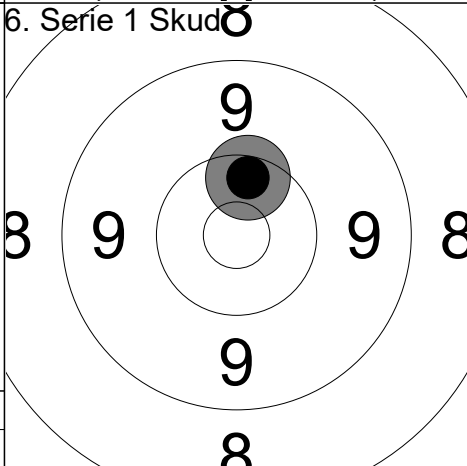

1:	10.4	↑
----	------	---

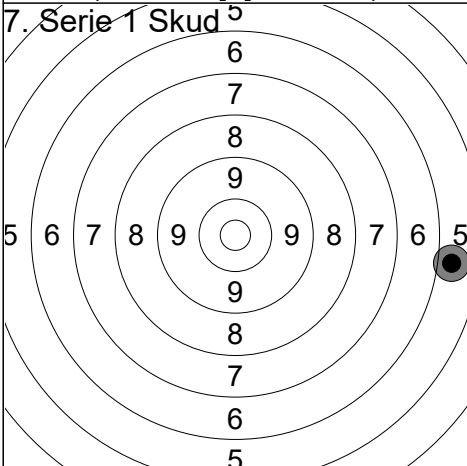

1:	5.8	→
----	-----	---

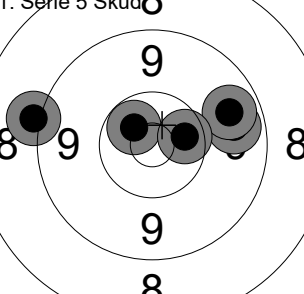
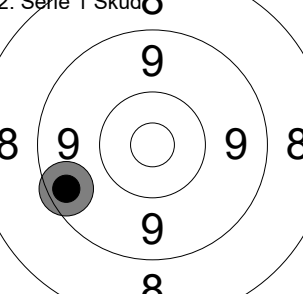
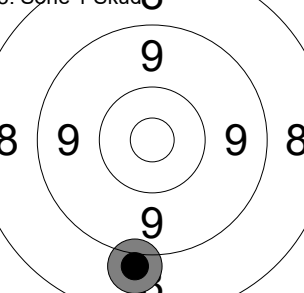
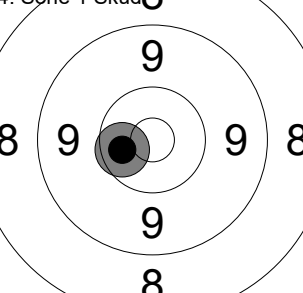
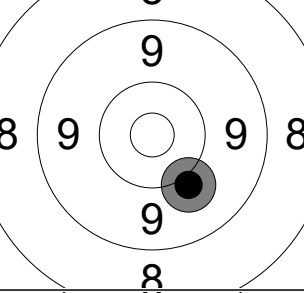
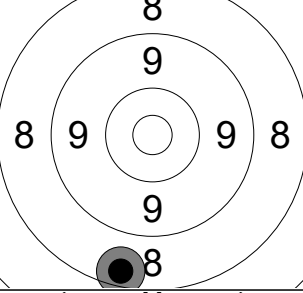
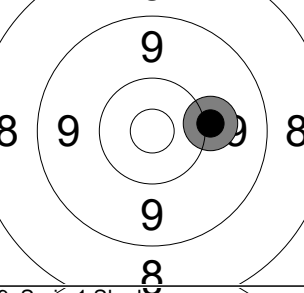
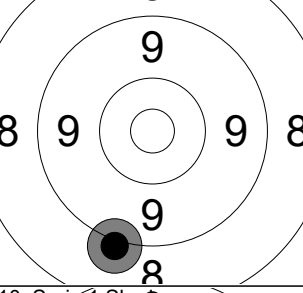
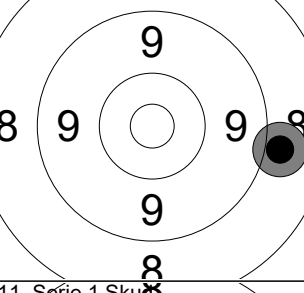
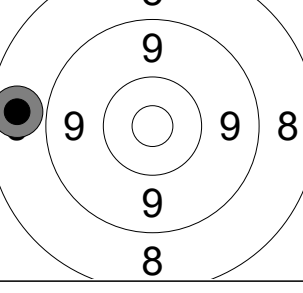
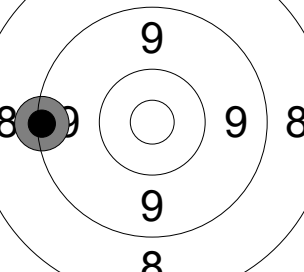
1. Serie 5 Skud 	1: 9.1 2: 9.7 3: 9.7 4: 10.6x 5: 10.4x	2. Serie 1 Skud 	1: 9.5								
	<table border="1" style="width:100%; border-collapse: collapse;"> <tr><td>Serie</td><td style="text-align: right;">49.5</td></tr> <tr><td>Total</td><td style="text-align: right;">49.5</td></tr> </table>	Serie	49.5	Total	49.5		<table border="1" style="width:100%; border-collapse: collapse;"> <tr><td>Serie</td><td style="text-align: right;">9.5</td></tr> <tr><td>Total</td><td style="text-align: right;">59.0</td></tr> </table>	Serie	9.5	Total	59.0
Serie	49.5										
Total	49.5										
Serie	9.5										
Total	59.0										
3. Serie 1 Skud 	1: 9.0	4. Serie 1 Skud 	1: 10.5x								
	<table border="1" style="width:100%; border-collapse: collapse;"> <tr><td>Serie</td><td style="text-align: right;">9.0</td></tr> <tr><td>Total</td><td style="text-align: right;">68.0</td></tr> </table>	Serie	9.0	Total	68.0		<table border="1" style="width:100%; border-collapse: collapse;"> <tr><td>Serie</td><td style="text-align: right;">10.5</td></tr> <tr><td>Total</td><td style="text-align: right;">78.5</td></tr> </table>	Serie	10.5	Total	78.5
Serie	9.0										
Total	68.0										
Serie	10.5										
Total	78.5										
5. Serie 1 Skud 	1: 10.0	6. Serie 1 Skud 	1: 8.5								
	<table border="1" style="width:100%; border-collapse: collapse;"> <tr><td>Serie</td><td style="text-align: right;">10.0</td></tr> <tr><td>Total</td><td style="text-align: right;">88.5</td></tr> </table>	Serie	10.0	Total	88.5		<table border="1" style="width:100%; border-collapse: collapse;"> <tr><td>Serie</td><td style="text-align: right;">8.5</td></tr> <tr><td>Total</td><td style="text-align: right;">97.0</td></tr> </table>	Serie	8.5	Total	97.0
Serie	10.0										
Total	88.5										
Serie	8.5										
Total	97.0										
7. Serie 1 Skud 	1: 10.1	8. Serie 1 Skud 	1: 9.1								
	<table border="1" style="width:100%; border-collapse: collapse;"> <tr><td>Serie</td><td style="text-align: right;">10.1</td></tr> <tr><td>Total</td><td style="text-align: right;">107.1</td></tr> </table>	Serie	10.1	Total	107.1		<table border="1" style="width:100%; border-collapse: collapse;"> <tr><td>Serie</td><td style="text-align: right;">9.1</td></tr> <tr><td>Total</td><td style="text-align: right;">116.2</td></tr> </table>	Serie	9.1	Total	116.2
Serie	10.1										
Total	107.1										
Serie	9.1										
Total	116.2										
9. Serie 1 Skud 	1: 8.9	10. Serie 1 Skud 	1: 8.7								
	<table border="1" style="width:100%; border-collapse: collapse;"> <tr><td>Serie</td><td style="text-align: right;">8.9</td></tr> <tr><td>Total</td><td style="text-align: right;">125.1</td></tr> </table>	Serie	8.9	Total	125.1		<table border="1" style="width:100%; border-collapse: collapse;"> <tr><td>Serie</td><td style="text-align: right;">8.7</td></tr> <tr><td>Total</td><td style="text-align: right;">133.8</td></tr> </table>	Serie	8.7	Total	133.8
Serie	8.9										
Total	125.1										
Serie	8.7										
Total	133.8										
11. Serie 1 Skud 	1: 9.2										
	<table border="1" style="width:100%; border-collapse: collapse;"> <tr><td>Serie</td><td style="text-align: right;">9.2</td></tr> <tr><td>Total</td><td style="text-align: right;">143.0</td></tr> </table>	Serie	9.2	Total	143.0						
Serie	9.2										
Total	143.0										

<p>1. Serie 5 Skud</p> <table border="1" style="width:100%; border-collapse: collapse;"> <tr><td>1:</td><td>9.6</td><td>←</td></tr> <tr><td>2:</td><td>10.1</td><td>↗</td></tr> <tr><td>3:</td><td>10.3</td><td>↗</td></tr> <tr><td>4:</td><td>8.5</td><td>↘</td></tr> <tr><td>5:</td><td>10.0</td><td>↘</td></tr> <tr><td colspan="2">Serie</td><td>48.5</td></tr> <tr><td colspan="2">Total</td><td>48.5</td></tr> </table>	1:	9.6	←	2:	10.1	↗	3:	10.3	↗	4:	8.5	↘	5:	10.0	↘	Serie		48.5	Total		48.5	<p>2. Serie 1 Skud</p> <table border="1" style="width:100%; border-collapse: collapse;"> <tr><td>1:</td><td>9.9</td><td>↖</td></tr> <tr><td colspan="2">Serie</td><td>9.9</td></tr> <tr><td colspan="2">Total</td><td>58.4</td></tr> </table>	1:	9.9	↖	Serie		9.9	Total		58.4
1:	9.6	←																													
2:	10.1	↗																													
3:	10.3	↗																													
4:	8.5	↘																													
5:	10.0	↘																													
Serie		48.5																													
Total		48.5																													
1:	9.9	↖																													
Serie		9.9																													
Total		58.4																													
<p>3. Serie 1 Skud</p> <table border="1" style="width:100%; border-collapse: collapse;"> <tr><td>1:</td><td>10.0</td><td>→</td></tr> <tr><td colspan="2">Serie</td><td>10.0</td></tr> <tr><td colspan="2">Total</td><td>68.4</td></tr> </table>	1:	10.0	→	Serie		10.0	Total		68.4	<p>4. Serie 1 Skud</p> <table border="1" style="width:100%; border-collapse: collapse;"> <tr><td>1:</td><td>9.1</td><td>↖</td></tr> <tr><td colspan="2">Serie</td><td>9.1</td></tr> <tr><td colspan="2">Total</td><td>77.5</td></tr> </table>	1:	9.1	↖	Serie		9.1	Total		77.5												
1:	10.0	→																													
Serie		10.0																													
Total		68.4																													
1:	9.1	↖																													
Serie		9.1																													
Total		77.5																													
<p>5. Serie 1 Skud</p> <table border="1" style="width:100%; border-collapse: collapse;"> <tr><td>1:</td><td>7.8</td><td>→</td></tr> <tr><td colspan="2">Serie</td><td>7.8</td></tr> <tr><td colspan="2">Total</td><td>85.3</td></tr> </table>	1:	7.8	→	Serie		7.8	Total		85.3	<p>6. Serie 1 Skud</p> <table border="1" style="width:100%; border-collapse: collapse;"> <tr><td>1:</td><td>9.6</td><td>↓</td></tr> <tr><td colspan="2">Serie</td><td>9.6</td></tr> <tr><td colspan="2">Total</td><td>94.9</td></tr> </table>	1:	9.6	↓	Serie		9.6	Total		94.9												
1:	7.8	→																													
Serie		7.8																													
Total		85.3																													
1:	9.6	↓																													
Serie		9.6																													
Total		94.9																													
<p>7. Serie 1 Skud</p> <table border="1" style="width:100%; border-collapse: collapse;"> <tr><td>1:</td><td>9.3</td><td>←</td></tr> <tr><td colspan="2">Serie</td><td>9.3</td></tr> <tr><td colspan="2">Total</td><td>104.2</td></tr> </table>	1:	9.3	←	Serie		9.3	Total		104.2	<p>8. Serie 1 Skud</p> <table border="1" style="width:100%; border-collapse: collapse;"> <tr><td>1:</td><td>8.6</td><td>↘</td></tr> <tr><td colspan="2">Serie</td><td>8.6</td></tr> <tr><td colspan="2">Total</td><td>112.8</td></tr> </table>	1:	8.6	↘	Serie		8.6	Total		112.8												
1:	9.3	←																													
Serie		9.3																													
Total		104.2																													
1:	8.6	↘																													
Serie		8.6																													
Total		112.8																													
<p>9. Serie 1 Skud</p> <table border="1" style="width:100%; border-collapse: collapse;"> <tr><td>1:</td><td>10.3</td><td>↑</td></tr> <tr><td colspan="2">Serie</td><td>10.3</td></tr> <tr><td colspan="2">Total</td><td>123.1</td></tr> </table>	1:	10.3	↑	Serie		10.3	Total		123.1																						
1:	10.3	↑																													
Serie		10.3																													
Total		123.1																													

<p>1. Serie 5 Skud</p>	<p>2. Serie 1 Skud</p> <p>1: 7.9 ↑ 2: 8.1 → 3: 10.6x ↘ 4: 10.2 ↗ 5: 9.7 ←</p>	<p>1: 7.6 ↙</p>
Serie 46.5	Serie 7.6	
Total 46.5	Total 54.1	

<p>3. Serie 1 Skud</p>	<p>4. Serie 1 Skud</p> <p>1: 7.4 ↑</p>	<p>1: 7.9 ↗</p>
Serie 7.4	Serie 7.9	
Total 61.5	Total 69.4	

<p>5. Serie 1 Skud</p>		
Serie 9.5		
Total 78.9		

<p>1. Serie 5 Skud </p> <table border="1" style="width:100%; border-collapse: collapse; margin-top: 10px;"> <tr><td>Serie</td><td style="text-align: right;">52.8</td></tr> <tr><td>Total</td><td style="text-align: right;">52.8</td></tr> </table>	Serie	52.8	Total	52.8	<p>2. Serie 1 Skud </p> <p>1: 10.5x ↗ 2: 10.6x ↗ 3: 10.8x ↘ 4: 10.3 ↗ 5: 10.6x →</p> <table border="1" style="width:100%; border-collapse: collapse; margin-top: 10px;"> <tr><td>Serie</td><td style="text-align: right;">9.9</td></tr> <tr><td>Total</td><td style="text-align: right;">62.7</td></tr> </table>	Serie	9.9	Total	62.7	<p>3. Serie 1 Skud </p> <p>1: 10.7x →</p> <table border="1" style="width:100%; border-collapse: collapse; margin-top: 10px;"> <tr><td>Serie</td><td style="text-align: right;">10.7</td></tr> <tr><td>Total</td><td style="text-align: right;">73.4</td></tr> </table>	Serie	10.7	Total	73.4	<p>4. Serie 1 Skud </p> <p>1: 10.6x →</p> <table border="1" style="width:100%; border-collapse: collapse; margin-top: 10px;"> <tr><td>Serie</td><td style="text-align: right;">10.6</td></tr> <tr><td>Total</td><td style="text-align: right;">84.0</td></tr> </table>	Serie	10.6	Total	84.0	<p>5. Serie 1 Skud </p> <p>1: 10.5x ↘</p> <table border="1" style="width:100%; border-collapse: collapse; margin-top: 10px;"> <tr><td>Serie</td><td style="text-align: right;">10.5</td></tr> <tr><td>Total</td><td style="text-align: right;">94.5</td></tr> </table>	Serie	10.5	Total	94.5	<p>6. Serie 1 Skud </p> <p>1: 10.7x ↑</p> <table border="1" style="width:100%; border-collapse: collapse; margin-top: 10px;"> <tr><td>Serie</td><td style="text-align: right;">10.7</td></tr> <tr><td>Total</td><td style="text-align: right;">105.2</td></tr> </table>	Serie	10.7	Total	105.2	<p>7. Serie 1 Skud </p> <p>1: 10.3 →</p> <table border="1" style="width:100%; border-collapse: collapse; margin-top: 10px;"> <tr><td>Serie</td><td style="text-align: right;">10.3</td></tr> <tr><td>Total</td><td style="text-align: right;">115.5</td></tr> </table>	Serie	10.3	Total	115.5	<p>8. Serie 1 Skud </p> <p>1: 10.7x ↑</p> <table border="1" style="width:100%; border-collapse: collapse; margin-top: 10px;"> <tr><td>Serie</td><td style="text-align: right;">10.7</td></tr> <tr><td>Total</td><td style="text-align: right;">126.2</td></tr> </table>	Serie	10.7	Total	126.2
Serie	52.8																																						
Total	52.8																																						
Serie	9.9																																						
Total	62.7																																						
Serie	10.7																																						
Total	73.4																																						
Serie	10.6																																						
Total	84.0																																						
Serie	10.5																																						
Total	94.5																																						
Serie	10.7																																						
Total	105.2																																						
Serie	10.3																																						
Total	115.5																																						
Serie	10.7																																						
Total	126.2																																						

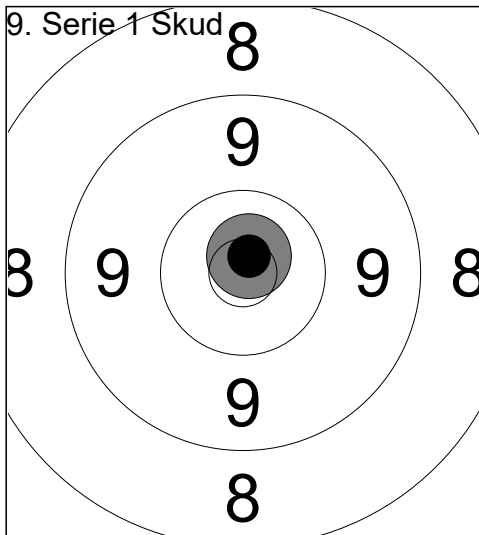

1: 10.8x ↗

Serie	10.8
Total	137.0

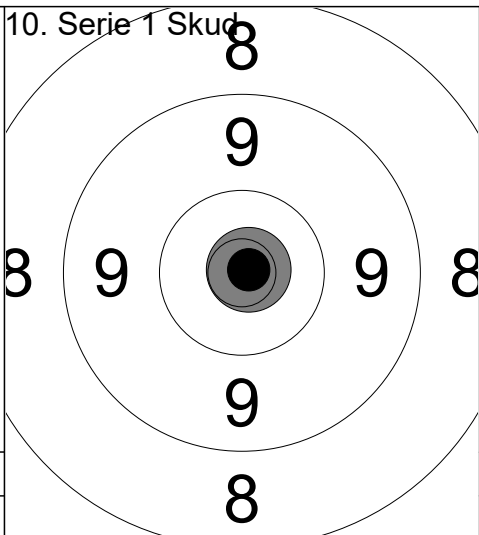

1: 10.9x ↘

Serie	10.9
Total	147.9

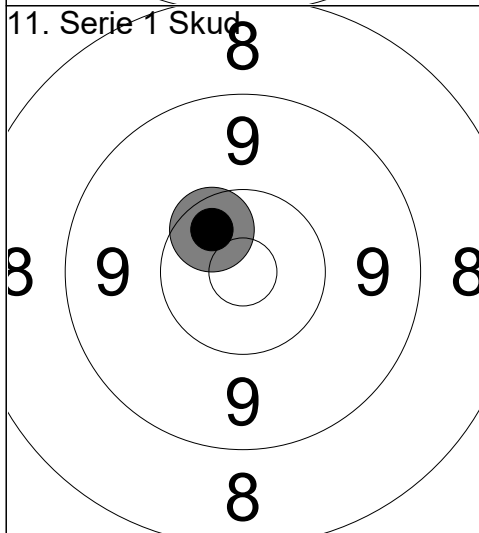

1: 10.4x ↖

Serie	10.4
Total	158.3

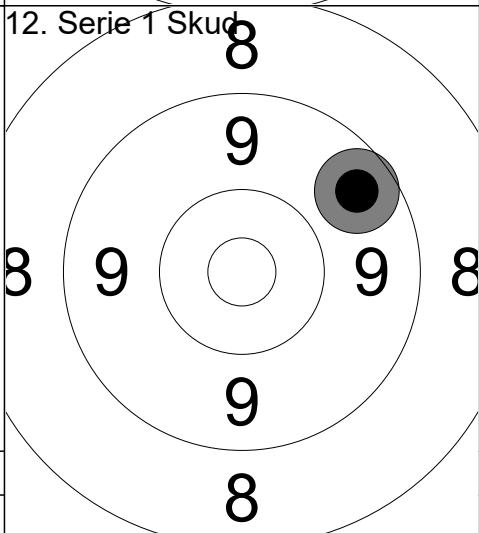

1: 9.6 ↗

Serie	9.6
Total	167.9

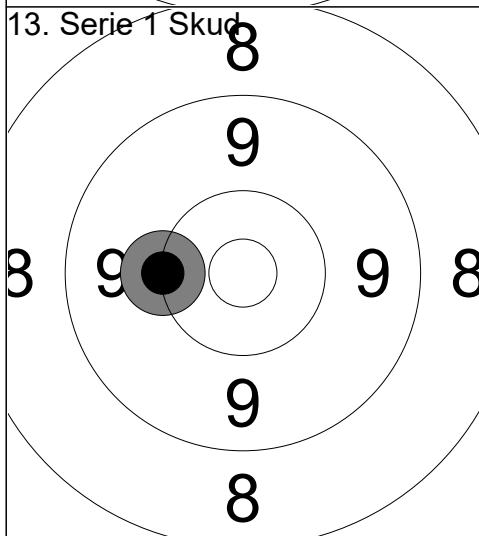





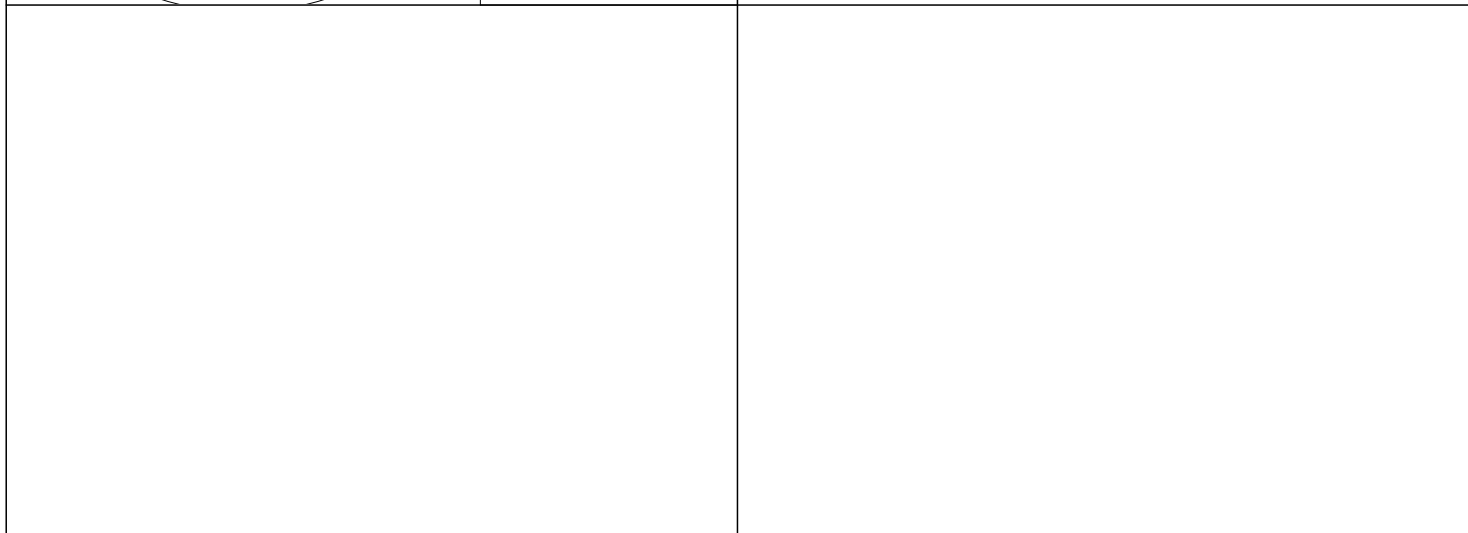



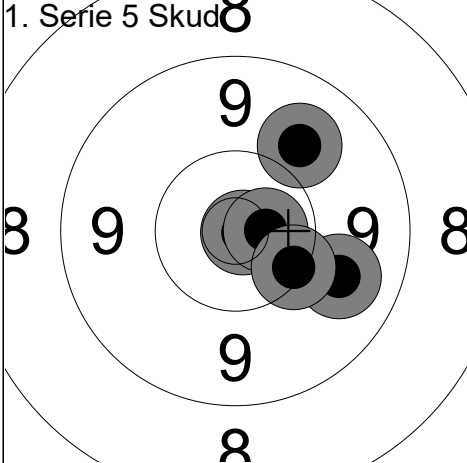

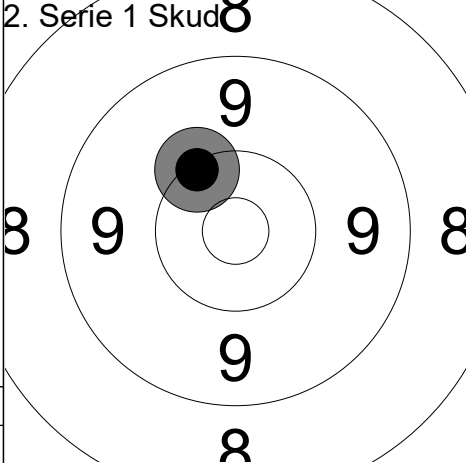

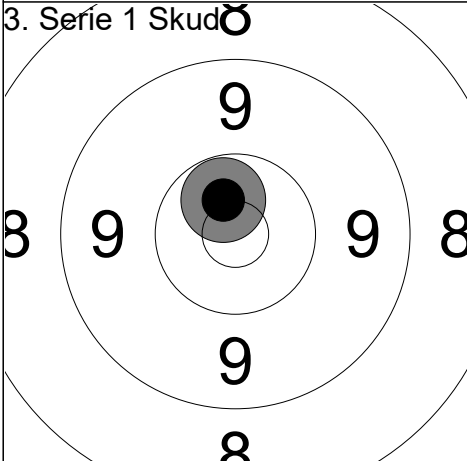

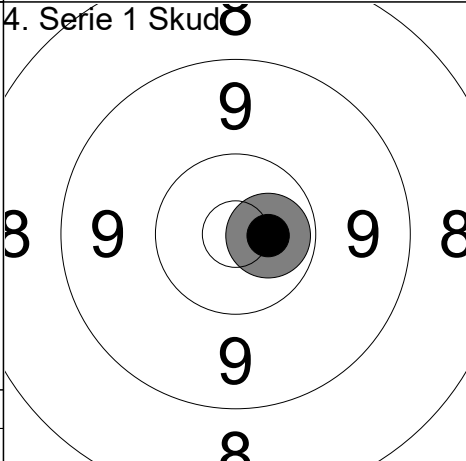
1: 10.2 ←

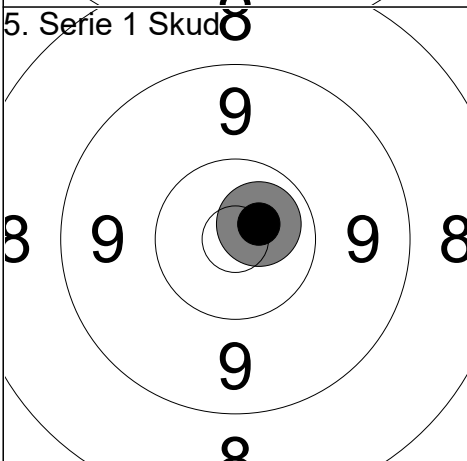
Serie	10.2
Total	178.1

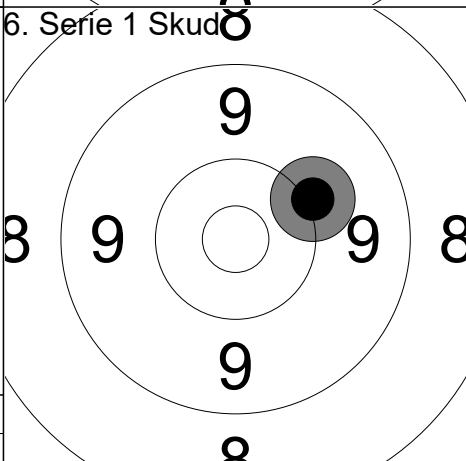

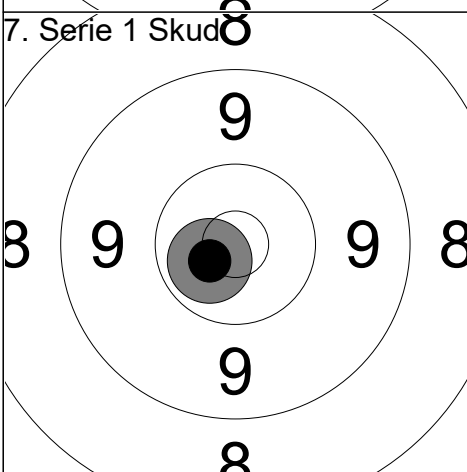
Hold 28	Skive 2	Ida Aaslev Noerager Bay		
50M		Ølstykke Skytteforening		FJUN
10.08.2024		EM 2024		Hanebjerg Skyttecenter
Kommentar		Signatur		

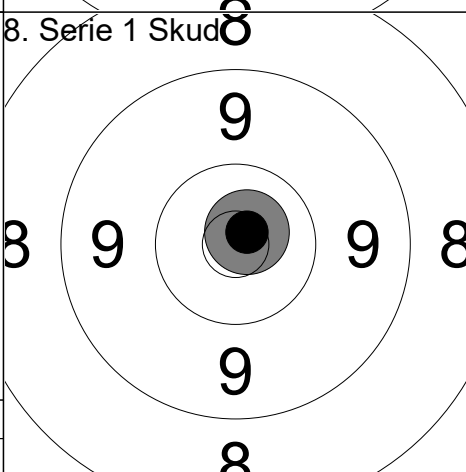
<p>1. Serie 5 Skud </p> 	<p>1: 10.9x → 2: 9.8 ↘ 3: 10.7x → 4: 10.3 ↘ 5: 9.9 ↗</p> <table border="1"> <tr><td>Serie</td><td>51.6</td></tr> <tr><td>Total</td><td>51.6</td></tr> </table>	Serie	51.6	Total	51.6	<p>2. Serie 1 Skud </p> 	<p>1: 10.2 ↗</p> <table border="1"> <tr><td>Serie</td><td>10.2</td></tr> <tr><td>Total</td><td>61.8</td></tr> </table>	Serie	10.2	Total	61.8
Serie	51.6										
Total	51.6										
Serie	10.2										
Total	61.8										
<p>3. Serie 1 Skud </p> 	<p>1: 10.6x ↗</p> <table border="1"> <tr><td>Serie</td><td>10.6</td></tr> <tr><td>Total</td><td>72.4</td></tr> </table>	Serie	10.6	Total	72.4	<p>4. Serie 1 Skud </p> 	<p>1: 10.6x →</p> <table border="1"> <tr><td>Serie</td><td>10.6</td></tr> <tr><td>Total</td><td>83.0</td></tr> </table>	Serie	10.6	Total	83.0
Serie	10.6										
Total	72.4										
Serie	10.6										
Total	83.0										
<p>5. Serie 1 Skud </p> 	<p>1: 10.7x ↗</p> <table border="1"> <tr><td>Serie</td><td>10.7</td></tr> <tr><td>Total</td><td>93.7</td></tr> </table>	Serie	10.7	Total	93.7	<p>6. Serie 1 Skud </p> 	<p>1: 10.1 ↗</p> <table border="1"> <tr><td>Serie</td><td>10.1</td></tr> <tr><td>Total</td><td>103.8</td></tr> </table>	Serie	10.1	Total	103.8
Serie	10.7										
Total	93.7										
Serie	10.1										
Total	103.8										
<p>7. Serie 1 Skud </p> 	<p>1: 10.7x ↖</p> <table border="1"> <tr><td>Serie</td><td>10.7</td></tr> <tr><td>Total</td><td>114.5</td></tr> </table>	Serie	10.7	Total	114.5	<p>8. Serie 1 Skud </p> 	<p>1: 10.8x ↗</p> <table border="1"> <tr><td>Serie</td><td>10.8</td></tr> <tr><td>Total</td><td>125.3</td></tr> </table>	Serie	10.8	Total	125.3
Serie	10.7										
Total	114.5										
Serie	10.8										
Total	125.3										

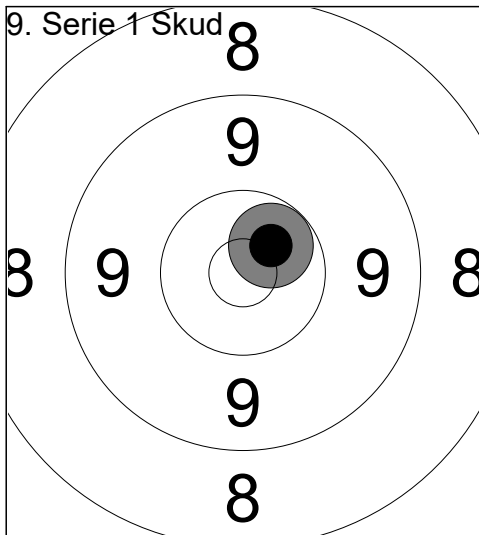

1: 10.6x ↗

Serie	10.6
Total	135.9

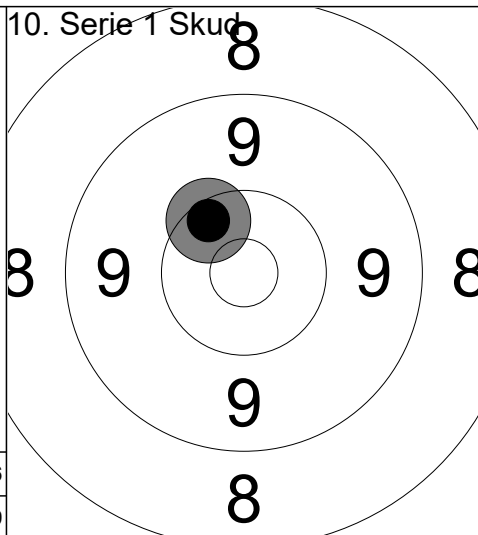

1: 10.3 ↖

Serie	10.3
Total	146.2

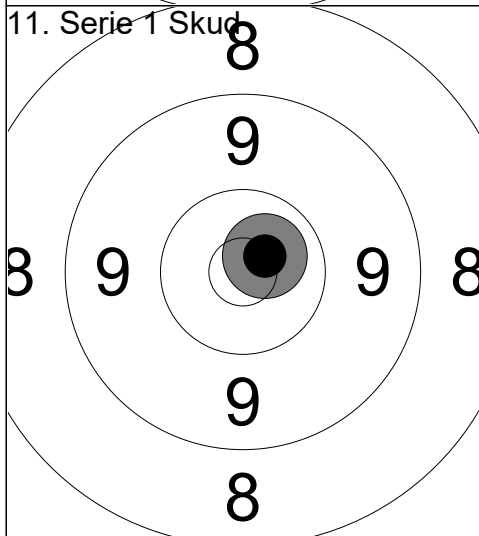

1: 10.7x ↗

Serie	10.7
Total	156.9

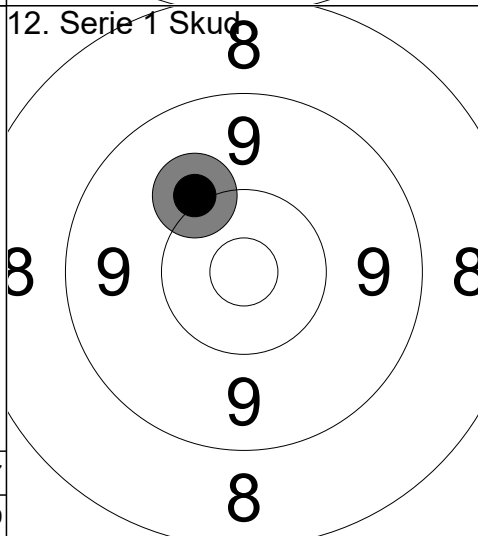

1: 10.1 ↖

Serie	10.1
Total	167.0

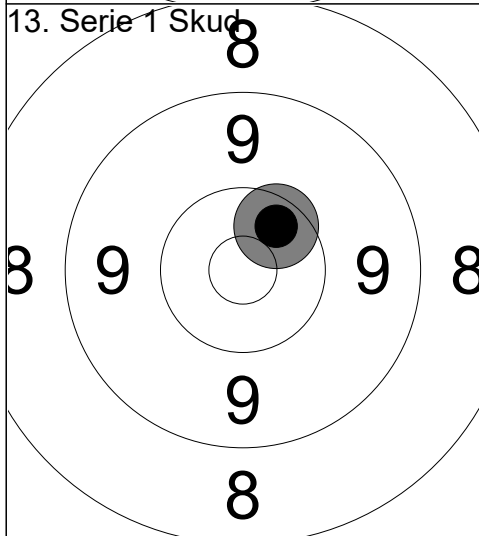

1: 10.4x ↗

Serie	10.4
Total	177.4

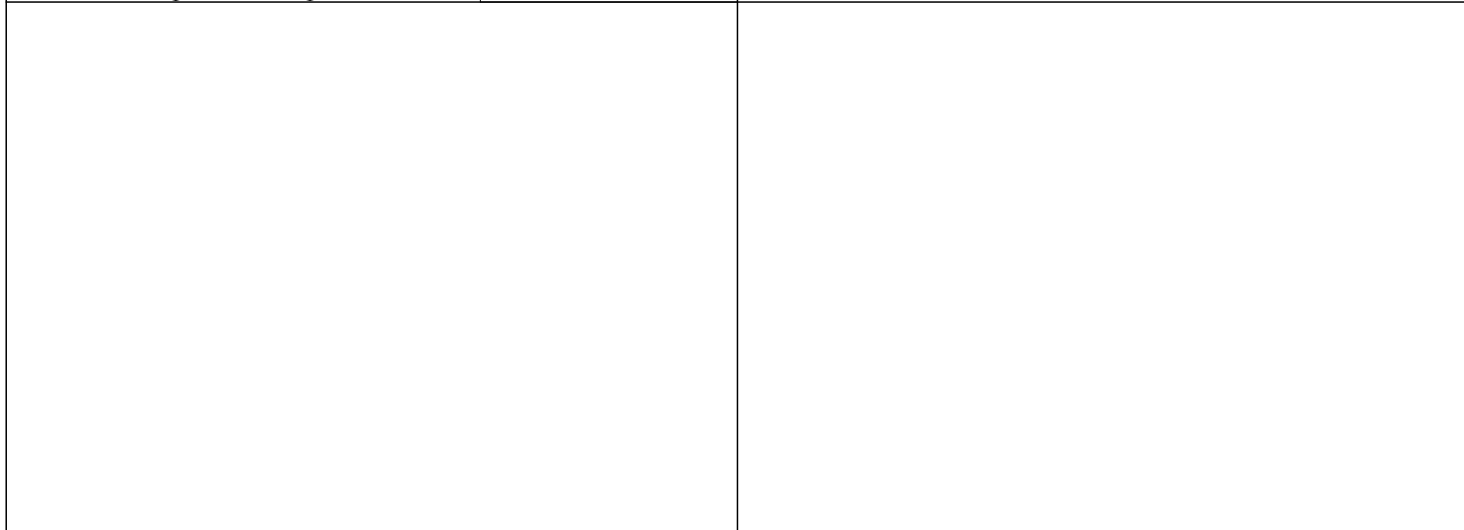

<p>1. Serie 5 Skud </p>	<p>1: 10.2 ↗ 2: 10.4 ↗ 3: 9.8 ↗ 4: 10.0 ↘ 5: 9.5 →</p>	<p>2. Serie 1 Skud </p>	<p>1: 10.2 ↘</p>								
	<table border="1" style="width:100%; border-collapse: collapse;"> <tr><td>Serie</td><td style="text-align: right;">49.9</td></tr> <tr><td>Total</td><td style="text-align: right;">49.9</td></tr> </table>	Serie	49.9	Total	49.9		<table border="1" style="width:100%; border-collapse: collapse;"> <tr><td>Serie</td><td style="text-align: right;">10.2</td></tr> <tr><td>Total</td><td style="text-align: right;">60.1</td></tr> </table>	Serie	10.2	Total	60.1
Serie	49.9										
Total	49.9										
Serie	10.2										
Total	60.1										
<p>3. Serie 1 Skud </p>	<p>1: 10.5x →</p>	<p>4. Serie 1 Skud </p>	<p>1: 10.3 ↗</p>								
	<table border="1" style="width:100%; border-collapse: collapse;"> <tr><td>Serie</td><td style="text-align: right;">10.5</td></tr> <tr><td>Total</td><td style="text-align: right;">70.6</td></tr> </table>	Serie	10.5	Total	70.6		<table border="1" style="width:100%; border-collapse: collapse;"> <tr><td>Serie</td><td style="text-align: right;">10.3</td></tr> <tr><td>Total</td><td style="text-align: right;">80.9</td></tr> </table>	Serie	10.3	Total	80.9
Serie	10.5										
Total	70.6										
Serie	10.3										
Total	80.9										
<p>5. Serie 1 Skud </p>	<p>1: 9.8 ↗</p>	<p>6. Serie 1 Skud </p>	<p>1: 10.3 →</p>								
	<table border="1" style="width:100%; border-collapse: collapse;"> <tr><td>Serie</td><td style="text-align: right;">9.8</td></tr> <tr><td>Total</td><td style="text-align: right;">90.7</td></tr> </table>	Serie	9.8	Total	90.7		<table border="1" style="width:100%; border-collapse: collapse;"> <tr><td>Serie</td><td style="text-align: right;">10.3</td></tr> <tr><td>Total</td><td style="text-align: right;">101.0</td></tr> </table>	Serie	10.3	Total	101.0
Serie	9.8										
Total	90.7										
Serie	10.3										
Total	101.0										
<p>7. Serie 1 Skud </p>	<p>1: 10.7x ↖</p>	<p>8. Serie 1 Skud </p>	<p>1: 10.8x →</p>								
	<table border="1" style="width:100%; border-collapse: collapse;"> <tr><td>Serie</td><td style="text-align: right;">10.7</td></tr> <tr><td>Total</td><td style="text-align: right;">111.7</td></tr> </table>	Serie	10.7	Total	111.7		<table border="1" style="width:100%; border-collapse: collapse;"> <tr><td>Serie</td><td style="text-align: right;">10.8</td></tr> <tr><td>Total</td><td style="text-align: right;">122.5</td></tr> </table>	Serie	10.8	Total	122.5
Serie	10.7										
Total	111.7										
Serie	10.8										
Total	122.5										
<p>9. Serie 1 Skud </p>	<p>1: 10.4 ↑</p>										
	<table border="1" style="width:100%; border-collapse: collapse;"> <tr><td>Serie</td><td style="text-align: right;">10.4</td></tr> <tr><td>Total</td><td style="text-align: right;">132.9</td></tr> </table>	Serie	10.4	Total	132.9						
Serie	10.4										
Total	132.9										

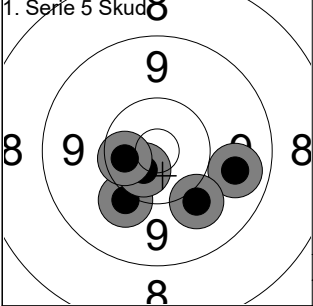
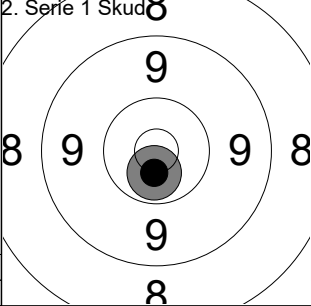
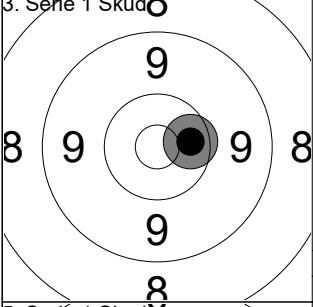
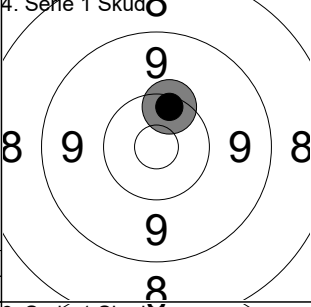
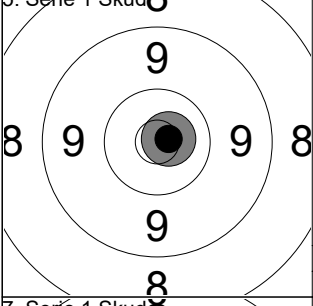
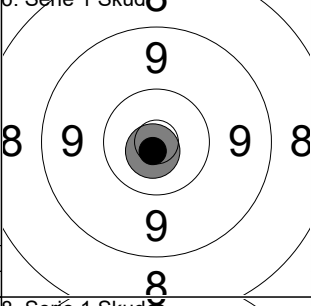
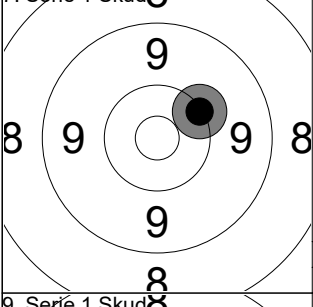
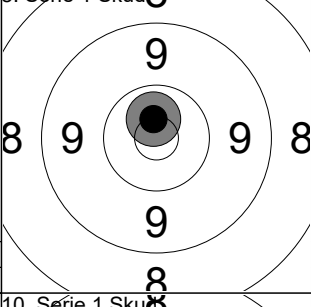
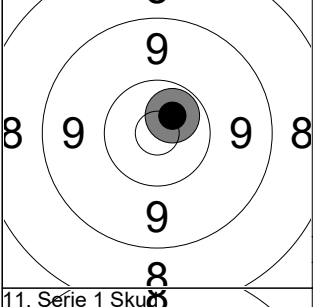
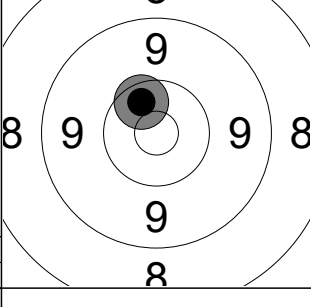
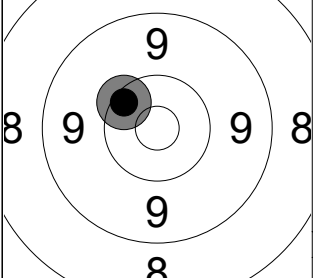
1. Serie 5 Skud 	1: 10.1 2: 10.6x 3: 9.7 4: 10.4x 5: 10.0	2. Serie 1 Skud 	1: 10.6x
	Serie 50.8 Total 50.8		Serie 10.6 Total 61.4
3. Serie 1 Skud 	1: 10.4x	4. Serie 1 Skud 	1: 10.3
	Serie 10.4 Total 71.8		Serie 10.3 Total 82.1
5. Serie 1 Skud 	1: 10.8x	6. Serie 1 Skud 	1: 10.8x
	Serie 10.8 Total 92.9		Serie 10.8 Total 103.7
7. Serie 1 Skud 	1: 10.2	8. Serie 1 Skud 	1: 10.7x
	Serie 10.2 Total 113.9		Serie 10.7 Total 124.6
9. Serie 1 Skud 	1: 10.6x	10. Serie 1 Skud 	1: 10.4x
	Serie 10.6 Total 135.2		Serie 10.4 Total 145.6
11. Serie 1 Skud 	1: 10.3		
	Serie 10.3 Total 155.9		

Hold 28	Skive 5	Amanda Jensen		
50M		Frederikssund Skytteforening, I		FJUN
10.08.2024		EM 2024		Hanebjerg Skyttecenter
Kommentar		Signatur		

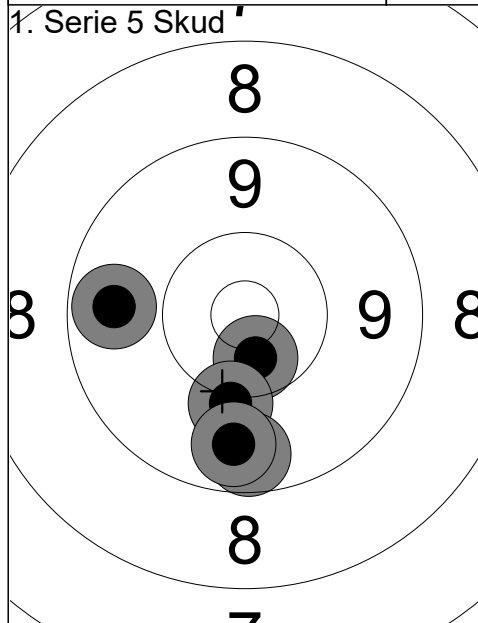

1:	10.5x	↓
2:	10.1	↓
3:	9.6	↓
4:	9.7	←
5:	9.7	↓
Serie		49.6
Total		49.6

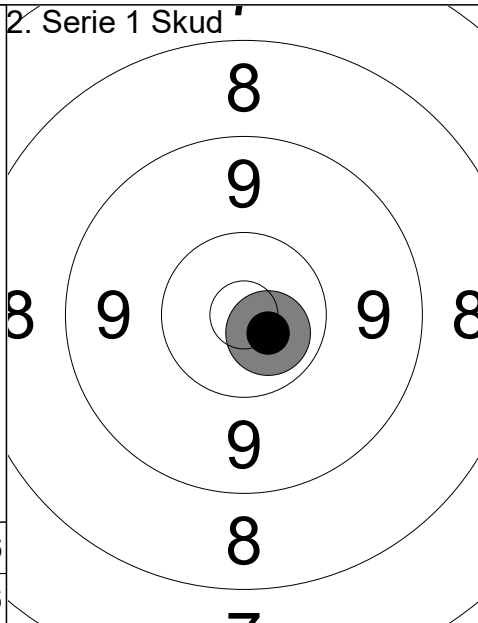

1:	10.7x	↘
Serie		10.7
Total		60.3

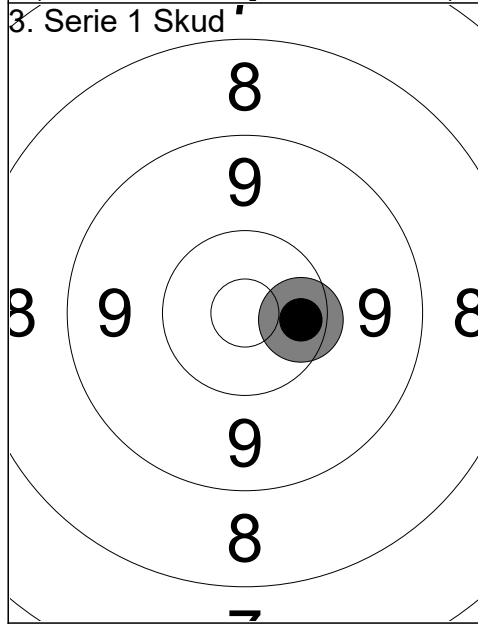

1:	10.4	→
Serie		10.4
Total		70.7

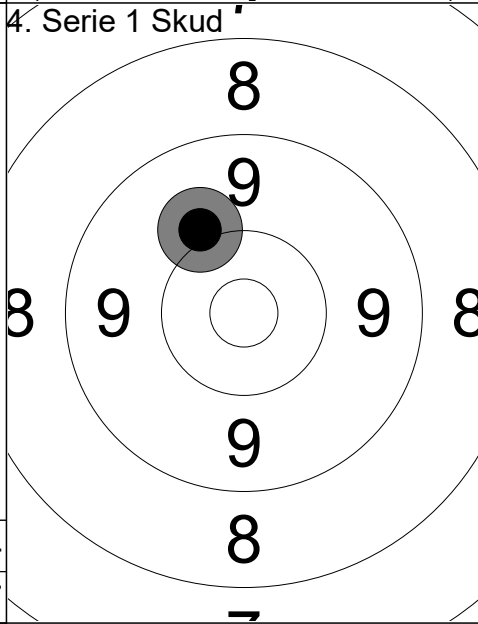

1:	10.0	↖
Serie		10.0
Total		80.7

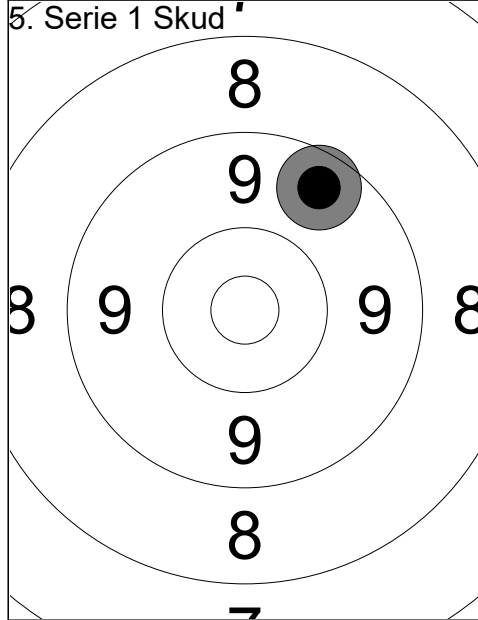

1:	9.5	↗
Serie		9.5
Total		90.2

Hold 28	Skive 6	Jonas Keiding
-------------------	-------------------	----------------------

50M	Kreds 57, Ferslev, Skibby	FJUN
-----	---------------------------	------

10.08.2024	EM 2024	Hanebjerg Skyttecenter
------------	---------	------------------------

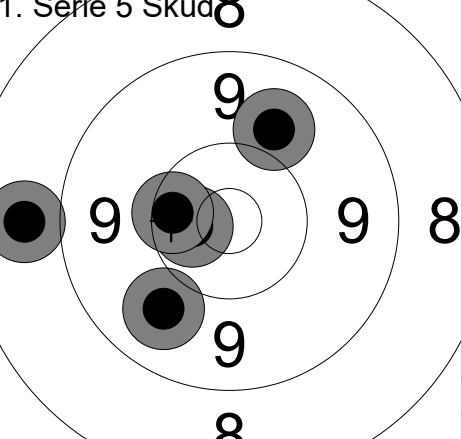
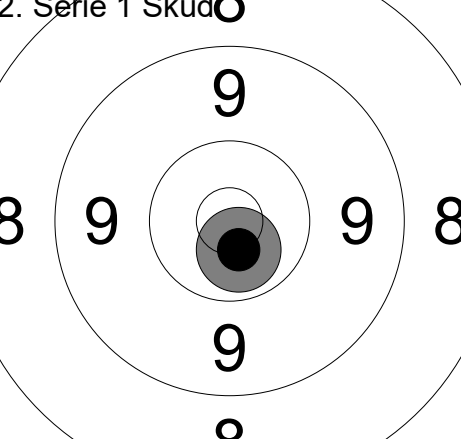

Kommentar	Signatur
-----------	----------

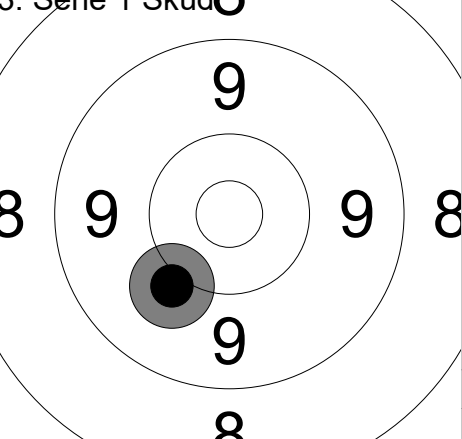
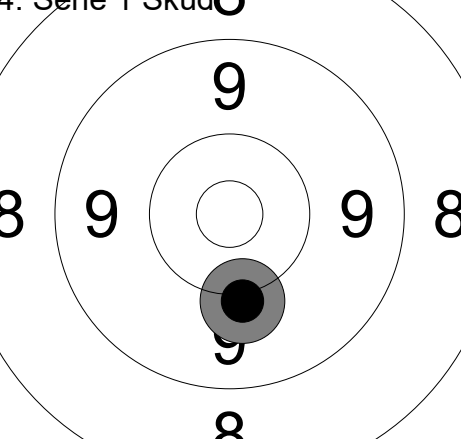
<p>1. Serie 5 Skud </p> <p>1: 9.8 ↘ 2: 10.6x ← 3: 8.8 ← 4: 9.9 ↗ 5: 10.4 ←</p> <table border="1" style="width:100%; border-collapse: collapse;"> <tr><td>Serie</td><td style="text-align: right;">49.5</td></tr> <tr><td>Total</td><td style="text-align: right;">49.5</td></tr> </table>	Serie	49.5	Total	49.5	<p>2. Serie 1 Skud </p> <p>1: 10.7x ↘</p> <table border="1" style="width:100%; border-collapse: collapse;"> <tr><td>Serie</td><td style="text-align: right;">10.7</td></tr> <tr><td>Total</td><td style="text-align: right;">60.2</td></tr> </table>	Serie	10.7	Total	60.2
Serie	49.5								
Total	49.5								
Serie	10.7								
Total	60.2								

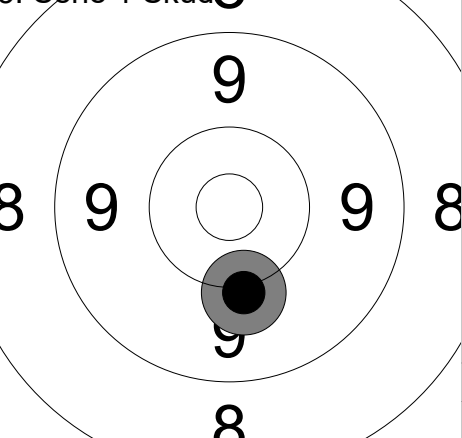
<p>3. Serie 1 Skud </p> <p>1: 10.0 ↘</p> <table border="1" style="width:100%; border-collapse: collapse;"> <tr><td>Serie</td><td style="text-align: right;">10.0</td></tr> <tr><td>Total</td><td style="text-align: right;">70.2</td></tr> </table>	Serie	10.0	Total	70.2	<p>4. Serie 1 Skud </p> <p>1: 10.1 ↘</p> <table border="1" style="width:100%; border-collapse: collapse;"> <tr><td>Serie</td><td style="text-align: right;">10.1</td></tr> <tr><td>Total</td><td style="text-align: right;">80.3</td></tr> </table>	Serie	10.1	Total	80.3
Serie	10.0								
Total	70.2								
Serie	10.1								
Total	80.3								

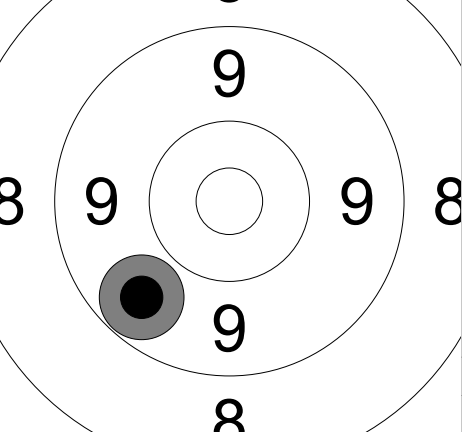
<p>5. Serie 1 Skud </p> <p>1: 10.1 ↘</p> <table border="1" style="width:100%; border-collapse: collapse;"> <tr><td>Serie</td><td style="text-align: right;">10.1</td></tr> <tr><td>Total</td><td style="text-align: right;">90.4</td></tr> </table>	Serie	10.1	Total	90.4	<p>6. Serie 1 Skud </p> <p>1: 9.8 ←</p> <table border="1" style="width:100%; border-collapse: collapse;"> <tr><td>Serie</td><td style="text-align: right;">9.8</td></tr> <tr><td>Total</td><td style="text-align: right;">100.2</td></tr> </table>	Serie	9.8	Total	100.2
Serie	10.1								
Total	90.4								
Serie	9.8								
Total	100.2								

<p>7. Serie 1 Skud </p> <p>1: 9.6 ↘</p> <table border="1" style="width:100%; border-collapse: collapse;"> <tr><td>Serie</td><td style="text-align: right;">9.6</td></tr> <tr><td>Total</td><td style="text-align: right;">109.8</td></tr> </table>	Serie	9.6	Total	109.8	
Serie	9.6				
Total	109.8				

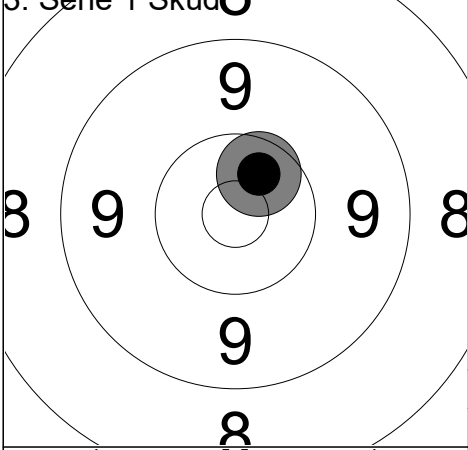
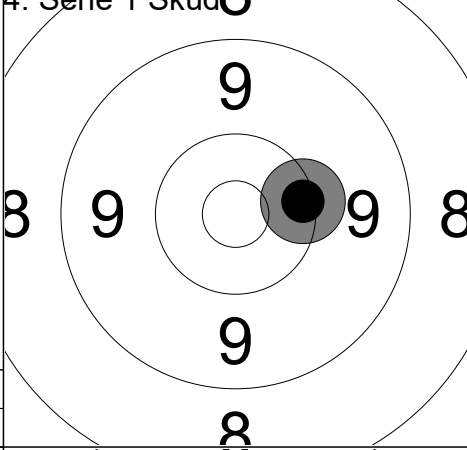
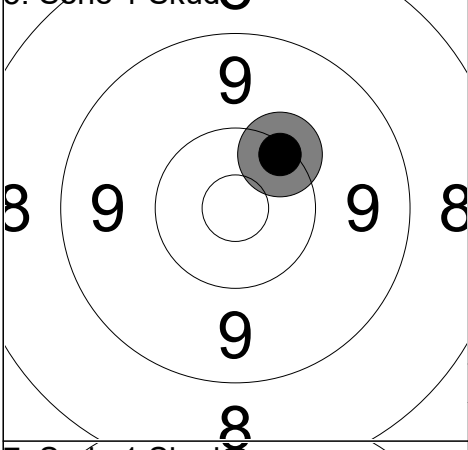
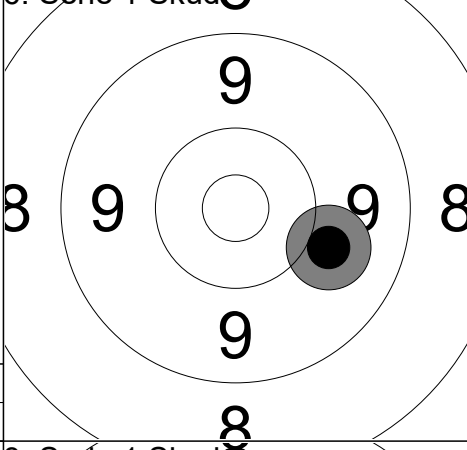
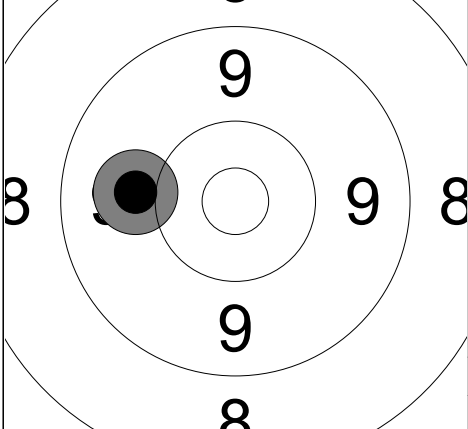
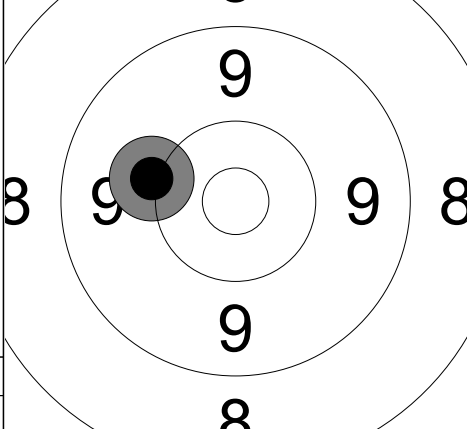
1. Serie 5 Skud 	1: 10.7x ← 2: 10.3 ↓ 3: 10.7x ← 4: 10.6x ↓ 5: 10.8x ↓	2. Serie 1 Skud 	1: 9.4 ↑								
	<table border="1" style="width: 100%; border-collapse: collapse;"> <tr> <td style="width: 50%;">Serie</td> <td style="text-align: right;">53.1</td> </tr> <tr> <td>Total</td> <td style="text-align: right;">53.1</td> </tr> </table>	Serie	53.1	Total	53.1	<table border="1" style="width: 100%; border-collapse: collapse;"> <tr> <td style="width: 50%;">Serie</td> <td style="text-align: right;">9.4</td> </tr> <tr> <td>Total</td> <td style="text-align: right;">62.5</td> </tr> </table>	Serie	9.4	Total	62.5	
Serie	53.1										
Total	53.1										
Serie	9.4										
Total	62.5										
3. Serie 1 Skud 	1: 10.5x ↗	4. Serie 1 Skud 	1: 10.3 →								
	<table border="1" style="width: 100%; border-collapse: collapse;"> <tr> <td style="width: 50%;">Serie</td> <td style="text-align: right;">10.5</td> </tr> <tr> <td>Total</td> <td style="text-align: right;">73.0</td> </tr> </table>	Serie	10.5	Total	73.0	<table border="1" style="width: 100%; border-collapse: collapse;"> <tr> <td style="width: 50%;">Serie</td> <td style="text-align: right;">10.3</td> </tr> <tr> <td>Total</td> <td style="text-align: right;">83.3</td> </tr> </table>	Serie	10.3	Total	83.3	
Serie	10.5										
Total	73.0										
Serie	10.3										
Total	83.3										
5. Serie 1 Skud 	1: 10.3 ↗	6. Serie 1 Skud 	1: 10.0 →								
	<table border="1" style="width: 100%; border-collapse: collapse;"> <tr> <td style="width: 50%;">Serie</td> <td style="text-align: right;">10.3</td> </tr> <tr> <td>Total</td> <td style="text-align: right;">93.6</td> </tr> </table>	Serie	10.3	Total	93.6	<table border="1" style="width: 100%; border-collapse: collapse;"> <tr> <td style="width: 50%;">Serie</td> <td style="text-align: right;">10.0</td> </tr> <tr> <td>Total</td> <td style="text-align: right;">103.6</td> </tr> </table>	Serie	10.0	Total	103.6	
Serie	10.3										
Total	93.6										
Serie	10.0										
Total	103.6										
7. Serie 1 Skud 	1: 10.0 ←	8. Serie 1 Skud 	1: 10.1 ←								
	<table border="1" style="width: 100%; border-collapse: collapse;"> <tr> <td style="width: 50%;">Serie</td> <td style="text-align: right;">10.0</td> </tr> <tr> <td>Total</td> <td style="text-align: right;">113.6</td> </tr> </table>	Serie	10.0	Total	113.6	<table border="1" style="width: 100%; border-collapse: collapse;"> <tr> <td style="width: 50%;">Serie</td> <td style="text-align: right;">10.1</td> </tr> <tr> <td>Total</td> <td style="text-align: right;">123.7</td> </tr> </table>	Serie	10.1	Total	123.7	
Serie	10.0										
Total	113.6										
Serie	10.1										
Total	123.7										

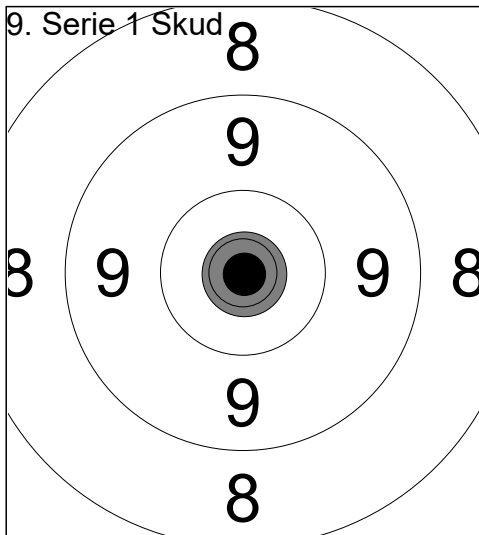

1: 10.9x ↘

Serie	10.9
Total	134.6

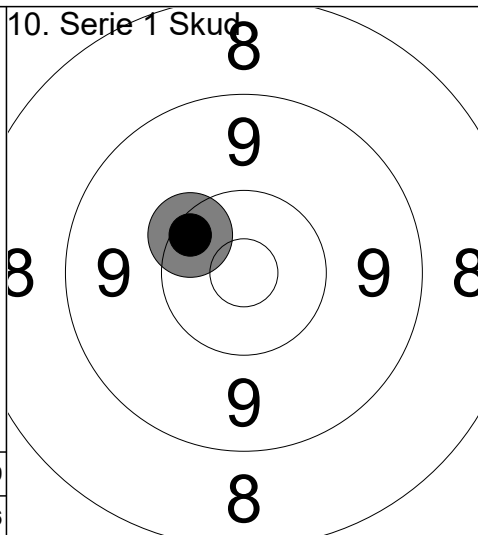

1: 10.3 ↖

Serie	10.3
Total	144.9

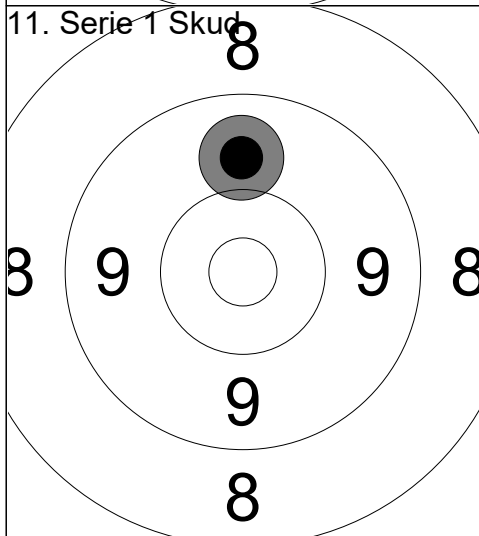

1: 9.8 ↑

Serie	9.8
Total	154.7

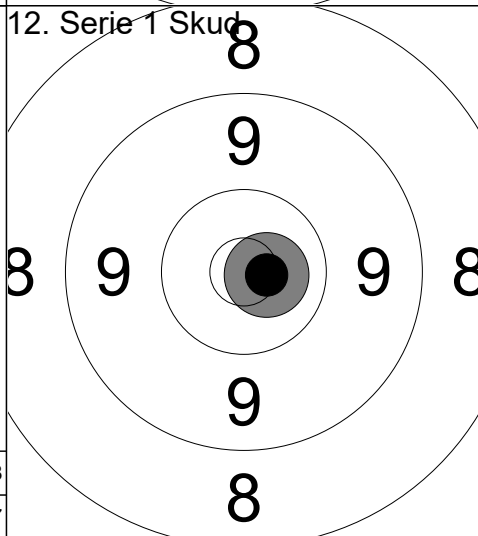

1: 10.7x →

Serie	10.7
Total	165.4

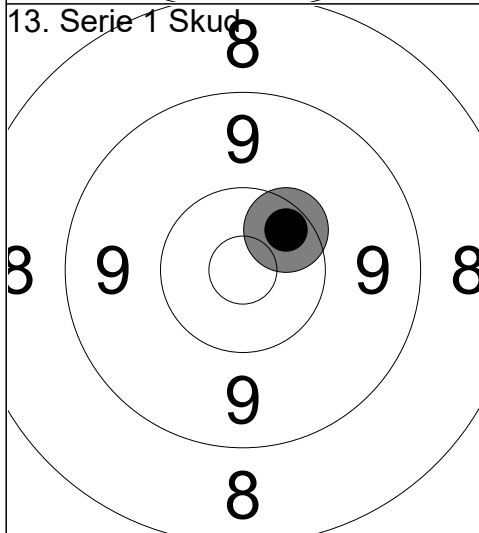





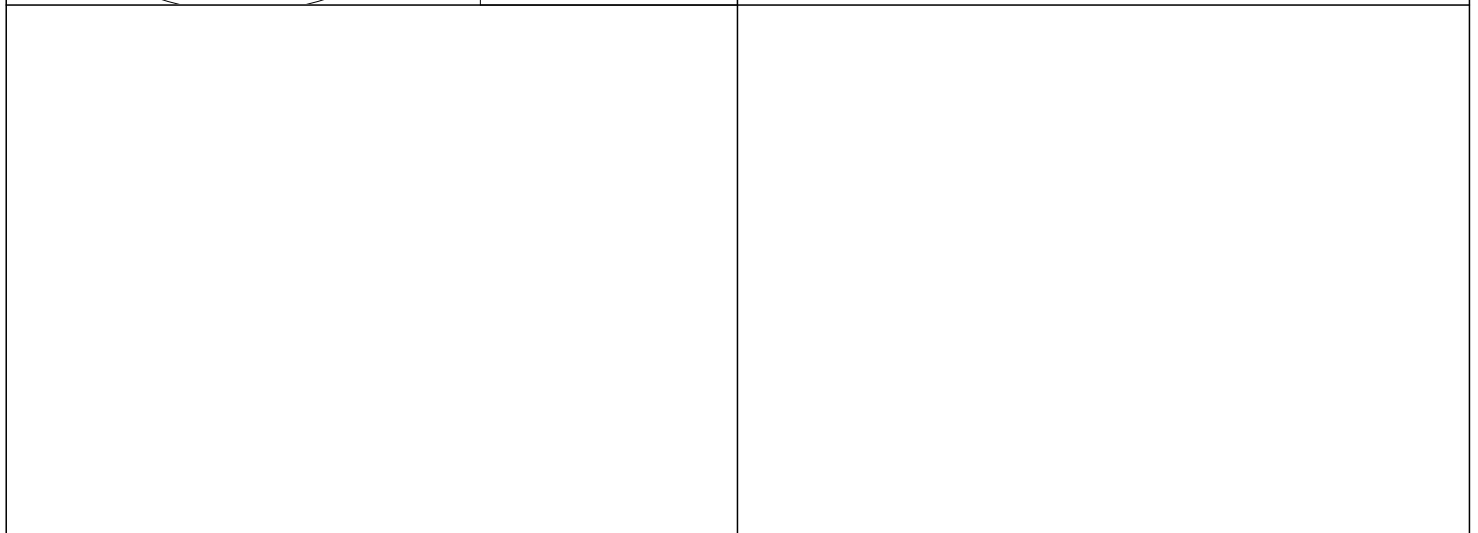



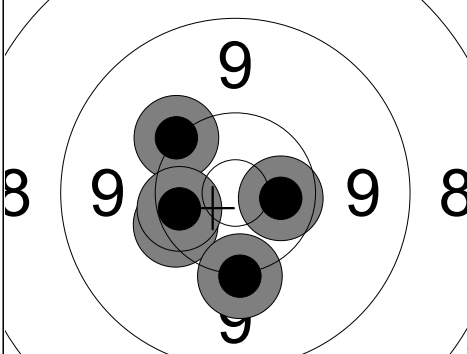

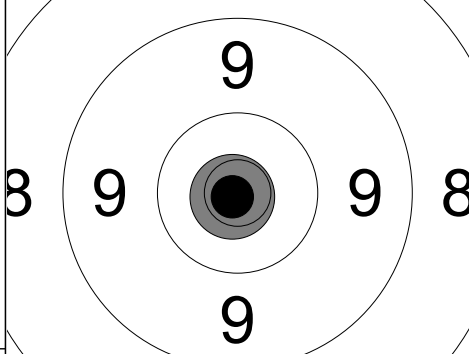

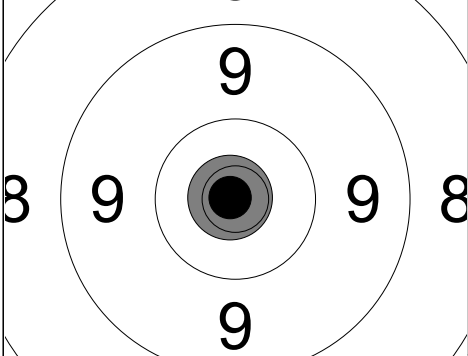

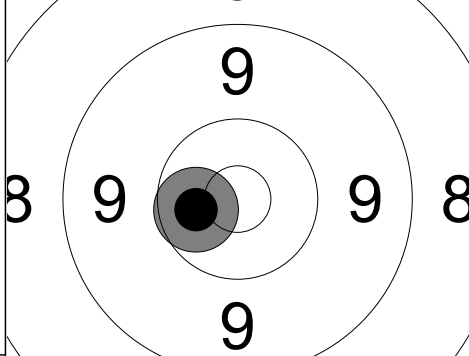
1: 10.4 ↗

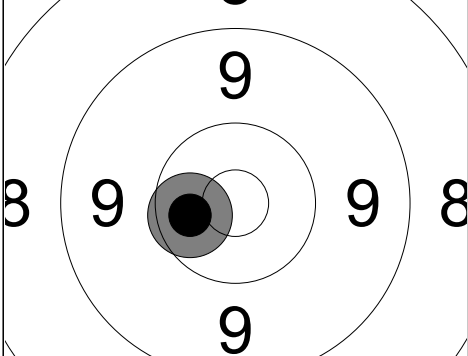
Serie	10.4
Total	175.8

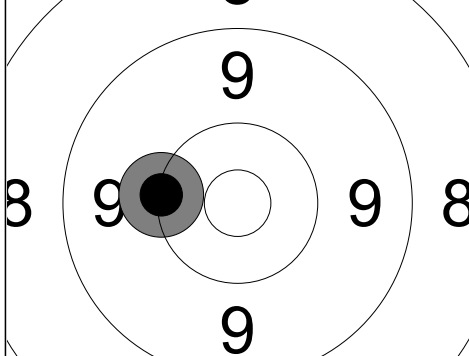

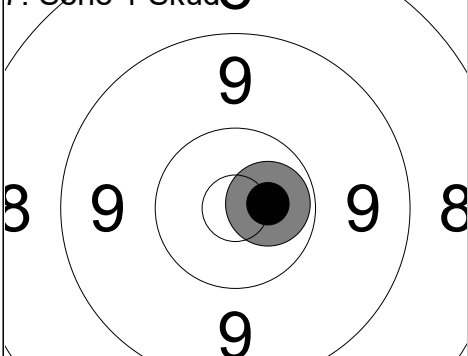
Hold 28	Skive 8	René Andersen	
50M		Ølstykke Skytteforening	FLIG
10.08.2024		EM 2024	Hanebjerg Skyttecenter
Kommentar		Signatur	

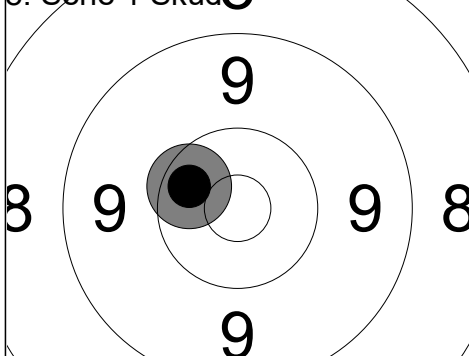
<p>1. Serie 5 Skud </p>  <table border="1" data-bbox="550 315 813 772"> <tr> <td>1:</td> <td>10.5x</td> <td>→</td> </tr> <tr> <td>2:</td> <td>10.2</td> <td>↗</td> </tr> <tr> <td>3:</td> <td>10.3</td> <td>↖</td> </tr> <tr> <td>4:</td> <td>10.4</td> <td>←</td> </tr> <tr> <td>5:</td> <td>10.1</td> <td>↓</td> </tr> <tr> <td colspan="2">Serie</td> <td>51.5</td> </tr> <tr> <td colspan="2">Total</td> <td>51.5</td> </tr> </table>	1:	10.5x	→	2:	10.2	↗	3:	10.3	↖	4:	10.4	←	5:	10.1	↓	Serie		51.5	Total		51.5	<p>2. Serie 1 Skud </p>  <table border="1" data-bbox="1284 315 1552 772"> <tr> <td>1:</td> <td>10.9x</td> <td>↙</td> </tr> <tr> <td colspan="2">Serie</td> <td>10.9</td> </tr> <tr> <td colspan="2">Total</td> <td>62.4</td> </tr> </table>	1:	10.9x	↙	Serie		10.9	Total		62.4
1:	10.5x	→																													
2:	10.2	↗																													
3:	10.3	↖																													
4:	10.4	←																													
5:	10.1	↓																													
Serie		51.5																													
Total		51.5																													
1:	10.9x	↙																													
Serie		10.9																													
Total		62.4																													
<p>3. Serie 1 Skud </p>  <table border="1" data-bbox="550 772 813 1232"> <tr> <td>1:</td> <td>10.9x</td> <td>↖</td> </tr> <tr> <td colspan="2">Serie</td> <td>10.9</td> </tr> <tr> <td colspan="2">Total</td> <td>73.3</td> </tr> </table>	1:	10.9x	↖	Serie		10.9	Total		73.3	<p>4. Serie 1 Skud </p>  <table border="1" data-bbox="1284 772 1552 1232"> <tr> <td>1:</td> <td>10.5x</td> <td>↖</td> </tr> <tr> <td colspan="2">Serie</td> <td>10.5</td> </tr> <tr> <td colspan="2">Total</td> <td>83.8</td> </tr> </table>	1:	10.5x	↖	Serie		10.5	Total		83.8												
1:	10.9x	↖																													
Serie		10.9																													
Total		73.3																													
1:	10.5x	↖																													
Serie		10.5																													
Total		83.8																													
<p>5. Serie 1 Skud </p>  <table border="1" data-bbox="550 1232 813 1691"> <tr> <td>1:</td> <td>10.5x</td> <td>↖</td> </tr> <tr> <td colspan="2">Serie</td> <td>10.5</td> </tr> <tr> <td colspan="2">Total</td> <td>94.3</td> </tr> </table>	1:	10.5x	↖	Serie		10.5	Total		94.3	<p>6. Serie 1 Skud </p>  <table border="1" data-bbox="1284 1232 1552 1691"> <tr> <td>1:</td> <td>10.2</td> <td>↖</td> </tr> <tr> <td colspan="2">Serie</td> <td>10.2</td> </tr> <tr> <td colspan="2">Total</td> <td>104.5</td> </tr> </table>	1:	10.2	↖	Serie		10.2	Total		104.5												
1:	10.5x	↖																													
Serie		10.5																													
Total		94.3																													
1:	10.2	↖																													
Serie		10.2																													
Total		104.5																													
<p>7. Serie 1 Skud </p>  <table border="1" data-bbox="550 1691 813 2150"> <tr> <td>1:</td> <td>10.6x</td> <td>→</td> </tr> <tr> <td colspan="2">Serie</td> <td>10.6</td> </tr> <tr> <td colspan="2">Total</td> <td>115.1</td> </tr> </table>	1:	10.6x	→	Serie		10.6	Total		115.1	<p>8. Serie 1 Skud </p>  <table border="1" data-bbox="1284 1691 1552 2150"> <tr> <td>1:</td> <td>10.4x</td> <td>↖</td> </tr> <tr> <td colspan="2">Serie</td> <td>10.4</td> </tr> <tr> <td colspan="2">Total</td> <td>125.5</td> </tr> </table>	1:	10.4x	↖	Serie		10.4	Total		125.5												
1:	10.6x	→																													
Serie		10.6																													
Total		115.1																													
1:	10.4x	↖																													
Serie		10.4																													
Total		125.5																													

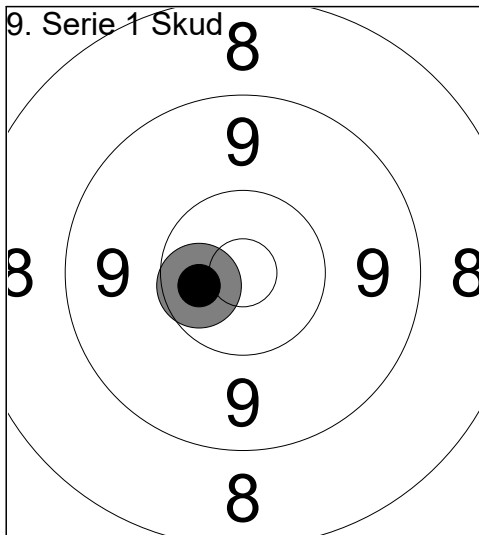

1: 10.5x ↙

Serie	10.5
Total	136.0

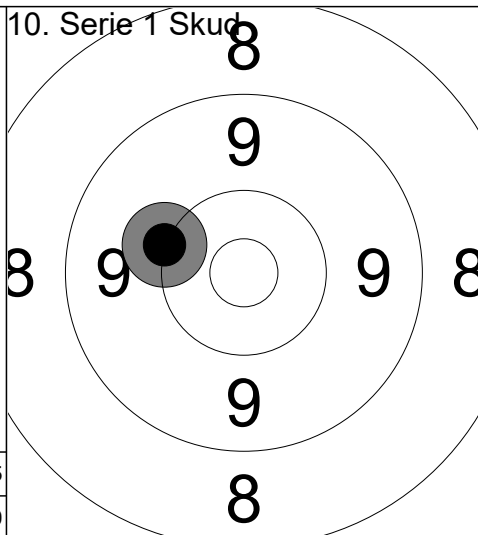

1: 10.1 ↙

Serie	10.1
Total	146.1

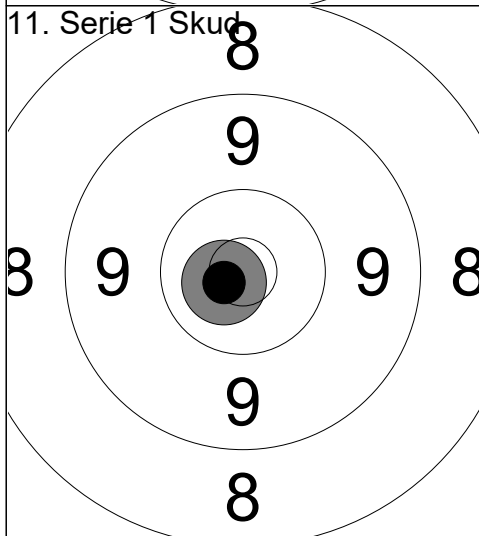

1: 10.7x ↙

Serie	10.7
Total	156.8

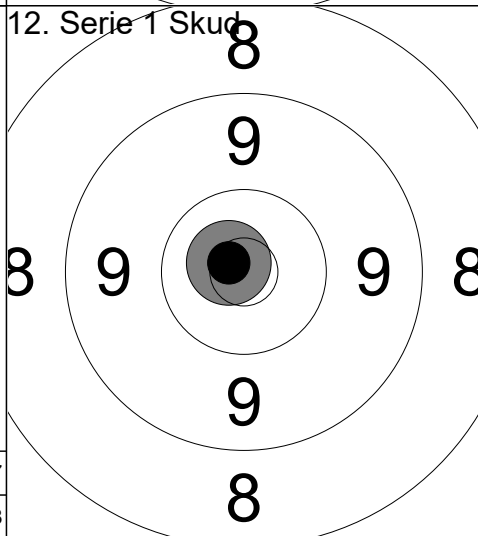

1: 10.8x ↖

Serie	10.8
Total	167.6

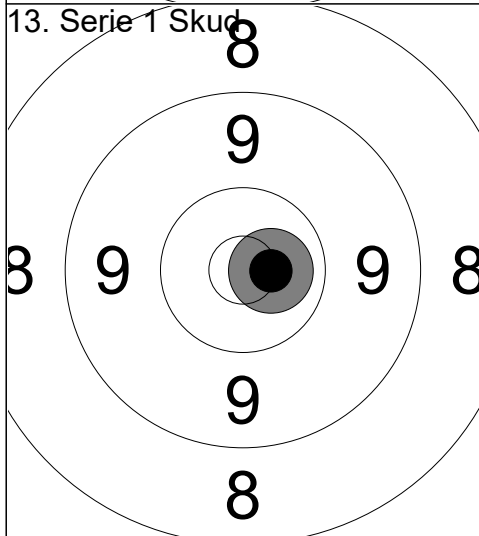

1: 10.7x →

Serie	10.7
Total	178.3

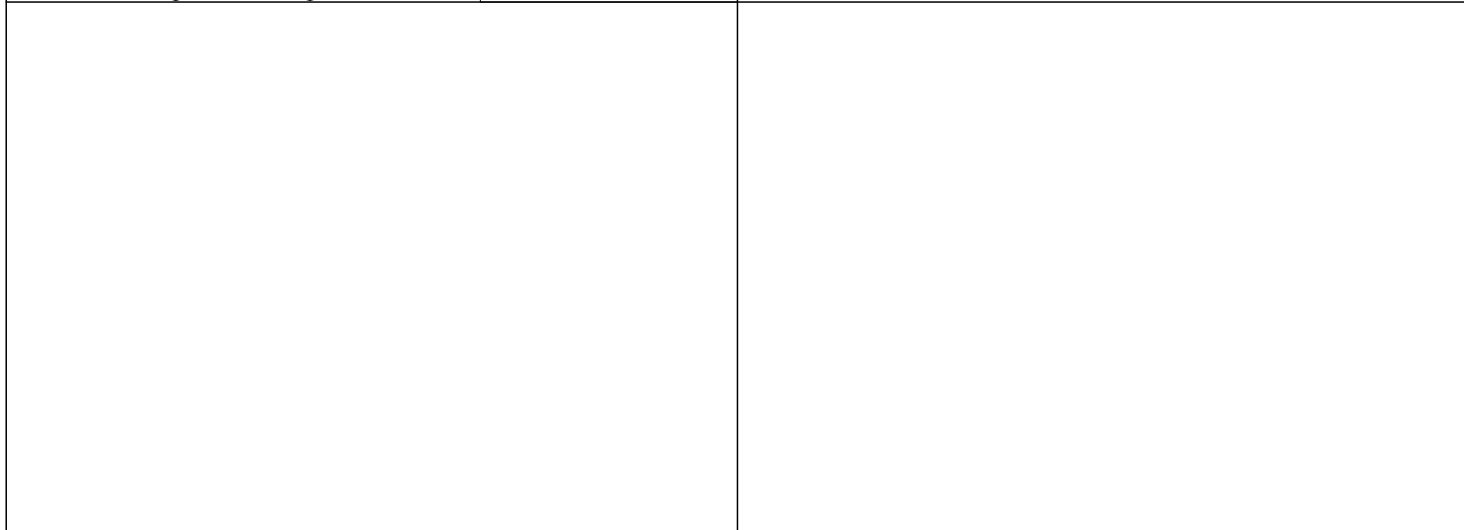

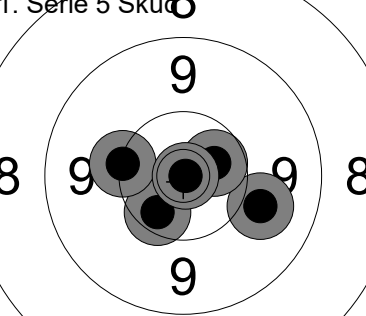
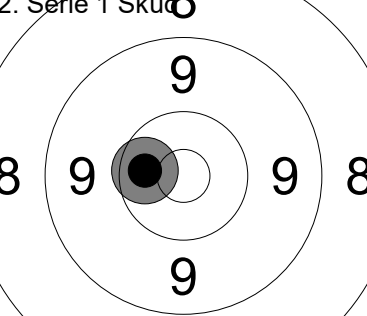
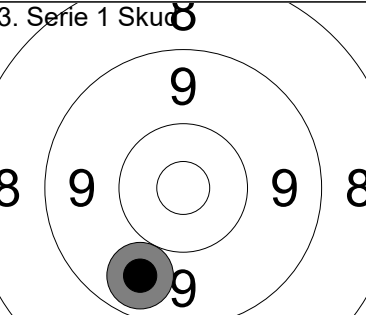
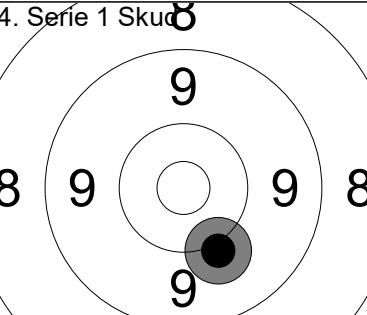
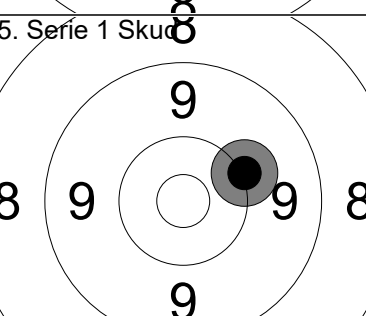
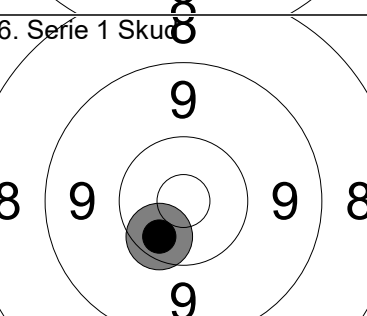
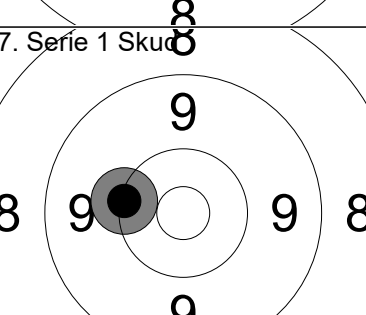
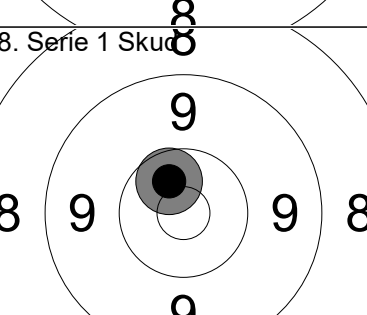
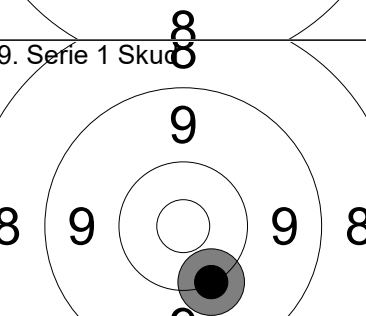
<p>1. Serie 5 Skud</p> 	<p>1: 10.4 ↙ 2: 9.9 → 3: 10.2 ← 4: 10.5x → 5: 10.9x →</p>	<p>2. Serie 1 Skud</p> 	<p>1: 10.5x ←</p>								
	<table border="1" style="width:100%; border-collapse: collapse;"> <tr><td>Serie</td><td style="text-align: right;">51.9</td></tr> <tr><td>Total</td><td style="text-align: right;">51.9</td></tr> </table>	Serie	51.9	Total	51.9		<table border="1" style="width:100%; border-collapse: collapse;"> <tr><td>Serie</td><td style="text-align: right;">10.5</td></tr> <tr><td>Total</td><td style="text-align: right;">62.4</td></tr> </table>	Serie	10.5	Total	62.4
Serie	51.9										
Total	51.9										
Serie	10.5										
Total	62.4										
<p>3. Serie 1 Skud</p> 	<p>1: 9.7 ↙</p>	<p>4. Serie 1 Skud</p> 	<p>1: 10.1 ↘</p>								
	<table border="1" style="width:100%; border-collapse: collapse;"> <tr><td>Serie</td><td style="text-align: right;">9.7</td></tr> <tr><td>Total</td><td style="text-align: right;">72.1</td></tr> </table>	Serie	9.7	Total	72.1		<table border="1" style="width:100%; border-collapse: collapse;"> <tr><td>Serie</td><td style="text-align: right;">10.1</td></tr> <tr><td>Total</td><td style="text-align: right;">82.2</td></tr> </table>	Serie	10.1	Total	82.2
Serie	9.7										
Total	72.1										
Serie	10.1										
Total	82.2										
<p>5. Serie 1 Skud</p> 	<p>1: 10.1 →</p>	<p>6. Serie 1 Skud</p> 	<p>1: 10.4x ↘</p>								
	<table border="1" style="width:100%; border-collapse: collapse;"> <tr><td>Serie</td><td style="text-align: right;">10.1</td></tr> <tr><td>Total</td><td style="text-align: right;">92.3</td></tr> </table>	Serie	10.1	Total	92.3		<table border="1" style="width:100%; border-collapse: collapse;"> <tr><td>Serie</td><td style="text-align: right;">10.4</td></tr> <tr><td>Total</td><td style="text-align: right;">102.7</td></tr> </table>	Serie	10.4	Total	102.7
Serie	10.1										
Total	92.3										
Serie	10.4										
Total	102.7										
<p>7. Serie 1 Skud</p> 	<p>1: 10.2 ←</p>	<p>8. Serie 1 Skud</p> 	<p>1: 10.5x ↗</p>								
	<table border="1" style="width:100%; border-collapse: collapse;"> <tr><td>Serie</td><td style="text-align: right;">10.2</td></tr> <tr><td>Total</td><td style="text-align: right;">112.9</td></tr> </table>	Serie	10.2	Total	112.9		<table border="1" style="width:100%; border-collapse: collapse;"> <tr><td>Serie</td><td style="text-align: right;">10.5</td></tr> <tr><td>Total</td><td style="text-align: right;">123.4</td></tr> </table>	Serie	10.5	Total	123.4
Serie	10.2										
Total	112.9										
Serie	10.5										
Total	123.4										
<p>9. Serie 1 Skud</p> 	<p>1: 10.2 ↘</p>										
	<table border="1" style="width:100%; border-collapse: collapse;"> <tr><td>Serie</td><td style="text-align: right;">10.2</td></tr> <tr><td>Total</td><td style="text-align: right;">133.6</td></tr> </table>	Serie	10.2	Total	133.6						
Serie	10.2										
Total	133.6										

Hold 28	Skive 10	Stefan Misfeldt Kvist-Andersen
-------------------	--------------------	---------------------------------------

50M	Ganløse Skytteforening	FLIG
-----	------------------------	------

10.08.2024	EM 2024	Hanebjerg Skyttecenter
------------	---------	------------------------

Kommentar	Signatur
-----------	----------

<p>1. Serie 5 Skud </p> <table border="1" style="width:100%; border-collapse: collapse; margin-top: 10px;"> <tr><td>Serie</td><td style="text-align: right;">50.6</td></tr> <tr><td>Total</td><td style="text-align: right;">50.6</td></tr> </table>	Serie	50.6	Total	50.6	<p>2. Serie 1 Skud </p> <table border="1" style="width:100%; border-collapse: collapse; margin-top: 10px;"> <tr><td>Serie</td><td style="text-align: right;">9.8</td></tr> <tr><td>Total</td><td style="text-align: right;">60.4</td></tr> </table>	Serie	9.8	Total	60.4	<p>1: 10.0 ↘</p> <p>2: 10.5x ←</p> <p>3: 10.4x →</p> <p>4: 9.3 ↘</p> <p>5: 10.4 ↗</p>
Serie	50.6									
Total	50.6									
Serie	9.8									
Total	60.4									

<p>3. Serie 1 Skud </p> <table border="1" style="width:100%; border-collapse: collapse; margin-top: 10px;"> <tr><td>Serie</td><td style="text-align: right;">10.0</td></tr> <tr><td>Total</td><td style="text-align: right;">70.4</td></tr> </table>	Serie	10.0	Total	70.4	<p>4. Serie 1 Skud </p> <table border="1" style="width:100%; border-collapse: collapse; margin-top: 10px;"> <tr><td>Serie</td><td style="text-align: right;">10.1</td></tr> <tr><td>Total</td><td style="text-align: right;">80.5</td></tr> </table>	Serie	10.1	Total	80.5	<p>1: 10.0 ←</p>
Serie	10.0									
Total	70.4									
Serie	10.1									
Total	80.5									

<p>5. Serie 1 Skud </p> <table border="1" style="width:100%; border-collapse: collapse; margin-top: 10px;"> <tr><td>Serie</td><td style="text-align: right;">10.2</td></tr> <tr><td>Total</td><td style="text-align: right;">90.7</td></tr> </table>	Serie	10.2	Total	90.7	<p>6. Serie 1 Skud </p> <table border="1" style="width:100%; border-collapse: collapse; margin-top: 10px;"> <tr><td>Serie</td><td style="text-align: right;">10.4</td></tr> <tr><td>Total</td><td style="text-align: right;">101.1</td></tr> </table>	Serie	10.4	Total	101.1	<p>1: 10.2 ↘</p>
Serie	10.2									
Total	90.7									
Serie	10.4									
Total	101.1									

<p>7. Serie 1 Skud </p> <table border="1" style="width:100%; border-collapse: collapse; margin-top: 10px;"> <tr><td>Serie</td><td style="text-align: right;">9.8</td></tr> <tr><td>Total</td><td style="text-align: right;">110.9</td></tr> </table>	Serie	9.8	Total	110.9		<p>1: 9.8 ↗</p>
Serie	9.8					
Total	110.9					

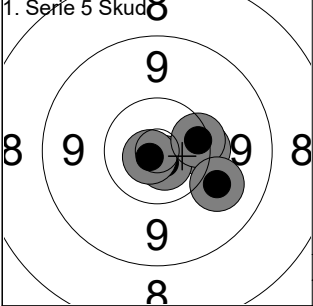
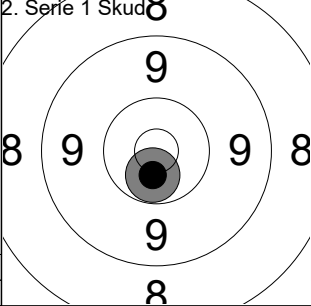
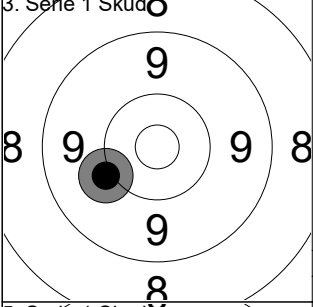
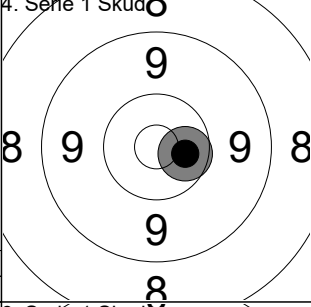
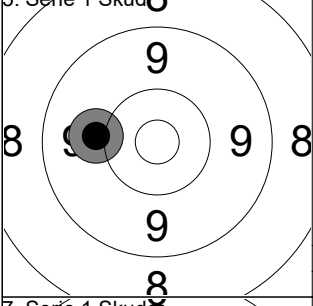
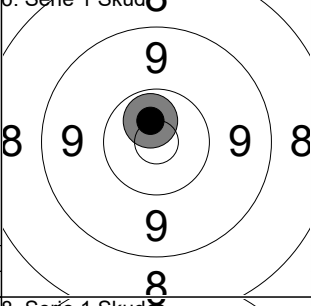
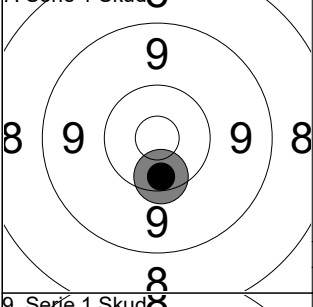
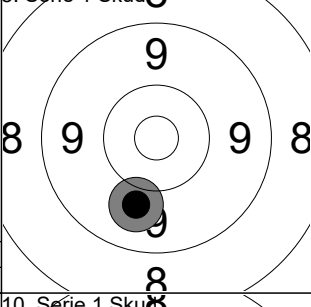
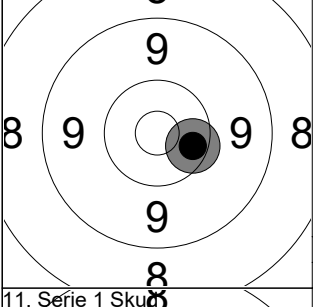
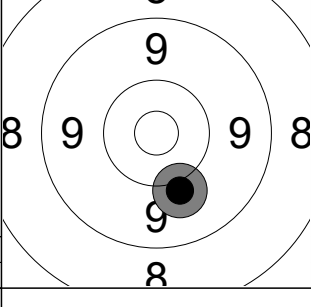
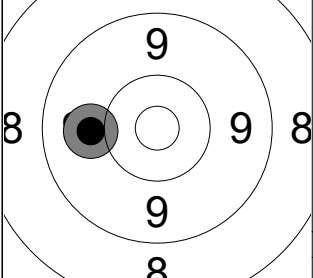
1. Serie 5 Skud 	1: 10.3 2: 10.7x 3: 10.8x 4: 10.3 5: 9.9	2. Serie 1 Skud 	1: 10.6x
	Serie 52.0 Total 52.0		Serie 10.6 Total 62.6
3. Serie 1 Skud 	1: 10.1	4. Serie 1 Skud 	1: 10.5x
	Serie 10.1 Total 72.7		Serie 10.5 Total 83.2
5. Serie 1 Skud 	1: 10.0	6. Serie 1 Skud 	1: 10.6x
	Serie 10.0 Total 93.2		Serie 10.6 Total 103.8
7. Serie 1 Skud 	1: 10.4	8. Serie 1 Skud 	1: 9.9
	Serie 10.4 Total 114.2		Serie 9.9 Total 124.1
9. Serie 1 Skud 	1: 10.4	10. Serie 1 Skud 	1: 10.0
	Serie 10.4 Total 134.5		Serie 10.0 Total 144.5
11. Serie 1 Skud 	1: 10.0		
	Serie 10.0 Total 154.5		

<p>1. Serie 5 Skud</p>	<p>1: 9.2 ↓ 2: 9.5 ↓ 3: 10.6x ↓ 4: 10.3 ↗ 5: 10.4x ←</p>	<p>2. Serie 1 Skud</p>
Serie 50.0		Serie 9.8
Total 50.0		Total 59.8

<p>3. Serie 1 Skud</p>	<p>1: 9.7 ↓</p>	<p>4. Serie 1 Skud</p>
Serie 9.7		Serie 9.9
Total 69.5		Total 79.4

<p>5. Serie 1 Skud</p>	<p>1: 10.3 ↓</p>	
Serie 10.3		
Total 89.7		